

**THE SYSTEM OPERATOR
TRANSMISSION OWNER
CODE (STC)**

THE SYSTEM OPERATOR TRANSMISSION OWNER CODE (STC)

CONTENTS*

SECTIONS

SECTION A APPLICABILITY OF SECTIONS AND CODE STRUCTURE

SECTION B GOVERNANCE

SECTION C TRANSMISSION SERVICES AND OPERATIONS

PART 1 Provision of Transmission Services

PART 2 Transmission Outage Planning

PART 3 Other

SECTION D PLANNING CO-ORDINATION

PART 1 Transmission Planning

PART 2 Construction

PART 3 Tec Exchange

PART 4 Statement of Works Process

SECTION E PAYMENTS AND BILLING

SECTION F COMMUNICATIONS AND DATA

SECTION G GENERAL PROVISIONS

SECTION H DISPUTE RESOLUTION

SECTION I TRANSITION

SECTION J INTERPRETATION AND DEFINITIONS

**SECTION K TECHNICAL, DESIGN AND OPERATIONAL CRITERIA AND PERFORMANCE
REQUIREMENTS FOR OFFSHORE TRANSMISSION SYSTEMS**

SCHEDULES

**SCHEDULE 1 THE SYSTEM OPERATOR - TRANSMISSION OWNER CODE ACCESSION
AGREEMENT**

SCHEDULE 2 LIST OF CODE PROCEDURES

SCHEDULE 3 INFORMATION AND DATA EXCHANGE SPECIFICATION

**SCHEDULE 4 CRITERIA FOR ASSESSING THOSE TRANSMISSION SYSTEMS AFFECTED
BY A CONSTRUCTION PROJECT**

SCHEDULE 5 NGET CONNECTION APPLICATIONS

SCHEDULE 6 NGET MODIFICATION APPLICATIONS

SCHEDULE 7 SYSTEM CONSTRUCTION APPLICATIONS

SCHEDULE 8 TO CONSTRUCTION OFFER

SCHEDULE 9 TO CONSTRUCTION TERMS

SCHEDULE 10 CHARGES

PART 1 TO GENERAL SYSTEM CHARGES

PART 2 TO SITE-SPECIFIC CHARGES

PART 3 OTHER CHARGES

PART 4 INTERRUPTION CHARGES

PART 5 OFFSHORE TRANSMISSION OWNER OF LAST RESORT CHARGES

PART 6 OFFSHORE CONSTRUCTION SECURITIES

PART 7 OFFSHORE COMPENSATION PAYMENTS

PART 8 REPLACEMENT OFFSHORE TRANSMISSION OWNER CHARGES

SCHEDULE 11 NGET TEC EXCHANGE RATE APPLICATIONS

SCHEDULE 12 TO TEC EXCHANGE RATES

SCHEDULE 13 NGET REQUESTS FOR STATEMENTS OF WORKS

SCHEDULE 14 NOT IN USE

SCHEDULE 15 TRANSMISSION INTERFACE AGREEMENT

SCHEDULE A LIST OF PARTIES

*does not constitute part of the System Operator Transmission Owner Code (STC)

SECTION A: APPLICABILITY OF SECTIONS AND CODE STRUCTURE

1. INTRODUCTION

1.1 This Section A sets out:

1.1.1 the structure of the Code;

1.1.2 the definition of Code Procedures and an explanation of their relationship with other parts of the Code;

1.1.3 provisions relating to publication of and access to the Code;

1.1.4 the relationship of the Code with other documents.

2. STRUCTURE OF THE CODE

2.1 The Code

2.1.1 The Code comprises each of the sub-paragraphs, paragraphs, Parts, Sections, Schedules, and Code Procedures.

2.2 TO Construction Agreements

2.2.1 Each TO Construction Agreement contemplated to be entered into pursuant to Section D, Part Two of this Code shall, unless otherwise agreed between the Parties to such TO Construction Agreement, contain the terms, or contain terms substantially in the same form as, those set out in Schedule Nine.

2.2.2 Each TO Construction Agreement entered into pursuant to Section D, Part Two of this Code and in force from time to time shall constitute a separate agreement governed by the terms of this Code and will be read and construed accordingly.

2.3 Code Procedures

2.3.1 The Code Procedures form a part of the Code and set down processes and procedures that the Relevant Parties consider and agree are appropriate to support their compliance with the rest of the Code.

2.3.2 The Code Procedures shall be those listed in Schedule Two which Schedule shall be updated from time to time in accordance with Section B, paragraph 7.3.

2.3.3 Unless otherwise specified, a reference in other parts of the Code (including, for the avoidance of doubt, in any other Code Procedure) to a Code Procedure shall be deemed to be a reference to the version of that Code Procedure then in force as indicated in the then current version of Schedule Two.

2.3.4 Each Relevant Party shall comply with the Code Procedures where and to the extent that such Code Procedures relate to such Relevant Party.

2.3.5 Code Procedures may be amended and new Code Procedures created in accordance with Section B, paragraph 7.3.

3. ACCESS TO THE CODE

- 3.1 Subject to paragraph 3.3, a copy of the Code shall be published on the Code Website.
- 3.2 Notwithstanding paragraph 3.1 and subject always to paragraph 3.3, the Panel Secretary shall provide a copy of the Code (including, for the avoidance of doubt, any Code Procedure) or any past versions of same, to any person on request, which may be subject (other than in the case of the Authority) to payment by such person of a reasonable charge. A reasonable charge shall be an amount not exceeding the reasonable cost to the Panel Secretary of making and providing such copy.
- 3.3 A Code Procedure, or part(s) thereof, may not be published or otherwise made available to other Parties, any third person or communicated to the public, including by publication on the Code Website or otherwise, where Relevant Parties agree that the disclosure of the contents of such Code Procedure, or part(s) thereof (including, without limitation, names and personal contact details) would substantially prejudice the interests of such Relevant Parties or persons identified therein and have notified the Parties, Panel Secretary and the Authority to this effect.
- 3.4 The Panel Secretary shall maintain and keep up to date a library of all past and current versions of the Code (including, for the avoidance of doubt, of each Code Procedure).

4. PRECEDENCE

- 4.1 In the event of any inconsistency between the provisions of a Code Procedure and any other parts of the Code that are not Code Procedures then such other parts of the Code shall prevail.
- 4.2 In the event of any inconsistency between the provisions of the Code and the provisions of any other document established or adopted under and pursuant to the Code then the provisions of the Code shall prevail.
- 4.3 In the event of any inconsistency between the provisions of one Code Procedure and another, the Relevant Parties to such Code Procedures as are inconsistent shall agree which provision(s) shall take precedence pending amendment of the Code Procedure(s) as relevant under Section B paragraph 7.3, and such Relevant Parties shall promptly take such steps in accordance with Section B paragraph 7.3 to remove such inconsistency.
- 4.4 A Party may refer a failure to agree pursuant to paragraph 4.3 to the Authority as a Dispute pursuant to Section H, paragraph 4.1.
- 4.5 The provisions of this paragraph 4 shall be subject to any express provision to the contrary in any part of the Code not contained in a Code Procedure.

SECTION B: GOVERNANCE

1. INTRODUCTION

1.1 This Section B sets out:

1.1.1 arrangements for admission of Transmission Licensees and Offshore Transmission Owners as Parties to the Code;

1.1.2 arrangements for withdrawal of Parties from the Code;

1.1.3 arrangements for the establishment and operation of the STC Modification Panel;

1.1.4 arrangements for the appointment of Party Representatives; and

1.1.5 procedures for making amendments to the Code.

2. PARTIES AND PARTY REPRESENTATIVE

2.1 For the purposes of this Code, a "**Party**" is a person who is, for the time being, bound by the Code by virtue of being a Party to the Framework Agreement;

2.2 For the purposes of this Code, a '**Party Representative**' is a representative of the Parties, appointed in accordance with paragraph 6.1.2 to act on behalf of them for the purposes of this Section B.

2.3 For the purposes of this Code, a '**Relevant Party**' is as defined in Section J of this Code.

2.4 For the purposes of the Code, a '**Relevant Party Representative**' is a representative of the Relevant Parties

3. ADMISSION OF NEW PARTIES

3.1 Accession Procedure for Party Applicants

3.1.1 Only a Party Applicant which is obliged from time to time to enter into the Framework Agreement shall have the right to enter into and be a Party to the Framework Agreement subject to, and in accordance with, the provisions of this paragraph 3.

3.1.2 A Party Applicant shall submit to the Panel Secretary:

3.1.2.1 an application form which is in such form as the Party Representatives may from time to time prescribe, giving its Party Details as at the time of its application, together with any supporting documentation so prescribed; and

- 3.1.2.2 a written undertaking from the Party Applicant (in the form prescribed in the application form) that the Party Details of such Party Applicant are complete and accurate in all material respects.
- 3.1.3 Upon receipt of the items referred to in sub-paragraph 3.1.2, the Panel Secretary shall promptly:
- 3.1.3.1 check that the application form has been duly completed by the Party Applicant and the relevant supporting documentation has been provided and, where necessary, liaise with the Party Applicant in order to ensure that the Party Applicant completes the application form and provides any such supporting documentation required;
 - 3.1.3.2 notify the Authority of the name of the Party Applicant;
 - 3.1.3.3 prepare an Accession Agreement for execution by the Party Applicant;
 - 3.1.3.4 execute and deliver such Accession Agreement on behalf of all Parties to the Party Applicant for execution;
 - 3.1.3.5 send a certified copy of such Accession Agreement, duly executed by the Party Applicant, to the Party Applicant and other Parties; and
 - 3.1.3.6 give notice of the accession of such Party Applicant to the Authority.
- 3.1.4 Subject to and in accordance with the provisions of this paragraph 3.1, each Party hereby irrevocably and unconditionally authorises the Panel Secretary to execute and deliver an Accession Agreement to a Party Applicant on its behalf and to admit the Party Applicant as a Party.
- 3.1.5 Accession of a Party Applicant to the Framework Agreement shall be effective on and from the date of the Accession Agreement.

3.2 **Party Entry Processes**

- 3.2.1 Following accession to the Framework Agreement under sub-paragraph 3.1.5, a Party Applicant shall be a Party save that the rights and obligations of such Party and the rights and obligations of the other Parties in respect of such Party under Sections C, D, K and paragraphs 2.2 and 3 of Section G of this Code shall not take effect, unless and to the extent it is expressly provided for in this Code or otherwise agreed between the Party Representatives, until the date of notification of completion of the Party Entry Processes (as defined in sub-paragraph 3.2.3 below) for that Party under sub-paragraph 3.2.4.
- 3.2.2 For the avoidance of doubt, where this Code provides for agreement to be made between the Party Representatives, on acceding to the Framework Agreement, a Party shall be deemed to agree with any and all decisions that have been reached by the Party Representatives prior to the date of the relevant Accession Agreement until such time as the Party Representatives shall otherwise agree.

- 3.2.3 As soon as reasonably practicable, but in any event not more than 30 days following the accession of a Party to the Framework Agreement under sub-paragraph 3.1.5, each Party and Party Representative shall use their reasonable endeavours to agree the procedures, processes and steps required to be taken by each of the Parties (such agreement not to be unreasonably withheld) such that each Party can comply and continue to comply with its obligations under this Code including any obligations or rights referred to in sub-paragraph 3.2.1 (here referred to as the “**Party Entry Processes**”) on and from the date of notification of completion of such Party Entry Processes under sub-paragraph 3.2.4. The Party Entry Processes shall include, without limitation, the establishment and testing of communications arrangements, exchange of data, development and amendment of, creation or accession to (as appropriate) Services Capability Specification, Interface Agreements, TO Construction Agreements, Outages Proposals, Transmission Investment Plans and Code Procedures and such Party Entry Processes may be amended as required from time to time upon agreement by the Party Representatives (such agreement not to be unreasonably withheld). In the case of an Offshore Transmission Owner, the Party Entry Processes shall also include the submission and acceptance of a TO Construction Offer in accordance with Paragraphs 4 and 5 of Section D Part Two of this Code (or, where a User is undertaking OTSDUW Build, the issue by the Offshore Transmission Owner of an OTSDUW Completion Report in accordance with Paragraph 4 of Section D Part Two of this Code).
- 3.2.4 Each Party shall expeditiously undertake such actions as are required of it under and pursuant to the Party Entry Processes in order to give effect to the timely completion of the Party Entry Processes. Completion of the Party Entry Processes shall be deemed to take effect from the date of notification of such completion by the Panel Secretary to the Authority on behalf of the Parties following agreement by the Party Representatives as to such notice. For the avoidance of doubt, to the extent that any obligations or rights did not take effect under sub-paragraph 3.2.1 prior to and for the duration of the Party Entry Processes, such obligations or rights shall, from the date of notification of completion of the Party Entry Processes under this sub-paragraph 3.2.4, take effect and thereby apply to the relevant Party, or Parties as relevant, in their entirety.
- 3.2.5 A Party or Party Representative may refer a failure to agree pursuant to sub-paragraphs 3.2.1 to 3.2.4 or any other dispute in relation to the scope, content or performance of the Party Entry Processes, to the Authority as a Dispute in accordance with Section H, paragraph 4.1.
- 3.2.6 Prior to a person becoming a Party, the Party Representatives shall, if requested to do so by the Authority, take all reasonable steps to develop (in consultation with that person) the Party Entry Processes that could apply were that person to accede to the Framework Agreement, including, the identification of any proposals for the amendment of the Code in accordance with Section B, paragraph 7 that the Party Representatives may consider to be necessary for the purpose of the Party Entry Processes that might apply were that person to accede.

4. PARTY DETAILS

4.1 For the purposes of this Code, the "**Party Details**" of a Party, which shall include for the purposes of this paragraph 4, a Party Applicant, are the following details and documentation of the Party:

4.1.1 its full name and contact details;

4.1.2 the name, address, and facsimile number of the person for whose attention notices issued in accordance with Section G, paragraph 12 should be marked;

4.1.3 details for service of process;

4.1.4 a copy of its current Transmission Licence (in the case of an Offshore Transmission Owner a copy of the notice from the Authority shall be provided and following this a copy of its Transmission Licence shall be provided five Business Days after the grant of its Transmission Licence);

4.1.5 the Party's VAT registration number; and

4.1.6 its Party Category.

4.2 Each Party shall:

4.2.1 provide its Party Details to the Panel Secretary; and

4.2.2 ensure that its Party Details for the time being provided to the Panel Secretary remain accurate and complete in all material respects.

4.3 Without prejudice to the generality of paragraph 4.2, if at any time:

4.3.1 a Party wishes to change any of its contact details forming part of such Party Details; or

4.3.2 the Party Details of a Party otherwise cease for whatever reason to be accurate and complete in all material respects,

then such Party shall notify the Panel Secretary as soon as reasonably practicable (and, wherever possible, in advance of such change) and shall provide such further information and supporting documentation as the Panel Secretary may reasonably require to evidence such change.

4.4 The Panel Secretary shall:

4.4.1 maintain an up-to-date list of the contact details forming a part of the Party Details in respect of each of the Parties and ensure that such list is available on the Code Website;

- 4.4.2 upon receipt of Party Details from a Party pursuant to paragraph 4.2, make available such Party Details to each of the other Parties and the Authority. The Panel Secretary shall update Schedule A of this STC accordingly;
- 4.4.3 promptly update the Party Details pursuant to paragraph 4.3 and notify the Parties and the Authority of any such changes; and
- 4.4.4 fulfil the role of the Code Administrator for the STC Modification Panel, in which role it shall maintain, publish, review and (where appropriate) amend from time to time the Code Administration Code of Practice approved by the Authority in conjunction with other code administrators.

5. WITHDRAWAL

5.1 Procedure

- 5.1.1 Each Party (the "**Withdrawing Party**") shall be entitled to withdraw from the Framework Agreement (including pursuant to an assignment or transfer under Section G paragraph 6) and thereby cease to be a Party from the Withdrawal Date under sub-paragraph 5.1.4.
- 5.1.2 A Withdrawing Party shall give notice to the Panel Secretary, each of the other Parties and the Authority of its intention to withdraw from the Framework Agreement (a "**Withdrawal Notice**"), which Withdrawal Notice shall include a Proposed Withdrawal Date. In any case where a Party is notified that its Transmission Licence will be revoked, that Party shall be deemed to have issued a Withdrawal Notice on the date of such notice of revocation.
- 5.1.3 As soon as reasonably practicable following the date of issue of a Withdrawal Notice under sub-paragraph 5.1.2, each Party Representative shall use its reasonable endeavours to agree the procedures, processes and steps required to be taken by each of the Parties (such agreement not to be unreasonably withheld) such that a remaining Party would not be caused to be in breach of its obligations under the Code as a consequence of the withdrawal of the Withdrawing Party ("**Decommissioning Actions**") after the Withdrawal Date (as defined at sub-paragraph 5.1.4) and such Decommissioning Actions may be amended as required from time to time upon agreement by the Party Representatives (such agreement not to be unreasonably withheld).
- 5.1.4 Each Party shall expeditiously undertake such actions as are required of it under and pursuant to the Decommissioning Actions to give effect to their timely completion, following which, the Panel Secretary shall give notice to the Authority of the completion of such Decommissioning Actions on behalf of the Parties following agreement by the Party Representatives of such notice. Such notification shall specify the date upon which the Withdrawing Party shall withdraw from the Framework Agreement which date (subject to sub-paragraph 5.1.5) shall be referred to herein as the "**Withdrawal Date**".

- 5.1.5 A Withdrawing Party cannot withdraw from the Framework Agreement and thereby cease to be a Party to the Code until the Withdrawal Date or, if at such Withdrawal Date, the Withdrawing Party is subject to a Transmission Licence Condition by virtue of which it is required to be a Party and/or to comply with the Code or which would otherwise be infringed if the Withdrawing Party withdrew from the Framework Agreement. In such event, the Withdrawal Date shall be postponed to such date as it no longer applies. The Withdrawing Party shall notify the Authority of the date from which the Transmission Licence Condition no longer applies and copy such notice to each of the other Parties.
- 5.1.6 A Party may refer a failure to agree the Decommissioning Actions pursuant to sub-paragraph 5.1.3 or other dispute in relation to the scope, content or performance of the Decommissioning Actions as a Dispute to the Authority in accordance with Section H, paragraph 4.1.
- 5.1.7 Prior to the issue of a Withdrawal Notice, the Party Representatives shall, if requested to do so by the Authority, take all reasonable steps to develop the Decommissioning Actions that could apply upon issue of a Withdrawal Notice under sub-paragraph 5.1.2.

5.2 **Consequential Provisions**

- 5.2.1 Where a Withdrawing Party withdraws from the Framework Agreement and thereby ceases to be a Party pursuant to paragraph 5.1, the provisions of this paragraph 5.2 shall apply.
- 5.2.2 With effect from the Withdrawal Date (as amended under sub-paragraph 5.1.5 as appropriate):
 - 5.2.2.1 the Withdrawing Party shall, subject to the provisions of sub-paragraph 5.2.3, be automatically released and discharged from all of its obligations and liabilities under the Code (including, for the avoidance of doubt, relevant Code Procedures to which they are a Party and the Framework Agreement); and
 - 5.2.2.2 each other Party shall, subject to the provisions of sub-paragraph 5.2.3, be automatically released and discharged from all of its obligations and liabilities to the Withdrawing Party under the Code (including, for the avoidance of doubt, relevant Code Procedures to which they are a Party and the Framework Agreement).
- 5.2.3 Any release and discharge referred to in sub-paragraph 5.2.2 shall not extend to the rights and liabilities (whether actual, contingent, accrued or otherwise) of a Party as at the Withdrawal Date (whether or not the other Parties are aware of such rights and liabilities at the Withdrawal Date).
- 5.2.4 Save as provided in sub-paragraph 5.2.2, the Framework Agreement and Code shall, upon withdrawal of any Party, remain in full force and effect and binding on each of the other Parties.

5.2.5 Withdrawal of a Withdrawing Party from the Framework Agreement shall not affect and shall be without prejudice to any accrued rights or liabilities that such Withdrawing Party may have under the Code, which rights or liabilities shall continue to be governed by the terms of this Code and the provisions of Section A, paragraph 3 and Section F, paragraph 2 and this paragraph 5.2 shall survive the withdrawal of the Withdrawing Party from the Framework Agreement.

6. THE STC MODIFICATION PANEL

6.1 Establishment and composition

6.1.1 The Parties shall establish a panel ("**STC Modification Panel**") which shall be constituted in accordance with the further provisions of this paragraph 6.

6.1.2 The STC Modification Panel shall comprise of Party Representatives appointed as follows:

- The Company may appoint not more than two persons by giving notice of such appointment to the Panel Secretary, and may remove and re-appoint by notice.
- Each Onshore Transmission Owner may appoint not more than two persons by giving notice of such appointment to the Panel Secretary, and may remove and re-appoint by notice.
- Prior to 31st March 2011, Offshore Transmission Owners may appoint not more than two persons for the period up to 31st March 2011 by jointly giving notice of such appointment to the Panel Secretary. Effective from 1st April 2011 and there after, Offshore Transmission Owners may appoint not more than two persons in accordance with Annex B1.

and such Party Representatives shall attend each meeting of the STC Modification Panel ("**STC Modification Panel Meeting**").

6.1.3 The STC Modification Panel shall be assisted by a secretary ("**Panel Secretary**") who shall be a person appointed and provided by The Company. The Panel Secretary shall carry out such activities as are specified in this Code and as are otherwise agreed between the Party Representatives from time to time but shall not have a right to vote at any STC Modification Panel Meeting.

6.1.4 In addition to the Party Representatives and Panel Secretary, there shall be a chairperson of the STC Modification Panel who shall be appointed annually (or as otherwise agreed by the Party Representatives) by and with the agreement of the Party Representatives and who shall, taking into account the functions set out in sub-paragraph 6.3.2, carry out such activities as may be agreed between the Party Representatives from time to time but shall not have a right to vote at any STC Modification Panel Meeting ("**Panel Chairperson**").

- 6.1.5 The Authority shall be entitled to receive notice of, and to appoint one or more representatives to attend and speak at, any STC Modification Panel Meeting but, for the avoidance of doubt, such representatives shall not have a right to vote at any such STC Modification Panel Meeting.
- 6.1.6 Any person designated by the Authority under sub-paragraph 7.2.2.1(b) below shall be entitled to receive notice of, and to appoint up to two representatives to attend and speak at, any STC Modification Panel Meeting but, for the avoidance of doubt, such representative(s) shall not have a right to vote at any such STC Modification Panel Meeting and shall not be deemed to be Party Representatives.

6.1A Alternate Representatives

- 6.1A.1 At the same time that Party Representatives are appointed under paragraph 6.1.2, no more than 2 Alternate Representatives representing Offshore Transmission Owners may be appointed in accordance with the procedure set out in Annex B1.
- 6.1A.2 Such Alternate Representatives will form a group from which Party Representatives representing Offshore Transmission Owners may select a person to act as their alternate under this Paragraph 6.1A.
- 6.1A.3 A Party Representative representing Offshore Transmission Owners may appoint such an Alternate Representative to be their alternate for any one STC Modification Panel Meeting, and may remove a person so appointed as alternate, by giving notice of such appointment or removal to the Panel Secretary. A Party Representative must choose an Alternate Representative who has not been already chosen by another Party Representative for that STC Modification Panel Meeting. If there are no Alternate Representatives left who have not already been so chosen by another Party Representative, the Party Representative may choose as their alternate any Alternate Representative or other Party Representative who is not already acting as alternate for more than one Party Representative.
- 6.1A.4 All information to be sent by the Panel Secretary to Party Representatives pursuant to this Section B shall also be sent by the Panel Secretary to each Alternate Representative (whether or not currently selected as an alternate for a Party Representative) by electronic mail (where relevant details shall have been provided by each Alternate Representative).

6.1A.5 Alternates: General Provisions

- 6.1A.5.1 The appointment or removal by a Party Representative of an alternate shall be effective from the time when such notice is given to the Panel Secretary or (if later) the time specified in such notice.
- 6.1A.5.2 The Panel Secretary shall promptly notify all Party Representatives and Parties of appointment or removal by any Party Representative of any alternate and (where relevant details have been provided to the Panel Secretary) despatch by electronic mail shall fulfil this obligation.

6.1A.5.3 In accordance with paragraph 6.1A, an alternate may act as alternate for more than one Party Representative.

6.1A.6 Alternates: Rights, Cessation and References

6.1A.6.1 Where a Party Representative has appointed an alternate:

6.1.6.1.1 the alternate shall be entitled to receive notices of meetings of the STC Modification Panel unless the appointing Party Representative shall otherwise notify the Panel Secretary; and,

6.1.6.1.2 the alternate shall be entitled to attend, speak and vote at any meeting of the STC Modification Panel at which the Party Representative by whom they were appointed is not present, and at such meeting to exercise and discharge all of the functions, duties and powers of such Party Representative;

6.1.6.1.3 the alternate shall cast one vote for each Party Representative by whom they were appointed, in addition (where they are a Party Representative themselves) to their own vote;

6.1A.6.2 Paragraphs 6.3, 6.4 and 6.6 shall apply to the alternate as if they were the appointing Party Representative and a reference to a Party Representative elsewhere in this Code shall, unless the context otherwise requires, include their duly appointed alternate.

6.1A.6.3 For the avoidance of doubt, the appointing Party Representative shall not enjoy any of the rights transferred to the alternate at any meeting at which, or in relation to any matter on which, the alternate acts on their behalf.

6.1A.7 A person appointed as an alternate shall automatically cease to be such alternate:

6.1A.7.1 if the appointing Party Representative ceases to be a Party Representative;

6.1A.7.2 if any of the circumstances in Paragraph 6.1C.1(b) applies in relation to such person,

but, in the case of an Alternate Representative, shall continue to be an Alternate Representative available for appointment under paragraph 8.6.2

6.1B Term of Office

6.1B.1 The term of office of a Party Representative and Alternate Representatives in each case representing Offshore Transmission Owners shall be a period expiring on 31 March every year following the Offshore Go-Live Date and from 01 January 2017, a period expiring on 31 March every two years. A Party Representative and Alternate Representative shall be eligible for reappointment on expiry of their term of office.

6.1C Removal from Office

6.1C.1 A person shall cease to hold office as a Party Representative or an Alternate Representative.

- (a) upon expiry of their term of office unless re-appointed;
- (b) if they:
 - (i) resign from office by notice delivered to the Panel Secretary;
 - (ii) become bankrupt or make any arrangement or composition with their creditors generally;
 - (iii) are or may be suffering from mental disorder and either are admitted to hospital in pursuance of an application under the Mental Health Act 1983 or the Mental Health (Scotland) Act 1960 or an order is made by a court having jurisdiction in matters concerning mental disorder for their detention or for the appointment of a receiver, *curator bonis* or other person with respect to their property or affairs;
 - (iv) become prohibited by law from being a director of a company under the Companies Act 1985;
 - (v) die; or
 - (vi) are convicted on an indictable offence; or
- (c) if the STC Modification Panel resolves (and the Authority does not veto such resolution by notice in writing to the Panel Secretary within 15 Business Days) that they should cease to hold office on grounds of their serious misconduct;

6.1C.2 A STC Modification Panel resolution under Paragraph 6.1C.1(c) shall, notwithstanding any other paragraph, require the vote in favour of at least all Party Representatives less one (other than the Party Representative or Alternate Representative who is the subject of such resolution) and for these purposes an abstention shall count as a vote cast in favour of the resolution. A copy of any such resolution shall forthwith be sent to the Authority by the Panel Secretary.

6.1C.3 A person shall not qualify for appointment as a Party Representative or Alternate Representative if at the time of the proposed appointment they would be required by the above paragraph to cease to hold that office.

6.1C.4 The Panel Secretary shall give prompt notice to all Party Representatives, all Parties and the Authority of the appointment or re-appointment of any Party Representative or Alternate Representative or of any Party Representative or Alternate Representative ceasing to hold office and publication on the Code Website and (where relevant details are supplied to the Panel Secretary) despatch by electronic mail shall fulfil this obligation.

6.2 Functions of the STC Modification Panel and the Code Administrator's Role

- 6.2.1 The functions of the STC Modification Panel shall be the:
 - 6.2.1.1 evaluation and administration of amendments to the Code in accordance with the procedures set out in this Section B;
 - 6.2.1.2 review of the consequences of amendments to the Code;
 - 6.2.1.3 administration of the Code as specified in this Section B;
 - 6.2.1.4 establishment of joint working arrangements pursuant to sub-paragraph 7.2.9.1 below; and
 - 6.2.1.5 consideration of any changes to the Code Administrator Code of Practice that the Code Administrator considers appropriate to raise.
- 6.2.2 The STC Modification Panel shall endeavour at all times to perform its functions:
 - 6.2.2.1 in an efficient, economical and expeditious manner, taking account of the complexity, importance and urgency of particular STC Modification Proposals; and
 - 6.2.2.2 with a view to ensuring that the Code facilitates achievement of the Applicable STC Objectives.
- 6.2.3 The Company shall establish and maintain a Code Administrator function, which shall carry out the roles referred to in Paragraphs 4.4.4 and 6.2.4.
- 6.2.4 The Code Administrator will undertake, and the STC Modification Panel shall ensure that the Code Administrator will undertake, its functions consistently with the Code Administrator Code of Practice. The Code Administrator will provide assistance to Parties insofar as practicable, and on reasonable request, in relation to their engagement with the STC Modification process
- 6.2.5 The procedures set out in the Code, to the extent that they are dealt with in the Code Administration Code of Practice, are consistent with the principles contained in the Code Administration Code of Practice. Where inconsistencies or conflicts exist between the Code and the Code Administration Code of Practice, the Code shall take precedence.

6.3 Structure of STC Modification Panel Meetings

- 6.3.1 STC Modification Panel Meetings shall be held on a monthly basis unless otherwise requested by a Party Representative and with the agreement of the other Party Representatives, or as otherwise specifically provided for in this Section B, at such time, at such place in Great Britain and in such form including, without limitation, by way of teleconference as the Party Representatives shall decide.

- 6.3.2 In the event that the Panel Chairperson is not present within fifteen minutes of the scheduled start of any STC Modification Panel Meeting and has not nominated another person to take the position of chairperson pursuant to sub-paragraph 6.4.2, those Party Representatives present shall appoint one of their number to act as Panel Chairperson for that STC Modification Panel Meeting. Subject to paragraph 6.4, the functions of the Panel Chairperson include:
- 6.3.2.1 to ensure that STC Modification Panel Meetings are conducted in a proper, impartial and efficient manner;
 - 6.3.2.2 to ensure that each Party Representative, any person invited to speak pursuant to sub-paragraph 6.5.1, any representatives of any person designated by the Authority under sub-paragraph 6.1.6 and any representative of the Authority have been given a reasonable opportunity to speak on any matter raised in a notice issued to each Party Representative pursuant to sub-paragraph 6.3.5; and
 - 6.3.2.3 to ensure that any relevant matter is put to a vote pursuant to paragraph 6.4 during the STC Modification Panel Meeting.
- 6.3.3 In the event that the Panel Secretary is not present within fifteen minutes of the scheduled start of any STC Modification Panel Meeting, those Party Representatives present shall appoint one of their number to act as Panel Secretary for that STC Modification Panel Meeting.
- 6.3.4 A Party or other person designated under sub-paragraph 7.2.2.1(b) may submit matters (excluding new modifications) and any supporting papers for consideration at a STC Modification Panel Meeting to be received by the Panel Secretary not less than five Business Days before the date of that STC Modification Panel Meeting or such shorter period as the Party Representatives may agree. Where a STC or STCP Modification Proposal is received more than ten (10) Business Days prior to the next STC Panel meeting, the Panel Secretary shall place the STC Modification Proposal on the agenda of the next STC Panel meeting and otherwise shall place it on the agenda of the next succeeding STC Panel meeting.
- 6.3.5 In accordance with this paragraph 6.3, a STC Modification Panel Meeting shall be convened by the Panel Secretary, by notice to each Party Representative:
- 6.3.5.1 setting out the date, time and place of the STC Modification Panel Meeting and (unless the Party Representatives decide otherwise) giving at least ten Business Days' notice before the date of the STC Modification Panel Meeting;
 - 6.3.5.2 accompanied by an agenda of the matters for consideration at the STC Modification Panel Meeting and any supporting papers at the time the notice is given,

and subsequently send to the Party Representatives any supporting papers received not less than five Business Days before the date of the STC Modification Panel Meeting or such shorter period as the Party Representatives may agree.

6.3.6 The Panel Secretary shall send a copy of the notice convening a STC Modification Panel Meeting, and the agenda and papers accompanying the notice to the following persons at the same time as the notice under sub-paragraph 6.3.5 is given to the Party Representatives:

6.3.6.1 the appointed representative(s) of the Authority; and

6.3.6.2 any other person designated by the Authority under sub-paragraph 7.2.2.1(b),

and subsequently send to such persons any supporting papers received not less than five Business Days or on such earlier date as the Party Representatives receive such supporting papers under sub-paragraph 6.3.5.

6.3.7 With the consent of all Party Representatives the requirements of this paragraph 6.3 as to the date of, manner in and notice on which a STC Modification Panel Meeting is convened, may be waived or modified including, without limitation, pursuant to sub-paragraph 6.3.8 (save that the Party Representatives may not exercise this right to waive or detrimentally modify the rights held by Authority representatives or persons designated by the Authority under sub-paragraph 7.2.2.1(b)).

6.3.8 Where:

6.3.8.1 any matter not contained in the agenda for a STC Modification Panel Meeting is put before a STC Modification Panel Meeting; and

6.3.8.2 in the opinion of the Party Representatives it is necessary (in view of the urgency of the matter) that the STC Modification Panel should resolve upon such matter at the STC Modification Panel Meeting,

(subject always to the provisions of paragraph 6.4), the Party Representatives may so resolve upon such matter at the STC Modification Panel Meeting.

6.4 **Proceedings at STC Modification Panel Meetings**

6.4.1 Subject as expressly provided in the Code, the Party Representatives may regulate the conduct of and adjourn and convene STC Modification Panel Meetings as they deem fit.

6.4.2 The Panel Chairperson shall preside as chairperson of every STC Modification Panel Meeting unless the Panel Chairperson is unable to attend in which case such other person shall take the position of chairperson as the Panel Chairperson shall nominate to act in their place.

- 6.4.3 Subject to sub-paragraph 6.4.6, no business shall be transacted at any STC Modification Panel Meeting unless a Quorum (as defined in sub-paragraph 6.4.5) is present.
- 6.4.4 Each (and only each) Party Representative shall be entitled to exercise one vote at a STC Modification Panel Meeting. A matter before the STC Modification Panel must be agreed in accordance with sub-paragraph 6.6 in order to be passed.
- 6.4.5 For the purposes of this paragraph 6, a "**Quorum**" shall be constituted where each Party Category is represented by at least one Party Representative unless
- (a) all of the Party Representatives representing a Party Category notify the Panel Secretary and the other Party Representatives that the matters to be discussed at such STC Modification Panel Meeting do not materially affect the Party Category, in which case such Party Representatives (with the consent of the other Party Representatives) may waive their right to attend and vote, or
 - (b) no Party Representatives have been appointed in accordance with paragraph 6.1.2 by a Party Category.

For the avoidance of doubt, in the circumstances where Party Representatives representing a Party Category have waived their right to attend a meeting matters may only to be voted upon that are contained within the agenda or papers circulated pursuant to paragraph 6.3.5 or 6.3.6.

- 6.4.6 Where a Quorum is not present, the Panel Secretary shall seek to adjourn such STC Modification Panel Meeting to a later date unless it is the third consecutive STC Modification Panel Meeting that has been required to be adjourned as a consequence of the failure to attend by a particular Party Representative, in which case, such STC Modification Panel Meeting shall nonetheless proceed and subsequent ratification of decisions taken at the STC Modification Panel Meeting by such non-attending Party Representative shall not be required unless the lack of attendance by such Party Representative (on any of the three occasions) was as a consequence of an omission to send such Party Representative the details of the STC Modification Panel Meeting required pursuant to sub-paragraph 6.3.5 (unless otherwise agreed pursuant to sub-paragraph 6.3.7), in which case such ratification must be obtained.
- 6.4.7 An omission to send STC Modification Panel Meeting documents to a person entitled to receive them under sub-paragraph 6.3.6.2 shall not prevent a STC Modification Panel Meeting from proceeding unless otherwise directed by the Authority.
- 6.4.8 As soon as is practicable after each STC Modification Panel Meeting, the Panel Secretary shall prepare and send to the Party Representatives and the Authority the minutes of such STC Modification Panel Meeting, which shall be approved (or amended and approved) by the STC Modification Panel at the next STC Modification Panel Meeting after they were so sent and, when approved, the Panel

Secretary shall publish the approved minutes (excluding any matter which it was agreed at such STC Modification Panel Meeting was not appropriate for such publication) on the Code Website.

6.5 Attendance by other persons

6.5.1 A Party Representative may, with the agreement of the other Party Representatives, invite any person other than a person already entitled to attend under paragraph 6.1 to attend all of, or any part of, a STC Modification Panel Meeting and to speak at such STC Modification Panel Meeting or part thereof, where that person so attends. For the avoidance of doubt, a person invited under this paragraph 6.5 shall not have a right to vote at any such STC Modification Panel Meeting or part thereof.

6.6 Agreement of the Party Representatives

6.6.1 Where any provision of this Section B refers to or requires the agreement of the Party Representatives or the Relevant Parties, such agreement must be sought in accordance with the provisions of this paragraph 6.6:

6.6.2 The agreement of the Party Representatives shall be considered to be reached where:

6.6.2.1 There is the unanimous agreement among the Party Representatives, or

6.6.2.2 The number of votes cast in favour of a matter considered in accordance with the Code Voting Procedure is not less than 65%.

6.6.3 Where any provision of this Section B refers to or requires the agreement of the Relevant Party Representatives then such agreement shall be considered to be reached where:

6.6.3.1 There is unanimous agreement amongst the Party Representatives representing the Relevant Party Categories; or,

6.6.3.2 The number of votes cast in favour of a matter considered in accordance with the Code Voting Procedure is not less than 65%.

6.7 Code Voting Procedure

6.7.1 The purpose of this paragraph 6.7 is to make provision for the Party Representatives to vote on behalf of the Parties they are representing as to whether any proposal should be accepted or rejected (the “**Code Voting Procedure**”).

6.7.2 Each proposal shall be put to a vote of the Party Representatives only in accordance with paragraph 6.6.

Groups

- 6.7.3 The Party Representatives for the Offshore Transmission Owner Parties shall have one collective vote to cast.

The Company, NGET, SPT and SHETL shall each have one vote to cast.

With respect to paragraphs 6.7 and 6.8. The Company, NGET, SPT, SHETL shall each be referred to as a 'Group', all Offshore Transmission Owner Party Representatives combined shall be considered as one 'Group'.

- 6.7.4 The STC Modification Panel shall procure the design, establishment and maintenance of a system by which:

6.7.4.1 a report on each proposal to be voted upon is sent to all Party Representatives eligible to vote, specifying the matters to be voted upon, the Party Representatives eligible to vote and the time period within which votes must be cast;

6.7.4.2 each Group within each Party Category that is eligible to vote may cast one (and not more than one) vote on each of the questions comprising each vote;

6.7.4.3 each Group that votes is given the opportunity (but is not obliged) to comment on the reasons for its vote;

6.7.4.4 the vote of each Group is cast by means of a standard form;

6.7.4.5 the vote of each Group is cast in such a way as to permit its authentication as the valid and properly authorised vote of that Group;

6.7.4.6 the vote of each Group may be transmitted in such a manner as (so far as is reasonably practicable) ensures that it is secure and will not be interfered with; and

6.7.4.7 the votes of all of the Groups are received and collated for the purposes of Paragraph 6.8.

- 6.7.5 The STC Modification Panel shall ensure that all Party Representatives are informed of the means by which they may have access to and use the system established under Paragraph 6.7.4 for the purposes of the Code Voting Procedure, and of any changes made to that system from time to time which are likely to affect the way in which it may be accessed and used.

The Vote

- 6.7.6 In respect of each proposal and the report relating to that proposal, the Groups within the Party Categories specified in that report as eligible to vote shall be entitled to cast a vote to accept or to reject each of the questions comprising each vote

- 6.7.7 Each Group which casts a vote on whether to accept or reject the proposal:

6.7.7.1 vote on the basis of its judgment, made by it in good faith, as to whether or not, if the proposal were made, the proposal would better facilitate the achievement of the Applicable STC Objectives than if that proposal were not made; and

6.7.7.2 where it wishes to do so, provide a statement in accordance with the system established under Paragraph 6.7.4 of the reasons, by reference to the Applicable STC Objectives, for its vote.

6.7.8 Where, in respect of a proposal and a Party Category that is specified in the relevant STC Modification Report as being eligible to vote, no Group in that Party Category casts a vote, such Party Category shall, for the purposes of Paragraph 6.8, be treated as if it were not eligible to vote.

6.8 Decision

6.8.1 An STC Modification Proposal shall be accepted where, in respect of each Party Category that was eligible to vote, the number of Groups in that Party Category which voted to accept the proposal is greater than 65% of the total number of Groups in that Party Category which voted

6.8.2 In all other cases an STC Modification Proposal shall be rejected.

6.8.3 The Secretariat shall, as soon as is reasonably practicable after the acceptance or rejection of an STC Modification Proposal, give notice of that decision to:

6.8.3.1 each Party Representative;

6.8.3.2 any person or body that is designated in writing by the Authority for the purpose of paragraph 7.2.2.1 (b); and

6.8.3.3 the Authority,

7. MODIFICATION OF THE CODE AND CODE PROCEDURES

7.1 General

7.1.1 For the purposes of this paragraph 7 only, references to the "Code" shall be deemed not to include reference to the Code Procedures or to Schedule Two.

7.1.2 The process for amending Code Procedures and Schedule Two is set out in paragraph 7.3.

7.1.3 The Code and Code Procedures may (and may only) be amended from time to time pursuant to the Transmission Licence.

7.1.3A Amendments to The Code and Code Procedures may be in response to a Significant Code Review or the Electricity Regulation and/or any relevant **Legally Binding Decisions of the European Commission and/or the Agency**, as provided for in the Transmission Licence.

7.1.3B Change Routes

- (a) A STC Modification Proposal may be a Standard STC Modification Proposal, or it may be subject to additional process steps, if raised during a Significant Code Review, or it may be raised pursuant to paragraph 7.1.10.1 where the Authority reasonably considers that such STC Modification Proposal is necessary to comply with or implement the Electricity Regulation and/or any relevant **Legally Binding Decisions of the European Commission and/or the Agency**.
- (b) If a STC Modification Proposal is deemed by the STC Modification Panel to meet the Self-Governance Criteria, it will be subject to a different process.
- (c) If a STC Fast Track Modification Proposal is determined by the STC Modification Panel to meet the Fast Track Criteria, it will be subject to the process set out at STCP25-3 and shall become a STC Fast Track Report.

7.1.4 An amendment to the Code or to a Code Procedure may necessitate amendment to the contents of a relevant TO Construction Agreement (as opposed to the form of the terms which are set out in a Schedule to the Code and therefore a part of the Code) and, in those circumstances, those agreements contain provisions for such alterations to be effected.

7.1.5 Each Party shall keep under review whether any possible change to this Code or any Code Procedure would better facilitate achievement of the Applicable STC Objectives and shall, in accordance with this paragraph 7 and, to the extent that such matter is not covered by a STC Modification Proposal or a proposed amendment to a Code Procedure, propose such change which, in the Party's opinion, would do so.

7.1.6 The Party Representatives shall endeavour at all times to act pursuant to this Section B, paragraph 7:

7.1.6.1 in an efficient, economical and expeditious manner taking account of the complexity, importance and urgency of a particular amendment; and

7.1.6.2 with a view to ensuring that the Code, Schedule Two and the Code Procedures facilitate achievement of the Applicable STC Objectives.

7.1.7 Significant Code Review

- (a) A Significant Code Review is a code review process initiated and led by the Authority, on one of a number of potential triggers. The Authority will launch a Significant Code Review on publication of a notice setting out matters such as the scope of the review, reasons for it and announcing the start date.

- (b) A Significant Code Review Phase begins on the start date set out in the Authority's notice, during which time STC Modification Proposals that relate to the subject matter of the review are restricted, to ensure the process is as efficient as possible. The Significant Code Review Phase shall end either:
- (i) on the date on which the Authority issues a statement that no directions will be issued or that no modification proposal will be issued in accordance with Paragraph 7.1.7(iii) will be issued in relation to the STC; or
 - (ii) if no statement is made, on the date on which a Party has made a modification proposal in accordance with directions issued by the Authority; or
 - (iii) if no statement is made, on the date that the Authority raises a modification proposal in accordance with Paragraph 7.1.10.1 arising from the relevant Significant Code Review
 - (iv) immediately, if neither a statement, nor directions, nor a modification proposal in accordance with Paragraph 7.1.10.1 are issued by the Authority within (and including) twenty-eight (28) days from the Authority's publication of its Significant Code Review conclusions.
- (c) If the Authority issues a statement that it will continue work on the Significant Code Review and/or issues a direction in accordance with Paragraph 7.1.12 then the Significant Code Review Phase will be deemed to have ended when:
- (i) the Authority issues a statement that the Significant Code Review phase has ended

- (ii) one of the circumstances in Paragraphs 7.1.7(b)(i) or 7.1.7(b)(iii) occurs (irrespective of whether such circumstance occurs within twenty-eight (28) days after the Authority has published its Significant Code Review Conclusions); or
 - (iii) if the Authority makes a decision consenting, or otherwise, to the modification of the STC following the Panel's submission of its report under sub-paragraph 7.1.11.2.
- (d) A process is set out in this Section B and STCP 25-1 for analysing and consulting on STC Modification Proposals with a view to referring to the Authority those that may be restricted during a Significant Code Review. Subject to Paragraph 7.1.8, those STC Modification Proposals that are not so restricted proceed as Standard STC Modification Proposals and requiring consultation with the industry followed by approval or non-approval by the Authority.

7.1.8 Self-Governance

In addition, Self-Governance Criteria are set out against which STC Modification Proposals must also be evaluated and consulted upon. If a proposal meets the criteria, it may proceed without Authority approval, and the STC Modification Panel may consult on and determine itself whether to implement the STC Modification Proposal.

7.1.9 Fast Track

If the STC Modification Panel unanimously determines that a STC Modification Fast Track Report meets the Fast Track Criteria, it will proceed without Authority approval.

7.1.10 Authority Raised or Directed Modification

7.1.10.1 The Authority may:

- (a) itself; or
- (b) direct a Party to raise a STC Modification Proposal that is in respect of a Significant Code Review and/or where the Authority reasonably considers that such STC Modification Proposal is necessary to comply with or implement the Electricity Regulation and/or any relevant **Legally Binding Decisions of the European Commission and/or the Agency**.

7.1.10.2 The Party shall comply with any directions issued by the Authority in relation to setting and/or amending a timetable for;

- (a) the raising of a STC Modification Proposal pursuant to paragraph 7.1.10.1(b); and/or
- (b) where the Authority has approved a STC Modification Proposal raised pursuant to Paragraph 7.1.10.1, implementation of such STC Modification Proposal.

7.1.10.3 In respect of a STC Modification Proposal raised pursuant to paragraph 7.1.10.1, the STC Modification Panel and the Panel Secretary shall each comply with any timetable(s) directed by the Authority in relation to setting and/or amending a timetable for the completion of all relevant steps of the modification process or such other processes set out in this paragraph 7.

7.1.10.4 Notwithstanding any other provision in this paragraph 7, a STC Modification Proposal raised pursuant to Paragraph 7.1.10.1:

- (a) shall not be withdrawn by any Party without the prior consent of the Authority.
- (b) shall not be amalgamated with any other STC Modification Proposal without the prior consent of the Authority.

7.1.10.5 If, pursuant to paragraph 7.1.10.4, the Authority consents to the withdrawal of a STC Modification Proposal, the provisions of paragraph 7.2.2.6 shall apply to such STC Modification Proposal.

7.1.10.6 In respect of any STC Modification Proposal which has been raised by paragraph 7.1.10.1, the views of the relevant Workgroup, the voting rights of the STC Modifications Panel or the recommendation of the Workgroup Report or the STC Modification Report in respect of such STC Modification Proposal shall not be fettered or restricted notwithstanding that such STC Modification Proposal has been so raised under paragraph 7.1.10.1.

7.1.10.7 A STC Modification Proposal shall still be assessed against the Self-Governance Criteria and the Fast Track Criteria notwithstanding that it has been raised pursuant to paragraph 7.1.10.1.

7.1.10.8 In relation to any STC Modification Proposal raised by a Party other than pursuant to Paragraph 7.1.10.1, where the Authority reasonably considers such STC Modification Proposal to be necessary to comply with or implement the Electricity Regulation and/or any relevant **Legally Binding Decisions of the European Commission and/or the Agency**, the provisions of Paragraphs 7.1.10.1 to 7.1.10.7 shall apply.

7.1.11 Authority Led STC Modification

7.1.11.1 Where the Authority has issued a statement in accordance with Paragraph 7.1.7(c) and/or a Backstop Direction in accordance with Paragraph 7.1.12, the Authority may submit an Authority Led STC Modification Proposal for an Authority Led STC Modification directly to the Panel.

7.1.11.2 In response to an Authority Led STC Modification the Panel shall prepare an Authority Led STC Modification Report which shall include:

(a) an evaluation of the proposed modification; and

(b) an assessment of the extent to which the proposed modification would better facilitate achieving the applicable STC objective(s); and

(c) a detailed explanation of the Panel's reasons for that assessment (such assessment to include, where the impact is likely to be material, an assessment of the quantifiable impact of the proposal on greenhouse gas emissions, to be conducted in accordance with any such guidance on the treatment of carbon costs and evaluation of greenhouse gas emissions as may be issued by the Authority from time to time); and

(d) an assessment, to the extent practicable, of the likely impact on each STC Party's Transmission System and any other systems of that STC Party and an

assessment of the likely impact on the National Electricity Transmission System , of the proposed modification;

(e) an assessment of the impact of the modification on the core industry documents and the changes expected to be required to such documents as a consequence of the modification;

(f) a recommendation by the Panel, by reference to the Panel's assessment against the applicable STC objectives, as to whether the proposed modification should be made;

(g) to the extent practicable, the combined views of the STC parties concerning the modification or, where a combined view is not practicable, the views of each STC Party; and

(h) a timetable for implementation of the modification, including the date with effect from which such modification (if made) would take effect.

7.1.11.3 The Authority Led STC Modification Report shall be submitted to the Authority as soon after the Authority Led STC Modification Proposal is submitted for evaluation as is appropriate (taking into account the complexity, importance and urgency of the modification) for the proper execution and completion of the steps in subparagraph 7.1.11.2.

7.1.11.4 The Authority can require the revision and re-submission of the Authority Led STC Modification Report, such resubmission to be made, if required, by a direction issued by the Authority to the Panel in accordance with Paragraph 7.2.5.15, as soon after the Authority's direction as is appropriate (taking into account the complexity, importance and urgency of the modification).

7.1.11.5 The timetable referred to in Paragraph 7.1.11.2(h) for implementation of any modification shall be in accordance with any direction(s) issued by the Authority, or where no such direction has been issued by the Authority, the timetable shall be such as will enable the modification to take effect as soon as practicable after the Authority has directed that such modification should be made, account being taken of the complexity, importance and urgency of the modification with the Authority having discretion to change the timetable after those persons likely to be affected by the revision of the timetable have been consulted.

7.1.11.6 The timetable for the completion of the procedural steps for an Authority Led STC modification, as outlined in Paragraphs 7.1.11.2, 7.1.11.3 and 7.1.11.4 shall be set by the Authority in its sole discretion.

7.1.11.7 The Authority's published conclusions and Authority Led STC Modification Proposal shall not fetter the voting rights of the members of the Panel or the recommendation procedures informing the report described at Paragraph 7.1.11.2.

7.1.12 Backstop Direction

7.1.12.1 Where a STC Modification Proposal has been made in relation to a Significant Code Review in accordance with Paragraph 7.1.10.1 or Paragraph 7.1.11.1 the Authority may issue a direction (a "Backstop Directon"), which requires such proposal(s) and any alternatives to be withdrawn and which causes the Significant Code Review Phase to recommence.

7.2 Amendment of the Code

7.2.1 The remainder of this paragraph 7.2 is subject to the Urgent STC Modification Proposal procedures under sub-paragraph 7.2.6.

7.2.2 STC Modification Proposals

7.2.2.1 A proposal to amend the Code may be made by any of the following:

- (a) a Party; or
- (b) such person or persons having a relevant interest as may be designated in writing for this purpose by the Authority from time to time; or,
- (c) a Party Representative, or,
- (d) The Authority pursuant to 7.1.10.1

(referred to in this Section B as the "**Proposer**").

7.2.2.2 A proposal made pursuant to sub-paragraph 7.2.2.1 shall be submitted in writing to the Panel Secretary and shall contain the following information in relation to such proposal:

- (a) the name of the Proposer;
- (b) a description (in reasonable but not excessive detail) of the issue or defect which the proposal seeks to address;
- (c) a description (in reasonable but not excessive detail) of the proposal and of its nature and purpose;
- (d) where possible, an indication of those parts of the Code and Code Procedures which, in the opinion of the Proposer, would be likely to require amendment in order to give effect to (or would otherwise be affected by) the proposal and an indication of the nature and contents of those amendments or effects (including, where relevant, any need for the establishment of new Code Procedures or removal of existing Code Procedures);

- (e) the reasons why the Proposer believes that the proposal would better facilitate achievement of the Applicable STC Objectives as compared with the then current version of the Code, together with background information in support thereof;
- (f) where possible, an indication of the potential impact of the proposal on the BSC, CUSC or any Core Industry Document and an indication of potential inconsistencies between the proposal and the Capacity Market Documents and/or the CfD Documents;
- (g) the reasoned opinion of the Proposer as to whether the STC Modification Proposal would have a quantifiable effect on greenhouse gas emissions, where the impact is likely to be material, assessed in accordance with such current guidance on the treatment of carbon costs and evaluation of the greenhouse gas emissions as may be issued by the Authority from time to time;
- (h) where possible, an indication of the potential impact of the proposal on relevant computer systems and processes used by the Parties and on any STC Modification Proposal; and
- (i) where a Proposer is a person falling under sub-paragraph 7.2.2.1(b), a statement to the effect that the Proposer acknowledges that, on acceptance of the proposal as a STC Modification Proposal for consideration by the STC Modification Panel (pursuant to sub-paragraph 7.2.2.3) and, notwithstanding that the Proposer is not a Party, the Proposer shall grant a licence and provide a warranty in the same terms as set out in sub-paragraph 7.2.2.5.
- (j) the reasoned opinion of the Proposer as to why the proposed modification should not fall within a current Significant Code Review, whether the proposed modification meets the Self-Governance Criteria or whether the proposed modification should proceed along the Standard STC Modification Proposal route.

Except where the proposal is made to 7.1.10.1, if a proposal fails to contain any information required under this sub-paragraph 7.2.2.2, the Panel Secretary shall notify the Proposer, who may submit a revised proposal in compliance with this sub-paragraph 7.2.2.

Notwithstanding the Proposer failing to provide the information listed in (j) above, the STC Modification Panel may still determine that a STC Modification Proposal meets the Self-Governance Criteria.

7.2.2.3 A proposal made pursuant to paragraph 7.1.10.1 or pursuant to and in compliance with sub-paragraph 7.2.2.2 shall be processed as a “**STC Modification Proposal**” as further provided in this paragraph 7.2.

7.2.2.4 Upon receipt of a STC Modification Proposal, the Panel Secretary shall as soon as reasonably practicable:

- (a) send a copy of the STC Modification Proposal (including the information set out in sub-paragraphs 7.2.2.2(a) to (h)) to the Party Representatives, the Authority and any other person designated by the Authority under sub-paragraph 7.2.2.1(b);
- (b) subject to the provisions of paragraph 6.3 and paragraph 7.1.11, put the STC Modification Proposal on the agenda for the next STC Modification Panel Meeting; and
- (c) post the STC Modification Proposal on the Code Website or, failing that, publish the STC Modification Proposal in such other manner as the Party Representatives deem appropriate to bring it to the attention of interested third parties.

7.2.2.5 It shall be a condition to the right to make a proposal to amend the Code under this paragraph 7.2 that the Proposer:

- (a) grants a non-exclusive royalty-free licence to all Parties who request the same covering all present and future rights, Intellectual Property Rights and moral rights it may have in such proposal (as regards use or application in Great Britain and Offshore); and
- (b) warrants that, to the best of its knowledge, information and belief, no other person has asserted to the Proposer that such person has any Intellectual Property Rights or moral rights or rights of confidence in such proposal inconsistent with the Parties' rights to make, publish or use such proposal,

and, in making a proposal, a Party shall be deemed to have granted the licence and given the warranty contained in sub-paragraphs (a) and (b) above respectively.

7.2.2.6 Save where a STC Modification Proposal has been determined by the STC Modification Panel to fall within a Significant Code Review, or where the STC Modification Proposal has been raised pursuant to paragraph 7.1.10.1, the Proposer may withdraw:

- (a) its STC Modification Proposal on notice to the Panel Secretary at any time;

- (b) its support for a STC Modification Proposal that meets the Self-Governance Criteria by notice to the Panel Secretary at any time prior to the STC Modification Panel Self-Governance Vote undertaken in relation to that STC Modification Proposal pursuant to Paragraph 7.2.6B.10; and
- (c) its support for an STC Modification Fast Track by notice to the Panel Secretary.

in which case, the Panel Secretary shall promptly notify the Party Representatives, the Authority and any other person designated by the Authority under sub-paragraph 7.2.2.1(b) and then, six Business Days after issue of such notice by the Panel Secretary, shall (unless a notice is received pursuant to sub-paragraph 7.2.2.7):

- (a) revise the STC Modification Register;
- (b) remove the STC Modification Proposal from the agenda of the next STC Modification Panel Meeting (as relevant); and
- (c) remove the STC Modification Proposal from the Code Website.

7.2.2.7 Each Party, or any other person designated by the Authority under sub-paragraph 7.2.2.1(b), may within five Business Days of the date of a notice from the Panel Secretary under sub-paragraph 7.2.2.6, notify the Panel Secretary that it is prepared to support the STC Modification Proposal in place of the original Proposer. If such notice is received, the name of such Party or other person designated by the Authority under sub-paragraph 7.2.2.1(b) shall replace that of the original Proposer and such Party or other person shall be treated as the Proposer of the STC Modification Proposal and, subject to the provisions of paragraph 6.3 the STC Modification Proposal shall otherwise continue in accordance with this paragraph 7.2. If more than one notice is received under this sub-paragraph 7.2.2.7, the first received notice shall have effect.

7.2.2.8 Each Party, or any other person designated by the Authority under sub-paragraph 7.2.2.1(b), may propose one or more alternatives to a STC Modification Proposal. Such alternative proposal(s) may be so submitted to the Panel Secretary at any time up until the point at which a STC Modification Proposal is referred to the Assessment and Report Phase under sub-paragraphs 7.2.3.3 or 7.2.4.4 and shall be submitted in the same form as a proposal pursuant to sub-paragraph 7.2.2.2 and, upon compliance with which, such proposal shall be referred to as an "**Alternative STC Modification**". An Alternative STC Modification may

be withdrawn and supported in the same manner as a STC Modification Proposal pursuant to sub-paragraphs 7.2.2.6 and 7.2.2.7. The Proposer of an Alternative STC Modification shall be deemed to be a Proposer for the purposes of this paragraph 7.2.

7.2.3 STC Modification Panel Amendment Meetings

7.2.3.1 Pursuant to sub-paragraph 7.2.2.4, the STC Modification Panel shall consider a STC Modification Proposal or any Alternative STC Modification (unless it or they have been withdrawn under sub-paragraph 7.2.2.6) at the next STC Modification Panel Meeting, in accordance with and subject to the provisions of paragraph 6.3, and at such STC Modification Panel Meeting shall use all reasonable endeavours to decide (as and where relevant) whether:

- (a) the Party Representatives require additional information in order to assess whether the STC Modification Proposal or any Alternative STC Modification would better facilitate achievement of the Applicable STC Objectives;
- (b) pursuant to a recommendation under sub-paragraph 7.2.6.1(a) to recommend to the Authority that the STC Modification Proposal or any Alternative STC Modification should be treated as an Urgent STC Modification Proposal;
- (c) pursuant to sub-paragraph 7.2.3.4, to amalgamate the STC Modification Proposal with any other STC Modification Proposal;
- (d) to recommend whether or not the STC Modification Proposal should fall within a current Significant Code Review (save where there has been an exemption granted by the Authority in respect of the STC Modification Proposal, which the Authority may grant at any time);
- (e) the STC Modification Proposal satisfies the Self-Governance Criteria or not.

7.2.3.1A Notwithstanding paragraph 7.2.3.1 above, during a Significant Code Review Phase the Authority may conclusively determine that a STC Modification Proposal should fall within a current Significant Code Review.

7.2.3.2 Where, pursuant to sub-paragraph 7.2.3.1(a) above, the STC Modification Panel decides that any of the Party Representatives

requires additional information or the STC Modification Panel cannot reach a decision on such matter, the STC Modification Panel shall refer the STC Modification Proposal or any Alternative STC Modification for evaluation under sub-paragraph 7.2.4.

7.2.3.3 Where, pursuant to sub-paragraph 7.2.3.1(a) above, the STC Modification Panel decides that the Party Representatives do not require additional information, the STC Modification Panel shall refer the STC Modification Proposal or any Alternative STC Modification directly to the Assessment and Report Phase under sub-paragraph 7.2.5.

7.2.3.4 Save where the STC Modification Proposal has been raised pursuant to paragraph 7.1.10.1, the STC Modification Panel may decide to amalgamate a STC Modification Proposal with one or more other STC Modification Proposal(s) where the subject matter of STC Modification Proposal is sufficiently proximate to justify amalgamation on the grounds of efficiency and/or where such STC Modification Proposal(s) are logically dependent on each other.

7.2.3.5 Where STC Modification Proposals are amalgamated pursuant to sub-paragraph 7.2.3.4:

- (a) such STC Modification Proposals shall be treated as a single STC Modification Proposal;
- (b) references in this Section B to a STC Modification Proposal shall include and apply to a group of two or more STC Modification Proposals so amalgamated; and
- (c) the Proposers of each such amalgamated STC Modification Proposal shall co-operate in deciding which of them shall constitute the Proposer of such amalgamated STC Modification Proposal, failing which agreement, the STC Modification Proposals shall continue separately as before.

7.2.3.6 Where, pursuant to sub-paragraph 7.2.3.1(d) above, the STC Modification Panel determines that a STC Modification Proposal may fall within the Significant Code Review the process set out in STCP 25-1 shall apply.

7.2.3.7 The STC Modification Panel shall evaluate each STC Modification Proposal against the Self-Governance Criteria. The STC Modification Panel shall follow the procedure set out in Paragraph 7.2.6B in respect of any STC Modification Proposal that the STC Modification Panel considers meets the Self-Governance Criteria unless the Authority makes a direction in accordance with Paragraph 7.2.6B.2 and in such a case that STC Modification Proposal shall be a Standard STC Modification Proposal.

7.2.3.8 Unless the Authority makes a direction in accordance with Paragraph 7.2.6B.4, a STC Modification Proposal that the STC Modification Panel considers does not meet the Self-Governance Criteria shall be a Standard STC Modification Proposal.

7.2.4 Evaluation Phase

7.2.4.1 Subject to paragraph 7.1.10.3, the STC Modification Panel shall use its reasonable endeavours in order to ensure that the Evaluation Phase as set out in this sub-paragraph 7.2.4 shall take no longer than two months (or if a Workgroup is established 4 months) from its referral under sub-paragraph 7.2.3.2 up to the referral to the Assessment and Report Phase under sub-paragraph 7.2.4.4 unless otherwise agreed by the Authority.

7.2.4.2 Following referral of a STC Modification Proposal or any Alternative STC Modification pursuant to sub-paragraph 7.2.3.2, the STC Modification Panel shall invite representations or commission such studies, and other evaluation including through establishing a Workgroup as it deems appropriate in order that each Party Representative is provided with sufficient information such that it can assess whether the STC Modification Proposal or any Alternative STC Modification would better facilitate achievement of the Applicable STC Objectives.

7.2.4.A1 Subject to paragraph 7.1.10.3, where the STC Modification Panel deems it appropriate, it shall establish a Workgroup in accordance with sub-paragraph 7.2.4.2:

7.2.4.A2 A Workgroup shall comprise at least three (3) persons [(who may be STC Modification Panel Members)] agreed by the STC Modification Panel provided there shall always be at least one member representing The Company, and at least two members representing other STC Parties (e.g. Onshore Transmission Owners and/or Offshore Transmission Owners) . Employees of the same company, or of companies that are considered to be an Affiliate of each other, will be considered to be a single workgroup member for the purposes of fulfilling this minimum requirement. A representative of the Authority may attend any meeting of a Workgroup as an observer and may speak at such meeting.

7.2.4.A2.1 A Workgroup in which a category of STC Parties is not represented may at any point be instructed by the Authority to either:

(a) Stop work; or

(b) To provide a report on progress to the next meeting of the STC Modification Panel.

The Authority may also at any point instruct the STC Modification Panel or Code Administrator to seek further representation in such a workgroup.

- 7.2.4.A3 In addition to the quorum in 7.2.4A2, the STC Modification Panel shall appoint the chairperson of the Workgroup who will not be able to vote.
- 7.2.4.A4 The Workgroup shall be assisted by a secretary who shall be appointed by the STC Modification Panel.
- 7.2.4.A5 The STC Modification Panel shall determine the terms of reference of each Workgroup and may change those terms of reference from time to time as it sees fit.
- 7.2.4.A6 The terms of reference for a Workgroup must include provision in respect of the following matters:
 - (a) Detail the Workgroup's responsibilities for assisting the STC Modification Panel in the evaluation of the STC Modification Proposal or any Alternative STC Modification and consider whether it better facilitates achievement of the Applicable STC Objectives and to provide additional information to the STC Modification Panel;
 - (b) Detail the STC Modification Proposal and any Alternative STC Modification;
 - (c) Detail the work to be undertaken by the Workgroup to assist the STC Modification Panel in the evaluation of the STC Modification Proposal or any Alternative STC Modification;
 - (d) Specify any matters which the Workgroup should address in its report;
 - (e) the timetable for the work to be done by the Workgroup;
 - (f) Specify if the Workgroup is to comment upon any legal text.
- 7.2.4.A7 Unless otherwise determined by the STC Modification Panel the Workgroup shall develop and adopt its own internal working procedures for the conduct of its business.
- 7.2.4.A8 A Workgroup Report will be submitted to the STC Modification Panel responding to the matters detailed in the terms of reference and in accordance with the timetable set out in the terms of reference and will indicate the issues and views which arose in the Workgroup discussions and any recommendations made.
- 7.2.4.A9 If a Workgroup is unable to reach agreement on any such matter, the Workgroup Report must reflect the views of the members of the Workgroup.

- 7.2.4.A10 The Workgroup Report will be circulated in draft form to the Workgroup members for a period of not less than five (5) Business days for comment. Any unresolved comments made shall be reflected in the final Workgroup Report.
- 7.2.4.A11 The final Workgroup Report shall be submitted to the Panel Secretary not less than five (5) Business Days prior to the meeting of the STC Modification Panel at which that Workgroup Report is to be discussed.
- 7.2.4.A13 The chairperson or another member (nominated by the chairperson) of the Workgroup shall attend or by way of teleconference the STC Modification Panel Meeting at which that Workgroup Report is to be discussed and may be invited to present the findings and /or answer the questions of STC Modification Panel members. Other members of the Workgroup may also attend such STC Modification Panel meeting.
- 7.2.4.3 Following receipt of any representations, study, Workgroup Report or other evaluation pursuant to sub-paragraph 7.2.4.2, the STC Modification Panel shall consider whether the information provided is sufficient for each Party Representative to form a view as to whether the STC Modification Proposal or any Alternative STC Modification better facilitate achievement of the Applicable STC Objectives and may invite such further representations, studies, and other evaluation including sending matters back to the Workgroup as it deems appropriate until the STC Modification Panel considers that the information provided is sufficient.
- 7.2.4.4. Where a category of STC party (e.g. Onshore Transmission Owners or Offshore Transmission Owners) was not represented within a Workgroup, as appointed under 7.2.4.A2, this shall be noted by the STC Panel and the additional views of such Party Representatives shall be sought.
- 7.2.4.5 Following completion of this Evaluation Phase under this sub-paragraph 7.2.4, the STC Modification Panel shall refer the STC Modification Proposal or any Alternative STC Modification directly to the Assessment and Report Phase under sub-paragraph 7.2.5.

7.2.5 Assessment and Report Phase

- 7.2.5.1 Subject to paragraph 7.1.10.3, the STC Modification Panel together with the Proposer shall use their reasonable endeavours in order to ensure that the Assessment and Report Phase as set out in this sub-paragraph 7.2.5 shall take no longer than six months from its initiation by referral under sub-paragraphs 7.2.3.2 or 7.2.4.4 up to submission of

the STC Modification Report to the Authority under sub-paragraph 7.2.5.11(a) unless otherwise agreed by the Authority.

- 7.2.5.2 Following referral to the Assessment and Report Phase under sub-paragraphs 7.2.3.3 or 7.2.4.4, the STC Modification Panel together with the Proposer shall prepare an analysis and impact assessment (to the extent that such assessment has not already been provided as part of the Evaluation Phase or Workgroup Report) ("**Assessment**"). Such Assessment shall include to the extent reasonably practicable an assessment by the STC Modification Panel and the Proposer of the likely effect of the STC Modification Proposal and any Alternative STC Modification on the National Electricity Transmission System and each Transmission Owner's Transmission System and other systems including a description of any works necessary to implement the change and an estimate of the development, capital and operating costs associated with implementing the changes to the Code and Code Procedures in such manner as the STC Modification Panel feels fit, provided that, so far as any such Assessment requires information which is not generally available concerning the National Electricity Transmission System, such Assessment shall be made on the basis of the STC Modification Panel's and the Proposer's proper assessment (which the STC Modification Panel and the Proposer shall make available for these purposes) of the impact of the STC Modification Proposal or any Alternative STC Modification on the National Electricity Transmission System. Such assessment, shall also include, where the impact is likely to be material, an assessment of the quantifiable impact of the STC Modification Proposal or any Alternative STC Modification on greenhouse gas emissions, to be conducted in accordance with such guidance (on the treatment of carbon costs and evaluation of the greenhouse gas emissions) as may be issued by the Authority from time to time.
- 7.2.5.3 Following completion of the Assessment under sub-paragraph 7.2.5.2 the STC Modification Panel together with the Proposer shall prepare a report and initial recommendation as to whether the STC Modification Proposal and any Alternative STC Modification better facilitate achievement of the Applicable STC Objectives. In so doing, the STC Modification Panel and the Proposer shall use all reasonable endeavours to decide whether the STC Modification Proposal or any Alternative STC Modification would better facilitate achievement of the Applicable STC Objectives and therefore whether or not to recommend to the Authority that a STC Modification Proposal or any Alternative STC Modification should or should not be made.
- 7.2.5.4 Where the STC Modification Panel together with the Proposer cannot reach a decision pursuant to sub-paragraph 7.2.5.3, the STC Modification Panel shall prepare a written statement reflecting the STC Modification Panel's and the Proposer's discussions as to whether the

STC Modification Proposal or any Alternative STC Modification would better meet the Applicable STC Objectives and whether or not each Party Representative and/or the Proposer recommends to the Authority that a STC Modification Proposal or any Alternative STC Modification should or should not be made and such written statement shall be incorporated into the report.

- 7.2.5.5 Where the STC Modification Panel and the Proposer are jointly proposing to recommend to the Authority that a STC Modification Proposal or any Alternative STC Modification should not be made, the STC Modification Panel and the Proposer shall consult with the Authority as to whether the Authority would like the STC Modification Report to include the proposed text to amend the Code. If the Authority does not wish the STC Modification Report to include the proposed text to amend the Code, no text need be included. If the Authority does want the STC Modification Report to include the proposed text to amend the Code and no detailed text has yet been prepared, unless otherwise agreed by the STC Modification Panel or directed by the Authority, the Proposer shall prepare such text to amend the Code and shall seek the views of the STC Modification Panel and take such views into account in preparing such text.
- 7.2.5.6 Where the STC Modification Panel, Proposer or any Party is intending to recommend to the Authority that a STC Modification Proposal or any Alternative STC Modification should be made, such text to amend the Code shall be prepared by the Proposer, unless the STC Modification Panel otherwise agrees that such text should be prepared by another Party or person and the Proposer (or other such person, as appropriate) shall seek the views of the STC Modification Panel and take such views into account in preparing such text.
- 7.2.5.7 Where proposed text to amend the Code has been produced pursuant to sub-paragraphs 7.2.5.5 or 7.2.5.6 (or otherwise) the STC Modification Panel (and any Proposer whose STC Modification Proposal or Alternative STC Modification is the subject of the text) shall decide whether to approve (or amend and then approve) the proposed text, failing which decision, the text shall stand but each Party Representative (and any Proposer of such STC Modification Proposal or Alternative STC Modification that is the subject of the text) shall prepare written representations giving its own opinion on such text.
- 7.2.5.8 Following completion of the steps set out in sub-paragraphs 7.2.5.2 to 7.2.5.7 above (where relevant), the Panel Secretary shall prepare an initial version of the STC Modification Report setting out:
- (a) the STC Modification Proposal and any Alternative STC Modifications; the Workgroup Report and recommendations,

- (b) the recommendation of the STC Modification Panel (or, where the STC Modification Panel and/or the Proposer are not in agreement, the separate statement prepared pursuant to sub-paragraph 7.2.5.4) as to whether or not such STC Modification Proposal or any Alternative STC Modification should be made, including the STC Modification Panel's and Proposer's analysis of whether (and, if so, to what extent) the STC Modification Proposal or any Alternative STC Modification would better facilitate achievement of the Applicable STC Objectives and the views and rationale in respect thereof;
- (c) draft text prepared pursuant to sub-paragraph 7.2.5.7 and any representations on such text where relevant;
- (d) a summary of the STC Modification Panel's and Proposer's Assessment(s) provided pursuant to sub-paragraph 7.2.5.2;
- (e) the proposed Implementation Date of the STC Modification Proposal or any Alternative STC Modifications as agreed by the STC Modification Panel, failing which, as shall be proposed by the Proposer and, in the latter case, accompanied by the written representation of the STC Modification Panel and any Proposer giving their own opinion as to what the Implementation Date should be; and
- (f) (to the extent that such matters are not included pursuant to sub-paragraph (d)), an analysis of:
 - (i) the impact of the STC Modification Proposal and any Alternative STC Modification on the BSC, CUSC and Core Industry Documents, and an indication of potential inconsistencies the STC Modification Proposal and any Alternative STC Modification have with the Capacity Market Documents and CfD Documents, Code Procedures and contents of any Interface Agreement or TO Construction Agreement;
 - (ii) the changes which would be required to give effect to the STC Modification Proposal and any Alternative STC Modification in relation to the BSC, CUSC and Core Industry Documents, Code Procedures and contents of any Interface Agreement or TO Construction Agreement;
 - (iii) the mechanism and likely timescale for making the changes referred to in sub-paragraph (ii);
 - (iv) the changes or developments which would be required to central computer systems and, if practicable, processes used in connection with the operation of

arrangements established under the BSC, CUSC, Core Industry Documents, Capacity Market Documents and CfD Documents;

- (v) the mechanism and likely timescale for making the changes referred to in sub-paragraph (iv);
- (vi) an estimate of the costs associated with making and delivering the changes referred to in sub-paragraphs (ii) and (iv), such costs being expected to relate to: for (ii), the costs of implementing amendments to the BSC, CUSC, Core Industry Document(s) Capacity Market Documents and CfD Documents, Code Procedures, Interface Agreement and TO Construction Agreement, and for (iv), the costs of changes to computer systems and possibly processes which are established for the operation of the BSC, CUSC and Core Industry Documents,

together with a summary of representations of the STC Modification Panel and the Proposer in relation to such matters,

(here referred to as the "**Initial STC Modification Report**") which Initial STC Modification Report shall be approved and amended as appropriate by the STC Modification Panel (save for the contents of those sections where representations are to be provided by each Party Representative in its own capacity as specified above).

7.2.5.9 Pursuant to sub-paragraph 7.2.5.8, the Panel Secretary shall circulate the Initial STC Modification Report to each of the Party Representatives and invite each of the Party Representatives to provide its Assessment, such Assessment to be provided in a consistent manner and including such information as is contained within the STC Modification Panel's Assessment provided in accordance with sub-paragraph 7.2.5.2. Should a Party Representative decide to provide an Assessment in accordance with this sub-paragraph 7.2.5.9 the Party Representative shall provide such assessment in accordance with the timescales specified by the Panel Secretary when circulating the Initial STC Modification Report.

7.2.5.10 Pursuant to sub-paragraph 7.2.5.9, the Panel Secretary shall:

- (a) Incorporate any Assessments provided by Party Representatives pursuant to 7.2.5.9 into the Initial Assessment Report in so doing forming a proposed STC Modification Report (here referred to as the "**Proposed STC Modification Report**")
- (b) circulate the Proposed STC Modification Report to each of the Party Representatives, any persons designated by the

Authority under sub-paragraph 7.2.2.1(b), the CM Administrative Parties and the CfD Administrative Parties and such persons or bodies as have responsibility for progressing changes to the BSC, CUSC and Core Industry Documents and publish it on the Code Website or otherwise in such manner as may be deemed appropriate by the Party Representatives to bring it to the attention of other persons who may have a relevant interest in the STC Modification Proposal or any Alternative STC Modification;

- (c) invite representations in relation to the Proposed STC Modification Report within such period as the STC Modification Panel shall determine (and, in any event, not more than one month); and
- (d) on receipt of representations pursuant to sub-paragraph (b), prepare a summary of such representations.

7.2.5.11 Pursuant to sub-paragraph 7.2.5.10, the STC Modification Panel shall consider the representations made in response to the Proposed STC Modification Report and shall instruct the Panel Secretary to make such changes to the Proposed STC Modification Report as may be agreed by the STC Modification Panel (save for the contents of those sections where representations are to be provided by each Party Representative, the Proposer or other person designated by the Authority under sub-paragraph 7.2.2.1(b) (where appropriate) in its own capacity, as specified above, in which case such Party Representative may, after notifying the STC Modification Panel, direct the Panel Secretary to make reasonable changes to its representations). When the STC Modification Panel considers that any minor changes to the legal text contained in the STC Modification Report are necessary (such as changes of a typographical, grammatical or clarificatory nature) it shall be entitled to instruct the Panel Secretary to make such changes. Where the STC Modification Panel considers a change to the legal text contained in the STC Modification Report to be necessary, but such changes are not minor changes, the STC Modification Panel shall instruct the Panel Secretary to prepare revised legal text incorporating such changes and circulate that revised legal text to, and invite representations from, those persons to whom the Proposed STC Modification Report was circulated pursuant to sub-paragraph 7.2.5.10(b). Representations shall be provided within such period as the STC Modification Panel shall determine and, upon receipt, shall be dealt with in accordance with sub-paragraph 7.2.5.10(d) and this sub-paragraph 7.2.5.11.

7.2.5.12 Following the process referred to in sub-paragraph 7.2.5.11, the Proposed STC Modification Report shall be referred to as the "**STC Modification Report**". The Panel Secretary shall finalise the STC

Modification Report and attach the summary of representations prepared pursuant to sub-paragraph 7.2.5.10(d) (together with the actual representations received), to the STC Modification Report and shall promptly:

- (a) submit such STC Modification Report to the Authority; and
- (b) copy such STC Modification Report to each of the Party Representative, the Proposer, persons designated by the Authority under sub-paragraph 7.2.2.1(b), each owner of the BSC, CUSC and Core Industry Documents, the CM Administrative Parties and the CfD Administrative Parties and post it on the Code Website.

7.2.5.13 Each STC Modification Report shall be addressed and furnished to the Authority and none of the facts, opinions or statements contained in such STC Modification Report may be relied upon by any other person.

7.2.5.14 The Company shall copy any notice received by it from the Authority following submission of the STC Modification Report in relation to the approval (or otherwise) of a STC Modification Proposal or any Alternative STC Modification to each of the Party Representatives and persons designated by the Authority under sub-paragraph 7.2.2.1(b) and the Panel Secretary shall publish such notice on the Code Website.

7.2.5.15 If the Authority determines that the STC Modification Report is such that the Authority cannot properly form an opinion on the STC Modification Proposal and any Alternative STC Modification(s), it may issue a direction to the STC Modification Panel:

- (a) specifying the additional steps (including drafting or amending existing drafting associated with the STC Modification Proposal and any Alternative STC Modification(s)), revision (including revision to the timetable), analysis or information that it requires in order to form such an opinion; and
- (b) requiring the STC Modification Report to be revised and to be re-submitted

and in the event of the Authority making such a direction STCP 25-2 shall apply.

7.2.6 Urgent STC Modification Proposals

7.2.6.1 Any Party or the Proposer (where the Proposer is not a Party) may:

- (a) recommend to the STC Modification Panel that a proposal to amend the Code be treated as an Urgent STC Modification Proposal and provide a suggested timetable in relation to same; or
- (b) request that the Panel Secretary convenes a STC Modification Panel Meeting by such means as are reasonably practicable to obtain the agreement of the STC Modification Panel (or otherwise) that the proposal be treated as an Urgent STC Modification Proposal; or
- (c) where a STC Modification Panel Meeting cannot be arranged pursuant to sub-paragraph (b) above due to lack of agreement on the part of the Party Representatives, itself refer the proposal to the Authority for determination as to whether such proposal may be treated as an Urgent STC Modification Proposal and, if so, as to the procedure and timetable which should apply in respect thereof and, in doing so, shall state that the STC Modification Panel has not considered the matter.

7.2.6.2 If the STC Modification Panel decides that such proposal should be treated as an Urgent STC Modification Proposal pursuant to sub-paragraph 7.2.6.1, the STC Modification Panel shall promptly consult with the Authority as to whether such proposal should be treated as an Urgent STC Modification Proposal and, if so, as to the procedure and timetable which should apply in respect thereof.

7.2.6.3 If the STC Modification Panel is not in agreement pursuant to sub-paragraph 7.2.6.1 that a proposal be treated as an Urgent STC Modification Proposal, any Party may itself refer the matter to the Authority but, in doing so, shall state that the STC Modification Panel do not recommend that the proposal be treated as an Urgent STC Modification Proposal.

7.2.6.4 The STC Modification Panel shall:

- (a) not treat any proposal as an Urgent STC Modification Proposal except with the prior consent of the Authority;
- (b) comply with the procedure and timetable in respect of any Urgent STC Modification Proposal approved by the Authority; and
- (c) comply with any instruction of the Authority issued in respect of such Urgent STC Modification Proposal.

7.2.6.5 For the purposes of this sub-paragraph 7.2.6, the procedure and timetable in respect of an Urgent STC Modification Proposal may (with the approval of the Authority pursuant to sub-paragraphs 7.2.6.2 or

7.2.6.3) deviate from all or part of the STC Modification Procedures (save for this sub-paragraph 7.2.6) or follow any other procedure or timetable approved by the Authority. The STC Modification Panel must notify the CM Administrative Parties and the CfD Administrative Parties of any Urgent STC Modification Proposal and when approving the alternative procedure or timetable, the Authority must consider whether or not such procedure and timetable should allow for the CM Administrative Parties and the CfD Administrative Parties to be consulted on the Urgent STC Modification Proposal and if so how much time should be allowed.

7.2.6.6 Any STC Modification Report (unless the Authority states that this is not required pursuant to sub-paragraphs 7.2.6.2 or 7.2.6.3) in respect of an Urgent STC Modification Proposal (as relevant pursuant to sub-paragraph 7.2.6.5) shall include a statement as to why the STC Modification Panel or the Proposer (as relevant) believes that such proposal should be treated as an Urgent STC Modification Proposal and the extent to which the procedure followed deviated from the other STC Modification Procedures that would apply to a STC Modification Proposal.

7.2.6.7 The STC Modification Panel shall respectively take all reasonable steps to ensure that an Urgent STC Modification Proposal is considered, evaluated and (subject to the approval of the Authority) implemented as soon as reasonably practicable, having regard to the urgency of the matter and, for the avoidance of doubt, an Urgent STC Modification Proposal may (subject to the approval of the Authority) result in an amendment to the Code being made on the day on which such proposal is submitted.

7.2.6A Significant Code Review

7.2.6A.1 The Process set out in the STCP 25-1 shall apply during a Significant Code Review Phase.

7.2.6A.2 The Authority shall publish its Significant Code Review conclusions, and, if within 28 days after such publication the Authority issues to a Party directions, including directions to a Party to make STC Modification Proposals, such Party shall comply with those directions. Where the Party makes a STC Modification Proposal in accordance with the Authority's directions, that STC Modification Proposal shall be treated as a Standard STC Modification Proposal and shall proceed through the process for Standard STC Modification Proposals set out in Paragraph 7. Such Authority conclusions and directions shall not fetter the voting rights of the Panel Members or any recommendation it makes in relation to any STC Modification Proposal or the recommendation procedures informing the STC Modification Report.

7.2.6A.3 Any Party which makes an STC Modification Proposal pursuant to 7.2.6A.2 may not, without the prior consent of the Authority, withdraw such STC Modification Proposal.

7.2.6B Self-Governance

7.2.6B.1 If the STC Modification Panel, having evaluated a STC Modification Proposal against the Self-Governance Criteria, pursuant to Paragraph 7.2.3.7, considers that the STC Modification Proposal meets the Self-Governance Criteria, the Panel Secretary shall:

- (a) document the decision in the minutes of the relevant Panel Meeting;
- (b) within two (2) days of the Panel Meeting, prepare and send to all Parties, and the Authority, a Self-Governance Statement setting out its reasoning in detail and publish the Self-Governance Statement on the Code Website.

7.2.6B.2 The Authority may, at any time prior to the STC Modification Panel's determination made pursuant to Paragraph 7.2.6B.4, give written notice that it disagrees with the Self-Governance Statement and may direct that the STC Modification Proposal proceeds through the process for Standard STC Modification Proposals.

7.2.6B.3 Subject to Paragraph 7.2.6B.2, after publishing a Self-Governance Statement, the STC Modification Panel shall follow the procedure set out in Paragraphs 7.2.4 and 7.2.5.1 to 7.2.5.7.

7.2.6B.4 The Authority may issue a direction to the STC Modification Panel in relation to a STC Modification Proposal to follow the procedure set out for STC Modification Proposals that meet the Self-Governance Criteria, notwithstanding that no Self-Governance Statement has been submitted or a Self-Governance Statement has been retracted and the STC Modification Panel shall follow the procedure set out in Paragraphs 7 save for this Paragraph 7.2.6B.

7.2.6B.5 Subject to completion of the Evaluation Phase pursuant to Paragraph 7.2.4, the STC Modification Panel shall prepare a report (the "STC Modification Self-Governance Report").

7.2.6B.6 The matters to be included in a STC Modification Self-Governance Report shall be the following (in respect of the STC Modification Proposal):

(a) details of its analysis of the STC Modification Proposal against the Self-Governance Criteria;

(b) copies of any/all consultation responses received;

(c) the date on which the STC Modification Panel Self-Governance Vote shall take place, which shall not be earlier than seven (7) days from the date on which the STC Modification Self-Governance Report is furnished to the Authority in accordance with Paragraph 7.2.6B.7; and such other information that is considered relevant by the STC Modification Panel.

(d) a detailed explanation of the reasons for the Panel's assessment of the modification as to whether it would or would not further the relevant STC Objectives.

7.2.6B.7 A draft of the STC Modification Self-Governance Report will be circulated by the Code Administrator to the Party Representatives and the CM Administrative Parties and the CfD Administrative Parties (and its provision in electronic form on the Code Website and in electronic mails to Party Representatives, who must supply relevant details, shall meet this requirement) and a period of no less than five (5) Business Days given for comments to be made thereon. Any unresolved comments made shall be reflected in the final STC Modification Self-Governance Report.

7.2.6B.8 Each STC Modification Self-Governance Report shall be addressed and furnished to the Authority and none of the facts, opinions or statements contained in such STC Modification Self-Governance Report may be relied upon by any other person.

7.2.6B.9 The Code Administrator shall make available on the Code Website and copy (by electronic mail to those persons who have supplied relevant details to the Code Administrator) the STC Modification Self-Governance Report prepared in accordance with Paragraph 7.2.6B to:

- (i) the Party Representatives;
- (ii) each Panel Member; and
- (iii) any person who may request a copy,

and shall place a copy on the Code Website.

7.2.6B.10 If the Authority does not give written notice that its decision is required pursuant to Paragraph 7.2.6B.2, or if the Authority determines that the Self-Governance Criteria are satisfied in accordance with Paragraph 7.2.6B.4, then the STC Modification Self-Governance Report shall be tabled at the Panel Meeting following submission of that STC Modification Self-Governance Report to the Authority at which the Panel Chairperson will undertake the STC Modification Panel Self-Governance Vote based on an assessment against the applicable STC

Objectives and the STC Modification Panel shall give notice of the outcome of such vote to the Panel Secretary.

- 7.2.6B.11 If the STC Modification Panel vote to approve the STC Modification Proposal pursuant to Paragraph 7.2.6B.10 (which shall then be an “Approved STC Modification Proposal” until implemented), then subject to the appeal procedures set out in Paragraphs 7.2.6B.14 to Paragraph 7.2.6B.19 the STC Modification Proposal will be implemented in accordance with Paragraphs 7.2.10.2 to 7.2.10.8 by the Code Administrator without the Authority’s approval and brought to the attention of the Parties and such other persons as may properly be considered to have an appropriate interest in it.
- 7.2.6B.12 The STC Modification Panel may at any time prior to the STC Modification Panel’s determination retract a Self-Governance Statement subject to Paragraph 7.2.6B.10, or if the Authority notifies the STC Modification Panel that it has determined that a STC Modification Proposal does not meet the Self-Governance Criteria the STC Modification Panel shall treat the STC Modification Proposal as a Standard STC Modification Proposal and shall comply with Paragraph 7.2.5, using the STC Modification Self-Governance Report as a basis for its Proposed STC Modification Report.
- 7.2.6B.13 Except where the Authority has issued a direction pursuant to Paragraph 7.2.6B.10, the STC Modification Panel may remove a STC Modification Proposal from the process detailed in this Paragraph 7.2.6B before making its determination pursuant to Paragraph 7.2.6B.4. In that circumstance, the STC Modification Proposal shall be treated as a Standard STC Modification Proposal and shall proceed through the process for Standard STC Modification Proposals.
- 7.2.6B.14 A STC Party or a Materially Affected Party may appeal to the Authority the approval or rejection by the STC Modification Panel of a STC Modification Proposal and any Alternative STC Modification (s) in accordance with Paragraph 7.2.6B.10, provided that the Panel Secretary is also notified, and the appeal has been made up to and including fifteen (15) Business Days after the STC Modification Panel Self-Governance Vote has been undertaken pursuant to Paragraph 7.2.6B.10. If such an appeal is made, implementation of the STC Modification Proposal shall be suspended pending the outcome. The appealing STC Party or Materially Affected Party must notify the Panel Secretary of the appeal when the appeal is made.
- 7.2.6B.15 The Authority shall consider whether the appeal satisfies the following criteria:

- (a) The appealing party is, or is likely to be, unfairly prejudiced by the implementation or non-implementation of that STC Modification Proposal or Alternative STC Modification(s); or
- (b) The appeal is on the grounds that, in the case of implementation, the STC Modification Proposal or Alternative STC Modification(s) may not better facilitate the achievement of at least one of the Applicable STC Objectives; or
- (c) The appeal is on the grounds that, in the case of non-implementation, the STC Modification Proposal or Alternative STC Modification(s) may better facilitate the achievement of at least one of the Applicable STC Objectives; or
- (d) it is not brought for reasons that are trivial, vexatious or have no reasonable prospect of success

and if the Authority considers that the criteria are not satisfied, it shall dismiss the appeal.

7.2.6B.16 Following any appeal to the Authority, a STC Modification Proposal or Alternative STC Modification(s) shall be treated in accordance with any decision and/or direction of the Authority following that appeal.

7.2.6B.17 If the Authority quashes the STC Modification Panel's determination in respect of a STC Modification Proposal or Alternative STC Modification(s) made in accordance with Paragraph 7.2.6B.10 and takes the decision on the relevant STC Modification Proposal and any Alternative STC Modification(s) itself, following an appeal to the Authority, the STC Modification Panel's determination of that STC Modification Proposal and any Alternative STC Modification(s) contained in the relevant STC Modification Self-Governance Report shall be treated as a STC Modification Report submitted to the Authority pursuant to Paragraph 7.2.5.12.

7.2.6B.18 If the Authority quashes the STC Modification Panel's determination in respect of a STC Modification Proposal or Alternative STC Modification(s) made in accordance with paragraph 7.2.6B.10, the Authority may, following an appeal to the Authority, refer the STC Modification Proposal back to the STC Modification Panel for further re-consideration and a further STC Modification Panel Self-Governance Vote.

7.2.6B.19 Following an appeal to the Authority, the Authority may confirm the STC Modification Panel's determination in respect of a STC Modification Proposal or Alternative STC Modification(s) made in accordance with Paragraph 7.2.6B.10.

7.2.6C Fast Track

- 7.2.6C.1 Where a Proposer believes that a modification to the Code which meets the Fast Track Criteria is required, a STC Modification Fast Track Report may be raised. In such case the procedure in STCP 25-3 shall apply.
- 7.2.6C.2 In the event that a STC Modification Fast Track Report is to be implemented pursuant to STCP 25-3, then the processes for implementation in 7.2.10.2 to 7.2.10.8 shall apply as if the STC Modification Fast Track Report were an Approved STC Modification.
- 7.2.6C.3 Up to and including 15 business days from the publication of a STC Modification Fast Track Report approving implementation of a modification pursuant to STCP 25-3, a Party or the Authority may object to the STC Modification Panel's determination by email to the Panel Secretary at STC.Team@nationalgrid.com who shall inform the Parties and the Authority of the objection and that the proposal shall not be implemented.

7.2.7 **STC Modification Register**

- 7.2.7.1 The Panel Committee Secretary shall establish and maintain a register (the "**STC Modification Register**") which shall record, in such form as the STC Modification Panel may determine, the matters set out in subparagraph 7.2.7.3.
- 7.2.7.2 The purpose of the STC Modification Register shall be to assist the STC Modification Panel in the operation of the STC Modification Procedures under this Code and to enable the Parties and other interested third parties (including any person designated by the Authority under subparagraph 7.2.2.1(b)) to be reasonably informed of the progress of STC Modification Proposals including any Alternative STC Modifications, Urgent STC Modification Proposals and Approved STC Modifications from time to time.
- 7.2.7.3 The STC Modification Register shall record:
- (a) details of each STC Modification Proposal and any Alternative STC Modification or Urgent STC Modification Proposal (including the name of the Proposer, the date of the STC Modification Proposal or any Alternative STC Modification or Urgent STC Modification Proposal and a brief description of the STC Modification Proposal or any Alternative STC Modification) or Urgent STC Modification Proposal;
 - (b) the current status and progress of each STC Modification Proposal or any Alternative STC Modification or Urgent STC Modification Proposal and the anticipated date for reporting to the Authority in respect thereof;

- (c) the current status and progress of each Approved STC Modification; and
- (d) such other matters as the STC Modification Panel may consider appropriate from time to time in order to achieve the purposes set out in sub-paragraph 7.2.7.2.

7.2.7.4 The STC Modification Register shall, in addition to those matters set out in sub-paragraphs 7.2.7.3, also include details of:

- (a) each STC Modification Proposal or any Alternative STC Modification which has been withdrawn pursuant to sub-paragraph 7.2.2.6 or rejected by the Authority; and
- (b) each Approved STC Modification which has been implemented pursuant to sub-paragraph 7.2.10,

for a period of six months after such withdrawal, rejection or implementation, or such longer period as the STC Modification Panel may determine.

7.2.7.5 The Panel Secretary shall publish the STC Modification Register (as updated from time to time and indicating the revisions since the previous issue) on the Code Website or (in the absence, for whatever reason, of the Code Website) in such other manner and with such frequency (being not less than once per month) as the STC Modification Panel may agree, in order to bring it to the attention of interested third parties and send a copy of same to each of the Party Representatives and any person designated by the Authority under sub-paragraph 7.2.2.1(b).

7.2.8 **Monthly Progress Report**

7.2.8.1 The STC Modification Panel shall prepare and submit to the Authority each month (or such less frequent period as shall be agreed with the Authority if there is no material matter arising to report) a report (to be known as the "**Progress Report**") setting out the matters referred to in sub-paragraph 7.2.8.2 in respect of the preceding month (or such longer period, as applicable) and the Panel Secretary shall then send a copy of the Progress Report to each Party Representative and persons designated by the Authority under sub-paragraph 7.2.2.1(b).

7.2.8.2 The Progress Report shall contain:

- (a) the current version of the STC Modification Register;
- (b) details of the scheduling and timetable for consideration of each STC Modification Proposal or any Alternative STC Modification or Urgent STC Modification Proposal and completion of the

STC Modification Report in respect thereof in the context of all other current STC Modification Proposals or any Alternative STC Modification or Urgent STC Modification Proposal (including an indication of the priority that the STC Modification Panel affords to and between such proposals);

- (c) details of any decision to amalgamate STC Modification Proposals under sub-paragraph 7.2.3.4;
- (d) details of any circumstances which lead the STC Modification Panel or any Party to believe that the Implementation Date for an Approved STC Modification is unlikely to be met and, if so, why;
- (e) such other matters as the Authority may request to be included from time to time; and
- (f) the basis for each of the decisions referred to above.

7.2.8.3 In the event that the Authority at any time submits a written request to the STC Modification Panel to provide to it any information with respect to consideration or progress of any STC Modification Proposal, Alternative STC Modification or Urgent STC Modification Proposal, the STC Modification Panel shall promptly comply with such request.

7.2.8.4 If, following discussion with the STC Modification Panel, the Authority issues a notice to the Panel Secretary requesting the STC Modification Panel:

- (a) not to amalgamate STC Modification Proposal as set out in the Progress Report; or
- (b) to amend the timetable for a STC Modification Proposal or any Alternative STC Modification or Urgent STC Modification Proposal (including the priority afforded to and between such proposals),

the Panel Secretary shall send a copy of the notice to each Party, Party Representative and any person designated by the Authority under sub-paragraph 7.2.2.1(b)). The STC Modification Panel shall comply with such notice.

7.2.8.5 The Panel Secretary shall publish each Progress Report on the Code Website within seven Business Days after it is sent to the Authority, provided that the Panel Secretary shall exclude therefrom any notice issued by the Authority pursuant to this paragraph 7.

7.2.9 Change Co-ordination

7.2.9.1 The STC Modification Panel shall establish (and, where appropriate, revise from time to time) joint working arrangements with each panel or other body responsible for proposing change to the BSC, CUSC or Core Industry Document, to facilitate the identification, co-ordination, making and implementation of change to the BSC, CUSC, Capacity Market Documents, CfD Documents or Core Industry Document or such other designated documents consequent on an amendment to the Code, and to facilitate the identification of potential inconsistencies that STC Modification Proposals and any Alternative STC Modification have with the Capacity Market Documents and/or CfD Documents in a full and timely manner. Such working arrangements shall include, without limitation, inviting representatives from panels and bodies referred to in this sub-paragraph 7.2.9.1 to participate in any Workgroups established or discussions with the STC Modification Panel or any Party pursuant to this paragraph 7, when the STC Modification Panel or a Party or Parties otherwise identify the likelihood of an impact of a STC Modification Proposal and any Alternative STC Modification, on the BSC, CUSC, Core Industry Document or such other designated document, or identify the likelihood of potential inconsistencies that the STC Modification Proposal and any Alternative STC Modification have with the Capacity Market Documents an/or CfD Documents.

7.2.9.2 The working arrangements referred to in sub-paragraph 7.2.9.1 shall be such as enable the consideration, development and evaluation of STC Modification Proposals and Alternative STC Modifications, and the implementation of Approved STC Modifications, to proceed in a full and timely manner and enable changes to the BSC, CUSC, Capacity Market Documents, CfD Documents or Core Industry Document or other designated documents consequent on an Approved STC Modification to be made and given effect wherever possible (subject to any necessary consent of the Authority) at the same time as such Approved STC Modification is made and given effect.

7.2.10 Implementation

7.2.10.1 Upon service by The Company to the Parties and any person designated by the Authority under sub-paragraph 7.2.2.1(b), of a signed notice of amendment in accordance with a direction of the Authority issued pursuant to The Company's Transmission Licence, the Code shall be amended in accordance with the terms of such notice.

7.2.10.2 An amendment to the Code shall take effect from the date and time as specified in the notice referred to in sub-paragraph 7.2.10.1 or, in the

absence of any such specified time and date, 00:00 hours on the day next following the date of service of such notice.

7.2.10.3 The Parties shall be responsible for implementing any Approved STC Modification in accordance with this sub-paragraph 7.2.10.

7.2.10.4 The Relevant Parties to Code Procedures shall as soon as reasonably practicable make such amendments to Code Procedures or adopt such new Code Procedures as are necessary to give full and timely effect to an Approved STC Modification by the Implementation Date.

7.2.10.5 In relation to Approved STC Modifications:

(a) each Party shall use its reasonable endeavours to progress changes made to the BSC, CUSC and Core Industry Documents (to the extent that it is a party to them) in order to give full and timely effect to an amendment to the Code by the Implementation Date;

(b) each Party shall do what is required to those of its systems and processes which support the operation of the Code as may be necessary in order to give full and timely effect to an amendment to the Code by the Implementation Date; and

(c) each Party must keep the STC Modification Panel informed of any matter that may affect the ability for the Implementation Date to be met.

7.2.10.6 Without prejudice to the obligations of the Parties under this sub-paragraph 7.2.10, the Implementation Date may be extended or shortened with the prior approval of, or at the direction of, the Authority.

7.2.10.7 The STC Modification Panel or any Party shall apply to the Authority for an extension of the Implementation Date if it becomes aware of any circumstances that are likely to cause a delay in the implementation of an Approved STC Modification.

7.2.10.8 An amendment made pursuant to and in accordance with this paragraph 7.2 shall not be impaired or invalidated in any way by any inadvertent failure to comply with or give effect to this sub-paragraph 7.2.10.

7.3 Amendment and Creation of Code Procedures

7.3.1 The Relevant Party Representatives may amend (whether by way of modification, deletion, addition, replacement or otherwise) existing Code Procedures or create additional Code Procedures subject to and in accordance with the procedures set out in this paragraph 7.3.

- 7.3.2 The Relevant Party Representatives may only make amendments to existing Code Procedures or create additional Code Procedures if and to the extent that:
- 7.3.2.1 the amendment or addition falls within the terms and arrangements set out in Standard Condition B12; and
 - 7.3.2.2 the amendment or addition does not impair, frustrate or invalidate the provisions of the Code; and
 - 7.3.2.3 the amendment or addition does not impose new or adjusted obligations or liabilities or restrictions of a material nature on Relevant Parties which cannot be reasonably considered as subsidiary to their existing rights and obligations of the Relevant Parties under the Code; and
 - 7.3.2.4 the amendment or addition is not inconsistent or in conflict with the Code, Transmission Licence Conditions or other relevant statutory requirements; and
 - 7.3.2.5 the Relevant Party Representatives deem that the amendment or addition is appropriate to support compliance with the Code.
- 7.3.3 All Relevant Party Representatives shall use reasonable endeavours to agree between themselves any amendment to an existing Code Procedure or creation of a new Code Procedure that is proposed by a Relevant Party.
- 7.3.4 Where an amendment to an existing Code Procedure, or the creation of a new Code Procedure, is a consequence of a change proposed to the BSC, Grid Code, CUSC, or other Core Industry Document, known as a Cross-Code Change, the Relevant Party Representatives shall use all reasonable endeavours, including joint-working arrangements as appropriate, to develop and agree to changes in a timely manner. The Relevant Party Representatives shall also notify the Panel Secretary if they believe they may need to rely on the procedure set out in 7.3.5.
- 7.3.5 The Relevant Party Representatives may agree to an amendment to an existing Code Procedure or creation of a new Code Procedure under this paragraph 7.3.5 despite the prohibition in sub-paragraph 7.3.2.3 only where:
- 7.3.5.1 The Relevant Party Representatives have provided the STC Modification Panel their written assessment of the anticipated material impact(s);
 - 7.3.5.2 The STC Modification Panel has agreed with the Relevant Party Representatives' materiality assessment, or has provided its own alternative assessment and direction;
 - 7.3.5.3 The Relevant Party Representatives have provided the Authority with such information in writing as it may require in order to inform its decision under sub-paragraph 7.3.5.4

- 7.3.5.4 The Authority has notified the Relevant Party Representatives, and the Panel Secretary, if appropriate, in writing that they may do so, or has provided alternative direction for how Relevant Party Representatives shall proceed. For example the Authority provides ultimate determination of a change.
- 7.3.6 Where the Relevant Party Representatives are unable to reach agreement pursuant to sub-paragraph 7.3.3, any such Relevant Party Representatives may promptly forward the matter as a Dispute to the Authority under Section H, paragraph 4.1 whereupon the Relevant Parties shall comply with such determination and direction as the Authority may make after taking such steps as the Authority may deem fit in order to make such direction (including, without limitation, seeking representations from the Relevant Parties and any other person and consulting on any potential amendment to an existing Code Procedure or creation of a new Code Procedure). The Relevant Parties shall be bound by such direction as the Authority shall make in relation to an amendment to a Code Procedure or creation of a new Code Procedure until such time as the Relevant Party Representatives can agree between themselves any changes pursuant to this paragraph 7.3.
- 7.3.7 For the avoidance of doubt, any direction made by the Authority pursuant to sub-paragraph 7.3.6 shall not constitute approval of any such amendment to a Code Procedure or creation of a new Code Procedure and any notice issued by the Authority pursuant to sub-paragraph 7.3.5 shall only constitute a waiver of such prohibition for the purpose of this Code and shall not constitute approval of the amendment to a Code Procedure or creation of a new Code Procedure in any other respect.
- 7.3.8 Where an amendment to a Code Procedure or the creation of a new Code Procedure is agreed pursuant to sub-paragraph 7.3.3 or directed pursuant to sub-paragraph 7.3.6 then the Relevant Party Representatives shall co-ordinate the sending of the text of the amended Code Procedure or new Code Procedure (and including the proposed effective date for such amendment or new Code Procedure), signed and dated by all Relevant Party Representatives, to the Panel Secretary (for and on behalf of all Relevant Parties).
- 7.3.9 Upon receipt of a signed amended Code Procedure or new Code Procedure pursuant to sub-paragraph 7.3.8, or following direction by the Authority pursuant to 7.3.5.4, the Panel Secretary shall immediately (and in any event prior to the effective date specified by the Relevant Parties in such amended Code Procedure or new Code Procedure):
- 7.3.9.1 send a copy of the amended Code Procedure or new Code Procedure to each of the Relevant Party Representatives and to the Authority;
 - 7.3.9.2 update Schedule Two to include the relevant details of the amended Code Procedure or new Code Procedure;

7.3.9.3 send a notice containing a copy of the amended Schedule Two to the Authority, each of the Party Representatives and to such other person as the Authority may designate from time to time, upon the date of which notice, such amended Schedule shall be deemed to be an amendment to the Code for the purposes of this Section B;

7.3.9.4 post a copy of the amended Schedule Two on the Code Website; and

7.3.9.5 update the library of Code Procedures pursuant to Section A, paragraph 3.

7.3.10 An amendment to a Code Procedure or the addition of a new Code Procedure pursuant to this paragraph 7.3 shall take effect on the date specified in any notice issued pursuant to Section B, sub-paragraph 7.3.9.3.

7.3.11 Unless otherwise directed by the Authority, only the Panel Secretary shall be entitled to amend Schedule Two, and shall only be entitled to do so in accordance with and pursuant to sub-paragraph 7.3.8.

7.4 Publication

7.4.1 Subject to this Section B, any representations submitted by a Party or other person pursuant to the STC Modification Procedures (including, without limitation, any STC Modification Proposal, Alternative STC Modification, Urgent STC Modification Proposal, Assessment or representation or text in relation to any of these) may be made publicly available or disclosed to another Party or Parties or other persons pursuant to this Section B except as expressly requested by such Party or other person by notice in writing to the Panel Secretary (of which notice, the Panel Secretary shall then notify the other Parties and any persons designated under sub-paragraph 7.2.2.1(b)).

7.4.2 The Parties or, for the avoidance of doubt, the Panel Secretary, shall not be liable for any accidental publication of a representation made pursuant to sub-paragraph 7.2.5.

7.4.3 For the avoidance of doubt, all representations made pursuant to this paragraph 7 (whether or not marked confidential) may be sent to the Authority.

7.4.4 In addition to sub-paragraph 7.4.1, where any provision of this Section B provides for data, information or reports to be published or made available to Parties and/or other persons, the STC Modification Panel shall exclude therefrom any matters in respect of which the Authority issues a notice to the Panel Secretary or Parties for the purposes of this paragraph 7.

Annex B1 – Election of Offshore Transmission Owner Party Representatives

B1.1 General

B1.1.1 Introduction

B1.1.1.1 This Annex B1 sets out the basis for election of Offshore Transmission Owner Party Representatives and Offshore Transmission Owner Alternate Representatives for the purpose of Paragraphs 6.1.2 and 6.1A.1.

B1.1.1.2 This Annex B1 shall apply:

(a) in relation to each year (the “Election Year”) in which the term of office of Offshore Transmission Owner Party Representatives and Offshore Transmission Owner Alternate Representatives expires, for the purposes of electing Offshore Transmission Owner Party Representatives and Offshore Transmission Owner Alternate Representatives to hold office with effect from 1st April in that year;

(b) subject to and in accordance with Paragraph B1.4, upon a Offshore Transmission Owner Party Representative and/or Offshore Transmission Owner Alternate Representatives ceasing to hold office before the expiry of their term of office.

B1.1.1.3 For the purposes of an election under Paragraph B1.1.1.2(a) references to Offshore Transmission Owner are to persons who are Offshore Transmission Owner as at 20th December in the previous year.

B1.1.1.4 The Panel Secretary shall administer each election of Offshore Transmission Owner Party Representatives and Offshore Transmission Owner Alternate Representatives pursuant to this Annex B1.

B1.1.1.5 Where the following conditions (a) and (b) in this Paragraph B1.1.1.5 are met, the Offshore Transmission Owner Party Representatives and/or Offshore Transmission Owner Alternate Representatives will be notified to the Panel Secretary as set out below:

(a) each Offshore Transmission Owner Party Representative as at 01 January in the relevant Election Year, has confirmed in writing to the Panel Secretary that the Offshore Transmission Owner Party Representative and/or Offshore Transmission Owner Alternate Representatives will be elected in accordance with a process other than that set out in Annex B (“Alternative OFTO Election Process”); and

(b) each Offshore Transmission Owner Party Representative as at 01 January in the relevant Election Year, has notified the Panel Secretary in writing by 25 January of the relevant Election Year of the identity of the Offshore Transmission Owner Party Representatives and/or Offshore Transmission Owner Alternate Representatives elected through the Alternative OFTO Election Process, and each notification identifies the same individual(s)

Upon receipt of such notifications in accordance with the above, the provisions of this Annex B, with exception of Paragraph B1.1.1.4, shall not apply until the following Election Year.

B1.1.2 Election timetable

B1.1.2.1 The Panel Secretary shall not later than 7th January in the Election Year prepare and circulate to all Offshore Transmission Owners (by publication on the Code Website and, where relevant details are supplied, by electronic mail), with a copy to the Authority, an invitation to nominate candidates who must be willing to be either a Offshore Transmission Owner Party Representative or an Alternate Representative and a timetable for the election (the “Election Timetable”), setting out:

- (a) the date by which nominations of candidates are to be received, which shall not be less than three (3) weeks after the timetable is circulated;
- (b) the date by which the Panel Secretary shall circulate a list of candidates and voting papers;
- (c) the date by which voting papers are to be submitted, which shall not be less than three (3) weeks after the date for circulating voting papers;
- (d) the date by which the results of the election will be made known, which shall not be later than 15th March in the Election Year.

B1.1.2.2 If for any reason it is not practicable to establish an election timetable in accordance with Paragraph B1.2.1.1 or to proceed on the basis of an election timetable which has been established, the Panel Secretary may establish a different timetable, or revise the election timetable, by notice to all Parties, the STC Modification Panel and the Authority, provided that such timetable or revised timetable shall provide for the election to be completed before 1st April in the Election Year.

B1.1.2.3 A nomination or voting paper received by the Panel Secretary later than the respective required date under the election timetable (subject to any revision under Paragraph B1.1.2.2) shall be disregarded in the election.

B1.2. CANDIDATES

B1.2.1 Nominations

B1.2.1.1 Nominations for candidates shall be made in accordance with the Election Timetable.

B1.2.1.2 Subject to Paragraph B1.1.1.3, each Offshore Transmission Owner may nominate one candidate for election by giving notice to the Panel Secretary.

B1.2.2 List of candidates

B1.2.2.1 The Panel Secretary shall draw up a list of the nominated candidates and circulate the list to all Offshore Transmission Owners by the date specified in the Election Timetable.

B1.2.2.2 The list shall specify the Offshore Transmission Owner by whom each candidate was nominated and any affiliations which the candidate may wish to have drawn to the attention of Offshore Transmission Owners.

B1.2.2.3 Except where Paragraphs B1.4.3 or B1.4.4 apply, if two (2) or fewer candidates are nominated no further steps in the election shall take place and such candidate(s) shall be treated as elected as Offshore Transmission Owner Party Representatives and Paragraph B1.3.2.4 shall apply in relation to such candidate(s).

B1.2.2.4 Where Paragraph B1.4.3 applies, if only one (1) candidate is nominated, no further steps in the election shall take place and such candidate shall be treated as elected as a Party Representative and Paragraph B1.3.2.4 shall apply in relation to such candidate.

B1.2.2.5 Where Paragraph B1.4.4 applies, if two (2) or fewer candidates are nominated, no further steps in the election shall take place and such candidate(s) shall be treated as elected as Alternate Representatives and Paragraph B1.3.2.4 shall apply in relation to such candidate(s).

B1.3 VOTING

B1.3.1 Voting papers

B1.3.1.1 Voting papers shall be submitted in accordance with the election timetable.

B1.3.1.2 Each Offshore Transmission Owner may submit one voting paper.

B1.3.2 Preference votes and voting rounds

B1.3.2.1 Each Offshore Transmission Owner submitting a voting paper shall vote by indicating on the voting paper a first, second and third preference ("Preference Votes") among the candidates.

B1.3.2.2 A voting paper need not indicate a second, or a third, preference, but the same candidate may not receive more than one Preference Vote in a voting paper.

B1.3.2.3 Candidates shall be elected in three voting rounds (together where necessary with a further round under Paragraph B1.3.6) in accordance with the further provisions of this Paragraph B1.3.

B1.3.2.4 The Panel Secretary shall determine which candidates are elected and announce (to the Authority and all Offshore Transmission Owners) the results of the election in accordance with the election timetable.

B1.3.2.5 The Panel Secretary shall not disclose the Preference Votes cast by Offshore Transmission Owners or received by candidates; but a Offshore Transmission Owner may by notice to the Authority require that the Authority scrutinise the conduct of the election, provided that such Offshore Transmission Owner shall bear the costs incurred by the Authority in doing so unless the Authority recommends that the election results should be annulled.

B1.3.2.6 Further references to voting papers in this Paragraph B1.3 do not include voting papers which are invalid or are to be disregarded (i.e. voting papers not made or submitted in accordance with the STC).

B1.3.3 First voting round

B1.3.3.1 In the first voting round:

(a) the number of first Preference Votes allocated under all voting papers to each candidate shall be determined.

(b) the first round qualifying total shall be:

$$(T / N) + 1$$

Where

T is the total number of first Preference Votes in all voting papers;

N is the number of Offshore Transmission Owners' Party Representatives and/or Alternate Representatives to be elected.

B1.3.3.2 If the number of first Preference Votes allocated to any candidate is equal to or greater than the first round qualifying total, that candidate shall be elected.

B1.3.4 **Second voting round**

B1.3.4.1 In the second voting round:

- (a) the remaining candidates are those which were not elected in the first voting round;
- (b) the remaining voting papers are voting papers other than those under which the first Preference Votes were for candidates elected in the first voting round;
- (c) the number of first and second Preference Votes allocated under all remaining voting papers to each remaining candidate shall be determined;
- (d) the second round qualifying total shall be

$$(T' / N') + 1$$

where T' is the total number of first Preference Votes and second Preference Votes allocated under all remaining voting papers; N' is the number of Party Representatives and/or Alternate Representatives remaining to be elected after the first voting round.

B1.3.4.2 If the number of first and second Preference Votes allocated to any remaining candidate is equal to or greater than the second round qualifying total, that candidate shall be elected.

B1.3.5 **Third voting round**

B1.3.5.1 In the third voting round:

- (a) the remaining candidates are those which were not elected in the first or second voting rounds;
- (b) the remaining voting papers are voting papers other than those under which the first or second Preference Votes were for candidates elected in the first or second voting rounds;

(c) the number of first, second and third Preference Votes allocated under all remaining voting papers to each remaining candidate shall be determined;

(d) the third round qualifying total shall be

$$(T'' / N'') + 1$$

where T'' is the total number of first Preference Votes, second Preference Votes and third Preference Votes allocated under all remaining voting papers;

N'' is the number of Party Representatives remaining to be elected after the first and second voting rounds.

B1.3.5.2 If the number of first, second and third Preference Votes allocated to any remaining candidate is equal to or greater than the third round qualifying total, that candidate shall be elected.

B1.3.6 Further provisions

B1.3.6.1 If after any voting round the number of candidates achieving the required Preference Votes threshold exceeds the number of persons remaining to be elected, the following tie-break provisions shall apply between the tied candidates. In addition, if after the third voting round any Party Representative(s) or Alternate Representative(s) remain to be elected the following tie-break provisions shall apply between the remaining candidates:

(a) the tied or remaining candidates (as applicable) shall be ranked in order of the number of first Preference Votes allocated to them, and the candidate(s) with the greatest number of such votes shall be elected;

(b) in the event of a tie between two or more candidates within Paragraph (a), the candidate(s) (among those tied) with the greatest number of second Preference Votes shall be elected;

(c) in the event of a tie between two or more candidates within Paragraph (b), the Panel Secretary shall select the candidate(s) (among those tied) to be elected by drawing lots.

B1.3.7 Alternate Representatives and Party Representatives

B1.3.7.1 Except where Paragraphs B1.4.3 or B1.4.4 apply, the two (2) candidates receiving the greatest number of votes shall be elected as Offshore Transmission Owners' Party Representatives and the

next two (2) shall be elected as Offshore Transmission Owners' Alternate Representatives.

B1.3.7.2 Where Paragraph B1.4.3 applies the number of candidate(s) up to and including the number of Party Representative Interim Vacancies receiving the greatest number of votes pursuant to the Interim STC Modification Panel and Alternate Election Process shall be elected as Offshore Transmission Owners' Party Representative(s) and the remaining candidates up to and including the number of Alternate Representative Interim Vacancies receiving the greatest number of votes shall be elected as Alternate Representative(s).

B1.3.7.3 Where Paragraph B1.4.4 applies the two (2) candidates receiving the greatest number of votes pursuant to the Alternate Election Process shall be elected as Alternate Representatives.

B1.4 VACANCIES

B1.4.1 General

B1.4.1.1 If a Party Representative ceases to hold office pursuant to Paragraph 6.1C.1 (b) (i) then Paragraph B1.4.2 shall apply.

B1.4.1.2 If a Party Representative ceases to hold office pursuant to Paragraph 6.1C.1 (a), 6.1C.1 (b) (ii) to (vi) (inclusive) or 6.1C.1 (c) to (e) (inclusive) then Paragraph B1.4.3 shall apply.

B1.4.1.3 If an Alternate Representative ceases to hold office pursuant to Paragraph 6.1C (the "Resigning" Alternate Representative) then Paragraph B1.4.4 shall apply.

B1.4.1.4 The provisions of Paragraph B1.2.1.2 shall apply, mutatis mutandis, to any replacement Party Representative or any replacement Alternate Representative under this Paragraph B1.4.

B1.4.2 Replacement of a Party Representative who ceases to hold office pursuant to Paragraph 6.1C.1 (b) (i)

B1.4.2.1 Where this Paragraph B1.4.2 applies, and in accordance with the duties set out in Paragraph 6.2, such Party Representative may appoint a replacement Party Representative (subject to Paragraph B1.4.2.2) for the remainder of the term of office of such Party Representative and shall notify the Panel Secretary of a replacement Party Representative at the same time as they resign. If such Party Representative does not appoint a replacement at the time of notifying the Panel Secretary of their resignation then such

Party Representative will be replaced in accordance with Paragraph B1.4.3 and this Paragraph B1.4.2.1 shall no longer apply.

B1.4.2.2 A Party Representative shall only appoint an Alternate Representative to be their replacement pursuant to Paragraph B1.4.2.1 and such Alternate Representative chosen to be a Party Representative shall then become a Resigning Alternate Representative and be replaced in accordance with Paragraph B1.4.4.

B1.4.3 Replacement of a Party Representative who ceases to hold office pursuant to Paragraph 6.1C.1 (a), 6.1C.1 (b) (ii) to (vi) (inclusive) or 6.1C.1 (c)

B1.4.3.1 Subject to Paragraph B1.4.3.2, such Party Representative shall, where one or more Alternate Representative(s) hold office, be replaced by the Alternate Representative who previously received the highest number of cumulative Preference Votes but if there were a tie-break in relation to such Preference Votes then the tie-break provisions set out in Paragraph B1.3.6.1 shall apply, in either circumstance such Alternate Representative selected to be a Party Representative shall then become a Resigning Alternate Representative and be replaced in accordance with Paragraph B1.4.4.

B1.4.3.2 If there are no Alternate Representatives in office upon a Party Representative ceasing to hold office then:

(a) Where there are not less than six (6) months remaining until the next full election further Party Representatives shall be elected in accordance with Paragraphs B1.2, B1.3 and subject to the following Paragraphs B1.4.3.3 to B1.4.3.5 (inclusive) (the "Interim STC Modification Panel and Alternate Election Process").

(b) Where there are less than six (6) months remaining until the next full election no further Party Representatives or Alternate Representatives shall be elected pursuant to this Paragraph B1.4.3 and the positions shall remain vacant until the next full election.

B1.4.3.3 Where this Paragraph B1.4.3.3 applies the Panel Secretary shall indicate in the invitation referred to at Paragraph B1.1.2.1 the number of vacancies for both Party Representative(s) ("Party Representative Interim Vacancies") and Alternate Representative(s) ("Alternate Representative Interim Vacancies")

for which the Interim STC Modification Panel and Alternate Election Process is being held.

B1.4.3.4 Any Party Representative(s) or Alternate Representative(s) elected pursuant to the Interim STC Modification Panel and Alternate Election Process shall cease to hold office at the next full election.

B1.4.3.5 The timetable for the Interim STC Modification Panel and Alternate Election Process shall be expedited and the Panel Secretary shall prepare a timetable accordingly.

B1.4.4 Replacement of a Resigning Alternate Representative

B1.4.4.1 Subject to Paragraph B1.4.4.2 a Resigning Alternate Representative shall not be replaced.

B1.4.4.2 If there are no Alternate Representatives remaining in office following the resignation of an Alternate Representative or their appointment as Party Representative in accordance with B1.4.2 or B1.4.3 then

(a) Where there are not less than six (6) months remaining until the next full election further Alternate Representatives shall be elected in accordance with Paragraphs B1.2, B1.3 and subject to the following paragraphs B1.4.4.3 to B1.4.4.5 (inclusive) (the "Alternate Election Process").

(b) Where there are less than six (6) months remaining until the next full election no further Alternate Representatives shall be elected and the positions shall remain vacant until the next full election.

B1.4.4.3 Where this paragraph B1.4.4.3 applies, a reference in Paragraphs B1.2 and B1.3 to an Offshore Transmission Owners' Party Representative or Party Representative shall not apply except in the case of Paragraph B1.3.5.1 (d) where the reference to "Party Representatives" shall be read and construed as a reference to "Alternate Representatives".

B1.4.4.4 Any Alternate Representative(s) elected pursuant to the Alternate Election Process shall cease to hold office at the next full election.

B1.4.4.5 The timetable for the Alternate Election Process shall be expedited and the Panel Secretary shall prepare a timetable accordingly.

SECTION C: TRANSMISSION SERVICES AND OPERATIONS

PART ONE: PROVISION OF TRANSMISSION SERVICES

1. INTRODUCTION

1.1 This Section C, Part One deals with the provision of Transmission Services by Transmission Owners to The Company and the obligations of The Company in relation to its operation of the National Electricity Transmission System, and sets out:

1.1.1 the process for each Transmission Owner to specify the technical limits that normally apply to its Transmission Services in a Services Capability Specification;

1.1.2 the process for developing and implementing Services Restoration Proposals to restore Transmission Services in the event of any unplanned reduction in the technical limits actually applicable to the provision of Transmission Services from time to time; and

1.1.3 provisions dealing with the co-ordination and direction by The Company of the flow of electricity onto and over the National Electricity Transmission System in accordance with technical limits and Licence Standards.

2. TRANSMISSION SERVICES

2.1 In accordance with the provisions of this Code, each Transmission Owner shall provide services to The Company consisting of:

2.1.1 making available those parts of its Transmission System which are intended for the purposes of conveying, or affecting the flow of, electricity, so that such parts are capable of doing so and are fit for those purposes;

2.1.2 a means of enabling The Company to direct the configuration of those parts of that Transmission Owner's Transmission System made available to it and, consistent with such means, giving effect to any such direction from time to time; and

2.1.3 a means of enabling The Company to obtain information in relation to that Transmission Owner's Transmission System which information is needed by The Company to enable it to co-ordinate and direct the flow of electricity onto and over the National Electricity Transmission System and, consistent with such means, providing such information to The Company,

(together here referred to as "**Transmission Services**").

2.2. Each Transmission Owner agrees with The Company to provide Transmission Services and to plan, develop, operate and maintain its Transmission System in accordance with

its Transmission Licence and this Code, subject to any Transmission Derogations from time to time. In the case of Construction Projects that involved OTSDUW, it is acknowledged that a User may have undertaken some or all of the original planning and/or development of the Transmission System.

- 2.3 The Company shall have the right to make use of the Transmission Services provided to it under this Code in pursuance of its activities and the discharge of its obligations under its System Operator Licence and the Act and only in pursuance of such activities or discharge of such obligations.

3. SERVICES CAPABILITY SPECIFICATION

- 3.1 Each Transmission Owner shall separately have and maintain, at all times, a specification of its Transmission Services (here referred to as "**Services Capability Specification**") and shall:

3.1.1 maintain its Services Capability Specification (in accordance with Section D, Part One, sub-paragraph 2.10.2) by including, without limitation, information describing the parameters and levels within and to which its Transmission Services have been planned to be provided, or such higher levels up to which its Transmission Services are normally capable of being so provided, to The Company: such information to include and identify the technical limits that would normally apply to the provision of its Transmission Services (such technical limits as identified in the Service Capability Specification here referred to as the "**Normal Capability Limits**" applicable to those Transmission Services); and

3.1.2 submit a copy of its Services Capability Specification to The Company and immediately submit to The Company copies of any amendments made to it under paragraphs 3.2 or 3.3.

- 3.2 Each Transmission Owner shall keep its Services Capability Specification under review at all times and may amend the content of its Services Capability Specification, including amendments to any Normal Capability Limits:

3.2.1 in the case of the correction of typographical errors only, at any time by submitting copies of such amendments to The Company; and

3.2.2 in all other cases, pursuant to Section D, Part One, sub-paragraph 2.10.2.

- 3.3 Changes to the form of a Transmission Owner's Services Capability Specification may be proposed:

3.3.1 In the case of an Onshore Transmission Owner's Services Capability Specification:

3.3.1.1 by the Transmission Owner at any time, any such change to be agreed between the Transmission Owner and The Company (any failure to agree

shall be referable to the Authority as a Dispute in accordance with Section H, paragraph 4.1); or

3.3.1.2 by The Company at any time, any such change to be agreed between the Transmission Owner and The Company. Any failure to agree shall be referable to the Authority as a Dispute in accordance with Section H, paragraph 4.1.

3.3.2 In the case of an Offshore Transmission Owner's Services Capability Specification, changes to its form may be proposed by the Transmission Owner or The Company using the agreed procedures for the management of Offshore Transmission Owners' Services Capability Specifications.

3.4 In addition to the obligation to submit a copy of its Services Capability Specification and copies of any amendments to The Company under this paragraph 3, a Transmission Owner shall provide to The Company such other information as may reasonably be requested by The Company from time to time in order to support the full and effective enjoyment of the rights of The Company pursuant to paragraph 2. Any dispute as to the reasonableness of such request shall be referable to the Authority as a Dispute in accordance with Section H, paragraph 4.1.

4. TRANSMISSION SERVICES LIMITS

4.1 Each Transmission Owner shall provide Transmission Services to The Company, pursuant to paragraph 2, in accordance with its Services Capability Specification (including to any Normal Capability Limits) except, and only to the extent that:

4.1.1 the provision of such Transmission Services is reduced due to an Outage in accordance with Section C, Part Two;

4.1.2 its Transmission Services are not, other than by reason of an Outage, physically capable of being provided or are not capable, for immediate safety reasons or pursuant to environmental obligations, of being provided in accordance with the Services Capability Specification (referred to as a "**Services Reduction**"); or

4.1.3 the Transmission Owner has notified The Company of technical limits applying in excess of Normal Capability Limits pursuant to paragraph 4.14.

4.2 Each Transmission Owner shall at all times act in accordance with Good Industry Practice in providing Transmission Services to The Company.

4.3 The technical limits to which The Company has been notified that Transmission Services are actually capable of being provided from time to time (being the Normal Capability Limits or such other technical limits as apply due to an Outage, a Services Reduction or any higher limits notified under paragraph 4.14) shall be referred to as the "**Operational Capability Limits**" applicable to those Transmission Services.

4.4 A Transmission Owner shall notify The Company immediately in the event that it becomes aware at any time that the relevant Operational Capability Limits have been

exceeded by The Company in accordance with the agreed procedures for the operation of that Transmission Owner's Transmission System..

- 4.5 Each Transmission Owner shall monitor, in accordance with the agreed procedures for the operation of that Transmission Owner's Transmission System and Good Industry Practice, the provision of its Transmission Services and notify The Company (except in such circumstances as may from time to time be agreed between the Transmission Owner and The Company), as a matter of urgency, as soon as such Transmission Owner becomes aware:
- 4.5.1 of a Services Reduction (including notifying The Company of the revised technical limits that apply to such Transmission Services due to the Services Reduction); or
 - 4.5.2 of a risk, materially beyond the normal level of risk, of an imminent Services Reduction (here referred to as a "**Services Reduction Risk**").
- 4.5A As a part of, or otherwise at the same time as, notice to The Company under paragraph 4.5, an Offshore Transmission Owner shall provide The Company with all of the necessary information required in order to fulfil its reporting obligations under Retained EU Law (Commission Regulation (EU) No 543/2013) within the required timescales (i.e. as soon as possible but no later than one hour after the change in actual availability) in accordance with STCP 02-1 (Alarm & Event Management).
- 4.6 As a part of, or otherwise at the same time as, notice to The Company under paragraph 4.5, unless it is not reasonably practicable to do so (in which case a Transmission Owner shall do so as soon as reasonably practicable thereafter), a Transmission Owner shall notify The Company of:
- 4.6.1 in the case of a Services Reduction Risk, and where so requested by The Company, relevant data or information for the relevant Transmission Services including the technical limits that would apply as a consequence of the relevant Services Reduction if it were to occur;
 - 4.6.2 the reasons for any Services Reduction (or, where relevant, a Services Reduction Risk) including, without limitation, information in relation to any Event which caused or contributed to, or which may cause or contribute to, the Services Reduction or Services Reduction Risk;
 - 4.6.3 additional relevant information including the likely duration of any Services Reduction (or, where relevant, Services Reduction Risk); and
 - 4.6.4 unless otherwise agreed with The Company, such Transmission Owner's proposal, in reasonable but not excessive detail, (referred to here as a "**Services Restoration Proposal**") for, as appropriate:
 - 4.6.4.1 any interim works or other actions which are able to be undertaken by such Transmission Owner to minimise the effect of the Services Reduction or Services Reduction Risk and including, where relevant, any

revised Operational Capability Limits that would apply during the period of such Services Reduction or Services Reduction Risk;

4.6.4.2 restoring the Transmission Services such that they are provided in accordance with their Services Capability Specification (and to their Normal Capability Limits); and

4.6.4.3 otherwise removing, mitigating or dealing with a Services Reduction Risk,

including, in the case of sub-paragraphs 4.6.4.2 and 4.6.4.3, where necessary and appropriate, by proposing to amend the content of its Services Capability Specification (including any Normal Capability Limits) pursuant to Section D, Part One, paragraph 2.10.2.

- 4.7 Nothing in sub-paragraph 4.6.4 shall prevent the Parties from agreeing in advance Services Restoration Proposals to apply generally to particular types of Services Reductions or Services Reduction Risks. If such a Services Restoration Proposal is proposed in advance by a Party, any failure to agree shall be referable to the Authority as a Dispute in accordance with Section H, paragraph 4.1.
- 4.8 On or as soon as reasonably practicable after notification by the Transmission Owner of a Services Reduction (or, where relevant, a Services Reduction Risk) pursuant to paragraph 4.5, The Company and the relevant Transmission Owner shall discuss the Services Reduction (or, where relevant, Services Reduction Risk) and, in particular, agree any Services Restoration Proposal(s) notified under sub-paragraph 4.6.4 or agree that any Services Restoration Proposal(s) agreed in advance under paragraph 4.7 apply. Any failure to agree shall be referable to the Authority as a Dispute in accordance with Section H, paragraph 4.1.
- 4.9 A Party which has agreed a Services Restoration Proposal pursuant to paragraph 4.8 may at any time notify (either verbally or in writing) each other Party involved in such Services Restoration Proposal of any modification which it considers is required to be made to such Services Restoration Proposal in order to deal more appropriately with the Services Reduction or Services Reduction Risk. The Company and the relevant Transmission Owner shall discuss and agree any such modification. Any failure to agree a proposed modification shall be referable to the Authority as a Dispute in accordance with Section H, paragraph 4.1.
- 4.10 A Transmission Owner shall give effect to any Services Restoration Proposal agreed with The Company pursuant to paragraph 4.8 (as modified from time to time pursuant to paragraph 4.9).
- 4.11 If the Parties are unable to reach agreement on any Services Restoration Proposal or any proposed modification to such Services Restoration Proposal, a Transmission Owner shall nevertheless give effect to its Services Restoration Proposal (including any modification which such Transmission Owner, in its discretion, considers is required), subject to any subsequent determination of a relevant Dispute referred to the Authority pursuant to paragraphs 4.7, 4.8 or 4.9.

- 4.12 Each Transmission Owner shall take reasonable and appropriate preparatory steps, including, without limitation, having appropriate replacement Plant and Apparatus available, to minimise the duration or effect of Services Reductions and Services Reduction Risks and shall:
- 4.12.1 notify The Company of such steps from time to time or when otherwise reasonably requested by The Company; and
- 4.12.2 comply with any reasonable request from The Company to take or modify preparatory steps as specified in such request.
- 4.13 Any dispute in relation to the adequacy of the preparatory steps taken by a Transmission Owner pursuant to paragraph 4.12 or the reasonableness of a request by The Company shall be referable to the Authority as a Dispute in accordance with Section H, paragraph 4.1 (in the event of a dispute under this paragraph 4.13, a Transmission Owner may take such preparatory steps as it considers, in its discretion, are reasonable and appropriate, subject to the subsequent determination of any Dispute referred to the Authority pursuant to this paragraph 4.13).
- 4.14 For the avoidance of doubt, nothing in the Code shall prevent a Transmission Owner, in its discretion, from notifying The Company (including, without limitation, in response to a request from The Company) that technical limits temporarily apply in respect of specified Transmission Services in excess of their Normal Capability Limits. In any such event the Transmission Owner shall at the same time also notify The Company of any conditions that apply to the use of such Transmission Services at technical limits above their Normal Capability Limits.

5. CONFIGURATION ON THE COMPANY'S DIRECTIONS

- 5.1 A Transmission Owner may only configure such parts of its Transmission System as are made available pursuant to sub-paragraph 2.1.1 of this Section C, Part One, in accordance with directions given by The Company, except:
- 5.1.1 where otherwise agreed with The Company; or
- 5.1.2 for safety purposes or pursuant to environmental obligations in accordance with Section G, paragraph 2.
- 5.2 Notwithstanding sub-paragraph 5.1.1, but subject at all times to Section G, paragraph 2, each Transmission Owner shall comply with any reasonable direction by The Company to configure any part of its Transmission System.
- 5.3 Any direction from The Company to a Transmission Owner pursuant to paragraphs 5.1 and 5.2 shall be in the form agreed with such Transmission Owner from time to time.
- 5.4 Operational Switching
- 5.4.1 Notwithstanding that a Transmission Owner is not a party to the CUSC and is not thereby required to comply with the Grid Code, a Transmission Owner shall

comply with section OC7.6 of the Grid Code (as amended from time to time) and any Local Switching Procedure agreed pursuant to that section.

- 5.4.2 The Company shall comply with, and shall procure that a User shall comply with section OC7.6 of the Grid Code and any Local Switching Procedure agreed pursuant to that section where and to the extent that such section applies to The Company and the User.

6. THE COMPANY OBLIGATIONS

- 6.1 In co-ordinating and directing the flow of electricity onto and over the National Electricity Transmission System, The Company shall:

6.1.1 take all reasonably practicable steps to determine, and shall ensure, that it does so in accordance with Licence Standards; and

6.1.2 in complying with Licence Standards, ensure that neither:

6.1.2.1 Operational Capability Limits; nor

6.1.2.2 such technical limits or other conditions as The Company becomes aware are necessary and safe in accordance with Good Industry Practice (including, without limitation, any conditions notified to it pursuant to paragraph 4.14),

are exceeded or would be exceeded on the occurrence of a Secured Event.

- 6.2 The Company shall not be in breach of paragraph 6.1 where an Unsecured Event causes or would cause Operational Capability Limits or other relevant limits to be exceeded.

- 6.3 In the event that The Company shall at any time become aware that Operational Capability Limits or, where relevant, other conditions notified to it pursuant to paragraph 4.14 are being or have been exceeded, then The Company shall, in accordance with Licence Standards and in accordance with the agreed procedures for the operation of that Transmission Owner's Transmission System, where applicable, immediately:

6.3.1 direct or configure the relevant Transmission System or take such other steps as are appropriate so that such Operational Capability Limits or other conditions are no longer being exceeded;

6.3.2 inform the relevant Transmission Owner including, without limitation, by providing (in reasonable but not excessive detail) details of and reasons for the Operational Capability Limits or other conditions being exceeded; and

6.3.3 without prejudice to any other rights and remedies arising under this Code, identify and carry out (in consultation with the Transmission Owner where appropriate) such actions as are reasonably necessary and appropriate to ensure that such event shall not re-occur.

- 6.4 The Company shall, and in accordance with the agreed procedures for the operation of that Transmission Owner's Transmission System (except to the extent otherwise agreed with the relevant Transmission Owner) notify a Transmission Owner, as a matter of urgency, if The Company becomes aware (otherwise than from such Transmission Owner) of any Event or circumstance which is or is likely to materially affect such Transmission Owner's provision of Transmission Services in accordance with its Services Capability Specification, including of any current or likely Services Reduction or Services Reduction Risk.

PART TWO: TRANSMISSION OUTAGE PLANNING

1. INTRODUCTION

- 1.1 This Section C, Part Two deals with the placement and implementation of Outages on the National Electricity Transmission System, and sets out the processes for:
- 1.1.1 the co-ordinated development of Outage Proposals by each Transmission Owner;
 - 1.1.2 The Company to prepare Outage Plans for the National Electricity Transmission System taking into account each Transmission Owner's Outage Proposals;
 - 1.1.3 the real-time implementation of each Outage through a pre-agreed Outage Implementation Process; and
 - 1.1.4 provision for the reinstatement of Transmission Services which are the subject of an Outage, where so directed by The Company.

2. OUTAGE PLAN

- 2.1 In accordance with the provisions of this Section C, Part Two, The Company shall develop and maintain a separate Outage Plan of the Outages which are planned to occur on the National Electricity Transmission System in respect of each current and each of the following six Financial Years. Outages may be submitted by a Transmission Owner beyond that period and, where agreed appropriate by The Company and the relevant Transmission Owner, The Company shall maintain them within the Outage Plan.
- 2.2 The Company shall update each Outage Plan from time to time to reflect the best and most current information available to it and so that each contains, to the extent and in such detail as is reasonably practicable and appropriate at the time, a description of those Outages which are planned to occur on the National Electricity Transmission System during the course of the relevant Financial Years. These may include Outages proposed by each Transmission Owner pursuant to this Section C, Part Two and any other Outages which The Company plans in respect of the National Electricity Transmission System.

- 2.3 The Company shall ensure that, to the extent that it is reasonable and appropriate to do so, each Transmission Owner is provided with the most up-to-date version of those parts of each Outage Plan as contain or relate to Outages of, or any other Outages which are likely to materially affect, that Transmission Owner's Transmission System. In each case, The Company shall identify those changes made to an Outage Plan since the last version provided to the relevant Transmission Owner.
- 2.4 In the course of developing its Outage Plans, The Company shall, to the extent that it is reasonable and practicable to do so:
- 2.4.1 discuss and exchange relevant information with each other Party to the extent that such information is likely to have a material effect on the Outages proposed by such other Party and including, without limitation, the data in respect of User Outages set out in Schedule 3; and
- 2.4.2 take into account each Outage Proposal in the preparation of its Outage Plan for the relevant Financial Year (any dispute in relation to the manner in which matters contained in an Outage Proposal are included or not included in an Outage Plan shall be referable to the Authority as a Dispute pursuant to Section H, paragraph 4.1).

3. OUTAGE PROPOSALS

- 3.1 Each Transmission Owner shall co-operate and assist The Company in developing The Company's Outage Plans, including by:
- 3.1.1 developing and maintaining Outage Proposals, in accordance with paragraph 3.2, with the objective of providing The Company with a proposed placement of Outages for each Financial Year that facilitates as co-ordinated and economical placement of Outages on the National Electricity Transmission System as is reasonably foreseeable and practicable, given the information available to such Transmission Owner; and
- 3.1.2 providing The Company with the most up-to-date version of each of its Outage Proposals up until the date on which the final version of each such Outage Proposal is submitted to The Company pursuant to paragraph 3.7.
- 3.2 Each Transmission Owner shall develop and maintain, in consultation with The Company, a separate Outage Proposal of the Outages which are planned to occur on the Transmission Owner's Transmission System in respect of the current and each of the following six Financial Years.
- 3.3 Each Transmission Owner shall update each Outage Proposal from time to time, up until the final version of its Outage Proposal is submitted under paragraph 3.7, to reflect the best and most current information available to it and so that each contains, to the extent and in such detail as is reasonably practicable and appropriate at the time, a description of those Outages which are planned to occur on its Transmission System during the course of the relevant Financial Year.

- 3.4 Each Transmission Owner shall, in preparing its Outage Proposal in respect of each Financial Year, and The Company shall, in planning Outages on its Transmission System in respect of each Financial Year, discuss and exchange relevant information with each other Party to the extent that such information is likely to have a material effect on the Outages of such other Party.
- 3.5 Each Transmission Owner shall develop its Outage Proposals taking into account, to the extent that it is reasonable and practicable to do so, the activities and reasonable requests of each other Party and the information provided to it under this Code.
- 3.6 Each Transmission Owner shall, at the request of The Company, take all reasonably practicable steps to assist The Company in co-ordinating and facilitating User Outages and Outages of each other Party.
- 3.7 On or before Week 28, each Transmission Owner shall submit to The Company the final version of such Transmission Owner's Outage Proposal for the following Financial Year and Key Outage Proposals for Year 2, and shall ensure that such Outage Proposal is as full and complete as reasonably practicable and contains, without limitation:
- 3.7.1 the proposed start and finish date(s) and times of each Outage;
 - 3.7.2 details of the technical limits which the Transmission Owner anticipates will apply to its Transmission Services whilst they are the subject of the Outage (where not otherwise specified, Transmission Services on Outage shall be deemed to be wholly withdrawn);
 - 3.7.3 if necessary, any information about the associated configuration of any parts of the National Electricity Transmission System and associated arrangements that may be required in relation to the Outage;
 - 3.7.4 information to assist The Company with the efficient sequencing of Outages, including the relationship, if any, between each Outage and any other proposed Outages;
 - 3.7.5 an indication of the importance which the Transmission Owner affixes to each Outage;
 - 3.7.6 details of the Transmission Owner's flexibility margins in respect of each Outage (for example, alternative dates upon which they could be taken, or the potential for movement of other Outage dates or times);
 - 3.7.7 the Emergency Return to Service Time for those parts of the Transmission System associated with each Outage (including, where appropriate, a statement of the steps that would be taken to restore the provision of the relevant associated Transmission Services or such alternative steps as The Company and the relevant Transmission Owner may agree which are intended to give a similar or substitutive effect and, where such steps do not restore such Transmission Services to their Normal Capability Limits, the limits which would otherwise apply),

(the matters in sub-paragraphs 3.7.5, 3.7.6 and 3.7.7 being here referred to together as "**Flexibility Parameters**").

- 3.8 Following the submission of its final Outage Proposal pursuant to paragraph 3.7, a Transmission Owner shall not make or submit any further change(s) to its Outage Proposal for the following Financial Year. Key Outage Proposals for Year 2 may be revised at any time until these outages become outages for Year 1, and any further changes to the Outage Plan for such Financial Years shall be made in accordance with paragraph 5.

4. THE COMPANY ISSUE OF THE OUTAGE PLAN

- 4.1 On or before Week 34, The Company shall issue to each Transmission Owner such parts of the Outage Plan for the following Financial Years (being the same Outage Plan from which The Company will circulate relevant information to Users in accordance with Operating Code No.2) as cover Outages of, or any other Outages which are likely to materially affect, that Transmission Owner's Transmission System.
- 4.2 The Company may involve each Transmission Owner, and each Transmission Owner shall participate, as requested by The Company, in any discussions or correspondence with Users and other third parties from time to time relating to any proposed changes to the Outage Plan in respect of Outages of, or any other Outages which are likely to materially affect, such Transmission Owner's Transmission System.
- 4.3 On or before Week 49, The Company shall ensure that the Outage Plan for the following two Financial Years takes into account any information or feedback received from Transmission Owners and from Users and otherwise, and shall revise and re-issue to each Transmission Owner such parts of the Outage Plan as cover Outages of, or any other Outages which are likely to materially affect, that Transmission Owner's Transmission System.
- 4.4 For the avoidance of doubt, any involvement or discussions of Transmission Owners with The Company or Users or other third parties under this paragraph 4 shall be in addition to each Transmission Owner's right to request change(s) to the Outage Plan for the following Financial Years under paragraph 5.

5. CHANGE PROCESS FOLLOWING ISSUE OF FINAL VERSION OF OUTAGE PROPOSAL

- 5.1 This paragraph 5 shall only apply to an Outage Plan from the date on which Transmission Owners are required to have submitted to The Company their final Outage Proposals for the following Financial Year and Key Outage Proposals for Year 2 pursuant to paragraph 3.7.
- 5.2 Each Party shall keep the Outage Plan under review at all times (including up to the end of an Outage) and as soon as a Party becomes aware that a change is required to such Outage Plan, including any requirement for a new Outage or changes to the scheduled dates or times for, or cancellation of, an existing Outage, that Party shall:

- 5.2.1 if it is a Transmission Owner, request a change to the Outage Plan to The Company including with such request a brief description of the reason(s) for the change; or
- 5.2.2 if it is The Company, notify each Transmission Owner that The Company itself requests or another Transmission Owner has requested (where it has received a request under sub-paragraph 5.2.1) a change to the Outage Plan to the extent that it considers that such change affects Outages of, or any other Outages which are likely to materially affect, that Transmission Owner's Transmission System, with a brief description of the reason(s) for the change.
- 5.3 A request made or notice provided pursuant to paragraph 5.2 may be made or provided verbally where it is necessary and expedient to do so, provided that such request or notice is confirmed in writing as soon as reasonably practicable by the Party making it.
- 5.4 Any request for a new Outage made pursuant to paragraph 5.2 shall include, to the extent reasonably practicable, the matters set out in paragraph 3.7.
- 5.5 The obligation set out in paragraph 5.2 shall apply to the review by The Company of the Outage Plan as a whole and by each Transmission Owners only in respect of such parts of the Outage Plan as have been disclosed to it under paragraph 4.3.
- 5.6 The Parties shall at all times up to the end of an Outage also keep the information provided to each other in connection with each Outage in the Outage Plan under review and shall promptly notify each other Party of any changes in circumstances requiring changes to such information.
- 5.7 Following a request for a change to an Outage Plan made pursuant to paragraph 5.2, the Party requesting such change and any Transmission Owners which receive notification pursuant to sub-paragraph 5.2.2 shall agree how the change may be accommodated. Any failure to agree shall be referable by any of the relevant Parties to the Authority as a Dispute in accordance with Section H, paragraph 4.1.
- 5.8 The Company shall promptly update the Outage Plan to adopt any change agreed pursuant to paragraph 5.7 and in the event of a failure to agree The Company may, at its discretion, give effect to a change, including by updating the Outage Plan to adopt such change, subject to any subsequent determination of a Dispute referred to the Authority pursuant to paragraph 5.7.
- 5.9 On and from the date on which The Company re-issues the Outage Plan for the following two Financial Years pursuant to paragraph 4.3, it shall maintain for 5 years a register which records in relation to any request for a change to such Outage Plan which is made after that date in accordance with this paragraph 5 (including any cancellation of an Outage):
- 5.9.1 a description of the change, including (where appropriate) the date(s) and times specified for an Outage in the Outage Plan at the time of the change and as changed;

- 5.9.2 the identity of the Party which proposed or requested the change; and
 - 5.9.3 a brief description of the reason for the change;
 - 5.9.4 a indicator of whether The Company made such a change to the Outage Plan and a brief description of the reasons for the decisions including an indication of any withdrawal of a request for an outage change by the party proposing or requesting the change; and
 - 5.9.5 in relation to an Outage Change (as defined in the licence), the net costs reasonably incurred by the Transmission Owner as a result of the Outage Change as declared to The Company and which are agreed by The Company and the Transmission Owner or where there is a failure to agree, as determined by the Authority following referral to the Authority as a Dispute by any of the relevant Parties in accordance with Section H, paragraph 4.1.
- 5.10 The Company shall make the register in paragraph 5.9 available to each Transmission Owner to the extent that it contains information in respect of Outages of, or any other Outages which are likely to materially affect, that Transmission Owner's Transmission System.

6. IMPLEMENTATION OF OUTAGES

- 6.1 The Company, and each Transmission Owner in relation to whose Transmission System an Outage contained in the Outage Plan is due to occur, shall jointly prepare for such Outage including by agreeing over a reasonably prudent period beforehand the process required (and the associated configuration of the National Electricity Transmission System that will be required) to be undertaken by each Party in order to implement the Outage in accordance with the Outage Plan (the "**Outage Implementation Process**"). Any failure to agree shall be referable to the Authority as a Dispute in accordance with Section H, paragraph 4.1.
- 6.2 In the event that The Company and a Transmission Owner shall at any time be unable to agree the Outage Implementation Process to apply in respect of an Outage, the Outage Implementation Process shall be as directed by The Company subject to the subsequent determination of any Dispute referred to the Authority pursuant to paragraph 6.1.
- 6.3 The Transmission Owner on whose Transmission System an Outage is due to occur or is occurring shall notify The Company of the extent and duration of any change(s) in Operational Capability Limits that will apply to such Transmission Services as are affected by such Outage, in each case:
- 6.3.1 at the same time as the Transmission Owner makes any request to The Company pursuant to paragraph 5.2 which would have the effect of varying a notification already given under this paragraph 6.3; and
 - 6.3.2 immediately following receipt of a direction from The Company for the discontinuance of such Outage pursuant to paragraph 7.

- 6.4 The Company, and the Transmission Owner in relation to whose Transmission System the Outage will occur or is occurring (as appropriate), shall each comply with and undertake such actions as are required of them under and in accordance with the Outage Implementation Process.
- 6.5 Where a Party becomes aware of any matter which may affect its ability to meet its obligations pursuant to an Outage Implementation Process, it shall promptly notify the other Party and both shall agree a change to such Outage Implementation Process. Any failure to agree shall be referable to the Authority as a Dispute in accordance with Section H, paragraph 4.1.
- 6.6 In the event that two Parties shall at any time be unable to agree a change to an Outage Implementation Process under paragraph 6.5, such Outage Implementation Process shall be remain unchanged, subject to the subsequent determination of any Dispute referred to the Authority pursuant to paragraph 6.5.

7. EMERGENCY RETURN TO SERVICE DURING AN OUTAGE

- 7.1 The Company may at any time direct that a Transmission Owner discontinue an Outage within the relevant Emergency Return to Service Time, whether or not expiry of the planned period of the Outage is otherwise imminent, by so notifying the relevant Transmission Owner, provided that:
- 7.1.1 The Company shall consult with such Transmission Owner before issuing any such direction (any dispute in relation to a direction made by The Company pursuant to this paragraph 7.1 shall be referable to the Authority as a Dispute in accordance with Section H, paragraph 4.1); and
- 7.1.2 pending the subsequent resolution of any Dispute referred to the Authority under sub-paragraph 7.1.1, the relevant Transmission Owner shall, if The Company so requests, take the steps proposed in relation to such Outage pursuant to sub-paragraph 3.7.7 of this Section C, Part Two (or as otherwise agreed with The Company) to restore the provision of Transmission Services.
- 7.2 A direction notified pursuant to paragraph 7.1 may be notified verbally where it is necessary and expedient to do so, provided that The Company confirms such direction in writing as soon as reasonably practicable.

PART THREE: OTHER

1. INTRODUCTION

- 1.1 This Section C, Part Three deals with:
- 1.1.1 the Testing of each Transmission Owner's Transmission System and arrangements between the Parties to facilitate the testing and commissioning of User Equipment;

- 1.1.2 Transmission Owners entering into Interface Agreements with Users in relation to Connection Sites and New Connection Sites; and
- 1.1.3 other operational matters including Event Reporting and Joint Investigations, Black Start, and the De-energisation of User Equipment.

2. TESTING TRANSMISSION OWNER'S TRANSMISSION SYSTEMS

2.1 Testing

- 2.1.1 Where reasonably requested by another Party, each Party shall to the extent that it is reasonably practicable for it to carry out Tests on its Transmission System (and in the case of The Company, the National Electricity Transmission System) and shall co-operate with the carrying out of Tests by such other Party on that Party's Transmission System (and where such other Party is The Company, the National Electricity Transmission System).
- 2.1.2 Where reasonably requested by The Company, a Transmission Owner shall provide access to its Test results and maintenance records in relation to any of its Plant or Apparatus located on Users' Sites.

2.2 Commissioning and on-load testing of User Equipment

- 2.2.1 A Transmission Owner shall, where requested by The Company, assist with the commissioning and on-load testing of a User Equipment or equipment for which a User is responsible and The Company shall pay Reasonable Charges to the Transmission Owner in respect of any assistance so provided.

3. REQUIREMENT TO ENTER INTO INTERFACE AGREEMENT

- 3.1 In relation to Connection Sites and New Connection Sites, each Transmission Owner to whose Transmission System such Connection Site or New Connection Site is or will be connected shall, and The Company shall procure that each relevant User shall, enter into an Interface Agreement in a form to be agreed between such Transmission Owner and User but based substantially on the form set out in Exhibit O, Part B to the CUSC where such Interface Agreement(s) is/are required.
- 3.2 In relation to Transmission Interface Sites and New Transmission Interface Sites, each Transmission Owner, to whose Transmission System such Transmission Interface Site is or will be connected (the "**Transmission Interface Site Parties**") shall, enter into a Transmission Interface Agreement.
- 3.3 Each Transmission Interface Agreement shall be in a form agreed between such Transmission Interface Site Parties but based substantially on the form set out in Schedule Fifteen and as drafted in the first instance by the relevant Offshore Transmission Owner.

3.4 In relation to Embedded Transmission Interface Sites and New Embedded Transmission Interface Sites, each Offshore Transmission Owner shall

3.4.1 where required by The Company in order that The Company can comply with its obligations under the Embedded Transmission Bilateral Agreement, enter into an Embedded Transmission Interface Agreement with the relevant Embedded Transmission Counterparty; and

3.4.2 otherwise provide such information, assistance and cooperation as The Company shall require to enable it to identify and agree any requirements to be covered in the Embedded Transmission Bilateral Agreement with the Embedded Transmission Counterparty.

Where the Offshore Transmission Owner wishes the Embedded Transmission Counterparty to enter into an Embedded Transmission Interface Agreement The Company shall make such request of the Embedded Transmission Counterparty but shall not have any obligation to the Offshore Transmission Owner to procure the same.

3.5 A Transmission Owner shall notify The Company as soon as reasonably practicable after it has concluded

3.5.1 a binding Interface Agreement with a User; or

3.5.2 a Transmission Interface Agreement with a Transmission Interface Site Party.

3.5.3 an Embedded Transmission Interface Agreement with a Distribution Network Operator.

3.6 In the case of New Connection Sites and New Transmission Interface Sites that are the subject of an OTSDUW Build Application, the Interface Agreements referred to in paragraphs 3.1 and 3.2 shall be entered into 6 months prior to the proposed OTSUA Transfer Time, or such other dates as, in the case of an Interface Agreement, the Transmission Owner and the User and, in the case of a Transmission Interface Agreement the Transmission Owner and other Transmission Owner, shall agree and in any event by the OTSUA Transfer Time.

4. EVENT REPORTING AND JOINT INVESTIGATIONS

4.1. Notification of Events, Significant Incidents and Possible Relevant Interruptions by Transmission Owners

4.1.1 Each Transmission Owner shall, as soon as it becomes aware of any Event on its Transmission System which has had or may have an Operational Effect on the National Electricity Transmission System or a User System, notify The Company (either verbally or in writing), as a matter of urgency, to the extent that such information is not otherwise provided to The Company pursuant to Section C, Part One, paragraphs 4.4, 4.5 or 4.6.

- 4.1.2 The Company shall, as soon as it becomes aware of any Event on the National Electricity Transmission System or a User System which has had or may have an Operational Effect on a Transmission Owner's Transmission System, notify such Transmission Owner (either verbally or in writing) as a matter of urgency.
- 4.1.3 The Company shall, as soon as it becomes aware of any Event on the Transmission Owner's Transmission System which has led to a Possible Relevant Interruption of an Affected User, notify the relevant Transmission Owner(s) as a matter of urgency.
- 4.1.4 Each Party may (irrespective of whether or not it has received a notification under sub-paragraph 4.1.1 or 4.1.2), in its discretion, determine that an Event is a Significant Incident and request that, where relevant, The Company or any Transmission Owner(s) whose Transmission System(s) has been or may be affected by the Significant Incident prepare and submit a report in accordance with sub-paragraph 4.1.6..
- 4.1.5 Following a notification described in sub-paragraph 4.1.3 The Company may request that the Transmission Owner(s) whose Transmission System(s) has been or may be the cause of the Possible Relevant Interruption of an Affected User prepare and submit a report in accordance with sub-paragraph 4.1.6.
- 4.1.6 Each Party (the "**Responding Party**") shall, if requested to do so by another Party (the "**Requesting Party**") pursuant to sub-paragraph 4.1.4 or 4.1.5, prepare and submit a written report to the Requesting Party as soon as reasonably practicable in relation to a Significant Incident or a Possible Relevant Interruption which shall include, without limitation, the following information:
- 4.1.6.1 a description of the Significant Incident or the Possible Relevant Interruption (including, without limitation, any associated Services Reduction or Service Reduction Risk);
 - 4.1.6.2 the time and date of the Significant Incident; or the Possible Relevant Interruption and the estimated Interruption Period of Possible Relevant Interruption;
 - 4.1.6.3 the location(s) of the Significant Incident or the Possible Relevant Interruption;
 - 4.1.6.4 Plant and/or Apparatus directly involved (and not merely affected by the Event(s) giving rise to the Significant Incident or the Possible Relevant Interruption);
 - 4.1.6.5 a response to any question(s) raised by the Requesting Party in relation to the Event or Significant Incident or the Possible Relevant Interruption; and
 - 4.1.6.6 any other information reasonably requested by the Requesting Party in relation to the Event or Significant Incident or the Possible Relevant Interruption.

- 4.1.7 Each Party shall, where reasonably requested to do so by another Party, assist in answering any questions from or otherwise providing information (in the case of The Company) to a User or in the case of any Party, to any other Party, in relation to an Event or Significant Incident or the Possible Relevant Interruption on such Transmission Owner's Transmission System.
- 4.1.8 If an Affected User has exercised its rights pursuant to paragraph 5.10 of the CUSC The Company and the relevant Transmission Owner will agree whether or not they consider, on the basis of the report submitted under sub-paragraph 4.1.6, that a Possible Relevant Interruption has occurred and the Interruption Period. In the event that the relevant Transmission Owner and The Company do not agree the relevant Transmission Owner or The Company may refer any such failure to agree to arbitration in accordance with Paragraph 5 of Section H.
- 4.1.9 Where The Company and the relevant Transmission Owner agree pursuant to paragraph 4.1.8, or if determined in accordance with Paragraph 5 of Section H, a Possible Relevant Interruption will be treated as a Relevant Interruption.4.2.

Joint Investigations

- 4.2.1 Where a Significant Incident or a Possible Relevant Interruption has occurred and a written report has been submitted to a Requesting Party under sub-paragraph 4.1.4, or 4.1.5 such Requesting Party, or any Party which has submitted a written report in relation to such Significant Incident or, Possible Relevant Interruption, may request in writing to the other, and to any other Party which has been or is likely to be affected by the Significant Incident or Possible Relevant Interruption, that a Joint Investigation be conducted (all Parties participating in a Joint Investigation are referred to collectively as the "**Investigation Parties**").
- 4.2.2 As soon as reasonably practicable following a request under sub-paragraph 4.2.1, the Investigation Parties shall endeavour to agree whether to undertake a Joint Investigation and any matters related to the conduct of such Joint Investigation and which may include, without limitation:
- 4.2.2.1 where requested by The Company, the involvement of any User(s) or other person(s);
- 4.2.2.2 whether the Joint Investigation should also deal with any Related Significant Incidents or Possible Relevant Interruptions;
- 4.2.2.3 the form and rules of and procedure for conducting the Joint Investigation;
- 4.2.2.4 provision for dealing with the costs of the Joint Investigation; and
- 4.2.2.5 provision for the withdrawal of an Investigation Party or other person involved in the Joint Investigation.

4.2.3 For the avoidance of doubt:

4.2.3.1 a Joint Investigation shall not be conducted unless the Investigation Parties have reached agreement pursuant to sub-paragraph 4.2.2; and

4.2.3.2 a Joint Investigation shall not constitute, and shall remain separate from, any Dispute otherwise arising pursuant to Section H.

5. BLACK START

5.1.1 Notwithstanding that a Transmission Owner is not a party to the CUSC and is not thereby required to comply with the Grid Code, a Transmission Owner shall comply with sections OC9.4 and OC9.5 of the Grid Code (as amended from time to time) and any Local Joint Restoration Plan and OC9 De-Synchronised Island Procedure agreed with the Transmission Owner pursuant to those sections.

5.1.2 The Company shall comply with, and shall procure that a User shall comply with sections OC9.4 and OC9.5 of the Grid Code and any Local Joint Restoration Plan or OC9 De-Synchronised Island Procedure agreed pursuant to OC9.4 or OC9.5 where and to the extent that such section applies to The Company and the User.

5.2 In the event of a Total Shutdown or Partial Shutdown, The Company will, as soon as reasonably practical, inform each Transmission Owner (or, in the case of a Partial Shutdown, each Transmission Owner which in The Company's reasonable opinion need to be informed) that a Total Shutdown, or, as the case may be, a Partial Shutdown, exists and that The Company intends to implement a Black Start, following which the Parties shall comply with the processes set out in the arrangements agreed pursuant to paragraph 5.1.

6. ENERGISATION AND DE-ENERGISATION

6.1 On notification from The Company, a Transmission Owner shall promptly comply with any instruction from The Company in relation to:

6.1.1 the Energisation of User Equipment specified in such notice; or

6.1.2 the De-energisation of User Equipment specified in such notice.

7. PROVISION OF TRAINING

7.1 The Company and each Transmission Owner, upon reasonable request from the other including, without limitation, as to numbers and duration, provide such nominated personnel as shall be agreed between The Company and such Transmission Owner and at the expense of the Party providing such training, with training on the processes that The Company or the Transmission Owner (as appropriate) is required to follow, or that it

may otherwise develop, in the discharge of its obligations arising in relation to paragraph 5 of this Part Three.

- 7.2 Any training provided pursuant to paragraph 7.1 shall be in such form and on such terms as the Party providing such training shall, at its discretion, determine is reasonable and both relevant Parties shall co-operate in the performance of such training.
- 7.3 Any dispute arising in relation to the provision of, or failure to provide, training pursuant to this paragraph 7, shall be referable to the Authority as a Dispute in accordance with Section H, paragraph 4.1.

8. NATIONAL ELECTRICITY TRANSMISSION SYSTEM PERFORMANCE REPORTING

- 8.1 The Company shall discuss and evaluate with each Transmission Owner any proposed changes to the statement ("**Condition C17 Statement**") setting out the criteria by which system availability, security and service quality of the National Electricity Transmission System may be measured pursuant to Standard Condition C17 of its Transmission Licence which may be proposed by The Company or a Transmission Owner.
- 8.2 The Company shall, prior to seeking the approval of the Authority for any change to the Condition C17 Statement, consult with each Transmission Owner and take into account any concerns that a Transmission Owner may have regarding changes to the costs it would incur by complying with its obligations under Standard Condition D3 or Standard Condition E16 as applicable of its Transmission Licence as a consequence of any proposed change to the statement.
- 8.3 Parties shall agree a timetable for the key stages of the production of the National Electricity Transmission System Performance Report ("**National Electricity Transmission System Performance Report Timetable**") to enable The Company to meet its obligations for submission of the report to the Authority within the specified timescales of Standard Condition C17. Any failure to agree a National Electricity Transmission System Performance Report Timetable may be referred as a Dispute to the Authority in accordance with Section H, paragraph 4.1.
- 8.4 In the event that The Company and a Transmission Owner fail to agree a National Electricity Transmission System Performance Report Timetable, or any part thereof, then, subject to the determination of any Dispute referred to the Authority pursuant to paragraph 8.3, the Transmission Owner shall comply with such timetable as The Company may specify.
- 8.5 Following the submission of relevant information from each Transmission Owner pursuant to Paragraph 2 of Standard Condition D3 or Standard Condition E16 as applicable of the Transmission Owner's Transmission Licence, The Company shall provide to each Transmission Owner those parts of the initial draft text of the report produced pursuant to Paragraph 3 of Standard Condition C17 of The Company's System Operator Licence ("**National Electricity Transmission System Performance Report**") as are of relevance to it and shall liaise with each of them in order to agree any amendments to the initial draft text of the National Electricity Transmission System Performance Report requested by a Transmission Owner. Any failure to agree such

amendments to the initial draft text of the report may be referred as a Dispute to the Authority in accordance with Section H, paragraph 4.1.

- 8.6 In the event that The Company and a Transmission Owner fail to agree any amendments to the initial draft text of the National Electricity Transmission System Performance Report then, subject to the determination of any Dispute referred to the Authority pursuant to paragraph 8.5, The Company's proposals in respect of such amendments shall prevail.

SECTION D: PLANNING CO-ORDINATION

PART ONE: TRANSMISSION PLANNING

1. INTRODUCTION

1.1 This Section D, Part One deals with the planning and development of Transmission Owners' Transmission Systems and relevant parts of the National Electricity Transmission System on a co-ordinated basis, and sets out:

- 1.1.1 the process for Transmission Owners to develop and implement Transmission Investment Plans in respect of their Transmission Systems;
- 1.1.2 the general principles for identifying the Default Planning Boundary at Connection Sites for the purpose of planning and development;
- 1.1.3 provision for the Parties to co-operate in relation to the preparation by The Company of the Electricity Ten Year Statement;
- 1.1.4 provision for the Parties to co-operate in relation to the preparation by The Company of the Network Options Assessment report; and
- 1.1.5 the process for Transmission Owners providing The Company with the Wider Cancellation Charge Information to enable The Company to prepare the Annual Wider Cancellation Charge Statement.

2. TRANSMISSION PLANNING

2.1 Transmission Investment Plans

- 2.1.1 In accordance with the provisions of this Section D, Part One:
 - 2.1.1.1 each Onshore Transmission Owner shall develop and maintain a separate Transmission Investment Plan in respect of the current and each of the following nine Financial Years; and
 - 2.1.1.2 each Offshore Transmission Owner who plans to make Changes to its Transmission System within the next ten years shall develop and maintain a single Investment Plan in respect of the current and the following nine Financial Years.
- 2.1.2 Each Transmission Owner required to develop and maintain a separate Transmission Investment Plan under sub-paragraph 2.1.1 shall update each Transmission Investment Plan from time to time to reflect the best and most current information available to it and so that each contains, to the extent and in such detail as is reasonably practicable and appropriate at the time, for the relevant Financial Year:

- 2.1.2.1 a description of any proposed Change(s) to its Transmission System;
- 2.1.2.2 a description of any proposed variation(s) in the Transmission Services to be provided to The Company under Section C, Part One, paragraph 2.1 and including (where appropriate) any new or revised Normal Capability Levels that will apply;
- 2.1.2.3 an indication of the works required to give effect to the proposed Changes under sub-paragraph 2.1.2.1 above (here referred to as the "**Planned Works**") and the likely material effect of such Planned Works on Users;
- 2.1.2.4 an indication of any works which a User may have to carry out as a result of any proposed Change to a Connection Site (and/or, in the case of OTSDUW Build, as a result of any proposed Change to a Transmission Interface Site);
- 2.1.2.5 an indication of any Outages (in reasonable but not excessive detail) likely to be required to give effect to the Planned Works;
- 2.1.2.6 a description of any technical or operational assumptions which the Transmission Owner has, in planning and developing its Transmission System, assumed would apply to Plant or Apparatus of another Party or User Equipment at a Connection Site; and
- 2.1.2.7 any other relevant information which the Transmission Owner considers may materially affect a Transmission Investment Plan of another Party, an Offshore Transmission Owner's Transmission System or any OTSDUW.
- 2.1.3 Each Transmission Owner required to develop and maintain a Transmission Investment Plan pursuant to sub-paragraph 2.1.1 shall ensure that, to the extent that it is reasonable and appropriate to do so:
 - 2.1.3.1 The Company is provided with the most up-to-date version of its Transmission Owner's Transmission Investment Plans; and
 - 2.1.3.2 such Transmission Owner provides such parts of the up-to-date versions of its Transmission Investment Plan to each other Transmission Owner as may have a material effect upon that other Transmission Owner's Transmission Investment Plans, or Offshore Transmission Owner's Transmission System,and in each case shall clearly identify those changes made to each Transmission Investment Plan since the last version provided to the relevant Party.
- 2.1.4 [Not Used]
- 2.1.5 [Not Used]
- 2.1.6 The Company shall ensure that, to the extent that it is reasonable and appropriate to do so, each Transmission Owner is provided with any information about

OTSDUW as may have a material effect upon that Transmission Owner's Transmission Investment Plans or Offshore Transmission Owner's Transmission System.

2.2 **Transmission System Technical Criteria and Planning Assumptions**

- 2.2.1 The Company shall prepare and update Planning Assumptions from time to time and shall promptly provide such new or updated Planning Assumptions to Transmission Owners to be used by them in planning and developing their Transmission Systems.
- 2.2.2 A Transmission Owner may at any time submit a request to The Company for a change to Planning Assumptions it has received pursuant to sub-paragraph 2.2.1, provided that such request shall contain a description (in reasonable but not excessive detail) of the reason(s) for the request.
- 2.2.3 If The Company receives a request for a change to Planning Assumptions pursuant to sub-paragraph 2.2.2 it shall, as soon as reasonably practicable:
 - 2.2.3.1 notify the Transmission Owner submitting the request and any other Transmission Owner, which is likely to be materially affected by the requested change, whether or not and, where relevant, how The Company intends to accommodate such request; and
 - 2.2.3.2 where relevant, change and re-issue such Planning Assumptions (and any related Planning Assumptions) accordingly.
- 2.2.4 A Transmission Owner may refer to the Authority as a Dispute in accordance with Section H, paragraph 4.1:
 - 2.2.4.1 any notice received from The Company under 2.2.3.1; or
 - 2.2.4.2 any failure by The Company to respond to a request submitted under sub-paragraph 2.2.2 within a reasonable period of time, taking into account the nature, complexity and urgency of the request.
- 2.2.5 Notwithstanding any request submitted by a Transmission Owner pursuant to sub-paragraph 2.2.2 above, each Transmission Owner shall continue to take into account the Planning Assumptions provided by The Company, for the purposes of sub-paragraph 2.2.7 of this Section D, Part One, subject to any subsequent changes made to such Planning Assumptions by The Company under sub-paragraph 2.2.3 or any determination of a Dispute referred to the Authority pursuant to sub-paragraph 2.2.4.
- 2.2.6 Without limitation to Section C, Part One, paragraph 2.2, in planning and developing its Transmission System, each Transmission Owner shall ensure that its Transmission System complies with:

2.2.6.1 the minimum technical, design and operational criteria and performance requirements set out or referred to in Connection Conditions 6.1, 6.2, 6.3 and 6.4 as applicable to Type 1 Transmission Owners or European Connection Conditions 6.1, 6.2, 6.3 and 6.4 as applicable to Type 2 Transmission Owners and in Planning Code 6.2 and/or 6.3; or

2.2.6.2 such other technical criteria or requirements as apply to any relevant part of its Transmission System by virtue of a current Transmission Derogation; and

in the case of an Offshore Transmission System, each Transmission Owner shall also ensure that:

2.2.6.3 its Transmission System meets the minimum technical, design and operational criteria and performance requirements set out or referred to in Section K of this Code;

2.2.7 Each Transmission Owner shall plan and develop its Transmission System taking into account the Planning Assumptions provided to it by The Company and any other information provided to it under this Code and on the basis that User Plant and Apparatus complies with:

2.2.7.1 the minimum technical design and operational criteria and performance requirements set out in Connection Conditions 6.1, 6.2, 6.3 and 6.4 as applicable to Type 1 Transmission Owners or European Connection Conditiond 6.1, 6.2, 6.3 and 6.4 as applicable to Type 2 TransmissionnOwners: or

2.2.7.2 such other criteria or requirements as The Company may from time to time notify the Transmission Owner are applicable to specified User Plant and Apparatus pursuant to sub-paragraph 2.2.8; and

2.2.7.3 in relation to each Connection Site, such technical design and operational criteria as are set out in the Connection Site Specification,

and, unless otherwise advised by the relevant Party, that each other Party complies with the provisions of this Code and any applicable Licence Standards in planning or developing any other part of the National Electricity Transmission System.

2.2.8 The Company shall notify each Transmission Owner whose Transmission System is likely to be materially affected by the design or operation of a User's Plant and Apparatus where The Company:

2.2.8.1 becomes aware that such User has or is likely to apply for a User Derogation;

2.2.8.2 is itself applying for a derogation under the Grid Code in relation to the Connection Site on which such User's Plant and Apparatus is located or to which it otherwise relates; or

2.2.8.3 is otherwise notified by such User that specified Plant or Apparatus is normally capable of operating at levels better than those set out in Connection Conditions 6.1, 6.2, 6.3 and 6.4 as applicable to GB Code User's or European Connection Conditions 6.1, 6.2, 6.3 and 6.4 as applicable to EU Code User's.

2.2.9 Each Transmission Owner shall promptly notify The Company if such Transmission Owner becomes aware that a User's Plant or Apparatus has failed, or is likely to fail, otherwise than in accordance with a User Derogation, to comply with the technical design and operational criteria or performance requirements applying pursuant to sub-paragraph 2.2.7.

2.3 Co-ordination of Transmission Investment Planning

2.3.1 Transmission Owners required to develop and maintain an Investment Plan pursuant to sub-paragraph 2.1.1 and Offshore Transmission Owners where required under Paragraph 2.3.2 shall, at all times:

2.3.1.1 co-operate and assist each other in the development and implementation of co-ordinated Transmission Investment Plans and Changes to an Offshore Transmission System;

2.3.1.2 meet from time to time (including by telephone if the Parties so agree) to agree arrangements to facilitate such development and implementation; and

2.3.1.3 plan and develop their Transmission Systems taking into account, to the extent that it is reasonable and practicable to do so, the activities and reasonable requests of each other Party relating to the planning and development of such other Party's Transmission System.

2.3.2 Each Offshore Transmission Owner shall assess the impact on its Offshore Transmission System of planned Changes in Transmission Owners' Transmission Investment Plans. Each Offshore Transmission Owner shall notify The Company and any relevant Transmission Owners of any potential need to make Changes to its Offshore Transmission System as a consequence of planned Changes on another Party's Transmission System. On receipt of such notification, and where required by The Company or a Relevant Transmission Owner, to do so shall participate under sub-paragraph 2.3.1.

2.3.3 Where Transmission Owners agree that a Change is necessary to an Offshore Transmission System as a result of another Transmission Owner's Transmission Investment Plan, that Transmission Owner shall compensate the Offshore Transmission Owner for the reasonable and proper cost and expense of such Change to the Offshore Transmission System.

- 2.3.4 [Not used]
- 2.3.5. Without limitation to sub-paragraph 2.3.1, each Transmission Owner shall include in its Transmission Investment Plans such information directly related to the matters set out in sub-paragraphs 2.1.2.1 to 2.1.2.6 or the current or future characteristics of the Transmission Owner's Transmission System and such information about OTSDUW, as:
- 2.3.5.1 The Company reasonably requests; or
- 2.3.5.2 a Transmission Owner reasonably requests (to the extent that the information requested may have a material effect upon the requesting Transmission Owner's Transmission Investment Plan(s)).

2.4 **Changes to Transmission Investment Plans**

- 2.4.1 For the avoidance of doubt, a Transmission Owner may change any part of its Transmission Investment Plan(s) at any time, provided that the Party making such change provides an updated version of its Transmission Investment Plan to other relevant Parties in accordance with sub-paragraphs 2.1.3 or 2.1.6.
- 2.4.2 A Party may at any time submit to another Party a request ("**Planning Request**") for a change to such parts as it has been provided with pursuant to sub-paragraphs 2.1.3 or 2.1.6 of, in the case where such other Party is a Transmission Owner, that other Party's Transmission Investment Plan(s) provided that each Planning Request shall:
- 2.4.2.1 contain a description of the requested change (in reasonable but not excessive detail) and the reason for the Planning Request; and
- 2.4.2.2 be submitted as soon as reasonably practicable after the Party submitting the Planning Request becomes aware of the need for such change.
- 2.4.3 A Party which receives a Planning Request under sub-paragraph 2.4.2 shall notify the Party which submitted such Planning Request whether or not and, where relevant, how it intends to accommodate the Planning Request and shall, as soon as reasonably practicable, update its Transmission Investment Plan(s) accordingly.
- 2.4.4 A Party may refer to the Authority as a Dispute in accordance with Section H, paragraph 4.1:
- 2.4.4.1 any notice issued under sub-paragraph 2.4.3 in response to a Planning Request; or
- 2.4.4.2 any failure by a Party to respond to a Planning Request within a reasonable period of time, taking into account the nature, complexity and urgency of the Planning Request.

2.4.5 Each Transmission Investment Plan shall be developed and implemented as proposed by the Party required to develop and maintain it under this Section D, Part One, subject to the subsequent determination of any Dispute referred to the Authority pursuant to sub-paragraph 2.4.4.

2.5 Arrangements with Users concerning Modifications (including Replacement of Assets)

2.5.1 The Company shall identify those Planned Works of each Transmission Owner which will require arrangements to be made between The Company and Users in relation to a Modification (including, for the avoidance of doubt, any Replacement of Assets) and, taking into account the point in time at which The Company was first made aware of Planned Works, shall:

2.5.1.1 take all reasonably practicable steps to make such arrangements within the time required to enable such Transmission Owner to undertake the Planned Works in accordance with its Transmission Investment Plan; and

2.5.1.2 promptly notify such Transmission Owner of any such Modification and keep it informed of The Company's progress in making such arrangements (including, without limitation, notifying it of any determination by the Authority in relation to a dispute between The Company and a User which is relevant to such Planned Works).

2.5.2 Subject to sub-paragraph 2.5.5, where The Company identifies that Planned Works proposed by a Transmission Owner constitute a Modification and require arrangements to be made with a User, such Transmission Owner shall not undertake such Modification otherwise than in accordance with the provisions of Section D, Part Two and any relevant TO Construction Agreement.

2.5.3 Each Transmission Owner shall comply with any reasonable request from The Company for such assistance or further information as The Company requires in connection with identifying or making arrangements with Users pursuant to 2.5.1.

2.5.4 For the avoidance of doubt, and subject to sub-paragraph 2.5.5, a Transmission Owner shall not undertake any Modification unless and until The Company has notified such Transmission Owner that The Company has either agreed such Modification with the affected User or that any dispute between The Company and the User in relation to such Modification has been determined by the Authority pursuant to the CUSC.

2.5.5 Each Transmission Owner shall take all reasonable steps to avoid exercising its rights pursuant to this sub-paragraph 2.5.5 but, in the event that it has reasonable grounds to believe, given its Transmission Licence and statutory duties, that a Transmission Connection Asset should be replaced prior to notice being received pursuant to sub-paragraph 2.5.4, the Transmission Owner shall consult with The Company as far as reasonably practicable but shall be entitled to replace such Transmission Connection Asset.

2.6 Connection Site Specification

- 2.6.1 Each Transmission Owner shall have and maintain, at all times, a specification ("**Connection Site Specification**") which sets out the following information in relation to each Connection Site located on its Transmission System:
- 2.6.1.1 a description of the Transmission Connection Assets at the Connection Site and a clear identification of the boundary between Transmission Connection Assets and User Equipment;
 - 2.6.1.2 any information reasonably requested by The Company in order to enable The Company to settle or amend its bilateral agreement with such User in respect of the Connection Site;
 - 2.6.1.3 a description of the technical design and operational criteria which the Transmission Owner, in planning and developing its Transmission System, had assumed would apply to User Equipment at the Connection Site or to User Equipment of Embedded Users;
- 2.6.2 Each Transmission Owner shall submit to The Company a **Connection Site Specification** as described in Section D, Part One, sub-paragraph 2.6.1 as and when any information contained in such a **Connection Site Specification** is amended.
- 2.6.3 A dispute in relation to any change made to the Connection Site Specification by a Transmission Owner, or the reasonableness of a request for information made by The Company pursuant to sub-paragraph 2.6.1.2, may be referred as a Dispute to the Authority pursuant to Section H, paragraph 4.1.
- 2.6.4 Each Connection Site Specification shall be as proposed by the relevant Transmission Owner, subject to the subsequent determination of any Dispute referred to the Authority pursuant to sub-paragraph 2.6.3.

2.7 Transmission Interface Site Specification

- 2.7.1 At each Transmission Interface Site, each of the relevant Transmission Interface Site Parties shall have and maintain, at all times, a specification ("**Transmission Interface Site Specification**") which sets out:
- 2.7.1.1 a description of their Transmission Interface Assets at the Transmission Interface Site and a clear identification of the boundary between their Transmission Interface Assets and any other Transmission Interface Assets at that Transmission Interface Site;
 - 2.7.1.2 a description of the technical, design and operational criteria which that Transmission Interface Site Party has applied to its equipment in planning and developing its Transmission System.

- 2.7.2 Each Transmission Interface Site Party shall submit to the other relevant Transmission Interface Site Parties a new Transmission Interface Site Specification as described in Section D, Part One, sub-paragraph 2.7.1 as and when any information contained in such a Transmission Interface Site Specification is amended.
- 2.7.3 At Transmission Interface Sites the Transmission Owner shall supply The Company with a copy of a Transmission Interface Site Specification as and when any information contained in such a Transmission Interface Site Specification is amended.
- 2.7.4 A dispute in relation to any change made to a Transmission Interface Site Specification by a Transmission Interface Site Party, may be referred as a Dispute to the Authority pursuant to Section H, paragraph 4.1; and
- 2.7.5 Each Transmission Interface Site Specification shall be as proposed by the relevant Transmission Interface Site Party, subject to the subsequent determination of any Dispute referred to the Authority pursuant to sub-paragraph 2.7.4.

2.8 **Embedded Transmission Interface Site Specification**

- 2.8.1 Each Transmission Owner shall have and maintain, at all times, a specification ("**Embedded Transmission Interface Site Specification**") which sets out the following information in relation to each Embedded Transmission Interface Site located on its Transmission System:
 - 2.8.1.1 a description of the Embedded Transmission Interface Assets at the Embedded Transmission Interface Site and a clear identification of the boundary between Embedded Transmission Interface Assets and Embedded Transmission Counterparty Equipment;
 - 2.8.1.2 any information reasonably requested by The Company in order to enable The Company to settle or amend its Embedded Transmission Bilateral Agreement in respect of the Embedded Transmission Interface Site;
 - 2.8.1.3 a description of the technical design and operational criteria of the Embedded Transmission Counterparty Equipment at the Embedded Transmission Interface Site which the Transmission Owner, has used in planning and developing its Transmission System,
- 2.8.2 Each Transmission Owner shall submit to The Company a Embedded Transmission Interface Site Specification as described in Section D, Part One, sub-paragraph 2.8.1 as and when any information contained in such a Embedded Transmission Interface Site Specification is amended.
- 2.8.3 A dispute in relation to any change made to the Embedded Transmission Interface Site Specification by a Transmission Owner, or the reasonableness of a request

for information made by The Company pursuant to sub-paragraph 2.8.1.2, may be referred as a Dispute to the Authority pursuant to Section H, paragraph 4.1.

2.8.4 Each Embedded Transmission Interface Site Specification shall be as proposed by the relevant Transmission Owner, subject to the subsequent determination of any Dispute referred to the Authority pursuant to sub-paragraph 2.8.3.

2.9 **Transmission Owner Derogated Plant**

2.9.1 A Transmission Owner shall, where requested by The Company, use all reasonable endeavours to carry out such Planned Works as are necessary to ensure that each item of Derogated Plant owned or operated by such Transmission Owner is brought up to the Required Standard applicable to it no later than the Back Stop Date applicable to it.

2.10 **Implementation**

2.10.1 Each Transmission Owner shall give effect to its Transmission Investment Plans .

2.10.2 Where a Transmission Owner develops its Transmission System as a consequence of giving effect to its Transmission Investment Plan pursuant to sub-paragraph 2.10.1, it shall promptly update its:

2.10.2.1 Services Capability Specification to reflect each variation to the Transmission Services it provides under Section C, Part One (including by inserting or amending any applicable Normal Capability Limits);

2.10.2.2 Connection Site Specification to reflect any changes to the Transmission Connection Assets or User Equipment at a Connection Site located on such Transmission Owner's Transmission System; and

2.10.2.3 Transmission Interface Site Specifications to reflect any changes to its Transmission Interface Assets at Transmission Interface Sites.

2.10.2.4 Embedded Transmission Interface Site Specifications to reflect any changes to its Embedded Transmission Interface Assets at Transmission Interface Sites.

2. 10.3 [Not Used]

2. 10.4 Without limitation to sub-paragraph 2.3.1, the Parties shall give effect to their Transmission Investment Plans in a co-ordinated manner and taking into account, to the extent that it is reasonable and practicable for each Party to do so, the activities and requirements of each of the other Parties including, where reasonably requested to do so by another Party, by:

2.10.4.1 undertaking any incidental activities or works which that other Party reasonably identifies are required to facilitate the development of such other Party's Transmission System pursuant to sub-paragraph 2.8.1; and

2.10.4.2 giving advice or assistance in order to enable that other Party to obtain such Consents as that Party may require.

OTSDUW Phased Build

2.11.1 Where a Transmission Owner's Transmission System is extended as a consequence of OTSDUW Phased Build, it shall promptly update its:

2.11.1.1 Services Capability Specification to reflect each variation to the Transmission Services it provides under Section C, Part One (including by inserting or amending any applicable Normal Capability Limits);

2.11.1.2 Connection Site Specification to reflect any changes to the Transmission Connection Assets or User Equipment at a Connection Site located on such Transmission Owner's Transmission System; and

2.11.1.3 Transmission Interface Site Specifications to reflect any changes to its Transmission Interface Assets at Transmission Interface Sites.

2.11.2 In the case of OTSDUW Phased Build, the Transmission Owner of the Transmission System which is to be extended by the OTSDUW Phased Build shall act in a co-ordinated manner and take into account, to the extent that it is reasonable and practicable for each Party to do so, the activities and requirements of each of the other Parties including, where reasonably requested to do so by another Party, by:

2.11.2.1 undertaking any incidental activities or works which that other Party reasonably identifies are required to facilitate the development of such other Party's Transmission System pursuant to sub-paragraph 2.8.1; and

2.11.2.2 giving advice or assistance in order to enable that other Party to obtain such Consents as that Party may require.

3. DEFAULT PLANNING BOUNDARY

3.1 For the purposes of planning and developing Construction Projects in accordance with Section D, Part Two and subject to any contrary agreement between the relevant Transmission Owner and The Company (which agreement shall include, for these purposes, the Connection Site Specification and any TO Construction Agreements), the Default Planning Boundary shall be at the electrical boundary, such boundary to be determined in accordance with the following principles:

3.1.1 in relation to Plant and Apparatus located between the Transmission System and a Power Station, the electrical boundary is at the busbar clamp on the busbar side of the busbar isolators on Generators and Power Station transformer circuits;

3.1.2 save as specified in sub-paragraph 3.1.3 below, in relation to Plant and Apparatus located between the Transmission System and a Distribution System, the electrical boundary is at the busbar clamp on the busbar side of the Distribution System

voltage busbar selector isolator(s) of the Transmission System circuit or if a conventional busbar does not exist, an equivalent isolator. If no isolator exists an agreed bolted connection at or adjacent to the tee point shall be deemed to be an isolator for these purposes;

3.1.3 in relation to Plant and Apparatus located between the Transmission System and a Distribution System and forming a part of the Transmission System but designed for a voltage of 132kV or below in England and Wales, and below 132kV in Scotland, the electrical boundary is at the busbar clamp on the busbar side of the busbar selector isolator on the Distribution System circuit or, if a conventional busbar does not exist, an equivalent isolator. If no isolator exists, an agreed bolted connection at or adjacent to the tee point shall be deemed to be an isolator for these purposes;

3.1.4 in relation to Plant and Apparatus located between the Transmission System and the system of a Non-Embedded Customer, the electrical boundary is at the clamp on the circuit breaker side of the cable disconnections at the Non-Embedded Customer's sub-station; and

3.1.5 in the case of a metal clad switchgear bay the electrical boundary will be the equivalent of those specified in this paragraph 3.1 save that:

3.1.5.1 for rack out switchgear, the electrical boundary will be at the busbar shutters;

3.1.5.2 for SF6 switchgear, the electrical boundary will be at the gas zone separators on the busbar side of the busbar selection devices.

3.1.6 in relation to Plant and Apparatus located between the National Electricity Transmission System and an Interconnector at the busbar clamp on the busbar side of the busbar isolators in the Interconnector transformer circuits at a Connection Site.

3.2 If, in accordance with a request received from a User, The Company wants to use, at a Connection Site, transformers of specialised design for unusual load characteristics at the electrical boundary, these shall form part of the relevant Transmission Owner's Transmission System but The Company shall pay the Transmission Owner for the proper and reasonable additional cost thereof as identified by the Transmission Owner in the TO Connection Offer covering such transformers. In this paragraph 3.2 "unusual load characteristics" means loads which have characteristics which are significantly different from those of the normal range of domestic, commercial and industrial loads (including loads which vary considerably in duration or magnitude).

3.3 For the avoidance of doubt nothing in this paragraph 3 shall effect any transfer of ownership in any Plant and Apparatus.

4. ELECTRICITY TEN YEAR STATEMENT

4.1 Preparation of Electricity Ten Year Statement

- 4.1.1 The Company shall, prior to seeking the approval of the Authority for a form of Electricity Ten Year Statement pursuant to Standard Condition C11 of its Transmission Licence ("**Electricity Ten Year Statement**"), consult with each Transmission Owner and take into account any concerns that a Transmission Owner may have regarding changes to the costs it would incur by complying with its obligations under sub-paragraph 4.1.2 as a consequence of any proposed change in the form of the Electricity Ten Year Statement.
- 4.1.2 The Company shall agree with each Transmission Owner a programme of activities required to be undertaken by that Transmission Owner in order to support The Company in The Company's preparation of each Electricity Ten Year Statement ("**ETYS Programme**") and that Transmission Owner shall carry out such activities as are specified in the ETYS Programme. Any failure to agree an ETYS Programme may be referred as a Dispute to the Authority in accordance with Section H, paragraph 4.1.
- 4.1.3 In the event that The Company and a Transmission Owner fail to agree an ETYS Programme, or any part thereof, then, subject to the determination of any Dispute referred to the Authority pursuant to sub-paragraph 4.1.2, the Transmission Owner shall carry out such ETYS Programme as The Company may specify.
- 4.1.4 The Company shall provide to each Transmission Owner those parts of the initial draft text of each Electricity Ten Year Statement as are of relevance to it and shall liaise with each of them in order to agree any amendments to the initial draft text of the Electricity Ten Year Statement requested by a Transmission Owner. Any failure to agree such amendments may be referred as a Dispute to the Authority in accordance with Section H, paragraph 4.1.
- 4.1.5 In the event that The Company and a Transmission Owner fail to agree any amendments to the initial draft text of the Electricity Ten Year Statement then, subject to the determination of any Dispute referred to the Authority pursuant to sub-paragraph 4.1.4, The Company's proposals in respect of such amendments shall prevail.
- 4.1.6 For the avoidance of doubt, nothing in this paragraph 4.1 shall preclude the Parties from progressing activities pursuant to sub-paragraphs 4.1.1, 4.1.2 and 4.1.4 at the same time.

5. NETWORK OPTIONS ASSESSMENT PROCESS

5.1 Preparation of the Network Options Assessment process and reporting requirements

- 5.1.1 The Company shall, prior to seeking the approval of the Authority for a form of the report and methodology for the Network Options Assessment pursuant to Special Condition C27: The Network Options Assessment process and reporting requirements of its Transmission Licence, consult with each Transmission Owner.

5.1.2 The Company shall agree with each Transmission Owner a programme of activities required to be undertaken by that Transmission Owner in order to support The Company in The Company's:

5.1.2.1 preparation of each Network Options Assessment process and report

5.1.2.2 assessment of the options to deliver Major National Electricity Transmission System Reinforcements (as defined in the "Network Options Assessment Methodology"); and

5.1.2.3 assessment of the options to deliver additional interconnector capacity,

Each Transmission Owner shall carry out such activities as are specified in the NOA Programme. Any failure to agree a NOA Programme may be referred as a Dispute to the Authority in accordance with Section H, paragraph 4.1.

5.1.2A If requested by the Transmission Owner to do so, The Company shall provide the information, analysis and support to such Transmission Owner as provided for under C27 Part C of the Transmission Licence.

5.1.3 In the event that The Company and a Transmission Owner fail to agree a NOA Programme, or any part therefore, then, subject to the determination of any Dispute referred to the Authority pursuant to sub-paragraph 5.1.2, the Transmission Owner shall carry out such NOA Programme as The Company may specify.

5.1.4 The Company shall provide to each Transmission Owner those parts of the initial draft text of each Network Options Assessment report as are of relevance to it and shall liaise with each of them in order to agree any amendments to the initial draft text of the Network Options Assessment report requested by a Transmission Owner. Any failure to agree such amendments may be referred as a Dispute to the Authority in accordance with Section H, paragraph 4.1.

5.1.5 In the event that The Company and a Transmission Owner fail to agree any amendments to the initial draft text of the Network Options Assessment Report then subject to the determination of any Disputes referred to the Authority pursuant to sub-paragraph 5.1.4, The Company's proposals in respect of such amendments shall prevail.

5.1.6 For the avoidance of doubt, nothing in this paragraph 5.1. shall preclude the Parties from progressing activities pursuant to sub-paragraphs 5.1.1, 5.1.2 and 5.1.4 at the same time.

6. ANNUAL WIDER CANCELLATION CHARGE STATEMENT

6.1 Each Transmission Owner shall provide The Company with the Wider Cancellation Charge Information (in the form agreed by the Transmission Owner and The Company) and in accordance with following timescales (or such other timescales as agreed by the Transmission Owner and The Company):

- 6.1.1 for the first Annual Wider Cancellation Charge Statement by the date agreed by the Parties as being sufficient to enable The Company to prepare and publish the first Annual Wider Cancellation Charge Statement in accordance with the CMP 192 Transition Process Plan; and
- 6.1.2 for subsequent Annual Wider Cancellation Charge Statements by no later than 1 of December in the Financial Year preceding the Financial Year to which the Annual Wider Cancellation Charge Statement relates.

PART TWO: CONSTRUCTION

1. INTRODUCTION

1.1 This Section D, Part Two, deals with arrangements between The Company and Transmission Owners in relation to Construction Projects on or which otherwise materially affect such Transmission Owners' Transmission Systems (including in relation to OTSDUW), and the disconnection of Users connected to Transmission Owners' Transmission Systems. This Part Two includes paragraphs relating to:

- 1.1.1 the process by which The Company and each Transmission Owner enter into a bilateral TO Construction Agreement for the construction of a New Connection or Modification or System Construction (or, in the case of OTSDUW Build, the process by which an Offshore Transmission Owner provides the OTSDUW Completion Report);
- 1.1.2 Communications Plant requirements at Connection Sites;
- 1.1.3 provision for the permanent disconnection of User Equipment connected to a Transmission Owner's Transmission Systems; and
- 1.1.4 arrangements for the amendments of TO Construction Agreements and the provision by each Transmission Owner of the information regarding Attributable Works to enable the implementation by The Company of the User Commitment Methodology.

2. THE COMPANY CONSTRUCTION APPLICATIONS

2.1 In this Code:

- 2.1.1 "**Construction Project**" refers (as appropriate) to a New Connection (including New Connections resulting from OTSDUW Build), Modification or a System Construction; and
- 2.1.2 "**The Company Construction Application**" refers to an application submitted by The Company to a Transmission Owner in relation to a Construction Project, and which is (as appropriate) a:

2.1.2.1 The Company Connection Application;

2.1.2.2 The Company Modification Application; or

2.1.2.3 System Construction Application.

2.2 If The Company considers it may be necessary for a Construction Project to be undertaken, it shall submit The Company Construction Application in accordance with paragraph 2.3 to:

2.2.1 the Transmission Owner, if any, whose Transmission System is located at the Relevant Connection Site;

2.2.2 any Transmission Owner in relation to whose Transmission System the Relevant Connection Site satisfies the criteria set out in Schedule Four;

2.2.3 any Onshore Transmission Owner whose Transmission System is located at the point where it has been assumed by The Company that a new Offshore Transmission System (including one delivered through OTSDUW build) required to connect the Relevant Connection Site will connect to an Onshore Transmission System;

2.2.4 a nominated Offshore Transmission Owner whose Transmission System (including one delivered through OTSDUW build) will be located at the Relevant Connection Site;

2.2.5 any Transmission Owner which does not receive The Company Construction Application pursuant to sub-paragraphs 2.2.1, 2.2.2, 2.2.3 or 2.2.4, but which:

2.2.5.1 otherwise receives Construction Planning Assumptions pursuant to paragraph 3.2 in relation to the Relevant Connection Site; or

2.2.5.2 The Company otherwise identifies is likely to be required to enter into a TO Construction Agreement in respect of the Construction Project,

(The Company and each Transmission Owner which receives a The Company Construction Application shall be referred to in this Section as a "**Construction Party**").

2.3 The Company shall submit a The Company Construction Application:

2.3.1 pursuant to sub-paragraphs 2.2.1 and 2.2.2, as soon as reasonably practicable, and in any event within three Business Days of the User Application Date in relation to such Relevant Connection Site;

2.3.2 pursuant to 2.2.3, as soon as reasonably practicable, and in any event to the Onshore Transmission Owner within three Business Days of the User Application Date in relation to such Relevant Connection Site;

2.3.3 pursuant to 2.2.4, as soon as reasonably practicable, and to the Offshore Transmission Owner within three Business Days of such Offshore Transmission Owner acceding to this Code;

- 2.3.4 pursuant to sub-paragraph 2.2.3 where it relates to a The Company Modification Application as a consequence of the nomination of an Offshore Transmission Owner, as soon as reasonably practicable, and in any event within three Business Days of such Offshore Transmission Owner acceding to this Code; and
 - 2.3.5 pursuant to sub-paragraph 2.2.5, at the same time as Construction Planning Assumptions are submitted to a Transmission Owner under paragraph 3.2 or, where applicable, at the same time as The Company gives a Transmission Owner notice under paragraph 3.3.
- 2.4 For the purposes of this Section D, Part Two, a The Company Construction Application shall be deemed to be effective if it is complete and clear in all material respects.
- 2.5 If a Transmission Owner reasonably considers that a The Company Construction Application is not effective it shall, as soon as reasonably practicable and in any event within five Business Days of receipt of The Company Construction Application, notify The Company of:
- 2.5.1 the detailed reasons why it considers The Company Construction Application is incomplete or unclear in a material respect; and
 - 2.5.2 the amendments (including clarifications, additional information, data or other material) it considers are required to make The Company Construction Application effective,
- and shall otherwise use its best endeavours to liaise with and assist The Company (and, where reasonably requested by The Company, any relevant third parties) so that The Company Construction Application is made effective as soon as reasonably practicable. Any dispute in relation to the effectiveness of a The Company Construction Application may be referred as a Dispute to the Authority in accordance with Section H, paragraph 4.1.
- 2.6 Each Transmission Owner (except a nominated Offshore Transmission Owner whose Transmission System to provide the New Connection is to be delivered through OTSDUW Build) shall charge The Company and The Company shall pay Engineering Charges in relation to a The Company Construction Application in accordance with Schedule Ten.
- 2.7 The Company shall immediately notify each other Construction Party following:
- 2.7.1 any change in The Company Construction Application or associated information provided to such Construction Party; or
 - 2.7.2 the withdrawal of the relevant User Application by a User, in which case such notice shall also constitute notice of withdrawal by The Company of any relevant The Company Construction Application.
- 3. PROVISION OF CONSTRUCTION PLANNING ASSUMPTIONS FOLLOWING THE COMPANY CONSTRUCTION APPLICATION**

- 3.1 The Company shall prepare and update **Construction Planning Assumptions** from time to time and shall promptly provide such new or updated Construction Planning Assumptions to Transmission Owners to assist in the preparation of TO Construction Offers. Such Construction Planning Assumptions shall only be used by each Transmission Owner in preparation of TO Construction Offers.
- 3.2 If The Company generates an updated set of Construction Planning Assumptions pursuant to paragraph 3.1, it shall:
- 3.2.1 immediately provide to each Transmission Owner such parts of the set of Construction Planning Assumptions as The Company reasonably determines are likely to materially affect such Transmission Owner's Transmission System; and
- 3.2.2 at the same time as Construction Planning Assumptions are provided to any Transmission Owner(s) pursuant to sub-paragraph 3.2.1, either:
- 3.2.2.1 identify The Company Construction Application already submitted to such Transmission Owner under sub-paragraphs 2.2.1, 2.2.2, 2.2.3 or 2.2.4 to which the Construction Planning Assumptions relate; or
- 3.2.2.2 submit a new The Company Construction Application to such Transmission Owner pursuant to sub-paragraph 2.2.5.
- 3.3 The Company shall notify each Transmission Owner which receives an The Company Construction Application as soon as reasonably practicable and, in any event:
- 3.3.1 in the case of an Offshore Transmission Owner who was not an STC Party at the User Application Date, within two Business Days of that Offshore Transmission Owner's accession to this Code; or
- 3.3.2 in all other cases within two Business Days of the User Application Date,
- if it does not intend to generate a set of Construction Planning Assumptions in respect of the relevant Construction Project. In such circumstances The Company shall specify the relevant Construction Planning Assumptions which it has previously provided to the relevant Transmission Owner and the data of such provisions which shall be deemed to be the Construction Planning Assumptions for the purposes of such Construction Project.
- 3.4 The Company may, at its discretion, change a set of Construction Planning Assumptions (including any deemed Construction Planning Assumptions under paragraph 3.3) by giving notice to the relevant Transmission Owner(s), at any time up to the later of the time at which the TO Construction Offer to which such Construction Planning Assumptions apply:
- 3.4.1 is accepted by The Company pursuant to paragraph 5.3; or
- 3.4.2 no longer remains open for acceptance pursuant to paragraph 5.1.
- 3.5 A Transmission Owner may submit a request to The Company for a change to Construction Planning Assumptions it has received pursuant to paragraphs 3.2 or 3.4 or which have

been deemed pursuant to paragraph 3.3, provided that such request shall contain a description (in reasonable but not excessive detail) of the reason(s) for the request.

3.6 If The Company receives a request for a change to Construction Planning Assumptions pursuant to paragraph 3.5 it shall, as soon as reasonably practicable:

3.6.1 notify the Transmission Owner submitting the request and any other Transmission Owner, which is likely to be materially affected by the requested change, whether or not and, where relevant, how The Company intends to accommodate such request; and

3.6.2 where relevant, change and re-issue such Construction Planning Assumptions accordingly.

3.7 A Transmission Owner may refer to the Authority as a Dispute in accordance with Section H, paragraph 4.1:

3.7.1 any notice received from The Company under 3.6.1; or

3.7.2 any failure by The Company to respond to a request made by such Transmission Owner under paragraph 3.5 within a reasonable period of time, taking into account the nature, complexity and urgency of the request.

3.8 Notwithstanding any request submitted by a Transmission Owner pursuant to paragraph 3.5 above, each Transmission Owner shall continue to take into account the Construction Planning Assumptions provided by The Company pursuant to sub-paragraph 2.2.3 (or deemed pursuant to paragraph 3.3), for the purposes of paragraph 4.3 of this Section D, Part Two, subject to any subsequent changes made to such Construction Planning Assumptions by The Company under paragraphs 3.4 or 3.6 or any determination of a Dispute referred to the Authority pursuant to paragraph 3.7.

3.9 For the avoidance of doubt, any change made to Construction Planning Assumptions pursuant to paragraphs 3.4 or 3.6 shall change the existing set of Construction Planning Assumptions and shall not constitute a separate set of Construction Planning Assumptions.

3.10 The Company shall act in accordance with Good Industry Practice in deciding whether to generate any set of Construction Planning Assumptions and, where relevant, in generating or modifying such Construction Planning Assumptions pursuant to this paragraph 3.

3.11 For the avoidance of doubt, where a User is undertaking OTSDUW, the extent of the Construction Planning Assumptions will depend upon the extent of the OTSDUW (and there will be no Construction Planning Assumptions provided to the nominated Offshore Transmission Owner whose Transmission System is to be delivered through OTSDUW Build).

4. TO CONSTRUCTION OFFERS

4.1 Each Transmission Owner which receives The Company Construction Application (other than an OTSDUW Build Application) shall notify The Company whether such Transmission

Owner intends to submit a TO Construction Offer in respect of the relevant Construction Project including, without limitation, where the Transmission Owner is not submitting a TO Construction Offer because to do so would be likely to involve the Transmission Owner:

- 4.1.1 to be in breach of its duties under section 9 of the Act; or
 - 4.1.2 to be in breach of any regulation made under section 29 of the Act or any other enactment relating to applicable safety standards; or.
 - 4.1.3 to incur costs equal to or in excess of 20 per cent of the original investment cost incurred by the offshore transmission owner in respect of the Offshore Transmission System, such amount to be cumulative over the lifetime of the transmission system.
- 4.2 A Transmission Owner shall give such notice as soon as reasonably practicable but, in any event, on or before the later of:
- 4.2.1 twenty-five calendar days less one Business Day after The Company Application Date; and
 - 4.2.2 twenty-three calendar days less one Business Day after the Construction Assumptions Date.
- 4.3 Where a Transmission Owner does not require Transmission Construction Works to be undertaken in respect of a Construction Project or where it otherwise notifies The Company under paragraph 4.1 that it will not be submitting a TO Construction Offer, it shall
- 4.3.1 at the same time as it provides notice pursuant to paragraph 4.1, also notify The Company of any technical design or operational criteria which the Transmission Owner intends, in planning and developing its Transmission System, to assume will apply to User Equipment at the Relevant Connection Site, Transmission Owner equipment at a Transmission Interface Site or Embedded Transmission Counterparty Equipment at an Embedded Transmission Interface Site;
 - 4.3.2 otherwise not (subject to any contrary determination of a Dispute referred to the Authority under paragraph 4.3) submit a TO Construction Offer to The Company in relation to such Construction Project.
- 4.3A In response to an OTSDUW Build Application, the nominated Offshore Transmission Owner shall not submit a TO Construction Offer to The Company in relation to such Construction Project, and shall instead submit a OTSDUW Completion Report to The Company in relation to such Construction Project (or, in the case of Phased OTSDUW Build, each phase of the Construction Project).
- 4.4 The Company may refer as a Dispute to the Authority in accordance with Section H, paragraph 4.1, any notice it receives:
- 4.4.1 under paragraph 4.1 that a Transmission Owner does not intend to submit a TO Construction Offer in relation to a Construction Project; or

- 4.4.2 under sub-paragraph 4.3.1 of any assumptions which a Transmission Owner intends to make in relation to User Equipment at a Relevant Connection Site.
- 4.5 A Transmission Owner shall prepare each TO Construction Offer so that, if the Construction Project to which it relates is constructed, such Transmission Owner would continue to comply with the obligations in respect of the planning and development of its Transmission System set out in Part One, paragraph 2.2 of this Section D by giving effect to such TO Construction Offer, except that:
- 4.5.1 for the purpose of Part One, paragraph 2.2, such Transmission Owner shall take into account Construction Planning Assumptions provided to it under paragraph 3 (as modified or updated pursuant to paragraphs 3.4 or 3.6) in respect of the Construction Project in the place of any other Planning Assumptions;
- 4.5.2 the technical design and operational criteria for the Relevant Connection Site shall be as set out in The Company Construction Application together with any site-specific information relating to the relevant Connection Site set out in the TO Construction Offer;
- 4.5.3 the technical design and operational criteria for any Transmission Interface Site or Embedded Transmission Interface Site shall be as set out in The Company Construction Application together with any site-specific information relating to the Transmission Interface Site or Embedded Transmission Interface Site set out in the TO Construction Offer; and
- 4.5.4 such Transmission Owner shall take into account any OTSDUW set out in The Company Construction Application.
- 4.5A A Transmission Owner shall prepare each OTSDUW Completion Report so that it reflects the information set out in the OTSDUW Build Application as such information may be updated by The Company in accordance with paragraph 18.4.
- 4.6 A TO Construction Offer may, where it is necessary for the relevant Transmission Owner to carry out additional extensive system studies to evaluate more fully the impact of a proposed Construction Project, indicate the areas that require more detailed analysis. Before such additional studies are required, The Company shall indicate whether it wishes the Transmission Owner to undertake the work necessary to proceed to make a revised TO Construction Offer within the period specified in paragraph 4 or, where relevant, any other timescale directed or consented to by the Authority.
- 4.7 The Company shall provide Detailed Planning Data to a Transmission Owner, where reasonably requested by such Transmission Owner, to enable it to carry out any detailed system studies referred to in paragraph 4.6, provided that such Transmission Owner can reasonably demonstrate that such provision is relevant and necessary.
- 4.8 Subject to paragraph 4.3, a Transmission Owner which receives an effective The Company Construction Application (other than an OTSDUW Build Application) under paragraph 2.2 above shall, unless otherwise agreed with The Company or determined or directed by the

Authority, submit a TO Construction Offer to The Company as soon as reasonably practicable and, in any event, on or before the later of:

4.8.1 two months plus fourteen calendar days after The Company Application Date; and

4.8.2 where relevant, two months plus twelve calendar days after the Construction Assumptions Date,

and, in the case of an OTSDUW Build Application, shall submit an OTSDUW Completion Report to The Company 6 months prior to the proposed OTSUA Transfer Time, or such other date as the Offshore Transmission Owner and The Company shall agree, and, in any event, by the OTSUA Transfer Time.

4.9 The Company and a Transmission Owner may agree that the Transmission Owner may submit its TO Construction Offer otherwise than in accordance with the dates set out in paragraph 4.8 provided that:

4.9.1 a TO Construction Offer to which sub-paragraph 4.8.1 applies shall be submitted not later than two months plus twenty-one calendar days after The Company Application Date; and

4.9.2 a TO Construction Offer to which sub-paragraph 4.8.2 applies shall be submitted not later than two months plus nineteen calendar days after the Construction Assumptions Date,

unless otherwise determined by the Authority in accordance with an application under Standard Condition C9 of The Company's Transmission Licence.

4.10 In the event that The Company modifies Construction Planning Assumptions after a Transmission Owner has submitted its TO Construction Offer for the Construction Project to which such Construction Planning Assumptions apply, the Transmission Owner shall revise and re-submit its TO Construction Offer to The Company, taking into account such modified Construction Planning Assumptions, as soon as reasonably practicable.

4.11 In the event that an application is made to the Authority under Standard Condition C9 of The Company's Transmission Licence concerning a Relevant Connection Site, the Transmission Owner shall revise and re-submit its TO Construction Offer relating to such Relevant Connection Site to The Company, taking into account any determination or other direction from the Authority.

4.12 For the avoidance of doubt, the revision of a TO Construction Offer under paragraph 4.6 varies the existing TO Construction Offer and will not constitute a new TO Construction Offer nor affect the time for which such existing TO Construction Offer remains open for acceptance pursuant to paragraph 5.1.

5. ACCEPTANCE OF TO CONSTRUCTION OFFERS BY THE COMPANY

- 5.1 A TO Construction Offer shall remain open for acceptance from the date on which it is submitted to The Company pursuant to paragraph 4 to a date not less than seven months from The Company Application Date unless an application is made to the Authority under Standard Condition C9 of The Company's Transmission Licence. In which event, such period shall remain open for acceptance until the date 17 days after any determination by or other direction from the Authority pursuant to such application.
- 5.2 A Party may refer any dispute in connection with a TO Construction Offer as a Dispute to the Authority in accordance with Section H, paragraph 4.1. A Party may refer any dispute in connection with an OTSDUW Completion Report (and any information submitted thereunder) and whether it is validly submitted in accordance with paragraph 4.5A as a Dispute to the Authority in accordance with Section H, paragraph 4.1.
- 5.3 If The Company wishes to accept a TO Construction Offer, it shall do so by promptly notifying the relevant Transmission Owner in the form specified in such TO Construction Offer and by providing such Transmission Owner with an executed copy of the relevant TO Construction Agreement. Following notification of such acceptance, the Transmission Owner shall construct the relevant parts of the Construction Project in accordance with this Code and the executed TO Construction Agreement.

6. GENERAL PROVISIONS CONCERNING THE DEVELOPMENT OF TO CONSTRUCTION OFFERS

- 6.1 The Construction Parties shall, in respect of each Construction Project:
- 6.1.1 agree a joint timetable, subject to and in accordance with the dates set out in paragraph 4 of this Section D, Part Two, for the development of co-ordinated TO Construction Offers and, in the case of The Company, any other planning or analysis required in the course of preparing The Company Offer;
- 6.1.2 co-operate and assist each other in order that TO Construction Offers, plans or analysis prepared by The Company and any application(s) for Consent(s) which are or are likely to be required in respect of the Construction Project, are co-ordinated;
- 6.1.3 provide each other with information about, in the case of a Transmission Owner as provider, the contents of its TO Construction Offer and, in the case of The Company as provider, any information about its relevant planning or analysis, to the extent that such information may materially affect such other Construction Party's TO Construction Offer or, in the case where such other Construction Party is The Company, its relevant planning or analysis;
- 6.1.4 exchange additional detailed information which cannot otherwise be derived from the Construction Planning Assumptions (for example, Voltage Waveform Quality Assessment) about, in the case of a Transmission Owner as provider, the contents of its TO Construction Offer and, in the case of The Company as provider, any information about its relevant planning or analysis, to the extent that such information is required for another Construction Party to ensure compliance with the criteria set out in Section D Part One Paragraph 2.2.6; and

- 6.1.5 where the Construction Project relates to the connection or modification of a connection to an Onshore Distribution System of an Offshore Transmission Owners Transmission System cooperate and assist each other in order that The Company can enter into and comply with the Embedded Transmission Bilateral Agreement.
- 6.2 In addition to any Construction Planning Assumptions provided in accordance with paragraph 3 of this Section D, Part Two, The Company shall keep each other Construction Party reasonably informed of the likelihood of, and provide information in relation to, any potential circumstances which, if they occurred, might reasonably be expected to change the Construction Planning Assumptions or otherwise materially affect the preparation of relevant TO Construction Offers including, without limitation, information in relation to any other potential New Connections or Modifications.
- 6.3 If a Transmission Owner which receives additional information pursuant to paragraph 6.2 reasonably identifies that such information, if incorporated into any Construction Planning Assumptions, would be likely to affect its TO Construction Offer, such Transmission Owner shall promptly notify The Company that its TO Construction Offer would be likely to be so affected.

7. GENERAL PROVISIONS CONCERNING NEW CONNECTIONS AND MODIFICATIONS

- 7.1 Subject to the payment of its Reasonable Charges, if any, as provided for in this paragraph 7.1, each Party shall provide all advice and assistance reasonably requested by another Party to enable it adequately to assess the implications (including the feasibility):
- 7.1.1 of making a Modification to User Equipment, a User's System, or any OTSUA or OTSDUW (whether such Modification is the result of Planned Works proposed by the Party requesting advice or assistance or at the request of a User);
- 7.1.2 of constructing a New Connection Site (including adequately assessing the feasibility of making any The Company Connection Application or considering the terms of any TO Construction Offer); or
- 7.1.3 in the case of a New Connection Site located Offshore, of a material change to the Construction Planning Assumptions concerning the proposed design of the Offshore Transmission System upon which an accepted TO Construction Offer was based.
- 7.2 If a proposed Modification referred to in paragraph 7.1 is the result of Planned Works proposed by the Party which has received a request for advice or assistance, that Party shall provide such advice and assistance free of charge. If a Modification referred to in paragraph 7.1 is or may be proposed by the Party requesting advice or assistance, or a User, or if the advice and assistance is in respect of a New Connection Site, the Party may charge The Company Reasonable Charges for such advice and assistance.
- 7.3 When giving advice and assistance pursuant to paragraph 7.1, each Party shall comply with Good Industry Practice.

8. OFFSHORE TRANSMISSION CONSTRUCTION SECURITIES

8.1 Each Offshore Transmission Owner shall provide security equivalent to the Offshore Construction Secured Amount in respect of its TO Construction Agreement in the form of:

8.1.1 in the case of an Offshore Transmission Owner which meets The Company Credit Rating Requirement at the date of the TO Construction Agreement, in accordance with Paragraph 8.2; and

8.1.2 in the case of an Offshore Transmission Owner which does not meet The Company Credit Rating Requirement at the date of the TO Construction Agreement or thereafter ceases to meet it, in accordance with Paragraph 8.3.

8.2 Provision Of Offshore Construction Securities Where The Transmission Owner Meets Credit Rating

8.2.1 Each Offshore Transmission Owner shall, as soon as possible after entering into a TO Construction Connection Agreement and in any event no later than one month after such date, confirm to The Company the position on whether it meets The Company Credit Rating Requirement. Thereafter not less than 75 days before 1 April and 1 October in each year the Offshore Transmission Owner shall confirm its The Company Credit Rating Requirement position to The Company (which in the case of a long term private credit rating shall be confirmed by Standard and Poor's or Moody's within a period of 45 days prior to the date of confirmation). The Offshore Transmission Owner shall inform The Company in writing forthwith if it becomes aware it does not meet The Company Credit Rating Requirement or if it is or is likely to be put on credit watch or any similar credit surveillance procedure which may give The Company reasonable cause to believe that the Offshore Transmission Owner may not be able to sustain its Credit Rating for at least 6 months.

8.2.2 In the event that the Offshore Transmission Owner has elected to provide The Company with an indicative credit rating and The Company is of the reasonable opinion that the Offshore Transmission Owner has ceased to comply with the requirements of Paragraph 8.2.1 then The Company may require the Offshore Transmission Owner forthwith:-

8.2.2.1 to apply to Standards and Poor's and/or Moody's for a further indicative long term private credit rating; or

8.2.2.2 to confirm to The Company that it shall provide the security referred to in Paragraph 8.2.4.

8.2.3 In the event of the Offshore Transmission Owner:-

8.2.3.1 not meeting The Company Credit Rating Requirement; or

8.2.3.2 having a credit rating below The Company Credit Rating Requirement; or

8.2.3.3 not having obtained from Standard and Poor's or Moody's within 30 days of the written notification under Paragraph 8.3.2 above an indicative long term private credit rating,

or if The Company becomes aware that:

8.2.3.4 the Offshore Transmission Owner ceases to meet The Company Credit Rating Requirement; or

8.2.3.5 the Offshore Transmission Owner is put on credit watch or other similar credit surveillance procedure as specified above which may give The Company reasonable cause to believe that the Offshore Transmission Owner may not be able to maintain an The Company Credit Rating Requirement for at least 6 months; or

8.2.3.6 the Offshore Transmission Owner has not obtained from Standard and Poor's or Moody's within 30 days of the written notification by The Company under Paragraph 8.2.2 above a further indicative long term private credit rating,

the Offshore Transmission Owner shall (where appropriate on receipt of written notification from The Company) comply with the terms of Paragraph 8.2.4.

8.2.4 The Offshore Transmission Owner shall within 21 days of the giving of a notice under Paragraph 8.2.3 or within 30 days of the Offshore Transmission Owner confirming to The Company under Paragraph 8.2.2 that it will provide the security specified in Paragraph 8.3.2 (whichever is the earlier), provide The Company with the security specified below to cover the Offshore Construction Secured Amount.

8.2.5 Until the facts or circumstances giving rise to the obligations of the Offshore Transmission Owner to provide the security have ceased then the provisions of Paragraph 8.3 shall apply.

8.2.6 In the event of The Company's credit requirements being reviewed at any time The Company shall advise the Offshore Transmission Owner in writing of the new credit requirements and if acceptable to the Offshore Transmission Owner the security arrangements will be amended accordingly.

8.2.7 In the event that the facts or circumstances giving rise to the obligations of the Offshore Transmission Owner to provide the security have ceased, then The Company shall release the security.

8.3 Provision Of Offshore Construction Securities Where Offshore Transmission Owner Does Not Meet Credit Rating

8.3.1 Each Offshore Transmission Owner hereby agrees that it shall at the date of the relevant TO Construction Agreement provide to The Company or procure the provision to The Company of, and the Offshore Transmission Owner shall at all times thereafter (unless and until the TO Construction Agreement shall be

terminated and all sums due or which will or might fall due in respect of which security is to be provided shall have been paid) maintain or procure that there is maintained in full force and effect (including by renewal or replacement), a security arrangement of a type specified in Paragraph 8.3.2 from time to time and for the time being to provide security for the Offshore Transmission Owner's obligation to pay the Offshore Construction Secured Amount.

8.3.2 Security can be provided by:

8.3.2.1 A Performance Bond or Letter of Credit from a Qualified Bank for the Offshore Construction Secured Amount, such Performance Bond or Letter of Credit to be Valid for at least the period up to and including the Offshore Construction Completed Date and to be renewed periodically where applicable in the manner stated in Paragraph 8.3.3.3; or

8.3.2.2 A cash deposit in a Bank Account at least for the Offshore Construction Secured Amount, such cash deposit to be increased or reduced periodically where applicable in the manner stated in Paragraph 8.3.3.4; or

8.3.2.3 A Performance Bond from a Qualified Company for the Offshore Construction Secured Amount, such Performance Bond to be Valid for at least the period stated in such Secured Amount Statement and to be renewed periodically where applicable in the manner stated in Paragraph 8.3.3.3.

8.3.3 General Provisions

8.3.3.1 Any Notice of Drawing to be delivered to Barclays Bank PLC or any other bank at which the Bank Account shall have been opened or a Qualified Bank or a Qualified Company may be delivered by hand, by post or by facsimile transmission.

8.3.3.2 If the Offshore Transmission Owner becomes aware that the bank issuing the Performance Bond or Letter of Credit ceases to be a Qualified Bank or that The Company giving the Performance Bond ceases to be a Qualified Company, the Offshore Transmission Owner shall notify The Company in writing as soon as it becomes so aware. If The Company becomes aware that the bank issuing the Performance Bond or Letter of Credit ceases to be a Qualified Bank or that The Company giving the Performance Bond ceases to be a Qualified Company, The Company may notify the Offshore Transmission Owner to that effect in writing. Where the bank or The Company ceases to be either a Qualified Bank or a Qualified Company (as the case may be) as a consequence of The Company having reasonable cause to doubt the continued rating of the said bank or company, such notice shall be accompanied by a statement setting out The Company's reasons for having such doubt. The Offshore Transmission Owner shall within 21 days of the giving of such notice by The Company or the Offshore

Transmission Owner whichever is the earlier provide a replacement Performance Bond and/or Letter of Credit from a Qualified Bank or Qualified Company, as the case may be, and/or provide a cash deposit of the required amount in a Bank Account. From the date the replacement Performance Bond or Letter of Credit or Bank Account cash deposit is effectively and unconditionally provided and Valid, The Company will consent in writing to the security which it replaces being released.

8.3.3.3 The following provisions shall govern the issuance, renewal and release of the Performance Bond or Letter of Credit:-

- a) The Performance Bond or Letter of Credit shall be Valid initially from the date required in accordance with Paragraph 8.2.4 or 8.3.1 respectively at least to and including the following 31st March or 30th September whichever is the earlier date. Such Performance Bond or Letter of Credit shall be for an amount not less than the Offshore Construction Secured Amount.
- b) On a date which is at least 45 days (or if such day is not a Business Day then on the immediately preceding Business Day) before the next following 31st March or 30th September whichever is the earlier date such Performance Bond or Letter of Credit shall be renewed so as to be Valid for not less than 6 months commencing from the immediately following 1st April or 1st October (as the case may be). Such renewed Performance Bond or Letter of Credit shall be for an amount not less than the Offshore Construction Secured Amount during the period that such renewed Performance Bond or Letter of Credit shall be Valid.
- c) Thereafter, the renewed Performance Bond or Letter of Credit shall be further renewed in like manner every 6 months.

8.3.3.4 The following provisions shall govern the maintenance of cash deposits in the Bank Account:

- a) The amount of the cash deposit to be maintained in the Bank Account shall be maintained from the date required in accordance with Paragraph 8.2.4 or 8.3.1 respectively at least to and including the following 31st March or 30th September, whichever is the earlier date. Such cash deposit shall be the Offshore Construction Secured Amount.
- b) Any interest accruing to the Bank Account shall be for the account of and belong to the Offshore Transmission Owner absolutely, and The Company agrees to take any steps required to be taken by it for the release from the Bank Account and payment to the Offshore Transmission Owner of such interest as soon as the same shall

have been credited to the Bank Account and The Company shall have received notice of such credit.

8.3.3.5 Notwithstanding any provision aforesaid:

- a) The Offshore Transmission Owner may provide different securities to The Company at any one time, each securing a different amount, provided that the aggregate amount secured by such securities shall be not less than the Offshore Construction Secured Amount.
- b) The Offshore Transmission Owner may upon the expiry of at least 14 days prior written notice to The Company, substitute one type of security for another provided that unless The Company shall otherwise agree in writing such substituted security must be Valid from 1st April or 1st October (as the case may be) and committed at least 45 days before the immediately preceding 31st March or 30th September (as the case may be) in the following manner:-
 - i) where a Performance Bond or a Letter of Credit is to substitute for other securities, it must be issued or given at least 45 days before such immediately preceding 31st March or 30th September (as the case may be).
 - ii) where a cash deposit in a Bank Account is to substitute for other securities, it must be deposited into the Bank Account at least 45 days before such immediately preceding 31st March or 30th September (as the case may be).
- c) Upon request by the Offshore Transmission Owner to The Company, securities substituted in the aforesaid manner shall, providing the substitute security shall be Valid, be released on the following 1st April or 1st October (as the case may be).

9 COORDINATION OF CONSTRUCTION PROJECTS

9.1 Where a Construction Project involves Works being undertaken by more than one Party, each Transmission Owner which is party to a TO Construction Agreement in respect of the Construction Project and The Company (together referred to as "**Joint Project Parties**") shall throughout the construction and commissioning of the Construction Project:

- 9.1.1 co-operate and assist each other in the development of co-ordinated TO Construction Programmes and, in the case of The Company, any other planning or analysis it undertakes in respect of the Construction Project;

- 9.1.2 provide each other from time to time with relevant information to the extent that such information may materially affect the Works of such other Joint Project Parties;
 - 9.1.3 meet from time to time, if so requested by another Joint Project Party, to agree arrangements to facilitate such development; and
 - 9.1.4 otherwise develop their TO Construction Programmes or, in the case of The Company, any other relevant planning or analysis, taking into account, to the extent that it is reasonable and practicable to do so, the activities and requirements of each other Joint Project Party.
- 9.2 Without limitation to paragraph 8.1, the Joint Project Parties shall liaise throughout the construction and commissioning of a Construction Project and each shall provide to each other Joint Project Party all information relating to its own Works and, in the case of The Company, User Works and/or OTSDUW, reasonably necessary to assist each other Joint Project Party in the performance of that other's part of the Works, and shall use all reasonable endeavours to co-ordinate and integrate their respective part of the Works. There may be meetings between representatives of the Joint Project Parties and/or the User at intervals to be agreed between the Joint Project Parties and/or the User (as appropriate). Unless otherwise agreed each Joint Project Party shall deliver to each other Joint Project Party a written report of its progress during each Calendar Quarter within seven days of the end of that Calendar Quarter.
- 9.3 Where a Construction Project involves the connection of Transmission System by an Offshore Transmission Owner to an Onshore Distribution System then the Transmission Owners shall in addition provide such assistance and information to The Company as The Company shall reasonably require in order to fulfil its obligations to the Embedded Transmission Counterparty under the Embedded Transmission Bilateral Agreement and to coordinate to the extent necessary the Construction Project with any works required on the Distribution System.
- 9.4 Where a Construction Project involves the connection of an Offshore Transmission System delivered by OTSDUW Build to an Onshore Transmission System then the Transmission Owners shall in addition provide such assistance and information to The Company as The Company shall reasonably require in order to fulfil its obligations to the User under the CUSC Contract with that User and to coordinate to the extent necessary the Construction Project with the OTSDUW Build.

10. COMMUNICATIONS PLANT

- 10.1 The Company and a Transmission Owner which is constructing a New Connection Site shall agree the Communications Plant to be provided and installed by the Transmission Owner and this may include, without limitation, Communications Plant to facilitate communications between the relevant User and The Company. Any failure to agree may be referred as a Dispute to the Authority in accordance with Section H, paragraph 4.1.

11. CONNECTION SITE RULES

- 11.1 Prior to the Completion Date under a TO Construction Agreement, the following shall be submitted pursuant to the terms of the TO Construction Agreement (or, in the case of OTSDUW Build, the following shall be submitted 6 months prior to the proposed OTSUA Transfer Time or such later date as the relevant parties shall agree between them and in any event by the OTSUA Transfer Time):
- 11.1.1 copies of the Safety Rules applicable at the relevant Transmission Owner Sites or User Sites which will be used at the User/Transmission Owner interface (including, in the case of OTSDUW Phased Build, any interface at the Interface Site), as followed and forwarded in accordance with the criteria set out in Section G, subparagraphs 2.2.7 to 2.2.10; and
 - 11.1.2 notice in writing from a Transmission Owner submitted directly to the relevant User as directed by The Company, notifying The Company when it has done so, of its Safety Coordinators, which notice shall be updated and resubmitted by the Transmission Owner whenever there is a change to the identity of its Safety Coordinators or to the Connection Points; and
 - 11.1.3 written confirmation from a Transmission Owner submitted directly to the relevant User as directed by The Company, notifying The Company when it has done so, that the Safety Coordinators acting on behalf of such Transmission Owner are authorised and competent pursuant to the requirements of the relevant appendix of OC8; and
 - 11.1.4 written notice from a Transmission Owner submitted directly to The Company notifying The Company of a list of the managers who have been duly authorised to sign Site Responsibility Schedules on behalf of the Transmission Owner; and
 - 11.1.5 written notice from a User, as procured by The Company and submitted directly by the User to the relevant Transmission Owner of:
 - 11.1.5.1 the User's Safety Co-ordinators, which notice shall be updated yearly and whenever there is a change to the identity of the User's Safety Coordinators or to the Connection Points;
 - 11.1.5.2 a list of persons appointed by the User to undertake operational duties on the User's System and to issue and receive operational messages and instructions in relation to the User's System; and
 - 11.1.5.3 an appointed person or persons responsible for the maintenance and testing of User's Plant and Apparatus;
 - 11.1.6 a list of the User's managers who have been duly authorised to sign Site Responsibility Schedules on behalf of the User as procured by The Company and submitted by The Company to the relevant Transmission Owner; and
 - 11.1.7 written confirmation from a User, as procured by The Company and submitted directly by the User to the relevant Transmission Owner, that the Safety Co-

ordinators acting on behalf of such User are authorised and competent pursuant to the requirements of the relevant appendix of OC8.

12. TRANSMISSION INTERFACE SITE RULES

12.1 Prior to the Completion Date under a TO Construction Agreement (or, in the case of OTSDUW Build, 6 months prior to the proposed OTSUA Transfer Time or such later date as the relevant parties shall agree between them and in any event by the OTSUA Transfer Time), the following shall be submitted by each Transmission Interface Site Party directly to the other relevant Transmission Interface Site Party or Parties and to The Company:

12.1.1 a copy of the Transmission Interface Site Party's Safety Rules applicable at the relevant Transmission Interface Site;

12.1.2 notice in writing of its Safety Coordinators, which notice shall be updated and resubmitted by the Transmission Interface Site Party whenever there is a change to the identity of its Safety Coordinators or to the Transmission Interface Site;

12.1.3 written confirmation that the Safety Coordinators acting on behalf of the Transmission Interface Site Party are authorised and competent pursuant to the requirements of the relevant appendix of OC8; and

12.1.4 written notice of a list of the managers who have been duly authorised to sign Site Responsibility Schedules on behalf of the Transmission Interface Site Party.

13. EMBEDDED TRANSMISSION INTERFACE SITE RULES

13.1 Prior to the Completion Date under a TO Construction Agreement, the following shall be submitted pursuant to the terms of the TO Construction Agreement:

13.1.1 copies of the Safety Rules applicable at the relevant Transmission Owner Sites or Embedded Transmission Counterparty Sites which will be used at the Embedded Transmission Counterparty/Transmission Owner interface, as followed and forwarded in accordance with the criteria set out in Section G, sub-paragraphs 2.2.7 to 2.2.10; and

13.1.2 notice in writing from a Transmission Owner submitted directly to the relevant Embedded Transmission Counterparty as directed by The Company, notifying The Company when it has done so, of its Safety Coordinators, which notice shall be updated and resubmitted by the Transmission Owner whenever there is a change to the identity of its Safety Coordinators or to the Connection Points; and

13.1.3 written confirmation from a Transmission Owner submitted directly to the relevant Embedded Transmission Counterparty as directed by The Company, notifying The Company when it has done so, that the Safety Coordinators acting on behalf of such Transmission Owner are authorised and competent pursuant to the requirements of the relevant appendix of OC8; and

- 13.1.4 written notice from a Transmission Owner submitted directly to The Company notifying The Company of a list of the managers who have been duly authorised to sign Site Responsibility Schedules on behalf of the Transmission Owner; and
- 13.1.5 written notice from an Embedded Transmission Counterparty as procured by The Company and submitted directly by the User to the relevant Transmission Owner of:
 - 13.1.5.1 the Embedded Transmission Counterparty's Safety Co-ordinators, which notice shall be updated yearly and whenever there is a change to the identity of the Embedded Transmission Counterparty's Safety Coordinators or to the Connection Points;
 - 13.1.5.2 a list of persons appointed by the Embedded Transmission Counterparty's to undertake operational duties on the Embedded Transmission Counterparty's System and to issue and receive operational messages and instructions in relation to the Embedded Transmission Counterparty's System; and
 - 13.1.5.3 an appointed person or persons responsible for the maintenance and testing of Embedded Transmission Counterparty's Plant and Apparatus;
- 13.1.6 a list of the Embedded Transmission Counterparty's managers who have been duly authorised to sign Site Responsibility Schedules on behalf of the Embedded Transmission Counterparty as procured by The Company and submitted by The Company to the relevant Transmission Owner; and
- 13.1.7 written confirmation from an Embedded Transmission Counterparty, as procured by The Company and submitted directly by the Embedded Transmission Counterparty to the relevant Transmission Owner, that the Safety Co-ordinators acting on behalf of such Embedded Transmission Counterparty are authorised and competent pursuant to the requirements of the relevant appendix of OC8.

14. SITE SPECIFICATIONS

- 14.1 Prior to the provision of an Agreement for Energisation or Agreement for an Interim Operational Notification from a Transmission Owner, the Transmission Owner shall provide to The Company a new or revised Connection Site Specification as described in Section D, Part One, sub-paragraph 2.6.1 that reflects the information contained in the relevant TO Construction Agreement(s) .
- 14.2 Prior to the to the Completion Date under an Offshore Construction Agreement, the Offshore Transmission Owner shall provide to any relevant Transmission Interface Site Party and to The Company a new or revised Transmission Interface Site Specification as described in Section D, Part One, sub-paragraph 2.7.1 that reflects the information contained in the relevant TO Construction Agreement(s).
- 14.3 Prior to the provision of an Agreement for Energisation or Agreement for an Interim Operational Notification from an Embedded Transmission Counterparty, the Transmission

Owner shall provide to The Company a new or revised Embedded Transmission Site Specification as described in Section D, Part One, sub-paragraph 2.6.1 that reflects the information contained in the relevant TO Construction Agreement(s).

- 14.4 In the case of OTSDUW Build, 6 months prior to the proposed OTSUA Transfer Time, or such other date as the Offshore Transmission Owner and The Company shall agree, and in any event by the OTSUA Transfer Time, the Offshore Transmission Owner shall provide to The Company a new (or, in the case of OTSDUW Phased Build, a revised) Connection Site Specification as described in Section D, Part One, sub-paragraph 2.6.1 that reflects the information contained in the relevant OTSDUW Build Application (as such information may be updated by The Company in accordance with paragraph 18.4).
- 14.5 In the case of OTSDUW Build, 6 months prior to the proposed OTSUA Transfer Time, or such other date as the Offshore Transmission Owner and The Company shall agree, and in any event by the OTSUA Transfer Time, the Offshore Transmission Owner shall provide to The Company a new (or, in the case of OTSDUW Phased Build, a revised) Transmission Interface Site Specification as described in Section D, Part One, sub-paragraph 2.7.1 that reflects the information contained in the relevant OTSDUW Build Application (as such information may be updated by The Company in accordance with paragraph 18.4).
- 14.6 In the case of OTSDUW Build, 6 months prior to the proposed OTSUA Transfer Time, or such other date as the Offshore Transmission Owner and The Company shall agree, and in any event by the OTSUA Transfer Time, the Offshore Transmission Owner shall provide to The Company a new (or, in the case of OTSDUW Phased Build, a revised) Services Capability Specification as described in Section C, Part One, sub-paragraph 3.1.1 that reflects the information contained in the relevant OTSDUW Build Application (as such information may be updated by The Company in accordance with paragraph 18.4).
- 14.7 In the event the Offshore Transmission Owner reasonably believes the information contained in the relevant OTSDUW Build Application (or any updates to this provided by The Company) means it will be unable to provide a Connection Site Specification, Transmission Interface Site Specification or Services Capability Specification in accordance with Clauses 14.4, 14.5 and/or 14.6 it shall notify The Company immediately.

15. SITE RESPONSIBILITY SCHEDULES

- 15.1 In order to inform site operational staff of agreed responsibilities for Plant and/or Apparatus at an operational interface:
 - 15.1.1 In the case of a Connection Site, a Site Responsibility Schedule shall be produced for a Connection Site by the Transmission Owner whose Transmission System is connected to such Connection Site and The Company shall provide such Transmission Owner with the information required to enable the Transmission Owner to prepare such Site Responsibility Schedule.
 - 15.1.2 In the case of a Transmission Interface Site, a Site Responsibility Schedule shall be produced by the Onshore Transmission Owner whose Transmission System is

connected to such Transmission Interface Site and the relevant Transmission Interface Site Parties shall provide such Transmission Owner with the information required to enable the Onshore Transmission Owner to prepare such Site Responsibility Schedule. In the case of OTSDUW Build, The Company shall provide the relevant Offshore Transmission Owner with the information it is required to provide to the Onshore Transmission Owner under this paragraph 15.1.2.

- 15.1.3 In the case of an Embedded Transmission Interface Site, the Transmission Owner whose Transmission System is connected to such Embedded Transmission Interface Site will provide The Company with the information required to enable the relevant Embedded Transmission Counterparty to prepare such Site Responsibility Schedule.
- 15.2 A Transmission Owner shall forward a Site Responsibility Schedule prepared by it pursuant to paragraph 15.1.1 to The Company and agree any changes that may be required to such Site Responsibility Schedule with The Company. Upon finalisation of the Site Responsibility Schedule pursuant to this paragraph 15.2, the Transmission Owner shall forward a duly signed Site Responsibility Schedule to The Company and The Company shall promptly sign and procure signatures from the relevant User as required and forward such signed copy of the Site Responsibility Schedule back to the Transmission Owner.
- 15.3 An Onshore Transmission Owner shall forward a Site Responsibility Schedule prepared by it pursuant to paragraph 15.1.2 to both The Company and any other relevant Transmission Interface Site Parties and agree any changes that may be required to such Site Responsibility Schedule with The Company or the other relevant Transmission Interface Site Parties. Upon finalisation of the Site Responsibility Schedule pursuant to this paragraph 15.3 the Onshore Transmission Owner shall forward a duly signed Site Responsibility Schedule to both The Company and any relevant Transmission Interface Site Parties and both The Company and the other Transmission Interface Site Parties shall promptly sign and forward such signed copy of the Site Responsibility Schedule back to the Onshore Transmission Owner.
- 15.4 The Company shall forward a Site Responsibility Schedule prepared by the relevant Embedded Transmission Counterparty using the information provided under 15.1.3 to the relevant Offshore Transmission Owner and agree any request for changes that may be required to such Site Responsibility Schedule with the said Offshore Transmission Owner to be raised with the relevant Embedded Transmission Counterparty. Upon finalisation of the Site Responsibility Schedule pursuant to this paragraph 15.4, The Company shall forward a duly signed Site Responsibility Schedule to the relevant Offshore Transmission Owner and the relevant Offshore Transmission Owner shall promptly sign and forward such signed copy of the Site Responsibility Schedule back to The Company.
- 15.5 Each Site Responsibility Schedule must have recorded on it the Safety Rules which apply to each item of Plant and/or Apparatus in accordance with Section G, paragraph 2.2.
- 15.6 In carrying out their obligations under this paragraph 15, the Parties shall, and The Company shall procure that Users shall, comply with Appendix 1 of the Connection

Conditions as applicable to GB Code User's or Appendix E1 of the European Connection Conditions of the Grid Code as applicable to EU Code User's and (as amended from time to time).

16. ACCESS

- 16.1 The provisions relating to access to Transmission Owner's Sites by Users and to User's Sites by Transmission Owners, are set out in the Interface Agreement between such Transmission Owner and User.
- 16.2 The provisions relating to access to Transmission Interface Sites by other Transmission Owners, are set out in the Transmission Interface Agreement between such Transmission Owners.
- 16.3 The provisions relating to access to a Transmission Owner's Embedded Transmission Interface Site by an Embedded Transmission Counterparty and to an Embedded Transmission Counterparty's Site by a Transmission Owner may be set out in the Interface Agreement between such Transmission Owner and Embedded Transmission Counterparty and/or the bilateral agreement relating to the relevant Embedded Transmission Interface Site between The Company and the Embedded Transmission Counterparty.
- 16.4 In addition to the provisions relating to access referred to in paragraph 16.1, where a Transmission Owner Site contains exposed HV conductors, unaccompanied access will only be granted to individuals holding an Authority for Access issued by the Transmission Owner. The procedure for applying for authority for Access is contained in the Interface Agreement.
- 16.5 In the case of OTSDUW Phased Build, until the OTSUA Transfer Time of the last phase, the Transmission Owners at the Transmission Owner Sites at which the OTSDUW Phased Build is being taken, shall allow the User (and its employees, agents, suppliers, contractors and sub-contractors) necessary access to such site to enable the User to undertake the OTSDUW (but not so as to disrupt the operation of the Transmission Owner's Plant and Apparatus located thereon), such access to be in accordance with any reasonable regulations relating thereto made by the site owner or occupier.

17. DISCONNECTION AND REMOVAL OF TRANSMISSION CONNECTION ASSETS

- 17.1 The Company shall provide six months notice to a Transmission Owner of the date that The Company intends to permanently disconnect User Equipment which is connected to such Transmission Owner's Transmission System.

- 17.2 The Company may provide a Transmission Owner with more than six months notice of an intended permanent disconnection of User Equipment connected to such Transmission Owner's Transmission System only where The Company has obtained the prior consent of the relevant User to give such longer notice.
- 17.3 Where The Company permanently disconnects a User which was connected to a Transmission Owner's Transmission System:
- 17.3.1 The Company shall procure that such User removes any of the User Equipment on such Transmission Owner's land within six months of the date of disconnection under paragraph 17.1 or such longer period as may be agreed between the User and such Transmission Owner; and
- 17.3.2 such Transmission Owner shall remove any of the Transmission Owner Connection Assets on the land of the User concerned within six months of termination under paragraph 17.1 or such longer period as may be agreed between the User and such Transmission Owner.
- 17.4 Each Transmission Owner shall give, and The Company shall procure, that any relevant User gives, such rights to access land as are reasonably required in order to facilitate the removal of User Equipment and Transmission Owner Connection Assets pursuant to this paragraph 17.
- 17.5 The Company shall not be in breach of its obligation to provide notice pursuant to 17.1 to the extent that any failure or delay in giving notice to a Transmission Owner was caused by a failure or delay by the relevant User in providing notice to The Company under the CUSC.

18. PROCESS IN THE CASE OF OTSDUW BUILD

- 18.1 In the case of OTSDUW Build, the nominated Offshore Transmission Owner shall, as soon as reasonably practicable following its accession to this Code, advise The Company and any other relevant Transmission Licensee of the expected OTSUA Transfer Time, and shall advise The Company and any other relevant Transmission Licensee of any changes to that time as soon as it becomes aware of the same.
- 18.2 Until the OTSUA Transfer Time for the OTSUA, the OTSUA shall not be (or form part of) any Offshore Transmission System. With effect from the OTSUA Transfer Time, the OTSUA shall become an Offshore Transmission System, and the relevant Offshore Transmission System Owner shall ensure that it complies with this Code in respect of such Offshore Transmission System.
- 18.3 In the case of OTSDUW Phased Build, it is acknowledged that there will be separate OTSUA Transfer Times for each phase of the OTSDUW Build, and that the Plant and Apparatus in question will only form part of the relevant Offshore Transmission System Owner's Transmission System (and the relevant Offshore Transmission System Owner will

only be obliged to comply with this Code in respect of such Transmission System) with effect from the relevant OTSUA Transfer Time.

- 18.4 The Company will keep the nominated Offshore Transmission Owner updated with any amendments or revisions to the information provided in the OTSDUW Build Application required to finalise the Connection Site Specification, Services Capability Specification or Transmission Interface Site Specification as received by The Company from the User.

PART THREE: TEC EXCHANGE

1. TEC EXCHANGE PROCESS

- 1.1 If The Company considers it may be necessary, it shall submit a The Company TEC Exchange Rate Application in accordance with paragraph 1.21.2 to:

1.1.1 the Transmission Owner, if any, whose Transmission System is located at the Relevant Connection Site of the Increasing User or the Decreasing User;

1.1.2 any Transmission Owner in relation to whose Transmission System the Relevant Connection Site of the Increasing User or the Decreasing User satisfies the criteria set out in Schedule Four; and

1.1.3 any Transmission Owner which does not receive The Company TEC Exchange Rate Application pursuant to sub-paragraphs 1.1 or 1.2, but which:

1.1.3.1 otherwise receives TEC Exchange Planning Assumptions pursuant to paragraph 2.1 or 2.2 in relation to the Relevant Connection Site of the Increasing User or the Decreasing User; or

1.1.3.2 The Company otherwise identifies is likely to be required to calculate a TEC Exchange Rate in respect of the Exchange Rate Request,

(The Company and each Transmission Owner which receives The Company TEC Exchange Rate Application shall be referred to in this Section as a "**TEC Exchange Party**").

- 1.2 The Company shall submit The Company TEC Exchange Rate Application:

1.2.1 pursuant to sub-paragraphs 1.1.1 and 1.1.2, as soon as reasonably practicable, and in any event within three Business Days of the User Application Date in relation to such Relevant Connection Site of the Increasing User or the Decreasing User.

1.2.2 pursuant to sub-paragraph 1.1.3, at the same time as TEC Exchange Planning Assumptions are submitted to a Transmission Owner under paragraph 2.2 or, where applicable, at the same time as The Company gives a Transmission Owner notice under paragraph 2.3.

1.3 For the purposes of this Section D, Part Three, The Company TEC Exchange Rate Application shall be deemed to be effective if it is complete and clear in all material respects.

1.4 If a Transmission Owner reasonably considers that The Company TEC Exchange Rate Application is not effective it shall, as soon as reasonably practicable and in any event within five Business Days of receipt of The Company TEC Exchange Rate Application, notify The Company of:

1.4.1 the detailed reasons why it considers The Company TEC Exchange Rate Application is incomplete or unclear in a material respect; and

1.4.2 the amendments (including clarifications, additional information, data or other material) it considers are required to make The Company TEC Exchange Rate Application effective,

and shall otherwise use its best endeavours to liaise with and assist The Company (and, where reasonably requested by The Company, any relevant third parties) so that The Company TEC Exchange Rate Application is made effective as soon as reasonably practicable. Any dispute in relation to the effectiveness of The Company TEC Exchange Rate Application may be referred as a Dispute to the Authority in accordance with Section H, paragraph 4.1.

1.5 The Company shall immediately notify each other TEC Exchange Party following:

1.5.1 any change in The Company TEC Exchange Rate Application or associated information provided to such TEC Exchange Party; or

1.5.2 the withdrawal of the relevant User Application by a User, in which case such notice shall also constitute notice of withdrawal by The Company of any relevant The Company TEC Exchange Rate Application.

2. PROVISION OF TEC EXCHANGE PLANNING ASSUMPTIONS FOLLOWING THE COMPANY TEC EXCHANGE RATE APPLICATION

2.1 In addition to Planning Assumptions used for general transmission planning pursuant to Section D, Part One, paragraph 2.2, The Company may, as a consequence of a User Application for a TEC Exchange Rate Request, also generate a separate set of Planning Assumptions which take into account the power flows which The Company expects are likely to result from a TEC Trade for use by each Transmission Owner only in the preparation of a TO TEC Exchange Rate ("**TEC Exchange Planning Assumptions**").

2.2 If The Company generates TEC Exchange Planning Assumptions, it shall do so as soon as reasonably practicable and, in any event, within five Business Days of the User Application Date and shall:

2.2.1 immediately provide to each Transmission Owner such parts of the set of TEC Exchange Planning Assumptions as The Company reasonably determines are likely to materially affect such Transmission Owner's Transmission System; and

- 2.2.2 at the same time as TEC Exchange Planning Assumptions are provided to any Transmission Owner(s) pursuant to sub-paragraph 2.2.1, either:
 - 2.2.2.1 identify The Company TEC Exchange Rate Application already submitted to such Transmission Owner under sub-paragraphs 1.1.1 or 1.1.2 to which the TEC Exchange Planning Assumptions relate; or
 - 2.2.2.2 submit a new The Company TEC Exchange Rate Application to such Transmission Owner pursuant to sub-paragraph 1.1.3.
- 2.3 The Company shall notify each Transmission Owner which receives an The Company TEC Exchange Rate Application as soon as reasonably practicable and, in any event, within two Business Days of the User Application Date, if it does not intend to generate a set of TEC Exchange Planning Assumptions in respect of the relevant Exchange Rate Request. Following such notice The Company shall inform each Transmission Owner that receives The Company TEC Exchange Rate Application which previously notified Planning Assumptions should apply and such Planning Assumptions shall be deemed to also be TEC Exchange Planning Assumptions for the purposes of such The Company TEC Exchange Rate Application.
- 2.4 The Company may, in its discretion, change a set of TEC Exchange Planning Assumptions (including any deemed TEC Exchange Planning Assumptions under paragraph 2.3) by giving notice to the relevant Transmission Owner(s), at any time up to the date not less than three months after the User Application Date.
- 2.5 A Transmission Owner may submit a request to The Company for a change to TEC Exchange Planning Assumptions it has received pursuant to paragraphs 2.2 or 2.4 or which have been deemed pursuant to paragraph 2.3, provided that such request shall contain a description (in reasonable but not excessive detail) of the reason(s) for the request.
- 2.6 If The Company receives a request for a change to TEC Exchange Planning Assumptions pursuant to paragraph 2.5 it shall, as soon as reasonably practicable:
 - 2.6.1 notify the Transmission Owner submitting the request and any other Transmission Owner, which is likely to be materially affected by the requested change, whether or not and, where relevant, how The Company intends to accommodate such request; and
 - 2.6.2 where relevant, change and re-issue such TEC Exchange Planning Assumptions accordingly.
- 2.7 A Transmission Owner may refer to the Authority as a Dispute in accordance with Section H, paragraph 4.1:
 - 2.7.1 any notice received from The Company under 2.6.1; or
 - 2.7.2 any failure by The Company to respond to a request made by such Transmission Owner under paragraph 2.5 within a reasonable period of time, taking into account the nature, complexity and urgency of the request.

2.8 For the avoidance of doubt, any change made to TEC Exchange Planning Assumptions pursuant to paragraphs 2.4 or 2.6 shall change the existing set of TEC Exchange Planning Assumptions and shall not constitute a separate set of TEC Exchange Planning Assumptions.

2.9 The Company shall act in accordance with Good Industry Practice in deciding whether to generate any set of TEC Exchange Planning Assumptions and, where relevant, in generating or modifying such TEC Exchange Planning Assumptions pursuant to this paragraph 2.

3. TEC EXCHANGE RATES

3.1 A TO shall prepare each TO TEC Exchange Rate so that, if the TEC Trade to which it relates becomes effective, such Transmission Owner would continue to comply with the obligations in respect of the planning and development of its Transmission System set out in Part One, paragraph 2.2 of this Section D by giving effect to such The Company TEC Exchange Rate Application, except that:

3.1.1 for the purpose of Part One, paragraph 2.2, such Transmission Owner shall take into account TEC Exchange Planning Assumptions provided to it under paragraph 2 (as modified or updated pursuant to paragraphs 2.4 or 2.6) in respect of The Company TEC Exchange Rate Application in the place of any other Planning Assumptions.

3.2 A Transmission Owner which receives an effective The Company TEC Exchange Rate Application under paragraph 1.2 above shall, unless otherwise agreed with The Company or determined or directed by the Authority, submit a TO TEC Exchange Rate to The Company as soon as reasonably practicable and, in any event, on or before the later of:

3.2.1 three months less thirteen Business Days after the User Application Date; and

3.2.2 where relevant, three months less fifteen Business Days after the TEC Exchange Assumptions Date.

3.3 The Company and a Transmission Owner may agree that the Transmission Owner may submit its TO TEC Exchange Rate otherwise than in accordance with the dates set out in paragraph 3.2 provided that:

3.3.1 a TO TEC Exchange Rate to which sub-paragraph 3.2.1 applies shall be submitted not later than three months less five Business Days after the User Application Date; and

3.3.2 a TO TEC Exchange Rate to which sub-paragraph 3.2.2 applies shall be submitted not later than three months less seven Business Days after the TEC Exchange Assumptions Date,

unless otherwise directed by the Authority.

- 3.4 In the event that The Company modifies TEC Exchange Planning Assumptions after a Transmission Owner has submitted its TO TEC Exchange Rate for The Company TEC Exchange Rate Application to which such TEC Exchange Planning Assumptions apply, the Transmission Owner shall revise and re-submit its TO TEC Exchange Rate to The Company, taking into account such modified TEC Exchange Rate Planning Assumptions, as soon as reasonably practicable.

PART FOUR: STATEMENT OF WORKS

1. EVALUATION OF TRANSMISSION IMPACT (ETI)

- 1.1 If The Company considers it may be necessary, it shall submit The Company Request for a Statement of Works in accordance with paragraph 1.2 to:

1.1.1 the Transmission Owner, if any, whose Transmission System is located at the Relevant Connection Site;

1.1.2 any Transmission Owner in relation to whose Transmission System the Relevant Connection Site satisfies the criteria set out in Schedule Four; and

1.1.3 any Transmission Owner which does not receive The Company Request for a Statement of Works pursuant to sub-paragraphs 1.1.1 or 1.1.2, but which:

1.1.3.1 otherwise receives Statement of Works Planning Assumptions pursuant to paragraph 2.2 in relation to the Relevant Connection Site; or

1.1.3.2 The Company otherwise identifies is likely to be required to submit a TO Statement of Works Notice in respect of the Statement of Works Project,

(The Company and each Transmission Owner which receives The Company Request for a Statement of Works shall be referred to in this Section as a “**Statement of Works Party**”).

- 1.2 The Company shall submit The Company Request for a Statement of Works:

1.2.1 pursuant to sub-paragraphs 1.1.1 and 1.1.2, as soon as reasonably practicable, and in any event within three Business Days of the User Application Date in relation to such Relevant Connection Site; and

1.2.2 pursuant to sub-paragraph 1.1.3, at the same time as Statement of Works Planning Assumptions are submitted to a Transmission Owner under paragraph 2.2 or, where applicable, at the same time as The Company gives a Transmission Owner notice under paragraph 2.3.

- 1.3 For the purposes of this Section D, Part Four, The Company Request for a Statement of Works shall be deemed to be effective if it is complete and clear in all material respects.

1.4 If a Transmission Owner reasonably considers that The Company Request for a Statement of Works is not effective it shall, as soon as reasonably practicable and in any event within five Business Days of receipt of The Company Request for a Statement of Works, notify The Company of:

1.4.1 the detailed reasons why it considers The Company Request for a Statement of Works is incomplete or unclear in a material respect; and

1.4.2 the amendments (including clarifications, additional information, data or other material) it considers are required to make The Company Request for a Statement of Works effective,

and shall otherwise use its best endeavours to liaise with and assist The Company (and, where reasonably requested by The Company, any relevant third parties) so that The Company Request for a Statement of Works is made effective as soon as reasonably practicable. Any dispute in relation to the effectiveness of The Company Request for a Statement of Works may be referred as a Dispute to the Authority in accordance with Section H, paragraph 4.1.

1.5 Each Transmission Owner shall charge The Company and The Company shall pay Engineering Charges in relation to a The Company Request for a Statement of Works in accordance with Schedule Ten.

1.6 The Company shall immediately notify each other Statement of Works Party following:

1.6.1 any change in The Company Request for a Statement of Works or associated information provided to such Statement of Works Party; or

1.6.2 the withdrawal of the relevant User Application by a User, in which case such notice shall also constitute notice of a withdrawal by The Company of any relevant The Company Request for a Statement of Works.

2. PROVISION OF STATEMENT OF WORKS PLANNING ASSUMPTIONS FOLLOWING THE COMPANY REQUEST FOR A STATEMENT OF WORKS

2.1 In addition to Planning Assumptions used for general transmission planning pursuant to Section D, Part One, paragraph 2.2, The Company may, as a consequence of a User Application for a Request for a Statement of Works, also generate a separate set of Planning Assumptions which take into account the power flows which The Company expects are likely to result from the Statement of Works Project for use by each Transmission Owner only in the preparation of a TO Statement of Works Notice (“**Statement of Works Planning Assumptions**”).

2.2 If The Company generates Statement of Works Planning Assumptions, it shall do so as soon as reasonably practicable and, in any event, within five Business Days of the User Application Date and shall:

- 2.2.1 immediately provide to each Transmission Owner such parts of the set of Statement of Works Planning Assumptions as The Company reasonably determines are likely to materially affect such Transmission Owner's Transmission System; and
- 2.2.2 at the same time as Statement of Works Planning Assumptions are provided to any Transmission Owner(s) pursuant to sub-paragraph 2.2.1, either:
 - 2.2.2.1 identify The Company Request for a Statement of Works already submitted to such Transmission Owner under sub-paragraphs 1.1.1 or 1.1.2 to which the Statement of Works Planning Assumptions relate; or
 - 2.2.2.2 submit a new The Company Request for a Statement of Works to such Transmission Owner pursuant to sub-paragraph 1.1.3.
- 2.3 The Company shall notify each Transmission Owner which receives The Company Request for a Statement of Works as soon as reasonably practicable and, in any event, within two Business Days of the User Application Date, if it does not intend to generate a set of Statement of Works Planning Assumptions in respect of the relevant Statement of Works Project. Following such notice the general Planning Assumptions provided to Transmission Owners pursuant to Section D, Part One, paragraph 2.2 shall be deemed to also be Statement of Works Planning Assumptions for the purposes of such Statement of Works Project.
- 2.4 The Company may, in its discretion, change a set of Statement of Works Planning Assumptions (including any deemed Statement of Works Planning Assumptions under paragraph 2.3) by giving notice to the relevant Transmission Owner(s), at any time up to the submission by the Transmission Owner(s) of the TO Statement of Works to which such Statement of Works Planning Assumptions apply.
- 2.5 A Transmission Owner may submit a request to The Company for a change to Statement of Works Planning Assumptions it has received pursuant to paragraphs 2.2 or 2.4 or which have been deemed pursuant to paragraph 2.3, provided that such request shall contain a description (in reasonable but not excessive detail) of the reason(s) for the request.
- 2.6 If The Company receives a request for a change to Statement of Works Planning Assumptions pursuant to paragraph 2.5 it shall, as soon as reasonably practicable:
 - 2.6.1 notify the Transmission Owner submitting the request and any other Transmission Owner, which is likely to be materially affected by the requested change, whether or not and, where relevant, how The Company intends to accommodate such request; and
 - 2.6.2 where relevant, change and re-issue such Statement of Works Planning Assumptions accordingly.

- 2.7 A Transmission Owner may refer to the Authority as a Dispute in accordance with Section H, paragraph 4.1:
- 2.7.1 any notice received from The Company under 2.6.1; or
 - 2.7.2 any failure by The Company to respond to a request made by such Transmission Owner under paragraph 2.5 within a reasonable period of time, taking into account the nature, complexity and urgency of the request.
- 2.8 Notwithstanding any request submitted by a Transmission Owner pursuant to paragraph 2.5 above, each Transmission Owner shall continue to take account the Statement of Works Planning Assumptions provided by The Company pursuant to sub-paragraph 1.1.3 (or deemed pursuant to paragraph 2.3), for the purposes of paragraph 3.3 of this Section D, Part Four, subject to any subsequent changes made to such Statement of Works Planning Assumptions by The Company under paragraphs 2.4 or 2.6 or any determination of a Dispute referred to the Authority pursuant to paragraph 2.7.
- 2.9 For the avoidance of doubt, any change made to Statement of Works Planning Assumptions pursuant to paragraphs 2.4 or 2.6 shall change the existing set of Statement of Works Planning Assumptions and shall not constitute a separate set of Statement of Works Planning Assumptions.
- 2.10 The Company shall act in accordance with Good Industry Practice in deciding whether to generate any set of Statement of Works Planning Assumptions and, where relevant, in generating or modifying such Statement of Works Planning Assumptions pursuant to this paragraph 2.

3. TO STATEMENT OF WORKS NOTICE

- 3.1 Each Transmission Owner which receives The Company Request for a Statement of Works shall notify The Company in accordance with paragraph 3.2 whether or not such Transmission Owner requires Transmission Construction Works to be undertaken in respect of a Statement of Works Project (such notice to be referred to as a “**TO Statement of Works Notice**”). Where the TO Statement of Works Notice specifies that Transmission Construction Works are required, then, at any time within the period referred to at paragraph 3.6, The Company may submit to the Transmission Owner The Company Modification Application. Where the TO Statement of Works Notice specifies that Transmission Construction Works are not required it shall specify whether or not, in planning and developing its Transmission System, the Transmission Owner has assumed that any technical design or operational criteria will apply to User Equipment at the Relevant Connection Site, and details of what such criteria are.
- 3.2 A Transmission Owner shall submit a TO Statement of Works Notice as soon as reasonably practicable but, in any event, on or before the later of:
- 3.2.1 twenty-five calendar days less one Business Day after The Company Application Date; and

- 3.2.2 twenty-three calendar days less one Business Day after the Statement of Works Assumptions Date.
- 3.3 The Company may refer as a Dispute to the Authority in accordance with Section H, paragraph 4.1, any TO Statement of Works Notice:
- 3.3.1 that a Transmission Owner does not require Transmission Construction Works to be undertaken in respect of a Statement of Works Project; or
- 3.3.2 of any assumptions which a Transmission Owner intends to make in relation to User Equipment at a Relevant Connection Site.
- 3.4 A Transmission Owner shall prepare each TO Statement of Works Notice so that, if the Statement of Works Project to which it relates is constructed, such Transmission Owner would continue to comply with the obligations in respect of the planning and development of its Transmission System set out in Part One, paragraph 2.2 of this Section D by giving effect to such Transmission Construction Works, except that:
- 3.4.1 for the purpose of Part One, paragraph 2.2, such Transmission Owner shall take into account Statement of Works Planning Assumptions provided to it under paragraph 2 (as modified or updated pursuant to paragraphs 2.4 or 2.6) in respect of the Statement of Works Project in the place of any other Planning Assumptions; and
- 3.4.2 the technical design and operational criteria for the Relevant Connection Site shall be as set out in The Company Request for a Statement of Works together with any site-specific information set out in the TO Statement of Works Notice.
- 3.5 In the event that The Company modifies Statement of Works Planning Assumptions after a Transmission Owner has submitted its TO Statement of Works Notice for the Statement of Works Project to which such Statement of Works Planning Assumptions apply, the Transmission Owner shall revise and re-submit its TO Statement of Works Notice to The Company, taking into account such modified Statement of Works Planning Assumptions, as soon as reasonably practicable.
- 3.6 At any time up to twenty-eight calendar days plus ninety-three Business Days after the User Application Date, The Company may submit to the Transmission Owner (and such submission shall be deemed to be) The Company Modification Application in respect of a Statement of Works Project. Processing of such deemed The Company Modification Application shall be as set out in Part Two of this Section D.

4 Evaluation of Transmission Impact

- 4.1 The ETI and the Transmission Impact Assessment (TIA) processes were introduced during CUSC modification CMP298 in order to facilitate the efficient assessment of relevant

embedded small, relevant embedded medium, or 'collectively relevant' power stations on an aggregated basis.

4.2 The ETI shall set the maximum values for the parameters identified in 4.3.1 to 4.3.4 (the "**Trigger Criteria**") which will require the Distribution Network Operator to apply for either a Statement of Works or Transmission Impact Assessment in order to connect any single or collectively relevant embedded generation.

4.3 Evaluation of Transmission Impact may require the Transmission Owner to submit **Trigger Criteria**, as agreed with NGESO and identified in 4.3.1 to 4.3.4, for Network Operators at GSPs within their network subject to a timetable agreed with NGESO.

4.3.1 Active Power (MW)

4.3.2 Apparent Power (MVA)

4.3.3 Reactive Power (MVAR)

4.3.4 Amperage (KA)

4.4 The **Trigger Criteria** for a given GSP may be applicable to local transmission assets or network assets away from each GSP. The network location to which the Trigger Criteria are applicable shall be stated by the Transmission Owner.

5 TRANSMISSION IMPACT ASSESSMENT PROCESS (TIA)

5.1 Upon receiving a request for a technically effective TIA from the NGESO the TO shall calculate a **Materiality Trigger**. This will be the capacity that will be allocated to a network operator at a specified GSP.

5.2 The method for calculation of the **Materiality Trigger** is at the discretion of the relevant TO however it is expected to be a function of the Transmission equipment capability minus currently connected demand/generation and network constraints.

5.3 A TIA will remain open until the NGESO informs the relevant TO that either the allocation has been connected or the allocation is no longer required by the network operator. The relevant TIA application will then be closed.

5.4 NGESO will provide monthly updates, or as requested, to the relevant TO on how much allocation has been used on an open TIA subject to receiving updates from the Network Operator.

PART FIVE: IMPLEMENTATION OF USER COMMITMENT METHODOLOGY

1. CMP 192 Transition Process Plan

1.1 The Company shall consult with and shall agree with each Transmission Owner the activities and the programme and timescales for the said activities required to be undertaken by that Transmission Owner in order to support The Company in the

implementation of the CMP 192 Transition Process Plan (the “UCM TO Implementation Plan”) including:

- (i) the issue by the Transmission Owner of a variation to a TO Construction Agreement so that the TO Construction Agreement is consistent with the requirements introduced at Schedule 8 and Schedule 9 in respect of Attributable Works; and
- (ii) the provision by the Transmission Owner of information (consistent with that which would be provided by the TO with a TO Construction Offer in accordance with the requirements introduced at Schedule 8 and Schedule 9) in respect of the Attributable Works in such TO Construction Agreement

and that Transmission Owner shall carry out all such activities as are specified in the UCM TO Implementation Plan in accordance with the timescales as set out in the UCM TO Implementation Plan unless otherwise agreed by the Transmission Owner and The Company.

SECTION E: BILLING AND PAYMENT

1. INTRODUCTION

1.1 This Section E sets out:

1.1.1 the constituent parts of TO Charges that are payable by The Company to Transmission Owners (and the constituent parts of The Company Charges that are payable by Transmission Owners to The Company the detailed description and method of calculation of which are set out in Schedule Ten and the Transmission Licences of the relevant Parties);

1.1.2 the invoicing and payment arrangements for TO Charges, The Company Charges and other payments payable by Parties under the Code or a TO Construction Agreement, including the dates upon which such payments fall due;

1.1.3 arrangements for dealing with disputes regarding TO Charges, The Company Charges and other amounts payable under the Code or a TO Construction Agreement; and

1.1.4 provisions in relation to the payment of interest on late payments and rights of dispute in relation to payments and otherwise pursuant under this Section E.

1.1.5 provisions in relation to data to be provided by Offshore Transmission Owners to The Company for the purposes of charge setting by The Company in accordance with the Use of System Charging Methodology.

2. TO CHARGES

2.1 The Company shall pay to Transmission Owners TO Charges comprising the following:

2.1.1 charges specified in Part One of Schedule Ten (referred to as "**TO General System Charges**");

2.1.2 charges specified in Part Two of Schedule Ten (referred to as "**TO Site-Specific Charges**"); and

2.1.3 charges specified in Part Five of Schedule Ten (referred to as "**Offshore Transmission Owner of Last Resort Charges**").

2.2 Each Transmission Owner shall determine its TO General System Charges in accordance with Part One of Schedule Ten.

2.3 Each Transmission Owner shall determine its TO Site-Specific Charges in accordance with Part Two of Schedule Ten.

2.4 Each Transmission Owner shall determine its Offshore Transmission Owner of Last Resort Charges in accordance with Part Five of Schedule Ten.

3. THE COMPANY CHARGES

- 3.1 Each Transmission Owner shall pay to The Company The Company Charges comprising the following:
- 3.1.1 charges specified in Part Four of Schedule Ten (referred to as "**Interruption Charges**");
 - 3.1.2 charges specified in Part Six of Schedule Ten (referred to as "**Offshore Construction Securities**"); and
 - 3.1.3 charges specified in Part Seven of Schedule Ten (referred to as "**Offshore Compensation Payments**").
 - 3.1.4 charges specified in Part Eight of Schedule Ten (referred to as "**Replacement Offshore Transmission Owner Charges**").
- 3.2 The Company shall determine the Interruption Charges in accordance with Part Four of Schedule Ten.
- 3.3 The Company shall determine the Offshore Construction Securities in accordance with Part Six of Schedule Ten.
- 3.4 The Company shall determine the Offshore Compensation Payments in accordance with Part Seven of Schedule Ten.
- 3.5 The Company shall determine the Replacement Offshore Transmission Owner Charges in accordance with Part Eight of Schedule Ten.

4. INVOICING AND PAYMENT

- 4.1 Each Party entitled to receive payment under this Code or a TO Construction Agreement, ("**Receiving Party**"), shall invoice the Party required to make such payment to the Receiving Party ("**Paying Party**") in accordance with the provisions of this Section E, unless otherwise specified in this Code, or such TO Construction Agreement or agreed between the Receiving Party and the Paying Party.
- 4.2 Other than in respect of TO Charges, the arrangements in relation to which are set out in paragraph 4.3 below, a Receiving Party shall despatch an invoice to the relevant Paying Party:
- 4.2.1 not less than thirty days prior to the due date for payment where such due date is specified or otherwise agreed between the Receiving Party and Paying Party; or
 - 4.2.2 not less than thirty days after the date on which such payment accrued, where such due date is not specified or otherwise agreed between the Receiving Party and Paying Party,
- and the Paying Party shall make such payment:

- (i) by the specified or otherwise agreed due date in the case of invoices received under sub-paragraph 4.2.1; or
 - (ii) within thirty days of the date of the Receiving Party's invoice under sub-paragraph 4.2.2.
- 4.3 The Company shall pay TO Charges and all other payments due under a TO Construction Agreement to Transmission Owners, in the following manner:
- 4.3.1 in the case of recurrent monthly TO Charges or other payments, on the later of:
 - 4.3.1.1 the 15th day following the day that the Transmission Owner's invoice therefor was despatched; and
 - 4.3.1.2 the 16th day of the month to which the invoiced TO Charges or other payments relate,unless, in any such case, such payment day is not a Business Day in which case payment shall be made on the next Business Day; or
 - 4.3.2 where TO Charges or other payments are payable other than monthly, within thirty days of the date of the Transmission Owner's invoice therefor.
- 4.4 The dates for payment as set out in paragraphs 4.2(i) and (ii), 4.3.1.1 and .43.1.2 and 3.3.2 above shall constitute, in each case, the "**Due Date**" for the purposes of this Section E.
- 4.5 All payments including, without limitation, TO Charges under this Section E shall be made in Pounds Sterling by the variable direct debit method, or such other form of bankers automated payment or other payment method or currency as shall be approved by the relevant Receiving Party, to the account number, bank and branch as the Receiving Party may from time to time notify to the relevant Paying Party.
- 4.6 Each Receiving Party shall provide such bank account information as a Paying Party reasonably requires from time to time in order to process payments to such Receiving Party in accordance with this Section E or otherwise under this Code or a TO Construction Agreement.
- 4.7 All payments payable under this Code and each TO Construction Agreement are (unless otherwise specified in this Code, such TO Construction Agreement or agreed between the relevant Receiving Party and Paying Party) exclusive of VAT, which shall be added to such payments, if applicable at the rate applicable at such time. All invoices issued by Parties pursuant to this Section E shall be valid VAT invoices and shall set out the requisite details of the taxable supply to which the given invoice relates.
- 4.8 All payments under this Code shall (except to the extent otherwise required by law) be paid in full, free and clear of and without deduction set off or deferment, save as

otherwise agreed by the Receiving Party and Paying Party or pursuant to a direction, other decision or award following a Dispute referred under paragraph 4.1 below.

- 4.9 Nothing in this Section E shall be construed as preventing a Receiving Party from withdrawing and replacing (without affecting the Due Date for payment) any invoice or associated statement before the Due Date for payment of such invoice, by agreement with the relevant Paying Party, where the Receiving Party is aware of any error in such invoice or associated statement.

5. **DISPUTES**

- 5.1 Any disputes arising out of or in relation to TO Charges, The Company Charges or other payments under a TO Construction Agreement, this Code or otherwise pursuant to this Section E, may be referred to the Authority as a Dispute in accordance with Section H, paragraph 5.1 of this Code.

- 5.2 If a Paying Party disputes any amount shown in an invoice or statement as payable by it in respect of any TO Charges, The Company Charges or other payments payable under a TO Construction Agreement or otherwise under this Section E, the Paying Party shall nevertheless pay the amount shown in full and may not withhold payment or any part thereof, but without prejudice to the Paying Party's right subsequently to refer such invoice or statement as a Dispute pursuant to paragraph 5.1 above.

6. **INTEREST ON LATE PAYMENT**

- 6.1 If any charges or payments payable under this Code or a TO Construction Agreement are not paid on or before the Due Date, unless otherwise specified in this Code, such TO Construction Agreement or otherwise agreed between the relevant Receiving Party and Paying Party, the Paying Party shall pay interest at the Default Interest Rate on the unpaid charge or payment from the Due Date until the day on which payment is made.

7. **DATA PROVIDED BY OFFSHORE TRANSMISSION OWNERS FOR USER CHARGE SETTING BY THE COMPANY**

- 7.1 The Company may request from an Offshore Transmission Owner, data in respect of the elements of TO Generator System Charges and TO Site Specific Charges, that it reasonably requires for the purposes of charge setting in accordance with the Use of System Charging Methodology. The Company will specify in any request made under this paragraph, the scope of data required and the timescales in which data is required.
- 7.2 Each Offshore Transmission Owner is required to provide The Company with data reasonably requested under sub paragraph 7.1.1 within the timescales specified in The Company's request.

SECTION F: COMMUNICATIONS AND DATA

1. INTRODUCTION

1.1 This Section F sets out:

1.1.1 general obligations of confidentiality, including restrictions on the circumstances in which Confidential Information may be Disclosed by a Party to its Affiliates, Related Undertakings, employees or to any third parties; and

1.1.2 restrictions on the circumstances in which information may be provided by a Party to a Transmission Owner under this Code.

2. GENERAL CONFIDENTIALITY

2.1 Each Party undertakes that it shall at all times:

2.1.1 keep all Confidential Information confidential and, except as expressly permitted under sub-paragraph 2.1.3, not Disclose any Confidential Information to any of its Affiliates, Related Undertakings, employees or to any other person;

2.1.2 not copy or use in any manner any Confidential Information for any purposes other than the Permitted Activities;

2.1.3 provide copies of the Confidential Information only to those Business Personnel who properly require access to the Confidential Information and always on a strict need-to-know basis solely for or in relation to the Permitted Activities, and inform each of them of the restrictions contained in this Section F; and

2.1.4 procure that any Business Personnel or other person(s) to whom it discloses Confidential Information observe(s) the restrictions set out in this Section F, and be responsible for any failure by such person(s) to observe such restrictions.

2.2 Nothing in this paragraph 2 shall apply to:

2.2.1 any Confidential Information which has entered the public domain otherwise than as a direct or indirect result of any contravention of this Section F; or

2.2.2 any Confidential Information which, after it is furnished to Business Personnel:

2.2.2.1 is acquired by a Party in circumstances in which this paragraph 2 does not apply; or

2.2.2.2 is acquired by a Party in circumstances in which this paragraph 2 does apply and thereafter ceases to be subject to the restrictions imposed by this paragraph 2,

otherwise than as a direct or indirect result of any contravention of this Section F or any other confidentiality obligation binding upon the person Disclosing such Confidential Information; or

2.2.3 any Confidential Information Disclosed to any person where the Disclosing Party, in making the Disclosure, is expressly permitted or required to make such Disclosure to such person:

2.2.3.1 in compliance with the duties of such Disclosing Party under any Relevant Instrument or any other Legal Requirement or requirement of a Competent Authority; or

2.2.3.2 in compliance with the conditions of the Disclosing Party's Transmission Licence; or

2.2.3.3 in response to a requirement of any stock exchange or regulatory authority or the Panel on Take-Overs and Mergers; or

2.2.3.4 pursuant to the arbitration rules of the Electricity Arbitration Association or pursuant to any judicial or other arbitral process or tribunal having jurisdiction in relation to the Disclosing Party or its Affiliates or Related Undertakings; or

2.2.4 any Confidential Information to the extent that a Disclosing Party is expressly permitted or required to Disclose that information under the terms of this Code; or

2.2.5 any Confidential Information in relation to the affairs of a User, to the extent that the Disclosing Party is expressly permitted or required to Disclose that information under any arrangement with such User; or

2.2.6 a Disclosure of any Confidential Information by the Disclosing Party to the Authority or any other Competent Authority.

2.3 For the avoidance of doubt, nothing in this paragraph 2 shall apply to any Disclosure of Confidential Information by The Company to the extent that it is expressly permitted or required to Disclose such Confidential Information under the terms of an Other Code.

2.4 Each Party undertakes that, having regard to the activities in which any Business Person of such Party is engaged and the nature and effective life of any Confidential

Information divulged to them by virtue of such activities, such Party shall not unreasonably continue (taking into account any industrial relations concerns reasonably held by it) to divulge Confidential Information to any such Business Person in relation to whom such Party has become aware of their intention to become engaged as an employee or agent of any other person who is:

2.4.1 authorised by Licence or Exemption to generate, participate in the transmission of, distribute or supply electricity; or

2.4.2 an electricity broker or who is known to be engaged in the writing of electricity sale and purchase contracts (which shall include the entering into or acquiring the benefit of a contract conferring rights or obligations by way of option, in relation to or by reference to the sale, purchase or delivery of electricity at any time or the price at which electricity is sold or purchased at any time); or

2.4.3 known to be retained as a consultant to any such person who is referred to in sub-paragraphs 2.4.1 and 2.4.2,

save where the Party could not, in all the circumstances, reasonably be expected to refrain from divulging to such Business Person Confidential Information which is required for the proper performance of their duties.

2.5 Without prejudice to the other provisions of this paragraph 2, each Party shall procure that any additional copies made of the Confidential Information, whether in hard copy or computerised form, will clearly identify the Confidential Information as confidential.

2.6 Notwithstanding any other provision of the Code, the provisions of this paragraph 2 shall continue to bind each Party after its cessation as a Party for whatever reason.

3. RESTRICTIONS ON THE PROVISION OF INFORMATION BETWEEN THE PARTIES

3.1 For the avoidance of doubt, any provision of this Code which provides for co-operation and assistance between the Parties or which otherwise permits or requires the provision of information between the Parties shall remain subject to the restrictions set out in this paragraph 3.

3.2 A Party shall not Disclose any information which it receives under or pursuant to this Code to a Transmission Owner other than in the course of performing its respective rights and obligations under this Code.

3.3 A Party shall not Disclose any Transmission Information or User Data to a Transmission Owner under this Code or otherwise other than:

3.3.1 as, and to the extent, set out in Schedule Three; and

3.3.2 any incidental information which is reasonably required to support or clarify, or that is otherwise directly related to, information Disclosed under sub-paragraph 3.3.1.

3.4 Paragraphs 3.2 and 3.3 shall not apply to:

3.4.1 information that is in the public domain (otherwise than as a direct or indirect result of any contravention of this Section F); or

3.4.2 any information which the Disclosing Party is expressly permitted or required to Disclose to the Transmission Owner:

3.4.2.1 in compliance with the duties of such Disclosing Party under any Relevant Instrument or any other Legal Requirement or requirement of a Competent Authority; or

3.4.2.2 in compliance with the conditions of the Disclosing Party's Transmission Licence; or

3.4.2.3 in response to a requirement of any stock exchange or regulatory authority or the Panel on Take-Overs and Mergers; or

3.4.2.4 pursuant to the arbitration rules of the Electricity Arbitration Association or pursuant to any judicial or other arbitral process or tribunal having jurisdiction in relation to the Disclosing Party or its Affiliates or Related Undertakings; or

3.4.3 any information which the Disclosing Party has first made available to all Parties and all Other Code Parties on equivalent terms (including, without limitation, as to charges and non-Disclosure obligations) and otherwise in accordance with paragraph 3.5.

3.5 For the purpose of sub-paragraph 3.4.3 above, a Party shall make available information by publishing a notice on the Code Website stating that such information is available (or, where the Disclosing Party is a Transmission Owner, by forwarding such notice to The Company, which notice The Company shall then promptly publish on the Code Website).

3.6 For the avoidance of doubt, nothing in this paragraph 3 shall be taken to limit or restrict the information which may be Disclosed by a Party to The Company under this Code.

3.7 Information which a Party is permitted or obliged to Disclose to any other Party pursuant to this Code shall not be regarded as being in the public domain by reason only of being so Disclosed.

1. 3.8 Notwithstanding any other provision of the Code, the provisions of this paragraph 3 shall continue to bind each Party after its cessation as a Party for whatever reason.

SECTION G: GENERAL PROVISIONS

1. INTRODUCTION

- 1.1 This Section G contains those provisions that are generic to this Code including, inter alia:
- 1.1.1 provisions to be adhered to by the Parties in relation to safety and environmental issues and nuclear installations;
 - 1.1.2 the limitation of liability of Parties under the Code and the third party rights that apply;
 - 1.1.3 the restrictions on transfer and subcontracting of Parties' rights and obligations under the Code, Framework Agreement or any TO Construction Agreement and the arrangements to apply on disposal by a Party of the whole or a part of its business; and
 - 1.1.4 other provisions defining the legal and contractual relationship between the Parties under this Code.

2. SAFETY AND ENVIRONMENT

2.1 General

- 2.1.1 For the avoidance of any doubt, nothing in or pursuant to this Code shall:
- 2.1.1.1 be taken to require a Party to do anything which could or would be unsafe or contrary to that Party's environmental obligations; nor
 - 2.1.1.2 prevent a Party from doing anything which could or would be unsafe or contrary to that Party's environmental obligations to omit to do.
- 2.1.2 A Transmission Owner shall notify The Company in the event that, and as soon as, such Transmission Owner:
- 2.1.2.1 becomes aware that, for safety purposes or pursuant to environmental obligations of such Transmission Owner, the Transmission Owner is reasonably likely to configure, or has urgently had to configure, any part of its Transmission System or otherwise take any steps other than in accordance with a direction from The Company; or
 - 2.1.2.2 becomes aware that, for safety purposes or pursuant to environmental obligations of such Transmission Owner, it is reasonably likely to be, or has been, prevented, restricted or delayed from complying with a direction from The Company in relation to the configuration of any part of its Transmission System.
- 2.1.3 Each Party shall use its best endeavours to identify and remove or lessen the likelihood of any circumstances arising in which such Party might seek to place

reliance upon the provisions of paragraph 2.1.1 including, without limitation, by discussing such issues with the other Parties where appropriate.

2.2 User and Transmission Owner Safety Requirements

2.2.1 Notwithstanding that a Transmission Owner is not a party to the CUSC and is not thereby required to comply with the Grid Code, a Transmission Owner shall comply with:

2.2.1.1 the relevant appendix of Operating Code No 8 of the Grid Code as notified by The Company; and

2.2.1.2 (in carrying out its obligations under Section D, Part Two, paragraph 14), Appendix 1 of the Connection Conditions in respect of Type 1 Transmission Owners or Appendix 1 of the European Connection Conditions in respect of Type 2 Transmission Owners of the Grid Code as applicable

(each as amended from time to time).

2.2.2 The Company shall comply with, and shall procure that a User shall comply with, the relevant appendix of OC8 and Appendix 1 of the Connection Conditions as applicable to GB Code User's or OC8 and Appendix E1 of the European Connection Conditions as applicable to EU Code User's of the Grid Code where and to the extent that such section applies to The Company and the User.

2.2.3 Each Transmission Owner shall provide to The Company a copy of and any updates to its Safety Rules as applicable from time to time.

2.2.4 The Company shall ensure that no busbar Protection, mesh corner Protection, circuit-breaker fail Protection relays, AC or DC wiring (other than power supplies of DC tripping associated with a Generating Unit itself) may be worked upon or altered by Generator personnel in the absence of a representative of the Transmission Owner or written authority from the Transmission Owner to whose Transmission System the Connection Site at which such works are to be undertaken is connected.

2.2.5 Where a Transmission Owner owns the busbar Protection at the Connection Point Site, The Company shall ensure that no busbar Protection, circuit-breaker failure Protection relays, AC or DC wiring (other than power supplies of DC tripping associated with the Network Operator or Non-Embedded Customer's Apparatus itself) may be worked upon or altered by the Network Operator or Non-Network Operator or Non-Embedded Customer's personnel in the absence of a representative of the Transmission Owner or written authority from the Transmission Owner.

2.2.6 A Transmission Owner shall use its best endeavours to provide a representative or to submit a written authority to The Company on request from The Company for the purposes of paragraphs 2.2.4 and 2.2.5.

- 2.2.7 Unless otherwise agreed pursuant to paragraph 2.2.9, a Transmission Owner entering and working on its Plant and/or Apparatus on a User Site will work to such User's Safety Rules as advised by and forwarded to the Transmission Owner by The Company.
- 2.2.8 Unless otherwise agreed pursuant to paragraph 2.2.10, The Company shall procure that a User entering and working on that User's Plant and/or Apparatus on a Transmission Owner Site will work to the Transmission Owner's Safety Rules, which Safety Rules, the Transmission Owner shall forward to the User directly as directed by The Company and notify The Company that it has done so.
- 2.2.9 A Transmission Owner may, with a minimum of six weeks notice, apply to The Company for permission to work according to its own Safety Rules when working on its own Plant and/or Apparatus at a User Site rather than the User's Safety Rules. The Company shall consult with the relevant User and, subject to The Company and the User's agreement that the Transmission Owner's Safety Rules provide for a level of safety commensurate with those set out in paragraph 2.2.7, The Company will notify the Transmission Owner in writing that, with effect from the date requested by the Transmission Owner, the Transmission Owner may use its own Safety Rules when working on the Transmission Owner's Plant and/or Apparatus on that User Site, which Safety Rules, the Transmission Owner shall forward to the User directly as directed by The Company and notify The Company that it has done so. Until such written approval from The Company, the Transmission Owner will continue to use the Safety Rules in accordance with paragraph 2.2.7.
- 2.2.10 The Company may (on behalf of a User), with a minimum of six weeks notice, apply to a Transmission Owner and consult with that Transmission Owner regarding permission for work to be carried out to the User's Safety Rules when work is carried out by such User on the User's Plant and/or Apparatus at the Transmission Owner's Site rather than the Transmission Owner's Safety Rules. If the Transmission Owner and The Company agree that the User's Safety Rules provide for a level of safety commensurate with those set out in paragraph 2.2.8, The Company will notify the User in writing, copied to the Transmission Owner, that, with effect from the date requested by the User, the User may use its own Safety Rules when working on such User's Plant and/or Apparatus on that Transmission Owner's Site, which Safety Rules, The Company shall procure that the User shall forward to the Transmission Owner directly. Until such written approval from The Company, The Company shall procure that the User shall continue to use the Transmission Owner's Safety Rules in accordance with paragraph 2.2.8.
- 2.2.11 If, pursuant to paragraph 2.2.9, The Company notifies a Transmission Owner that the Transmission Owner's own Safety Rules shall apply, this shall not imply that the Transmission Owner's Safety Rules will apply to entering the User's Site and access to the Transmission Owner's Plant and/or Apparatus on that User's Site.

A User has responsibility for the whole of its User Site and entry and access will always be in accordance with such User's Site access procedures.

- 2.2.12 If, pursuant to paragraph 2.2.10, The Company notifies a User that the User's own Safety Rules shall apply, this shall not imply that, for such Transmission Owner's Site, the User's Safety Rules will apply to entering the Transmission Owner's Site, and access to the User's Plant and/or Apparatus on that Transmission Owner's Site. A Transmission Owner has responsibility for the whole of its Transmission Owner Site and entry and access will always be in accordance with such Transmission Owner's Site access procedures.

3. NUCLEAR INSTALLATIONS

- 3.1 Where required by The Company upon reasonable notice, a Transmission Owner shall take any reasonable and proper action whatsoever to the extent necessary in order to comply with (or avert an anticipated breach of) any of the matters specified in paragraph 3.2.
- 3.2 The matters referred to in paragraph 3.1 are any covenant, agreement, restriction, stipulation, instruction, provision, condition or notice contained, or referred to, in a licence for the time being in force, granted in accordance with the Nuclear Installations Act 1995 (or legislation amending, replacing or modifying the same), or any consent, or approval issues, or to take effect from time to time under such licence, any emergency arrangements, operating rules or other matters from time to time under such licence, any emergency arrangements, operating rules or other matters from time to time approved by the relevant authority under, or pursuant to, any such agreements, restrictions, stipulations, instructions, conditions or notices.
- 3.3 The Company shall indemnify and keep indemnified any Transmission Owner for any loss, damage, costs and expenses incurred by that Transmission Owner as a consequence of any action of that Transmission Owner pursuant to paragraph 3.1 (to the extent that the action was not required by any licence or agreement binding on that Transmission Owner).
- 3.4 Where requested by The Company upon reasonable notice, SP Transmission Limited and NGET shall provide such information and advice in relation to their respective obligations and rights under the Scottish NSLPAs and E&W NSLPAs as shall be reasonable to enable The Company to comply with its obligations under the Code, the Grid Code and the CUSC.
- 3.5 Where requested by The Company upon reasonable notice, SP Transmission Limited and NGET shall undertake such actions in relation to their respective obligations and rights under the Scottish NSLPAs and E&W NSLPAs as shall be reasonable to enable The Company to comply with its obligations under the Code, the Grid Code and the CUSC.
- 3.6 Where requested by SP Transmission Limited upon reasonable notice, The Company shall provide such information and advice as shall be reasonable to enable SP Transmission Limited to comply with the Scottish NSLPAs. Where requested by NGET

upon reasonable notice, The Company shall provide such information and advice as shall be reasonable to enable NGET to comply with the E&W NSLPAs.

- 3.7 Where requested by SP Transmission Limited upon reasonable notice, The Company shall undertake such actions as shall be reasonable to enable SP Transmission Limited to comply with the Scottish NSLPAs. Where requested by NGET upon reasonable notice, The Company shall undertake such actions as shall be reasonable to enable NGET to comply with the E&W NSLPAs.
- 3.8 SP Transmission Limited and NGET shall notify The Company as soon as reasonable practicable of any proposal to amend the Scottish NSLPAs and E&W NSLPAs respectively and shall consult with The Company in relation to the potential impact of any such proposal on the Code, the Grid Code and the CUSC to ensure that the views of The Company on that proposal are obtained and, where The Company so requires, communicated to the relevant counterparty to the Scottish NSLPAs or E&W NSLPAs.
- 3.9 The Company shall notify SP Transmission Limited and NGET as soon as reasonably practicable of any proposal to amend the Code and/or the Grid Code and/or the CUSC which may affect the Scottish NSLPAs and/or E&W NSLPAs and shall consult with SP Transmission Limited and NGET in relation to the potential impact of any such proposal on the Scottish NSLPAs and/or E&W NSLPAs to ensure that the views of SP Transmission Limited and NGET on that proposal are obtained and, where SP Transmission Limited and/or NGET so requires, considered as part of the consultation process in relation to the Grid Code and the CUSC.

4. LIMITATION OF LIABILITY

- 4.1 This paragraph 4, insofar as it excludes or limits liability, shall override any other provision in the Code provided that nothing in this paragraph 4 shall exclude or restrict or otherwise prejudice or affect any of:
- 4.1.1 the rights, powers, duties and obligations of any Party which are conferred or created by the Act, that Party's Transmission Licence, or the Regulations; or
- 4.1.2 the rights, powers, duties and obligations of the Authority or the Secretary of State under the Act, any Transmission Licence or otherwise howsoever.
- 4.2 Subject to any liquidated damages provisions of any TO Construction Agreement and to the indemnities provided for under paragraphs 3.3 and 4.3 of this Section G, each Party agrees and acknowledges that no Party (the "**Party Liable**") nor any of its officers, employees or agents shall be liable to any other Party, for loss arising from any breach of the Code or TO Construction Agreement, other than for loss directly resulting from such breach and which, at the date hereof, was reasonably foreseeable as not unlikely to occur in the ordinary course of events from such breach in respect of:
- 4.2.1 physical damage to the property of any other Party or its respective officers, employees or agents; or

4.2.2 the liability of any other Party, its officers, employees or agents to any other person for loss in respect of physical damage to the property of that or any other person, subject, for the avoidance of doubt, to the requirement that the amount of such liability claimed by such other Party should be mitigated in accordance with general law.

provided that the liability of any Party in respect of all claims for such loss shall not exceed £5million per incident or series of related incidents unless the incident or series of related incidents arise on or affect a part of a Distribution System required to connect the Offshore Transmission System where the liability of any Party shall not exceed £1 million.

4.3 Nothing in this Code shall exclude or limit the liability of the Party Liable or restrict the ability of any Party to claim in respect of fraudulent misrepresentation or death or personal injury resulting from the negligence of the Party Liable and the Party Liable shall indemnify and keep indemnified each other Party from and against all such and any loss or liability which any such other Party may suffer or incur by reason of any claim on account of fraudulent misrepresentation or death or personal injury resulting from the negligence of the Party Liable or any of its officers, employees or agents.

4.4 In consideration of the rights conferred upon each Transmission Owner under the Code, the right of any of the Transmission Owners to claim in negligence, other tort, or otherwise howsoever against a CUSC Party (other than The Company) in respect of any act or omission of such CUSC Party (other than The Company) in relation to the subject matter of the CUSC is hereby excluded and each Transmission Owner agrees not to pursue any such claim save that nothing in this paragraph 4.4 shall restrict the ability of a Transmission Owner to claim in respect of fraudulent misrepresentation or death or personal injury resulting from the negligence of the CUSC Party (other than The Company).

4.5 In consideration of the rights conferred upon each Offshore Transmission Owner under the Code, the right of any of the Offshore Transmission Owners to claim in negligence, other tort, or otherwise howsoever against a DCUSA Party (other than The Company) in respect of any act or omission of such DCUSA Party (other than The Company) in relation to the subject matter of the DCUSA is hereby excluded and each Offshore Transmission Owner agrees not to pursue any such claim save that nothing in this paragraph 4.5 shall restrict the ability of an Offshore Transmission Owner to claim in respect of fraudulent misrepresentation or death or personal injury resulting from the negligence of the DCUSA Party (other than The Company).

4.6 Subject to any liquidated damages provisions of any TO Construction Agreement, and to the indemnities provided for under paragraphs 3.3 and 4.3 of this Section G, the Party Liable nor any of its officers, employees or agents, shall not in any circumstances whatsoever be liable in relation to the Code or its obligations under the Code, to another Party for:

4.6.1 any loss of profit, loss of revenue, loss of use, loss of contract or loss of goodwill;
or

- 4.6.2 any indirect or consequential loss; or
- 4.6.3 loss resulting from the liability of another Party to any other person howsoever and whensoever arising, save as provided in sub-paragraph 4.2.1 and 4.2.2.
- 4.7 The rights and remedies provided by the Code to the Parties are exclusive and not cumulative and exclude and are in place of all substantive (but not procedural) rights or remedies express or implied and provided by common law or statute in respect of the subject matter of the Code, including, without limitation, any rights any Party may possess in tort which shall include actions brought in negligence and/or nuisance. Accordingly, each of the Parties hereby waives to the fullest extent possible all such rights and remedies provided by common law or statute, and releases a Party which is liable to another Party or other Parties, its or their officers, employees and agents to the same extent from all duties, liabilities, responsibilities or obligations provided by common law or statute in respect of the matters dealt with in the Code and undertakes not to enforce any of the same except as expressly provided herein.
- 4.8 Each of the paragraphs of this paragraph 4 shall:
- 4.8.1 be construed as a separate and several contract term, and if one or more of such paragraphs is held to be invalid, unlawful or otherwise unenforceable the other or others of such paragraphs shall remain in full force and effect and shall continue to bind the Parties; and
- 4.8.2 survive termination of the Code and/or the Framework Agreement.
- 4.9 Each Party acknowledges and agrees that each of the other Parties holds the benefit of paragraphs 4.2 to 4.7 above for itself and as trustee and agent for its officers, employees and agents.
- 4.10 Each Party acknowledges and agrees that the provisions of this paragraph 4 have been the subject of discussion and negotiation and are fair and reasonable having regard to the circumstances as at the Code Effective Date.
- 4.11 For the avoidance of doubt, nothing in this paragraph 4 shall prevent or restrict any Party enforcing any obligation (including suing for a debt) owed to it under or pursuant to the Code.

5. THIRD PARTY RIGHTS

- 5.1 Subject to the remainder of this paragraph 5, a CUSC Party (other than The Company) may rely upon and enforce the terms of paragraph 4.4, against a Transmission Owner, a DCUSA Party (other than The Company) may rely upon and enforce the terms of paragraph 4.5, against an Offshore Transmission Owner and an Other Code Party (other than The Company) may rely upon and enforce the terms of Section F, sub-paragraph 3.4.3 against a Party.

- 5.2 The third party rights referred to in paragraph 5.1 may only be enforced by the relevant third party subject to and in accordance with the provisions of the Contracts (Rights of Third Parties) Act 1999 and all other relevant terms of this Code.
- 5.3 Notwithstanding any other provision of the Code, the Parties may (pursuant to Section B), amend the Code without the consent of a third party and accordingly, section 2(1) of the Contracts (Rights of Third Parties) Act 1999 shall not apply, save that, where and to the extent that any amendment to the Code would have an impact on the rights of third parties conferred under paragraph 5.1, then The Company shall bring such impact to the attention of Parties and third persons to the extent that such impact is not already brought to their attention in a STC Modification Proposal by the Proposer.
- 5.4 Except as provided in paragraph 5.1, a person who is not a Party has no right under the Contracts (Rights of Third Parties) Act 1999 to rely upon or enforce any term of the Code but this does not affect any right or remedy of a third party which exists or is available other than pursuant to that Act.

6. TRANSFER AND SUB-CONTRACTING

- 6.1 The rights, powers, duties and obligations of a Party under the Framework Agreement, the Code or any TO Construction Agreement are personal to that Party and that Party may not assign or transfer the benefit or burden of those documents save in the following circumstances:
- 6.1.1 upon the disposal by that Party of the whole of its business or undertaking it shall have the right to transfer its rights and obligations under the Framework Agreement, the Code or any TO Construction Agreement to the purchaser thereof on condition that the purchaser (if not already a Party) enters into an Accession Agreement pursuant to Section B and confirms to the relevant Parties in writing either that all of the technical or related conditions, data, information, operational issues or other matters notified and/or agreed pursuant to Part One, Section C, paragraphs 3 and 4 or any other matters specified in or pursuant to a relevant TO Construction Agreement, by the purchaser will remain unchanged or, if any such matters are to be changed, the purchaser first notifies the relevant Parties in writing of such changes which the relevant Parties will consider and, until such consideration is complete, the transfer shall not be effective. If, having considered such changes, the relevant Parties in their reasonable opinion do not consider the proposed changes reasonably satisfactory to relevant Parties, they shall consult with the purchaser and, pending the outcome thereof to the relevant Parties' reasonable satisfaction, the transfer shall not be effective, provided always, that any failure to reach an agreement under this sub-paragraph 6.1.1 may be referred by a Party as a Dispute to the Authority under Section H, paragraph 4.1. Such transfer shall become effective once the changes are reasonably satisfactory to the

relevant Parties or have been determined to be so following resolution of such Dispute;

6.1.2 upon the disposal by a Party of part of its business or undertaking comprising a part of its Transmission System that Party shall have the right to transfer its rights and obligations under this Code or any TO Construction Agreement to the purchaser thereof on condition that the purchaser (if not already a Party) enters into an Accession Agreement pursuant to Section B and confirms to the relevant Parties in writing either that all of the technical or related conditions, data, information, operational issues or other matters notified and/or agreed pursuant to Part One, Section C, paragraphs 3 and 4 by the purchaser will remain unchanged or if any such matters are to be changed, the purchaser first notifies the relevant Parties in writing of such changes which the relevant Parties will consider promptly and in any event within 28 days of receiving notice of such change and until such consideration is complete the assignment shall not be effective. If having considered such changes the relevant Parties in their reasonable opinion do not consider the proposed changes reasonably satisfactory to the relevant Parties, they shall consult with the purchaser and pending the outcome thereof to the relevant Parties' reasonable satisfaction the transfer shall not be effective, provided always, that any failure to reach an agreement under this sub-paragraph 6.1.2 may be referred by a Party as a Dispute to the Authority under Section H, paragraph 4.1. Such transfer shall become effective once the changes are reasonably satisfactory to the Parties or have been determined to be so under Section H; and

6.1.3 a Party may assign or charge its rights or benefits under the Framework Agreement, the Code or any TO Construction Agreement in whole or in part by way of security.

6.2 Each Party shall have the right to sub-contract or delegate the performance of any of its obligations or duties arising under the Code without the prior consent of any other Party. The subcontracting by a Party of the performance of any obligations or duties under the Framework Agreement, the Code or any TO Construction Agreement shall not relieve that Party from liability for performance of such obligation or duty.

6.3 It is acknowledged that the undertaking of OTSDUW by a User does not constitute subcontracting by a Transmission Owner. Nevertheless, the Transmission Owner shall be responsible for the OTSUA (once they form part of the Transmission System) as if the OTSDUW had been undertaken by (or on behalf) of the Transmission Owner.

7. INTELLECTUAL PROPERTY

7.1 All Intellectual Property Rights relating to the subject matter of the Code or any TO Construction Agreement conceived, originated, devised, developed or created by a Party, its officers, employees, agents or consultants during the currency of the Code or any TO Construction Agreement shall vest in such Party as sole beneficial owner thereof save where the Parties agree in writing or the provisions of this Code expressly state otherwise.

8. FORCE MAJEURE

8.1 If any Party (the "**Non-Performing Party**") shall be unable to carry out any of its obligations under the Code or any TO Construction Agreement due to a circumstance of Force Majeure, the Code or any TO Construction Agreement shall remain in effect, but:

- 8.1.1 the Non-Performing Party's relevant obligations;
- 8.1.2 the obligations of each of the other Parties owed to the Non-Performing Party under the Code or TO Construction Agreement as the case may be; and
- 8.1.3 any other obligations of the other Parties under the Code or TO Construction Agreement owed between themselves which the relevant Party is unable to carry out directly as a result of the suspension of the Non-Performing Party's obligations,

shall be suspended for a period equal to the circumstance of Force Majeure provided that:

- (a) such circumstances do not constitute a Secured Event;
- (b) the suspension of performance is of no greater scope and of no longer duration than is required by the Force Majeure;
- (c) no obligations of any Party that arose before the Force Majeure causing the suspension of performance are excused as a result of the Force Majeure;
- (d) the Non-Performing Party gives the other Parties prompt notice describing the circumstance of Force Majeure, including the nature of the occurrence and its expected duration, and continues to furnish regular reports to the other Parties with respect thereto during the period of Force Majeure;
- (e) the Non-Performing Party uses all reasonable efforts to remedy its inability to perform; and
- (f) as soon as practicable after the event which constitutes Force Majeure, the Parties shall discuss how best to continue their operations so far as possible in accordance with the Code or TO Construction Agreement.

9. PRIVILEGE

9.1 No Party shall be required to produce documents pursuant to any provision of the Code which such Party could not be compelled to produce in civil proceedings in any court in England and Wales or Scotland or to supply information which such Party could not be compelled to give in evidence in any such proceedings.

10. WAIVER

10.1 No delay by or omission of any Party or the STC Modification Panel (including the Panel Secretary) in exercising any right, power, privilege or remedy under the Code, the

Framework Agreement or any TO Construction Agreement shall operate to impair such right, power, privilege or remedy or be construed as a waiver thereof.

10.2 Any single or partial exercise of any such right, privilege or remedy shall not preclude any other or future exercise thereof or the exercise of any other right, power, privilege or remedy.

10.3 For the avoidance of doubt, the Parties acknowledge and agree that nothing in the Code, Framework Agreement or any TO Construction Agreement shall exclude or restrict or otherwise prejudice or affect any of the rights, powers, privileges, remedies, duties and obligations of the Secretary of State or the Authority under the Act or any Transmission Licence or otherwise under any applicable law.

11. NOMINATED REPRESENTATIVE

11.1 Each Party undertakes to the other Parties that where, under any provision of the Code, action is taken by a representative of that Party, it shall ensure that its representative is duly authorised to take such action.

12. COMMUNICATIONS

12.1. Save to the extent otherwise set out in the Code or any TO Construction Agreement or otherwise agreed by the Parties, any notice, direction, request or other communication to be given by one Party to another under or in connection with the matters contemplated by the Code, the Framework Agreement or any TO Construction Agreement shall be addressed to the recipient and sent to the address or facsimile number of such other Party provided under Section B.

12.2 Such notice or other communication, shall be in writing and shall be given by letter delivered by hand or sent by first class prepaid post (airmail if overseas) or facsimile unless otherwise specified in this Code or otherwise agreed between the Parties, and shall be deemed to have been received:

12.2.1 in the case of delivery by hand, when delivered; or

12.2.2 in the case of first class prepaid post, on the second day following the day of posting or (if sent airmail overseas or from overseas) on the fifth day following the day of posting; or

12.2.3 in the case of facsimile, on acknowledgement of the addressee's facsimile receiving equipment (where such acknowledgement occurs before 1700 hours on the day of acknowledgement and in any other case on the day following the day of acknowledgement).

12.3 Each Party shall use all reasonable endeavours to ensure that all information provided from that Party to another is accurate and complete and submitted in good faith.

12.4 The provisions of this paragraph 12 extend to any notice or other communication to be given by or to the Panel Secretary.

13. COUNTERPARTS

- 13.1 The Accession Agreement, Framework Agreement and any TO Construction Agreement or Code Procedures may be executed in any number of counterparts and by the different parties on separate counterparts, each of which when executed and delivered shall constitute an original, but all the counterparts shall together constitute one and the same instrument.

14. SEVERANCE OF TERMS

- 14.1 If any provision of the Code or any TO Construction Agreement is or becomes or is declared invalid, unenforceable or illegal by the courts of any competent jurisdiction to which it is subject or by order of any other Competent Authority such invalidity, unenforceability or illegality shall not prejudice or affect the remaining provisions of the Code or TO Construction Agreement which shall continue in full force and effect notwithstanding such invalidity, unenforceability or illegality.

15. LANGUAGE

- 15.1 Every notice or other communication to be given by one Party to another under the Code shall be in the English language.

16. DATA PROTECTION ACT

- 16.1 Each Party warrants that it has effected, and undertakes that it will during the term of the Code effect and maintain all such notifications and registrations as it is required to effect and maintain under the Data Protection Act 1998 to enable it to lawfully perform the obligations imposed on it by the Code.
- 16.2 Each Party undertakes to comply with the Data Protection Act 1998 in the performance of its obligations under the Code.
- 16.3 Each Party undertakes that, in any case where information to be disclosed by it under the Code may lawfully be disclosed only with the prior consent of the person to whom the information relates, it will use its reasonable endeavours to obtain such prior consents so as to enable it promptly to perform its obligations under as envisaged by the Code.

17. JURISDICTION

- 17.1 Subject to Section H, the Parties irrevocably agree that only the courts of England and Wales and the courts of Scotland are to have jurisdiction to settle any disputes which may arise out of or in connection with this Code or any TO Construction Agreement and that accordingly any claim or action ("**Proceedings**") arising out of or in connection with this Code or any TO Construction Agreement may be brought in such courts.

17.2 Each Party irrevocably waives any objection which it may have now or hereafter to the laying of the venue of any Proceedings in any such court as is referred to in this paragraph 17 and any claim that any such Proceedings have been brought in an inconvenient forum and further irrevocably agrees that judgement in any Proceedings brought in the courts of England and Wales or the courts of Scotland shall be conclusive and binding upon such Party and may be enforced in the courts of any jurisdiction.

17.3 For the avoidance of doubt, nothing contained in paragraphs 17.1 and 17.2 above shall be taken as permitting a Party to commence Proceedings in the courts where the Code otherwise provides for Proceedings to be referred to arbitration or to the Authority.

18. GOVERNING LAW

18.1 This Code and any TO Construction Agreement shall be governed by and construed in accordance with English law.

19. NO PARTNERSHIP

19.1 Nothing in this Code is intended to or shall operate to create a partnership or joint venture of any kind between the Parties.

20. TRANSMISSION DEROGATIONS

20.1 A Party's obligation(s) under this Code shall be relieved, as regards any other Party, to the extent and for such period as such obligation(s) are specified as being relieved by a direction issued by the Authority under paragraph 15 of Standard Condition B12 of its Transmission Licence or under paragraph 4 of Standard Condition E13 of its Transmission Licence as appropriate.

21. [NOT USED]

SECTION H: DISPUTES

1. INTRODUCTION

1.1 This Section H sets out:

- 1.1.1 the obligations on the Parties to escalate and seek to resolve Disputes;
- 1.1.2 the types of Dispute that are referable to the Authority under this Code and the arrangements and obligations in relation to such referrals; and
- 1.1.3 the types of Dispute that are referable to arbitration under this Code and the arrangements and obligations in relation to such referrals.

2. GENERAL

2.1 Subject to any contrary provision of the Act, any Transmission Licence and the Regulations, and the rights, powers, duties and obligations of the Authority or the Secretary of State under the Act or Transmission Licences or otherwise howsoever, any Dispute between the Parties shall be resolved as provided in the applicable Section of this Code and this Section H.

3. ESCALATION

- 3.1 Notwithstanding the remaining provisions of this Section H, Parties shall identify and progress Disputes without undue delay and consistently with the objective of resolving such Disputes as early and as efficiently as reasonably practicable.
- 3.2 A Party may raise a Dispute by issuing a Dispute Notice to the Authority and each of the other Dispute Parties.
- 3.3 As soon as reasonably practicable, and in any event within 10 Business Days (or such longer period as the Dispute Parties may agree) of the date of issue of a Dispute Notice, representatives of each of the Dispute Parties who have authority to resolve the Dispute shall use their best endeavours to seek to resolve such Dispute.
- 3.4 If the Dispute Parties are unable to resolve a Dispute pursuant to paragraph 3.3, then the Dispute Parties' obligations under that paragraph shall no longer apply to that Dispute and a Dispute Party may refer the matter to the Authority or to arbitration as appropriate in accordance with paragraphs 4 and 5 below.

4. REFERRALS TO THE AUTHORITY

4.1 Subject to paragraph 3, a Party may refer a Dispute falling under sub-paragraphs 4.3 or 4.4 or an Implementation Dispute under paragraph 4.6 to the Authority for determination by issuing a Reference Notice to the Authority copied to each of the other Dispute Parties.

- 4.2 Subject to paragraph 4.5 below, any Dispute falling under this paragraph 4 shall not be capable of being referred to arbitration pursuant to the rules of the Electricity Arbitration Association or otherwise, or to any court.
- 4.3 In addition to those matters falling under paragraph 4.4, the following matters shall constitute a Dispute referable to the Authority under the Code:
- 4.3.1 a failure to agree pursuant to Section A, paragraph 4.4;
 - 4.3.2 a failure to agree pursuant to Section B, sub-paragraph 3.2.5 or any other dispute in relation to the scope, content or performance of the Party Entry Processes;
 - 4.3.3 a failure to agree pursuant to Section B, sub-paragraph 5.1.6 or any other dispute in relation to the scope, content or performance of the Decommissioning Actions;
 - 4.3.4 a failure to agree pursuant to Section B, sub-paragraph 7.3.4;
 - 4.3.5 a failure to agree an amendment to the form of the Services Capability Specification pursuant to Section C, Part One, paragraphs 3.2 or 3.3;
 - 4.3.6 a dispute in relation to the reasonableness of a request for further information by The Company pursuant to Section C, Part One, paragraph 3.4;
 - 4.3.7 a dispute in relation to the net costs reasonably incurred by the Transmission Owner as a result of an Outage Change (as defined in the licence);
 - 4.3.8 a dispute in relation to the provision of, or failure to provide, training pursuant to Section C, Part Three, paragraph 7.3;
 - 4.3.9 a failure to agree a National Electricity Transmission Performance Report Timetable or any part thereof pursuant to Section C, Part Three, paragraph 8.3;
 - 4.3.10 a failure to agree amendments to draft text of a National Electricity Transmission System Performance Report pursuant to Section C, Part Three, paragraph 8.5;
 - 4.3.11 a failure to agree a SYS Programme or any part thereof pursuant to Section D, Part One, sub-paragraph 4.1.2;
 - 4.3.12 a failure to agree amendments to draft text of a Seven Year Statement pursuant to Section D, Part One, sub-paragraph 4.1.4;
 - 4.3.13 a failure to agree an ODIS Programme or any part thereof pursuant to Section D, Part One, sub-paragraph 5.1.2;
 - 4.3.14 a failure to agree amendments to the draft text of an Offshore Development Information Statement pursuant to Section D, Part One, sub-paragraph 5.1.4;
 - 4.3.15 a dispute pursuant to Section E, paragraph 5.1;
 - 4.3.16 a failure to agree under Section G, sub-paragraphs 6.1.1 or 6.1.2; and

- 4.3.17 a dispute as to whether a matter falling under paragraph 4.4 materially and adversely affects a Dispute Party's ability to develop and maintain an efficient, co-ordinated and economical system of electricity in the National Electricity Transmission System Operator Area for the purpose of determining such Dispute Party's entitlement to refer a matter to the Authority under paragraph 4.4.
- 4.4 In addition to those matters falling under paragraph 4.3, the following matters shall constitute a Dispute referable to the Authority by a Dispute Party under the Code only where such matter(s) materially adversely affect(s) that Dispute Party's ability to develop and maintain an efficient, co-ordinated and economical system of electricity transmission in the National Electricity Transmission System Operator Area:
- 4.4.1 a failure to agree a Services Restoration Proposal or any modification to a Services Restoration Proposal under Section C, Part One, paragraphs 4.7 and 4.8 or 4.9;
- 4.4.2 a dispute in relation to either a request by The Company or the adequacy of preparatory steps taken by a Transmission Owner pursuant to Section C, Part One, paragraph 4.13;
- 4.4.3 a dispute in relation to the manner in which matters contained in an Outage Proposal are included, or are not included, in an Outage Plan pursuant to Section C, Part Two, paragraph 2.4;
- 4.4.4 a failure to agree in relation to any Outage Plan or Outages Implementation Process pursuant to Section C, Part Two, paragraphs 5.7, 6.1 or 6.5;
- 4.4.5 a dispute in relation to a direction issued by The Company regarding discontinuation of an Outage or Outages pursuant to Section C, Part Two, paragraph 7.1;
- 4.4.6 a dispute in relation to a request for a change to Planning Assumptions pursuant to Section D, Part One, paragraph 2.2;
- 4.4.7 a dispute in relation to a Planning Request pursuant to Section D, Part One, sub-paragraph 2.4.4;
- 4.4.8 a dispute in relation to the reasonableness of a request by The Company for information pursuant to Section D, Part One, sub-paragraph 2.6.2;
- 4.4.9 a dispute in relation to a Transmission Interface Site Specification pursuant to Section D, Part One, sub-paragraph 2.7.4;
- 4.4.10 a dispute in relation to a Embedded Transmission Interface Site Specification pursuant to Section D, Part One, sub-paragraph 2.8.3;
- 4.4.11 a dispute in relation to the effectiveness of a The Company Construction Application pursuant to Section D, Part Two, paragraph 2.5;

- 4.4.12 a dispute in relation to a request for a change to Construction Planning Assumptions pursuant to Section D, Part Two, paragraph 3.7;
 - 4.4.13 a dispute in relation to a notice by the Transmission Owner that it does not intend to submit a TO Construction Offer or a notice of any assumptions which a Transmission Owner intends to make in relation to User Equipment at a Relevant Connection Site pursuant to Section D, Part Two, paragraph 4.3;
 - 4.4.14 a dispute in connection with a TO Construction Offer or an OTSDUW Completion Report (including any documents included within it) pursuant to Section D, Part Two, paragraph 5.2;
 - 4.4.15 a failure to agree Communications Plant under Section D, Part Two, paragraph 9.1;
 - 4.4.16 a dispute in relation to the effectiveness of a The Company TEC Exchange Rate Application pursuant to Section D, Part Three, paragraph 1.4;
 - 4.4.17 a dispute in relation to a request for a change to TEC Exchange Planning Assumptions pursuant to section D, Part Three, paragraph 2.7;
 - 4.4.18 a dispute in relation to the effectiveness of The Company Request for a Statement of Works pursuant to Section D, Part Four, paragraph 1.4;
 - 4.4.19 a dispute in relation to a request for a change to Statement of Works Planning Assumptions pursuant to Section D, Part Four, paragraph 2.7; and
 - 4.4.20 a dispute in relation to a TO Statement of Works Notice by the Transmission Owner that it does not require Transmission Construction Works to be undertaken in respect of a Statement of Works Project or of any assumptions which a Transmission Owner intends to make in relation to User Equipment at a Relevant Connection Site pursuant to Section D, Part Four, paragraph 3.3.
- 4.5 The Authority's determination of a Dispute pursuant to this paragraph 4 shall, without prejudice to any ability to apply for judicial review of any determination, be final and binding on the Dispute Parties.
- 4.6 It is expected that, in most cases, the Authority's determination of a Dispute pursuant to this paragraph 4 will set out the effect of the determination in terms of any actions or other steps that the Dispute Parties should take. To the extent that there is a Dispute between the Dispute Parties over the implementation of any such determination by the Authority (an "**Implementation Dispute**"), then any such Dispute Party may, subject again to the obligation to hold initial discussions in the same terms as under paragraph 3.3, refer the Implementation Dispute back to the Authority for determination.
- 4.7 Following a determination under this paragraph 4, each Dispute Party shall take such steps as are required to give full and timely effect to that determination including, without

limitation, issuing, withdrawing or modifying any document, notice, plan or process or taking any other steps required pursuant to this Code.

5. REFERRALS TO ARBITRATION

5.1 Subject to paragraph 3, a Dispute Party may, unless otherwise specified in this Code, refer:

5.1.1 a Dispute that is specifically designated for referral to arbitration under this Code;
or

5.1.2 any other Dispute not referable to the Authority under paragraph 4.1,

to arbitration pursuant to the applicable rules of the Electricity Arbitration Association in force from time to time by issuing a Reference Notice to the Electricity Arbitration Association and to each of the other Dispute Parties and the Authority.

5.2 Whatever the nationality, residence or domicile of any Dispute Party and wherever the Dispute arose, the law of England shall be the proper law of reference to arbitration under this paragraph 5 and, in particular (but not so as to derogate from the generality of the foregoing), the provisions of the Arbitration Act 1996 shall apply to any such arbitration wherever it or any part of it shall be conducted save as prescribed below.

5.3 Subject to paragraph 5.4 the Parties hereby consent to the President of the Electricity Arbitration Association deciding at their discretion and ensuring, so far as practicable, that the proceedings relating to such a decision are managed effectively, fairly and expeditiously:

5.3.1 following the same process as set out in Article 13 of the Electricity Arbitration Association rules in respect of pending arbitrations, that two or more disputes referred to it for arbitration (whether pending or underway), be consolidated or otherwise heard together (whether or not such disputes are all Disputes or a Dispute and any dispute(s) referred under an Other Code), where a Party (or Other Code Party to a dispute under an Other Code) so requests in writing to the Electricity Arbitration Association copied to each of the other Parties and relevant Other Code Parties setting out the reasons for such consolidation; or

5.3.2 that a dispute referred to it (whether pending or underway and whether a Dispute or a dispute referred to it under an Other Code) be stayed for a period not exceeding three months after the referral of such dispute to the Electricity Arbitration Association, pending resolution of another dispute referred to it (whether pending or underway and whether a Dispute or a dispute referred under an Other Code).

- 5.4 The consent of the Parties under paragraph 5.3.1 shall be deemed not to have been given where a request for consolidation thereunder is received by the Electricity Arbitration Association more than three months (or such other period as the Electricity Arbitration Association may at its discretion determine) after the referral of any Dispute or Other Code dispute to the Electricity Arbitration Association which is the subject of such request.
- 5.5 Any arbitrator or panel of arbitrators appointed by the Electricity Arbitration Association rules under this paragraph 5 shall determine such issues as are referred to them consistently with any determination by the Authority of a Dispute under paragraph 4, whether or not relating to the same or different facts.
- 5.6 The arbitrator of a Dispute under this paragraph 5 may order that the arbitration be stayed pending approval of a proposal to amend the Code under the STC Modification Procedures by the Authority.
- 5.7 Subject to any order of the arbitrator, the Dispute Parties shall keep confidential and not use for any collateral or ulterior purpose the subject matter of the arbitration and all information, documents and materials produced for, or arising in relation to the arbitration including any relief granted save insofar as is necessary to enforce any such relief.
- 5.8 The arbitrator may make any award concerning the costs of the parties or the costs of the arbitration as they consider appropriate.
- 5.9 The determination of an arbitrator under this paragraph 5 shall be final and binding on the Dispute Parties.
- 5.10 Following a determination under this paragraph 5, each Dispute Party shall take such steps as are required to give effect to that determination including, without limitation, under this Code.

SECTION I: TRANSITION

PART 1: BETTA TRANSITION

1. INTRODUCTION

1.1 This Section I Part 1 sets out various steps and processes which shall be undertaken by the Parties during the Transition Period to develop and otherwise prepare for those matters under the Code which will take effect on and from the Go Live Date, including:

1.1.1 development of a Transitional Services Capability Specification, Transitional Outage Plans, Transitional Outage Proposals, Transitional Investment Plans, Transitional NGET Investment Plans and the Transitional Connection Site Specification; and

1.1.2 provision for the co-ordinated development of Current User Offers and New Transitional Offers by Transmission Owners in accordance with an Agreed Transitional Timetable.

1.2 This Section I Part 1 also sets out various steps and processes which shall be undertaken by the Parties on and after Go Live date to the extent necessary for the purposes of, in the case of NGET, Standard Condition C18 of its Transmission Licence and, in the case of each Transmission Owner, Standard Condition D15 of its Transmission Licence.

1.3 References in this Section I Part 1 to NGET may relate to the role of NGESO as carried out by NGET at the time before the separation of NGESO from NGET and this section shall be construed as such.

2. PROVISIONS OF THE CODE NOT IN EFFECT DURING THE TRANSITION PERIOD

2.1 The provisions of the Code set out in paragraph 2.2 of this Section I, Part 1 shall not have effect until the Go Live Date. For the avoidance of doubt, all other provisions of the Code shall have effect on and from the Code Effective Date.

2.2 The provisions of the Code that shall not take effect pursuant to paragraph 2.1 are:

2.2.1 Section C;

2.2.2 Section D;

2.2.3 Section G, paragraphs 2.2 and 3; and

2.2.4 Section H.

3. GENERAL PROVISIONS

3.1 Subject to any express provision of this Section I Part 1, each Party shall discharge its obligations:

- 3.1.1 under paragraphs 8 and 9 of this Section I Part 1 consistently with its obligations under, in the case of NGET, Standard Condition C18 of its Transmission Licence and, in the case of each Transmission Owner, Standard Condition D15 of its Transmission Licence;
- 3.1.2 under each other paragraph of this Section I Part 1, taking into account and consistent with those obligations which it is, at the relevant time, known (or reasonably anticipated) are to be imposed on the licensee on and from the Go Live Date under such Party's Licence.
- 3.2 In addition to any other obligation to provide or exchange information under this Section I Part 1, each Party shall Disclose such information or data to other Parties during the Transition Period as the Authority may from time to time direct.
- 3.3 A Party may agree with any other Party that information or data which would otherwise be required to be provided under this Section I Part 1 is not required to be so provided (for example, because such information or data has already been provided or is already held by such other Party).

4. TRANSITIONAL PROVISIONS IN RELATION TO SECTION C, PART ONE

- 4.1 Each Transmission Owner shall separately agree the form of specification with NGET for the purposes of this paragraph 4 by 31 October 2004 (referred to as a “**Transitional Services Capability Specification**”).
- 4.2 Each Transmission Owner shall have by 30 November 2004 and shall maintain from that date throughout the Transition Period its Transitional Services Capability Specification so that it is as full and complete as reasonably practicable and describes such Transmission Owner's best estimate of the parameters and levels (which parameters and levels shall reflect its transmission planning) within and to which it will be capable of providing Transmission Services to NGET at the Go Live Date: such information to include and identify, without limitation, those technical limits that will apply as Normal Capability Limits pursuant to paragraph Section C, Part One, sub-paragraph 3.1.1 on and from the Go Live Date.
- 4.3 Each Transmission Owner shall submit a copy of its Transitional Services Capability Specification to NGET by 30 November 2004 and shall, from that date throughout the Transition Period, immediately submit to NGET copies of any amendments made to it under paragraph 4.4.
- 4.4 NGET and a Transmission Owner may agree that the Transmission Owner shall amend its Transitional Services Capability Schedule from time to time during the Transition Period to include such other information as may be reasonably requested by NGET.
- 4.5 NGET and a Transmission Owner may, at any time during the Transition Period, agree a change to the form or content of such Transmission Owner's Transitional Services Capability Schedule.

- 4.6 At the Go Live Date, the Transitional Services Capability Specification that each Transmission Owner has maintained pursuant to this paragraph 4 shall be deemed to be the Services Capability Specification of such Transmission Owner for the purposes of Section C, Part One, paragraph 3.

5. TRANSITIONAL PROVISIONS IN RELATION TO SECTION C, PART TWO

5.1 Transitional Outage Plan

- 5.1.1 NGET shall develop by 30 November 2004 and maintain from that date throughout the Transition Period a separate plan for each of the 7 Financial Years immediately following the Financial Year ending 31 March 2005 (each plan being referred to as a “**Transitional Outage Plan**”) for the placement of Outages on the GB Transmission System and shall:

5.1.1.1 keep up-to-date and refine its Transitional Outage Plans during the Transition Period to reflect the best and most current information available to it; and

5.1.1.2 provide each Transmission Owner with the most up-to-date version of those parts of each Transitional Outage Plan as contain or relate to Outages of, or any other Outages which are likely to materially affect such Transmission Owner's Transmission System.

- 5.1.2 Each of the Transitional Outage Plans developed by NGET pursuant to subparagraph 5.1.1 shall contain those matters set out in Section C, Part Two, paragraph 2.2.

- 5.1.3 In the course of developing its Transitional Outage Plans, NGET shall, to the extent that it is reasonable and practicable to do so:

5.1.3.1 consult with the Transmission Owners and keep them informed of any current or proposed matters which may give rise to or affect Outages of each Transmission Owner's Transmission System; and

5.1.3.2 take into account each Transitional Outage Proposal in the preparation of its Transitional Outage Plan for the relevant Financial Year.

- 5.1.4 Each Transmission Owner shall co-operate and assist NGET in developing NGET's Transitional Outage Plans, including by:

5.1.4.1 developing and maintaining, in accordance with paragraph 5.2, that Transmission Owner's Transitional Outage Proposals with the objective of providing NGET with a proposed placement of Outages for each Financial Year that facilitates the most efficient, co-ordinated and economical placement of Outages on the GB Transmission System as is reasonably foreseeable and practicable, given the information available to such Transmission Owner; and

5.1.4.2 providing NGET with the most up-to-date version of each of its Transitional Outage Proposals.

5.2 **Transitional Outages Proposals**

- 5.2.1 Each Transmission Owner shall develop by 31 October 2004 a separate Outage Proposal in respect of each of the seven Financial Years immediately following the current Financial Year ending 31 March 2005 (each a “**Transitional Outage Proposal**”) and shall maintain from that date throughout the Transition Period the Transitional Outage Proposals for each of the six Financial Years immediately following the Financial Year ending March 2006.
- 5.2.2 The Transitional Outage Proposals of each Transmission Owner shall contain those matters set out in Section C, Part Two, paragraph 3.2.
- 5.2.3 The Transitional Outage Proposal provided by each Transmission Owner pursuant to sub-paragraph 5.1.4.2 in respect of the Financial Year ending 31 March 2006 shall be the final version of such Transitional Outage Proposal and each Transmission Owner shall ensure that it is as full and complete as reasonably practicable.

5.3 **Changes to the Transitional Outage Plan for the Financial Year ending 31 March 2006**

- 5.3.1 As soon as a Party becomes aware, during the Transition Period, that a change is required to the Transitional Outage Plan for the Financial Year ending 31 March 2006, including any requirement for a further Outage or changes to the scheduled dates or times for, or cancellation of, an existing Outage, that Party:
 - 5.3.1.1 if it is a Transmission Owner, shall request a change to such Transitional Outage Plan to NGET, including with such request a brief description of the reason(s) for the change; or
 - 5.3.1.2 if it is NGET, notify each Transmission Owner that NGET itself requests or another Transmission Owner has requested (where it has received a request under sub-paragraph 5.3.1.1) a change to the Transitional Outage Plan to the extent that it considers that such change affects Outages of, or any other Outages which are likely to materially affect, that Transmission Owner’s Transmission System, with a brief description of the reason(s) for the change.
- 5.3.2 Following a request to change a Transitional Outage Plan made pursuant to 5.3.1, the Party requesting such change, NGET and any Transmission Owners which receive notification pursuant to sub-paragraph 5.3.1.2 shall agree how the change may be accommodated.
- 5.3.3 During the Transition Period, each Party shall discuss and exchange relevant information with each other Party to the extent that such information is likely to have a material effect on the Outages of such other Party.

- 5.3.4 Each Transmission Owner shall develop its Transitional Outage Proposals taking into account, to the extent that it is reasonable and practical to do so, the activities and reasonable requests of each other Party and the information provided to it under this Code.
- 5.3.5 Where it is reasonably prudent to do so, the Parties shall jointly prepare during the Transition Period for the implementation of any Outages which are planned to occur during the Financial Year ending 31 March 2006.
- 5.3.6 At the Go Live Date:
- 5.3.6.1 the Transitional Outage Plans developed by NGET pursuant to paragraph 5.1 shall be deemed to be the initial Outage Plans for the purposes of Section C, Part Two, paragraph 2.1;
- 5.3.6.2 the Transitional Outage Proposals developed by each Transmission Owner pursuant to paragraph 5.2 shall be deemed to be the initial Outage Proposals of that Transmission Owner for the purposes of Section C, Part Two, paragraph 3.1; and
- 5.3.6.3 any process or associated configuration of the GB Transmission System required for the implementation of an Outage and developed pursuant to sub-paragraph 5.3.5 shall be deemed to be the Outage Implementation Process for such Outage for the purposes of Section C, Part Two, paragraph 6.1.

6. TRANSITIONAL PROVISIONS IN RELATION TO SECTION C, PART THREE

6.1 Interface Agreements

- 6.1.1 Each Transmission Owner shall advise NGET as soon as reasonably practicable and in any event by 1 December 2004 whether an Interface Agreement is required in relation to each Connection Site and New Connection Site located on their Transmission System.
- 6.1.2 Where a Transmission Owner identifies that an Interface Agreement is required pursuant to sub-paragraph 6.1.1, it shall promptly enter into an Interface Agreement with the relevant User in a form to be agreed between them, but based substantially in the form set out in Exhibit O, Part B to the CUSC.

6.2 Black Start

- 6.2.1 On or before 31 March 2005, the Parties shall have in place a Code Procedure setting out the information and assistance required by Transmission Owners so that NGET can implement a Black Start.

7. TRANSITIONAL PROVISIONS IN RELATION TO SECTION D, PART ONE

7.1 Transmission Owner's Transitional Investment Plans

- 7.1.1 Each Transmission Owner shall develop by 31 October 2004 and then maintain from that date throughout the Transition Period a separate plan in respect of each of the seven Financial Years immediately following the Financial Year ending on 31 March 2005 (each plan referred to as a “**Transitional Investment Plan**”) and shall keep up-to-date and refine its Transitional Investment Plans during this period to reflect the best and most current information available to it.
- 7.1.2 Each Transitional Investment Plan shall contain, to the extent and in such detail as is reasonably practicable and appropriate at the time, for the relevant Financial Year, those matters set out in Section D, Part One, sub-paragraph 2.1.2.
- 7.1.3 Each Transmission Owner shall ensure, to the extent that it is reasonable and appropriate to do so, that from 31 October 2004 throughout the Transition Period:
 - 7.1.3.1 NGET is provided with the most up-to-date versions of its Transitional Investment Plans; and
 - 7.1.3.2 each other Transmission Owner is provided with such parts of the up-to-date versions of its Transitional Investment Plans as may have a material effect upon that other Transmission Owner’s Transitional Investment Plans.

7.2 **NGET's Transitional NGET Investment Plans**

- 7.2.1 NGET shall develop by 31 October 2004 and then maintain from that date throughout the Transition Period separate plans in respect of each of the seven Financial Years immediately following the Financial Year ending on 31 March 2005 (each plan referred to as a “**Transitional NGET Investment Plan**”) for those proposed Changes to its Transmission System which are likely to have a material effect upon any of the Transmission Owners’ Transitional Investment Plans and NGET shall keep up-to-date and refine its Transitional NGET Investment Plans during this period to reflect the best and most current information available to it.
- 7.2.2 Each Transitional NGET Investment Plan shall contain, to the extent and in such detail as is reasonably practicable and appropriate at the time, for the relevant Financial Year, the same matters in relation to NGET as are required to be set out in relation to Transmission Owners in their Transitional Investment Plans under sub-paragraph 7.1.2.
- 7.2.3 NGET shall ensure, to the extent that it is reasonable and appropriate to do so, that from 31 October 2004 throughout the Transition Period each Transmission Owner is provided with such parts of its up-to-date Transitional NGET Investment Plans as may have a material effect upon that Transmission Owner’s Transitional Investment Plans.

7.3 **Transitional Planning Assumptions**

- 7.3.1 NGET shall prepare Planning Assumptions on a GB-wide basis during the Transition Period ("**Transitional Planning Assumptions**") and shall as soon as reasonably practicable and, in any event, on or before 30 September 2004, provide such Transitional Planning Assumptions to Transmission Owners (and then as updated or modified from time to time) to be used by them in planning and developing their Transmission Systems in accordance with this Section I Part 1.
- 7.3.2 A Transmission Owner may at any time submit a request to NGET for a change to Transitional Planning Assumptions it has received pursuant to sub-paragraph 7.3.1, provided that such request shall contain a description (in reasonable but not excessive detail) of the reason(s) for the request.
- 7.3.3 If NGET receives a request for a change to Transitional Planning Assumptions pursuant to sub-paragraph 7.3.2 it shall, as soon as reasonably practicable:
- 7.3.3.1 notify the Transmission Owner submitting the request and any other Transmission Owner which is likely to be materially affected by the requested change whether or not and, where relevant, how NGET intends to accommodate such request; and
- 7.3.3.2 where relevant, change and re-issue such Transitional Planning Assumptions accordingly.
- 7.3.4 In planning its Transmission System during the Transition Period, each Transmission Owner shall do so in accordance with the obligations which will apply to planning and development on and from the Go Live Date under Section D, Part One, paragraph 2.2, except that references to:
- 7.3.4.1 "Planning Assumptions" shall be taken to be references to Transitional Planning Assumptions provided to it by NGET pursuant to sub-paragraph 7.3.1;
- 7.3.4.2 "Connection Site Specification" shall be taken to be references to the Transitional Connection Site Specification; and
- 7.3.4.3 "Licence Standards" shall be taken to be references to those obligations which are imposed on the Transmission Owner during the Transition Period by Standard Condition D3 of such Transmission Owner's Transmission Licence or which it is, at the relevant time, known (or reasonably anticipated) are to be imposed on the Transmission Owner on and from the Go Live Date.

7.4 **Co-ordination of and Changes to Transitional Investment Planning**

- 7.4.1 During the Transition Period, the Parties shall:

7.4.1.1 co-operate and assist each other in the development of co-ordinated Transitional Investment Plans and Transitional NGET Investment Plans; and

7.4.1.2 plan, for the purposes of this paragraph 7, their Transmission Systems taking into account, to the extent that it is reasonable and practicable to do so, the activities and reasonable requests of each other Party relating to the planning and development of such other Parties' Transmission Systems.

7.4.2 A Party may, at any time during the Transition Period, request a change to such parts as it has been provided with pursuant to sub-paragraphs 7.1.3 or 7.2.3 of, in the case where such other Party is a Transmission Owner, that other Party's Transitional Investment Plan(s) or, in the case where such other Party is NGET, any Transitional NGET Investment Plan(s).

7.4.3 At the Go Live Date:

7.4.3.1 the Transitional Investment Plans developed by each Transmission Owner pursuant to paragraph 7.1 shall be deemed to be the initial Transmission Investment Plans of that Transmission Owner for the purposes of Section D, Part One, sub-paragraph 2.1.1;

7.4.3.2 the Transitional NGET Investment Plans developed by NGET pursuant to paragraph 7.2 shall be deemed to be the initial NGET Investment Plans of NGET for the purposes of Section D, Part One, sub-paragraph 2.1.4; and

7.4.3.3 the Transitional Planning Assumptions prepared by NGET pursuant to sub-paragraph 7.3.1 (as changed during the Transition Period) shall be deemed to be the initial Planning Assumptions for the purposes of Section D, Part One, paragraph 2.2.

7.4.4 Each Transmission Owner shall co-operate and assist NGET during the Transition Period in the development by NGET of the Interim Seven Year Statement and Seven Year Statement including, without limitation, by promptly complying with any reasonable request from NGET for information or such co-operation or assistance.

8. TRANSITIONAL PROVISIONS IN RELATION TO CURRENT USERS

8.1 Transitional Connection Site Specification

8.1.1 Each Transmission Owner shall submit to NGET by 5 September 2004, or such other date as the Transmission Owner and NGET shall agree, a specification setting out the Transmission Owner Connection Assets forming part of such Transmission Owner's Transmission System and any User Equipment connected to or associated with such Transmission Owner Connection Assets as at 1 September 2004 ("**Transitional Connection Site Specification**").

- 8.1.2 Each Transmission Owner shall keep under review and update its Transitional Connection Site Specification during the Transition Period so that it contains, without limitation, information of the same kind and in substantially the same detail as set out in relation to Transmission Connection Assets and User Equipment in any bilateral agreements entered into between such Transmission Owner and Users at any time up to the Go Live Date.
- 8.1.3 At the same time as it submits its Transitional Connection Site Specification, or any update made pursuant to sub-paragraph 8.1.2, to NGET, each Transmission Owner shall also provide the following information in respect of each Connection Site (to the extent such information does not already form part of the Transitional Connection Site Specification):
- 8.1.3.1 the date on which the User entered into a bilateral agreement with the Transmission Owner in respect of such Connection Site (where applicable); and
- 8.1.3.2 any other information reasonably requested by NGET in relation to such User or Connection Site including, without limitation, information required to enable NGET to determine the Transmission Entry Capacity and Connection Entry Capacity of such Connection Site.
- 8.1.4 At the Go Live Date the Transitional Connection Site Specification developed by each Transmission Owner pursuant to sub-paragraph 8.1.1 (as modified or updated during the Transition Period pursuant to sub-paragraphs 8.1.2 or 8.1.3) shall be deemed to be the initial Connection Site Specification.

8.2. **Current User Applications**

- 8.2.1 For the purposes of this Section I Part 1, a "**Current User**" is a User which, as at 1 January 2005:
- 8.2.1.1 is a party to an agreement (including, without limitation, any party that has accepted an offer prior to 1 January 2005) with NGET or a Transmission Owner for connection or use of system; or
- 8.2.1.2 has otherwise submitted an application for connection or use of system to NGET or a Transmission Owner (including without limitation any application in relation to which NGET or a Transmission Owner has submitted an offer prior to 1 January 2005).
- 8.2.2 In accordance with the Agreed Transitional Timetable (referred to in paragraph 10.1) and, except to the extent otherwise agreed between NGET and the relevant Transmission Owner, prior to 5 January 2005, each Transmission Owner shall notify NGET of:
- 8.2.2.1 each Current User who has an agreement for connection to or use of such Transmission Owner's Transmission System;

- 8.2.2.2 any applications made by a Current User to the Transmission Owner at any time prior to 1 January 2005 in relation to a Connection Site (including any application for use of system) and in respect of which the Transmission Owner has not provided a relevant offer to such Current User and shall provide NGET with a complete copy of any such application; and
- 8.2.2.3 any offers which have been provided to a Current User by the Transmission Owner at any time before 1 January 2005 in relation to a Connection Site (including any offer for use of system) and which have not been accepted by such Current User.
- 8.2.3 At any time prior to 7 January 2005, NGET may submit an application (a "**Current User Application**") to a Transmission Owner, in accordance with the Agreed Transitional Timetable (referred to in paragraph 10.1), in respect of:
 - 8.2.3.1 any current Connection Site of a Current User, or any proposed Connection Site in respect of which an application has been submitted to a Party by a User prior to 1 January 2005, which is located on such Transmission Owner's Transmission System; and
 - 8.2.3.2 any other Connection Site of a Current User in respect of which an application has been submitted to a Party by a User prior to 1 January 2005 and which NGET reasonably considers is likely to materially affect the first Transmission Owner's Transmission System, taking into account the criteria referred to in paragraph 11.
- 8.2.4 NGET may, if it reasonably considers that it is appropriate or expedient to do so, submit a Current User Application pursuant to sub-paragraph 8.2.3 to a Transmission Owner in respect of more than one Connection Site.
- 8.2.5 A Current User Application submitted pursuant to sub-paragraph 8.2.3 shall contain the information reasonably necessary in order to enable each Transmission Owner, following receipt of Transitional Construction Planning Assumptions pursuant to paragraph 8.3, to:
 - 8.2.5.1 identify whether construction works would be required in respect of each Connection Site identified in such Current User Application; and
 - 8.2.5.2 where relevant, prepare a Current User Offer pursuant to sub-paragraph 8.4 in respect of such Connection Site(s).
- 8.2.6 A Current User Application submitted pursuant to sub-paragraph 8.2.3 shall be deemed to be effective from the date on which it is received by the relevant Transmission Owner.

8.3 **Transitional Construction Planning Assumptions**

- 8.3.1 In addition to the Transitional Planning Assumptions and, Planning Assumptions used for general transmission planning, NGET may generate a set of Planning Assumptions which takes into account the power flows which NGET anticipates might be associated with a Current User Application for use only in the preparation by the relevant Transmission Owner(s) of the corresponding Current User Offer(s) ("**Transitional Construction Planning Assumptions**").
- 8.3.2 NGET shall notify each Transmission Owner as soon as reasonably practicable if it does not intend to generate a set of Transitional Construction Planning Assumptions in respect of a Current User Application, following which the general Transitional Planning Assumptions provided to Transmission Owners pursuant to sub-paragraph 7.3.1 of this Section I Part 1 shall be deemed to be Transitional Construction Planning Assumptions for the purposes of this paragraph 8.
- 8.3.3 A Transmission Owner may at any time submit a request to NGET for a change to Transitional Construction Planning Assumptions it has received pursuant to sub-paragraph 8.3.1 or which have been deemed pursuant to sub-paragraph 8.3.2, provided that such request shall contain a description (in reasonable but not excessive detail) of the reason(s) for the request.
- 8.3.4 If NGET receives a request for a change to Transitional Construction Planning Assumptions pursuant to sub-paragraph 8.3.3 it shall, as soon as reasonably practicable notify the Transmission Owner submitting the request and any other Transmission Owner which is likely to be materially affected by the requested change whether or not and, where relevant, how NGET intends to accommodate such request.
- 8.3.5 NGET may, in its discretion, change a set of Transitional Construction Planning Assumptions (including any deemed Transitional Construction Planning Assumptions under sub-paragraph 8.3.2), at any time up to the time at which it accepts the Current User Offer to which such Construction Planning Assumptions apply by giving notice to the relevant Transmission Owner(s).
- 8.3.6 If NGET generates, modifies or updates Transitional Construction Planning Assumptions, it shall do so, and shall provide any relevant parts of such Transitional Construction Planning Assumptions to Transmission Owners, in accordance with the Agreed Transitional Timetable (referred to in paragraph 10.1).

8.4. **Current User Offers**

- 8.4.1 Each Transmission Owner shall notify NGET as soon as reasonably practicable following receipt of a Current User Application and, in any event, in accordance with the Agreed Transitional Timetable (referred to in paragraph 10.1), whether or not such Transmission Owner intends to submit an offer in respect of such Current User Application ("**Current User Offer**") to NGET pursuant to this paragraph 8.4 in respect of any Connection Site(s) identified in such Current User Application including, without limitation, where the Transmission Owner is

not submitting a Current User Offer because it is not obliged to do so pursuant to Standard Condition D15 of its Transmission Licence or the Act.

- 8.4.2 A Transmission Owner may, where it has agreed to do so with NGET, submit a Current User Offer in accordance with this paragraph 8.4 in respect of one or more Connection Sites notwithstanding that NGET has not submitted a Current User Application in respect of such Connection Site(s).
- 8.4.3 Where a Transmission Owner does not require Transmission Construction Works to be undertaken in respect of a Current User Application or where it otherwise notifies NGET under paragraph 8.4.1 that it will not be submitting a Current User Offer, it shall not (subject to any contrary determination of the Authority) submit a Current User Offer to NGET in relation to such Current User Application.
- 8.4.4 Subject to Standard Condition D15 of its Transmission Licence, a Transmission Owner shall prepare Current User Offer(s) in accordance with the obligations which will apply to the preparation of TO Construction Offers on and from the Go Live Date under Section D, Part Two, paragraph 4, except that references to:
- 8.4.4.1 "TO Construction Offer" shall be taken to be references to Current User Offer;
- 8.4.4.2 "Part One, paragraph 2.2 of this Section D" shall be taken to be a reference to paragraph 7.3 of this Section I Part 1;
- 8.4.4.3 "NGET Construction Application" shall be taken to be a reference to Current User Application.
- 8.4.5 If a Transmission Owner is submitting a Current User Offer to NGET, it shall do so as soon as reasonably practicable and, in any event, in accordance with the Agreed Transitional Timetable.
- 8.4.6 For the avoidance of doubt, where a Current User Application is submitted by NGET in respect of more than one Connection Site pursuant to sub-paragraph 8.2.3, the applicable Current User Offer may, at the discretion of the relevant Transmission Owner, also apply to one or more of such Connection Site(s).
- 8.4.7 A Current User Offer submitted by a Transmission Owner to NGET pursuant to sub-paragraph 8.4.4 shall include, without limitation, those matters set out in Schedule Eight, paragraph 1.1 except that in relation to Current User Offers submitted before the Go Live Date:
- 8.4.7.1 references to "Transmission Services" and "Normal Capability Limits" shall be to those Transmission Services and Normal Capability Limits which reflect the Transmission Owner's transmission planning and which the relevant Transmission Owner reasonably anticipates it will provide or which will apply on and from the Go Live Date; and

8.4.7.2 references to “Construction Project” shall be to those construction works required in relation to the Connection Site(s) as set out in the Current User Offer.

8.4.8 Where a Current User Offer relates to more than one Connection Site, it may also contain one or more TO Construction Agreement(s), provided that:

8.4.8.1 all of the TO Construction Works identified in such Current User Offer are covered by TO Construction Agreement(s); and

8.4.8.2 all of the Works undertaken at an individual Connection Site are covered by only one TO Construction Agreement.

8.5 Acceptance of Current User Offer by NGET

8.5.1 A Current User Offer shall remain open for acceptance in accordance with the Agreed Transitional Timetable (referred to in paragraph 10.1) unless an application is made to the Authority under Standard Condition C18 of NGET's Transmission Licence, in which event such period shall remain subject to any determination by or other direction from the Authority.

8.5.2 In the event that NGET modifies Transitional Construction Planning Assumptions after a Transmission Owner has submitted its Current User Offer for the Construction Project to which such Transitional Construction Planning Assumptions apply, the Transmission Owner shall, as soon as reasonably practicable or otherwise within such timescales as shall be agreed between NGET and the Transmission Owner, revise and re-submit its Current User Offer to NGET, taking into account such modified Transitional Construction Planning Assumptions.

8.5.3 If NGET wishes to accept a Current User Offer, it shall do so by promptly notifying the relevant Transmission Owner in the form specified in such Current User Offer and by providing it with an executed copy or executed copies of the relevant TO Construction Agreement(s).

8.5.4 Following acceptance of a Current User Offer by NGET pursuant to subparagraph 8.5.3 the Transmission Owner shall construct the relevant Transmission Construction Works in accordance with the terms of this Code and the executed TO Construction Agreement(s).

9. TRANSITIONAL PROVISIONS IN RELATION TO NEW TRANSITIONAL APPLICATIONS DURING THE PERIOD FROM 1 JANUARY 2005 TO THE GO LIVE DATE

9.1 New Transitional Applications

9.1.1 Each Transmission Owner shall immediately forward to NGET a complete copy of any application received from a User in respect of a Connection Site (including

any application for use of system) during the period commencing on 1 January 2005 and ending on the Go Live Date.

- 9.1.2 NGET may submit an application (a "**New Transitional Application**"), in accordance with this paragraph 9 and the Agreed Transitional Timetable (referred to in paragraph 10.1), to:
 - 9.1.2.1 the Transmission Owner, if any, whose Transmission System is located at the Connection Site which is the subject of the relevant application or offer (the "**Transitional Connection Site**");
 - 9.1.2.2 any Transmission Owner in relation to whose Transmission System the Transitional Connection Site satisfies the criteria referred to in paragraph 11; and
 - 9.1.2.3 any Transmission Owner which does not receive a New Transitional Application pursuant to sub-paragraphs 9.1.2.1 or 9.1.2.2 above, but who otherwise receives New Construction Planning Assumptions pursuant to paragraph 9.2 in relation to the Transitional Connection Site.
- 9.1.3 A New Transitional Application submitted pursuant to sub-paragraph 9.1.2 shall contain the information reasonably necessary in order to enable each Transmission Owner to:
 - 9.1.3.1 identify whether construction works would be required in respect of the Connection Site which is the subject of such New Transitional Application; and
 - 9.1.3.2 where relevant, prepare a New Transitional Offer.
- 9.1.4 A New Transitional Application submitted pursuant to sub-paragraph 9.1.2 shall be deemed to be effective from the date on which it is received by the relevant Transmission Owner.
- 9.1.5 If a Transmission Owner reasonably considers that a New Transitional Application is not effective by reason of it not containing sufficient information, pursuant to sub-paragraph 9.1.3, to enable it to identify construction works or prepare a New Transitional Offer, it shall:
 - 9.1.5.1 as soon as reasonably practicable and in any event in accordance with the Agreed Transitional Timetable (referred to in paragraph 10.1), notify NGET of the further information or clarifications required; and
 - 9.1.5.2 otherwise use its best endeavours to liaise with and assist NGET (and, where requested by NGET, relevant third parties) so that the New Transitional Application is made effective as soon as reasonably practicable.

- 9.1.6 Each Transmission Owner shall charge NGET and NGET shall pay Engineering Charges in relation to a New Transitional Application in accordance with Schedule Ten.
- 9.1.7 NGET and each Transmission Owner shall keep each other informed of any changes in an application or any associated information provided by a User to either NGET or the relevant Transmission Owner and notice of any withdrawal by a User of an application which is the subject of a New Transitional Application shall also constitute notice of withdrawal by NGET of the relevant New Transitional Application from the time at which both NGET and the relevant Transmission Owner received notice of the User's withdrawal.

9.2 **Provision of New Construction Planning Assumptions**

- 9.2.1 In addition to the Transitional Planning Assumptions and Planning Assumptions used for general transmission planning, NGET may, as a consequence of a New Transitional Application, generate a set of Planning Assumptions which take into account the power flows which NGET expects may result from the Construction Project for use only in the preparation of Transitional New User Offers ("**New Construction Planning Assumptions**").
- 9.2.2 NGET shall notify each Transmission Owner as soon as reasonably practicable if it does not intend to generate a set of New Construction Planning Assumptions in respect of a New Transitional Application, following which the general Transitional Planning Assumptions provided to Transmission Owners pursuant to sub-paragraph 7.3.1 of this Section I Part 1 shall be deemed to be New Construction Planning Assumptions for the purposes of this Section I Part 1, paragraph 9.
- 9.2.3 A Transmission Owner may at any time submit a request to NGET for a change to New Construction Planning Assumptions it has received pursuant to sub-paragraph 9.2.1 or which have been deemed pursuant to sub-paragraph 9.2.2, provided that such request shall contain a description (in reasonable but not excessive detail) of the reason(s) for the request.
- 9.2.4 If NGET receives a request for a change to New Construction Planning Assumptions pursuant to sub-paragraph 9.2.3 it shall, as soon as reasonably practicable notify the Transmission Owner submitting the request and any other Transmission Owner which is likely to be materially affected by the requested change whether or not and, where relevant, how NGET intends to accommodate such request.
- 9.2.5 NGET may, in its discretion, change a set of New Construction Planning Assumptions (including any deemed New Construction Planning Assumptions under sub-paragraph 9.2.2), at any time up to the time at which it accepts the New Transitional Offer to which such New Construction Planning Assumptions apply by giving notice to the relevant Transmission Owner(s).

9.2.6 If NGET generates, modifies or updates New Construction Planning Assumptions, it shall do so, and shall submit any relevant parts of such New Construction Planning Assumptions to Transmission Owners, in accordance with the Agreed Transitional Timetable (referred to in paragraph 10.1).

9.3 **New Transitional Offers**

9.3.1 Each Transmission Owner shall notify NGET as soon as reasonably practicable and, in any event, in accordance with the Agreed Transitional Timetable (referred to in paragraph 10.1) following receipt of a New Transitional Application whether or not such Transmission Owner intends to submit a New Transitional Offer to NGET pursuant to this paragraph 9.3 in respect of any Connection Site identified in such New Transitional Application including, without limitation, where the Transmission Owner is not submitting a New Transitional Offer because it is not obliged to do so pursuant to Standard Condition D15 of its Transmission Licence or the Act.

9.3.2 Subject to Standard Condition D15 of its Transmission Licence, a Transmission Owner shall prepare New Transitional Offer(s) in accordance with the obligations which will apply to the preparation of TO Construction Offers on and from the Go Live Date under Section D, Part Two, paragraph 4, except that references to:

9.3.2.1 "TO Construction Offer" shall be taken to be references to New Transitional Offer;

9.3.2.2 "Part One, paragraph 2.2 of this Section D" shall be taken to be a reference to sub-paragraph 7.3.4 of this Section I Part 1; and

9.3.2.3 "NGET Construction Application" shall be taken to be a reference to New Transitional Application.

9.3.3 If a Transmission Owner is submitting a New Transitional Offer to NGET, it shall do so as soon as reasonably practicable and, in any event, in accordance with the Agreed Transitional Timetable (referred to in paragraph 10.1).

9.3.4 A New Transitional Offer submitted by a Transmission Owner to NGET pursuant to sub-paragraph 9.3.3 shall include, without limitation, those matters set out in Schedule Eight, paragraph 1.1 except that in relation to New Transitional Offers submitted before the Go Live Date:

9.3.4.1 references to "Transmission Services" and "Normal Capability Limits" shall be to those Transmission Services and Normal Capability Limits which reflect the Transmission Owner's transmission planning and which the relevant Transmission Owner reasonably anticipates it will provide or which will apply on and from the Go Live Date; and

9.3.4.2 references to "Construction Project" shall be to those construction works required in relation to the Connection Site(s) to facilitate the use of the

GB Transmission System by the relevant User(s) on and from the Go Live Date as set out in the New Transitional Offer.

9.4 **Acceptance of New Transitional Offer by NGET**

- 9.4.1 A New Transitional Offer shall remain open for acceptance in accordance with the Agreed Transitional Timetable (referred to in paragraph 10.1) unless an application is made to the Authority under Standard Condition C18 of NGET's Transmission Licence, in which event such period shall remain subject to any determination by or other direction from the Authority.
- 9.4.2 In the event that NGET modifies New Construction Planning Assumptions after a Transmission Owner has submitted its New Transitional Offer for the Construction Project to which such New Construction Planning Assumptions apply, the Transmission Owner shall, as soon as reasonably practicable, revise and re-submit its New Transitional Offer to NGET, taking into account such modified New Construction Planning Assumptions.
- 9.4.3 If NGET wishes to accept a New Transitional Offer, it shall do so by promptly notifying the relevant Transmission Owner in the form specified and by providing it with an executed copy or executed copies of the relevant TO Construction Agreement(s).
- 9.4.4 Following acceptance of a New Transitional Offer by NGET pursuant to sub-paragraph 9.4.3 the Transmission Owner shall, on and from the Go Live Date, construct the relevant Transmission Construction Works in accordance with the terms of this Code and the executed TO Construction Agreement.

10. **GENERAL PROVISIONS CONCERNING THE DEVELOPMENT OF CURRENT USER OFFERS AND NEW TRANSITIONAL OFFERS**

10.1 **Agreed Transitional Timetable**

10.1.1 The Parties shall agree a timetable (the "**Agreed Transitional Timetable**"), on or before 5 September 2004, which sets out those timeframes which are to apply between the Parties for the purposes of paragraphs 8 and 9 of this Section I Part 1, to the extent that such timeframes are not otherwise specified, and which includes, without limitation, provision for the submission or acceptance of:

- 10.1.1.1 Current User Applications pursuant to sub-paragraph 8.2.3;
- 10.1.1.2 Current User Offers pursuant to sub-paragraphs 8.4.1 or 8.5.1;
- 10.1.1.3 New Transitional Applications pursuant to sub-paragraphs 9.1.3, 9.1.6;
- 10.1.1.4 New Transitional Offers pursuant to sub-paragraph 9.3.2;
- 10.1.1.5 Transitional Construction Planning Assumptions pursuant to sub-paragraph 8.3.1 and

10.1.1.6 New Construction Planning Assumptions pursuant to subparagraph 9.2.1.

10.1.2 The Parties may agree to update or otherwise modify the Agreed Transitional Timetable at any time.

10.2 General Co-ordination of Construction Projects

10.2.1 The Parties shall, to the extent reasonably practicable, co-operate and assist each other in the preparation of Current User Offers and New Transitional Offers in the same manner and complying with the same requirements as shall apply in respect of TO Construction Offers on and from the Go Live Date pursuant to Section D, Part Two, paragraph 6.

11. CRITERIA FOR ASSESSING THOSE TRANSMISSION SYSTEMS AFFECTED BY APPLICATIONS DURING THE TRANSITION PERIOD

11.1 On or before 1 October 2004, the Parties shall agree and submit to the Authority for approval the proposed criteria for assessing those Transmission Systems affected by a Current User Application or New Transitional Application for the purposes of subparagraphs 8.2.3 and 9.1.3.

11.2 The criteria that apply for the purpose of assessing those Transmission Systems affected by a Current User Application or New Transitional Application shall be the criteria proposed by the Parties pursuant to paragraph 11.1 as amended or otherwise approved by the Authority.

12. SITE RESPONSIBILITY SCHEDULES

12.1 On or before 28 February 2005, each Transmission Owner shall complete, or procure from a User, a Site Responsibility Schedule in respect of each Connection Site located on its Transmission System and provide all such Site Responsibility Schedules to NGET.

12.2 Each Transmission Owner shall promptly provide to NGET a copy of any new or updated Site Responsibility Schedules completed or updated by itself or a User at any time after 28 February 2005 up to the Go Live Date.

12.3 NGET shall provide to each Transmission Owner any assistance which it reasonably requests from NGET in relation to the preparation of a Site Responsibility Schedule pursuant to this paragraph 12.

13. DISPUTES

13.1 Any matter arising between two or more Parties:

13.1.1 during the Transition Period, under the Code; and

13.1.2 on and from the Go Live Date, under paragraph 8, 9 and 10 of this Section I Part 1.

- 13.2 A Party may raise a Dispute by issuing a Transitional Dispute Notice to the Authority and each of the other Dispute Parties.
- 13.3 Unless otherwise specified in this Code or directed by the Authority, any specification, plan, proposal or other document developed or changed under this Section I Part 1 which is the subject of a Dispute shall be developed and, if relevant, implemented as proposed by the Party responsible for the initial development of such specification, plan, proposal or other document, subject to any subsequent determination of the Dispute by the Authority.
- 13.4 The Authority's determination of a Dispute under this paragraph 13 shall, without prejudice to any right to apply for judicial review of any determination, be final and binding on the Dispute Parties.
- 13.5 It is expected that, in most cases, the Authority's determination of a Dispute under this paragraph 13 will set out the effect of the determination in terms of any actions or other steps that the Dispute Parties should take. To the extent that there is a Dispute between the Dispute Parties over the implementation of any such determination by the Authority (a "**Transitional Implementation Dispute**"), then any such Dispute Party may refer the Transitional Implementation Dispute back to the Authority for determination.
- 13.6 Following a determination under this paragraph 13, each Dispute Party shall take such steps as are required to give full and timely effect to that determination including, without limitation, issuing, withdrawing or modifying any application, offer (including the terms of such application or offer), notice, plan or any other information or process or taking any other steps required pursuant to this Section I Part 1.

14. TRANSITIONAL PROVISIONS IN RELATION TO LARGE POWER STATIONS

- 14.1 Each Transmission Owner who has in force at 15 December 2004 an agreement for use of the Transmission Owner's transmission system with a person who owns or operates a Large Power Station other than a Large Power Station which is connected to a part of either a Distribution System that is not directly or indirectly connected to the GB Transmission System or a User System that is not directly or indirectly connected to the GB Transmission System, shall use its best endeavours to procure that such persons shall accede to the CUSC Framework Agreement.
- 14.2 In paragraph 14.1, "Large Power Station" and "User System" have the meanings given in the CUSC.

PART 2: STC MODIFICATION PROPOSAL [000] (Amendments relating to the transfer of the system operator functions from NGET)

1. INTRODUCTION

- 1.1 This Section I Part 2 deals with issues arising out of the transition associated with the approval and implementation of STC Modification Proposal [000] (Amendments relating to the transfer of the system operator functions from NGET to NGESO).
- 1.2 This Section I, Part 2 sets out the arrangements such that:
- 1.2.1 the rights and obligations of NGET under the STC that relate to the role of system operator are novated to NGESO;
 - 1.2.2 certain amendments are made to Existing STC Related Agreements;
 - 1.2.3 NGET is deemed to have followed the processes set out in Section B such that it becomes an Onshore Transmission Owner party under the STC; and
 - 1.2.4 each Party co-operates in relation to the transition.
- 1.3 The provisions of the Post STC [000] STC shall be suspended except for this Section I (which will take immediate effect) until the Transfer Date.
- 1.4 In this Section I, Part 2:
- 1.4.1 the term "STC [000]" shall mean STC Modification Proposal [000] (Amendments relating to the transfer of the system operator functions from NGET to NGESO);
 - 1.4.2 the term "Post STC [000] STC" means the version of the STC as amended by STC [000];
 - 1.4.3 the term "Pre STC [000] STC" means the version of the STC prior to amendment by STC [000];
 - 1.4.4 the term "Transfer Date" means the date on which the Transmission Licence granted to NGET is transferred in part to NGESO to reflect the transfer of the system operator functions.
- 1.5 Without prejudice to any specific provision under this Section I, Part 2 as to the time within which or the manner in which any Party should perform its obligations under this Section I Part 2 where a Party is required to take any step or measure under this Section I Part 2, such requirement shall be construed as including any obligation to:
- 1.5.1 take such step or measure as quickly as reasonably practicable; and
 - 1.5.2 do such associated or ancillary things as may be necessary to complete such step or measure as quickly as reasonably practicable.

2. STC [000]: NOVATION

- 2.1 This paragraph applies to facilitate the transfer of all NGET's rights and obligations under the STC that relate to its role as system operator to NGESO on the Transfer Date to reflect the transfer of the system operator functions from NGET to NGESO.
- 2.2 NGET and NGESO shall each enter into a novation agreement in a form published by NGET.
- 2.3 Such novation agreement will, with effect from the Transfer Date, novate to NGESO all rights and obligations of NGET that relate to its role as system operator under the agreements referred to in paragraph [2.4] (including all rights, obligations and liabilities of NGET as system operator that may have accrued in respect of the period prior to the Transfer Date).
- 2.4 Such novation agreement shall be in respect of the following agreements:
- 2.4.1 The Framework Agreement; and 2.4.2 all TO Construction Agreements¹.
- 2.5 NGET shall enter into such novation agreement in (to the extent applicable) its own right, and also (to the extent applicable) on behalf of the Parties that are counterparties to the agreements referred to in paragraph 2.4.
- 2.6 Each Party hereby irrevocably and unconditionally authorises NGET to execute and deliver, on behalf of such Party, a novation agreement as envisaged by this section.
- 2.7 Each Party shall do all such things as NGET or NGESO may reasonably request in relation to the novation of the agreements referred to in paragraph 2.4 from NGET to NGESO.
- 2.8 All rights and obligations novated to NGESO from NGET pursuant to a novation in accordance with this section shall take effect on the Transfer Date without any requirement to follow the admission procedure or the party entry processes set out in Section B of the STC and this paragraph constitutes express provision for the purposes of Section B, paragraph 3.2.1 and applies notwithstanding Section G, paragraph 6.
- 2.9 A novation in accordance with this section shall not affect NGET's continuing status as a Party in its capacity as a Transmission Owner.

3. STC [000]: AMENDMENTS TO EXISTING AGREEMENTS AND DOCUMENTS

- 3.1 Each existing TO Construction Agreement AND each existing Transmission Interface Agreement shall be read and construed, with effect from the Transfer Date, as if the defined terms within it, and the effect of those defined terms², had been amended in accordance with any changes to its corresponding proforma exhibit to the Post STC [000]

¹ Please consider whether there are any additional contracts that should be listed here.

² Consider making this wider than just the definitions – to review once new pro-formas are settled.

STC. Each Party acknowledges and agrees that the provisions of this paragraph shall apply notwithstanding the provisions in the agreements as to variation of those agreements.

- 3.2 Each existing document issued by a Party in accordance with the terms of the Pre STC [000] STC shall be read and construed, with effect from the Transfer Date, as if any references in it to NGET in the context of its the system operator role were references to NGESO.

4. ACCESSION OF NGET AS ONSHORE TRANSMISSION OWNER

- 4.1 The Parties agree that effective on the Transfer Date NGET in its role as an Onshore Transmission Owner shall be deemed to have followed the process set out in Section B to accede to the STC in its role as an Onshore Transmission Owner and followed all due process.
- 4.2 NGET shall take such steps and do all things necessary or appropriate prior to the Transfer Date in order to ensure that it has provided such information as is required to the Panel Secretary and shall sign an Accession Agreement on the Transfer Date.

5. STC [000]: TRANSITION

- 5.1 Each Party shall take such steps and do such things [in relation to the STC and the existing TO Construction Agreements and Transmission Interface Agreements as are within its power and as are necessary or appropriate in order to give full and timely effect to the transfer of the system operator functions from NGET to [NGESO].
- 5.2 Each Party agrees that all things done by NGET prior to the Transfer Date (including but not limited to the making of offers, the provision of reports and statements and the serving of notices) shall be deemed to have been done by [NGESO] and all things received by NGET (including but not limited to applications and notices) shall be deemed to have been received by [NGESO].
- 5.3 NGET shall take such steps and do such things as a necessary or appropriate prior to the Transfer Date in order to ensure that all contracts and documents (including without limitation any Services Capability Specification or Connection Site Specification) required pursuant to the terms of the STC to govern the relationship between NGET and NGESO will be in place and take effect on the Transfer Date or as soon as reasonably practicable thereafter.

SECTION J: INTERPRETATION AND DEFINITIONS

1. INTRODUCTION

- 1.1 This Section J sets out the general rules to be applied in interpreting this Code and any TO Construction Agreement and the defined terms used in this Code (other than those defined elsewhere in this Code).

2. INTERPRETATION AND CONSTRUCTION

- 2.1 In this Code and in each TO Construction Agreement:

2.1.1 the interpretation rules in this paragraph 2; and

2.1.2 the words and expressions defined in paragraph 3,

shall, unless the subject matter or context otherwise requires or is inconsistent therewith, apply.

- 2.2 If in order to comply with any obligation in the Code or any TO Construction Agreement any Party is under a duty to obtain, or in the case of The Company (where appropriate) procure that a User so obtain, the consent or approval (including any statutory licence or permission) ("**the Consent**") of a third party (or the Consent of another Party) such obligation shall be deemed to be subject to the obtaining of such Consent which the Party requiring the Consent shall use its reasonable endeavours to obtain or, in the case of The Company (where appropriate) procure that a User obtain, including (if there are reasonable grounds therefor) pursuing any appeal in order to obtain such Consent.

- 2.3 If such Consent is required from any Party then such Party shall grant such Consent unless it is unable to do so or it would be unlawful for it to do so provided that such grant by such Party may be made subject to such reasonable conditions as such Party shall reasonably determine.

- 2.4 For the avoidance of doubt if the Party who is under a duty to obtain, or in the case of The Company (where appropriate) to procure that a User so obtain, such Consent fails to obtain such Consent having complied with this paragraph 2, the obligation on that Party (in relation to which such Consent is required) shall cease.

- 2.5 Without limitation to paragraphs 2.2, 2.3 or 2.4, each Party shall, to the extent reasonably practicable, comply with any request from a Party for advice or assistance in connection with seeking, obtaining or maintaining Consents.

- 2.6 In this Code and in each TO Construction Agreement:

2.6.1 unless the context otherwise requires, all references to a particular paragraph, Part, Section, Schedule or Annex shall be a reference to that paragraph, Part, Section, Schedule or Annex in or to the Code;

- 2.6.2 a table of contents, headings and introductions are inserted for convenience only and shall be ignored in construing the Code or a TO Construction Agreement as the case may be;
- 2.6.3 references to the word "include" or "including" are to be construed without limitation to the generality of the preceding words;
- 2.6.4 a reference to an Act of Parliament or any part or section or other provision or schedule to an Act of Parliament is a reference to that Act of Parliament and to all orders, regulations, instruments or other subordinate legislation made under or deriving validity from the relevant Act of Parliament;
- 2.6.5 unless the context otherwise requires, any reference to an Act of Parliament, statutory provision, subordinate legislation or code ("**Legislation**") is a reference to such Legislation as amended and in force from time to time and to any Legislation which re-enacts or consolidates (with or without modification) any such Legislation; and
- 2.6.6 references to the masculine shall include the feminine and references in the singular shall include the plural and vice versa and words denoting persons shall include any individual, partnership, firm, company, corporation, joint venture, trust, association, organisation or other entity, in each case whether or not having separate legal personality.

3. DEFINITIONS

The following terms shall have the following meanings:

"Accession Agreement"	an agreement in the form set out in Schedule One whereby a Party Applicant accedes to the Framework Agreement;
"AC Offshore Transmission System"	An Offshore Transmission System which does not comprise a Transmission DC Converter
"Act"	the Electricity Act 1989;
"Active Power"	As defined in the Grid Code
"AF Rules"	Has the meaning given to "allocation framework" in section 13(2) of the Energy Act 2013;
"Affected User"	As defined in the CUSC
"Affiliate"	As defined in the Grid Code
"Agency"	means the Agency for the Cooperation of the Energy Regulators established under 2009/713/EC of the European Parliament and of the Council of the 13 July 2009 establishing an Agency for the

	Cooperation of Energy Regulators as amended from time to time;
“Agreed Transitional Timetable”	as defined in sub-paragraph 10.1.1 of Section I;
“Agreement for Energisation”	A written statement produced by the Transmission Owner confirming that The Company may release an Energisation Notice to a User;
“Agreement for Interim Operational Notification”	A written statement produced by the Transmission Owner confirming that The Company may release an Interim Operational Notification to a User;
“Alternative STC Modification”	an alternative to a STC Modification Proposal proposed in accordance with Section B, sub-paragraph 7.2.2.8;
Alternate Representatives	Persons appointed as such pursuant to Section B, sub-paragraph 6.1A
“Annual Wider Cancellation Charge Statement”	the statement published by The Company each Financial Year in accordance with the User Commitment Methodology;
“Apparatus”	all equipment in which electrical conductors are used, supported or of which they may form a part;
“Applicable STC Objectives”	as defined in Standard Condition B12;
“Approved STC Modifications”	STC Modification Proposals including Urgent STC Modification Proposals or Alternative STC Modifications to the Code approved by the Authority in accordance with Section B;
“Assessment”	the analysis and impact assessment commissioned in accordance with and as defined in Section B, sub-paragraph 7.2.5.2;
“Assessment and Report Phase”	the process for assessing STC Modification Proposals and any Alternative STC Modifications and formulating an STC Modification Report as set out in Section B, sub-paragraph 7.2.5;
“Attributable Works”	those components of the Transmission Construction Works which are required (a) to connect a Power Station which is to be connected at a Connection Site to the nearest suitable MITS Node; or (b) in respect of an Embedded Power Station from the relevant Grid Supply Point to the nearest suitable MITS Node

(and in any case above where the Construction Works include a Transmission substation that once constructed will become the MITS Node, the Attributable Works will include such Transmission substation) and which in relation to a particular User are as specified in the relevant TO Construction Agreement;

“Attributable Works Capital Cost” means the fees, expenses and costs of whatever nature reasonably and properly incurred or due in respect of each component within the Attributable Works;

“Authority” the Gas and Electricity Markets Authority established under section 1 of the Utilities Act 2000;

“Authority Led STC Modification” a proposal to modify the STC which directly arises from a Significant Code Review and where the process of the modification is led by the Authority;

“Authority Led STC Modification Proposal” a proposal for an Authority Led STC modification which has been submitted pursuant to and in accordance with Section B 7.1.10A.1;

“Authority Led STC Modification Report” means, in relation to an Authority Led STC Modification Proposal the report prepared pursuant to and in accordance with Section B 7.1.10A.2;

“Backstop Direction” has the meaning given to it in Section B 7.1.10B;

“Back-Stop Date” the date by which an item of Derogated Plant is to attain its Required Standard, as specified in or pursuant to a Transmission Derogation;

“Back-Up Protection” as defined in the Grid Code;

“Bank Account” a separately designated bank account in the name of The Company at such branch of Barclays Bank PLC, or such branch of any other bank, in the City of London as is notified by The Company to the Transmission Owner, bearing interest from (and including) the date of deposit of principal sums to (but excluding) the date of withdrawal of principal sums from such account, mandated for withdrawal of principal solely by The Company against delivery of a Notice of Drawing for the amount demanded therein and mandated for the transfer of any interest accrued to the Bank Account to such bank account as the Transmission Owner may specify;

“Base Rate”	in respect of any day, the rate per annum which is equal to the base lending rate from time to time of Barclays Bank PLC as at the close of business on the immediately preceding Business Day;
“Bi-annual Estimate”	the estimate of payments required to be provided by The Company to a Transmission Owner in respect of a Construction Project and defined in respect of each Transmission Owner in its TO Construction Agreement with The Company for such Construction Project;
“Black Start”	the process necessary for a recovery from a Total Shutdown or Partial Shutdown;
“BSC”	as defined in Standard Condition C1 of The Company’s Transmission Licence;
“BSC Framework Agreement”	as defined in Standard Condition C1 of The Company’s Transmission Licence;
“Business Day”	any week day other than a Saturday on which banks are open for domestic business in the City of London;
“Business Personnel”	<p>any person who:</p> <ul style="list-style-type: none"> (a) is an officer of the Party; or (b) is an employee of the Party, carrying out any administrative, finance or other corporate services of any kind which, wholly or in part, relate in the case of The Company, to the Main Business and in the case of a Transmission Owner, the Transmission Business; or (c) is engaged by or on behalf of the Party as an agent, sub-contractor or adviser to or otherwise to perform work in relation to services for in the case of The Company the Main Business and in the case of a Transmission Owner, the Transmission Business, <p>and “Business Personnel” shall be construed accordingly;</p>
“Calendar Quarter”	each of the three calendar month periods commencing on, respectively, January 1, April 1, July 1 and September 1 each calendar year;
“Capacity Market Documents”	The Capacity Market Rules, The Electricity Capacity Regulations 2014 and any other Regulations made under

	Chapter 3 of Part 2 of the Energy Act 2014 which are in force from time to time;
“Capacity Market Rules”	The rules made under section 34 of the Energy Act 2013 as modified from time to time in accordance with that section and The Electricity Capacity Regulations 2014;
“CfD Administrative Parties”	The Secretary of State, any CfD Counterparty and any CfD Settlement Services Provider;
“CfD Counterparty”	A person designated as a “CfD counterparty” under section 7(1) of the Energy Act 2013;
“CfD Documents”	The AF Rules, The Contracts for Difference (Allocation) Regulations 2014, The Contracts for Difference (Definition of Eligible Generator) Regulations 2014 and The Contracts for Difference (Electricity Supplier Obligations) Regulations 2014 and any other regulations made under Chapter 2 of Part 2 of the Energy Act 2013 which are in force from time to time;
“CfD Settlement Services Provider”	<p>means any person:</p> <ul style="list-style-type: none"> (i) appointed for the time being and from time to time by a CfD Counterparty; or (ii) who is designated by virtue of Section C1.2.1B of the BSC; <p>in either case to carry out any of the CfD settlement activities (or any successor entity performing CfD settlement activities);</p>
“Change”	any addition, replacement, refurbishment, renovation, modification, alteration, construction or withdrawal (but excluding in respect of any extension of a Transmission System as a result of that Transmission System’s development through OTSDUW Phased Build);
“CM Administrative Parties”	the Secretary of State, the CM Settlement Body, and any CM Settlement Services Provider;
“CM Settlement Body”	the Electricity Settlements Company Ltd or such other person as may from time to time be appointed as Settlement Body under regulation 80 of the Electricity Capacity Regulations 2014;
“CM Settlement Services Provider”	any person with whom the CM Settlement Body has entered into a contract to provide services to it in relation to the performance of its functions under the Capacity Market Documents;

"CMP 192 Transition Process Plan"	means as defined in CUSC Section 10, Paragraph 10.1.7(g);
"Code"	this System Operator – Transmission Owner Code, as required by Standard Condition B12, as amended or modified from time to time and references to the Code include the Code as given contractual force and effect by the Framework Agreement;
"Code Administration Code of Practice"	means the code of practice approved by the Authority and: <ul style="list-style-type: none"> (a) developed and maintained by the code administrators in existence from time to time; (b) amended subject to the Authority's approval from time to time; and (c) re-published from time to time;
"Code Administrator"	means The Company carrying out the role of Code Administrator in accordance with Section B;
"Code Effective Date"	the date of execution of the Framework Agreement;
"Code Procedures"	the procedures forming a part of this Code as more particularly defined in Section A, paragraph 2.3;
"Code Voting Process"	means that process set out in Section B, sub-paragraph 6.7;
"Code Website"	the website for the Code established and maintained by The Company;
"Commissioned"	Plant and Apparatus certified by the Independent Engineer as having been commissioned in accordance with the relevant Commissioning Programme;
"Commissioning Programme"	in relation to a particular Construction Project, as defined in the TO Construction Agreement between The Company and the Transmission Owner to whose Transmission System the Relevant Connection Site is or will be Connected;
"Commissioning Programme Commencement Date"	as defined for a Commissioning Programme in the TO Construction Agreement between The Company and the Transmission Owner to whose Transmission System the Relevant Connection Site is or will be Connected;
"Communications Plant"	electronic communications network infrastructure, including control telephony, used to facilitate real-time communications;
"Competent Authority"	the Secretary of State, the Authority and any local or national agency, authority, department, inspectorate, minister (including

Scottish ministers), ministry, official or public or statutory person (whether autonomous or not) of, or of the government of, the United Kingdom;;

"Completion Date" in relation to a Construction Project, as defined in respect of each Transmission Owner in its TO Construction Agreement with The Company;

"Condition C17 Statement" as defined in Section C, Part Three, paragraph 8.1;

"Confidential Information" means:

(a) in the case of The Company, any information relating to the affairs of a Transmission Owner which is furnished to The Company or its Business Personnel under this Code or any TO Construction Agreement or pursuant to a direction under section 34 of the Act or pursuant to the provisions of the Fuel Security Code; and

(b) in the case of a Transmission Owner, all data and information relating to the affairs of a Party or User supplied to it or its Business under the provisions of this Code or any TO Construction Agreement or pursuant to a direction under section 34 of the Act or pursuant to the provisions of the Fuel Security Code;

"Connect and Manage Arrangements" the arrangements whereby pursuant to Standard Condition C26 and D16 of the transmission licences connection to and/or use of the National Electricity Transmission System is permitted by virtue of a Connect and Manage Derogation on completion of the Enabling Works but prior to completion of the Wider Transmission Reinforcement Works;

"Connect and Manage Derogation" means the temporary derogation from the NETS SQSS available to The Company pursuant to Standard Condition C17 of its Transmission Licence or an Onshore Transmission Owner pursuant to Standard Condition D3 of its Transmission Licence,

"Connect and Manage Derogation Criteria" means

(a) achieve compliance with the "Pre-fault Criteria" set out in Chapter 2 (Generation Connection Criteria Applicable to the Onshore Transmission System) of the NETS SQSS;

(b) achieve compliance with the "Limits to Loss of Power Infeed Risks" set out in Chapter 2 (Generation

Connection Criteria Applicable to the Onshore Transmission System) of the NETS SQSS;

- (c) enable The Company to operate the National Electricity Transmission System in a safe manner;
- (d) resolve any fault level issues associated with the connection and/or use of system by the Connect and Manage Power Station;
- (e) comply with the minimum technical, design and operational criteria and performance requirements under the Grid Code;
- (f) meet other statutory obligations including but not limited to obligations under any Nuclear Site Licence Provisions Agreement; and
- (g) avoid any adverse impact on other Users

“Connect and Manage Derogation Report”

the report required to be prepared by The Company and/or an Onshore Transmission Owner in respect of a Connect and Manage Derogation;

“Connect and Manage Power Station”

As defined in the CUSC

“Connection”

a direct connection to the National Electricity Transmission System by a User (and **"Connected"** shall be construed accordingly);

"Connection Conditions"

that part of the Grid Code which is identified as the Connection Conditions;

"Connection Entry Capacity"

the figure specified as such for a Connection Site and each Generating Unit as set out in the relevant The Company Construction Application;

"Connection Point"

as defined in the Grid Code as at the Code Effective Date;

"Connection Site"

each location at which User Equipment and Transmission Connection Assets required to connect that User to the National Electricity Transmission System are situated (or, in the case of OTSDUW Build, each location that will become such from the OTSUA Transfer Time). If two or more Users own or operate Plant and Apparatus which is connected at any particular location that location shall constitute two (or the appropriate number of) Connection Sites;

"Connection Site Specification"	as defined in Section D, Part One, sub-paragraph 2.6.1;
"Consents"	in relation to a particular Construction Project, as defined in the relevant TO Construction Agreement, and otherwise as defined in this Section J, paragraph 2.2;
"Construction Assumptions Date"	in respect of each Transmission Owner, the date on which such Transmission Owner: <ul style="list-style-type: none"> (a) receives Construction Planning Assumptions from The Company pursuant to Section D, Part Two, paragraph 3.2; or (b) receives notice that The Company does not intend to generate a set of Construction Planning Assumptions under Section D, Part Two, paragraph 3.3, in relation to the Construction Project to which such Construction Planning Assumptions apply;
"Construction Party"	as defined in Section D, Part Two, paragraph 2.2;
"Construction Planning Assumptions"	The background comprising information held by The Company relating to the National Electricity Transmission System, [and User System(s) (as appropriate)], including data submitted pursuant to or included within the Grid Code, CUSC Contracts and any other data held by The Company.
"Construction Project"	as defined in Section D, Part Two, paragraph 2.1;
"Core Industry Document"	as defined in Standard Condition A1;
"Current User"	as defined in sub-paragraph 8.2.1 of Section I;
"Current User Application"	as defined in sub-paragraph 8.2.3 of Section I;
"CUSC"	as defined in Standard Condition C1 of The Company's Transmission Licence;
"CUSC Contract"	as defined in the Grid Code;
"CUSC Framework Agreement"	as defined in Standard Condition C1 of The Company's Transmission Licence;
"CUSC Party"	as defined in Standard Condition A1;

"Customer"	a person to whom electrical power is provided (whether or not they are the provider of such electrical power) other than power to meet Station Demand of that person;
"Data Registration Code"	that part of the Grid Code that is identified as the Data Registration Code;
"Decommissioning Actions"	the procedures, processes and steps required to be taken by Parties as defined in Section B, sub-paragraph 5.1.3;
"Decreasing User"	a User considering a reduction in their TEC to enable the Increasing User to increase their TEC as part of a TEC Trade;
"De-energisation"	the movement of any isolator, breaker or switch or the removal of any fuse whereby no electricity can flow to or from the relevant System through User Equipment;
"Default Interest Rate"	the Base Rate at the due date for payment of an amount under the Code plus two per cent per annum;
"Default Planning Boundary"	the boundary between a Transmission Owner's Transmission System and a User System that is considered as the default by the Transmission Owner for the purpose of planning and developing the National Electricity Transmission System in relation to Construction Projects at a Relevant Connection Site and determined in accordance with Section D, Part One, paragraph 3;
"Derogated Plant "	Plant or Apparatus which is the subject of a Transmission Derogation;
"De-Synchronised Island Procedure"	as defined in the Grid Code as at the Code Effective Date;
"Detailed Design Data"	the data listed in Part 2 of Appendix A of the Planning Code;
"Directive"	includes any present or future directive, requirement, instruction, direction or rule of any Competent Authority, (but only, if not having force in law, if compliance with the Directive is in accordance with the general practice of persons to whom the Directive is addressed) and includes any modification, extension or replacement thereof then in force;
"Disclose"	disclose, reveal, report, publish or transfer by any means and "Disclosure" and "Disclosing" shall be construed accordingly;
"Dispute"	a failure to agree or other dispute between the Parties under or otherwise arising in relation to the subject matter of the Code or

	a TO Construction Agreement including, without limitation, a dispute involving a breach or alleged breach of this Code or a TO Construction Agreement;
"Dispute Notice"	a notice sent to the Authority and each of the other Dispute Parties in order to raise a Dispute under Section H, paragraph 3.2 setting out the details of the Dispute;
"Dispute Parties"	a Party initiating a Dispute and each other Party which is, or is likely to be, materially affected by such Dispute;
"Distribution Code(s)"	the distribution code(s) drawn up pursuant to Distribution Licences as from time to time revised in accordance with such licences;
"Distribution Licence"	a licence issued under section 6(1)(c) of the Act;
"Distribution System"	as defined in the CUSC as at the Code Effective Date;
"E&W NSLPAs"	means (i) the agreement (as from time to time amended) between NGET and [xx] in relation to xx power station and (ii) the agreement (as from time to time amended) between NGET and [] in relation to xx power station and (iii).
"Earthing"	as defined in the Grid Code as at the Code Effective Date;
"Effective Date"	In relation to each TO Construction Agreement, unless otherwise agreed between the relevant Parties, the date of execution of such TO Construction Agreement;
"Electricity Arbitration Association"	the unincorporated members' club of that title formed inter alia to promote the efficient and economic operation of the procedure for the resolution of disputes within the electricity supply industry by means of arbitration or otherwise in accordance with its arbitration rules;
"Electricity Regulation"	means Regulation 2009/714/EC of the European Parliament and of the Council of 13 July 2009 on conditions for access to the network for cross-border exchanges in electricity and repealing Regulation 2003/1228/EC as amended from time to time;
"Embedded Power Station"	a Power Station of an Embedded User;
"Embedded Transmission Bilateral Agreement"	an agreement, between The Company and a holder of a Distribution Licence, which governs the terms by which an Offshore Transmission Owner's Transmission System can connect and remain connected to a Distribution System at an Embedded Transmission Interface Site;

"Embedded Transmission Counterparty"	in the context of an Embedded Transmission Interface Site, the holder of a Distribution Licence with whom The Company has an Embedded Transmission Bilateral Agreement;
"Embedded Transmission Counterparty Equipment"	the Plant and Apparatus owned by an Embedded Transmission Counterparty;
"Embedded Transmission Interface Agreement"	an agreement entered into by a Transmission Owner with an Embedded Transmission Counterparty pursuant to Section C, Part Three, paragraph 3.4;
"Embedded Transmission Interface Asset(s)"	<p>the assets specified as Transmission Interface Assets:</p> <ul style="list-style-type: none"> (a) in the Embedded Transmission Interface Site Specification; and (b) in relation to assets still being constructed, in the relevant TO Construction Agreement;
"Embedded Transmission Interface Site"	each location at which Plant and/or Apparatus forming part of an Offshore Transmission System and Plant and/or Apparatus forming part of a Distribution System required to connect that Offshore Transmission System to the Distribution System (or vice versa) are situated (or, in the case of OTSDUW Build, each location that will become such from the OTSUA Transfer Time);
"Embedded Transmission Interface Site Specification"	as defined in Section D, Part One, sub-paragraph 2.8.1
"Embedded User"	any User whose User Equipment is not Connected;
"Emergency Return to Service Time"	the period of time required for a Transmission Owner to restore the part(s) of a Transmission System affected by an Outage so that such part(s) or any other relevant parts of the Transmission System can again be made available, to the extent identified in the Outage Plan, for the purpose of conveying and affecting the flow of electricity pursuant to Section C, Part Two, sub-paragraph 3.7.7;
"Enabling Works"	those elements of the Transmission Reinforcement Works which in relation to a particular Construction Project are defined as enabling works in the Onshore Transmission Owner's TO Construction Agreement and which have been identified by the Onshore Transmission Owner as those Transmission Reinforcement Works required to meet the Connect and Manage Derogation Criteria and the principles set out in CUSC Section 13;

"Energisation"	the movement of any isolator, breaker or switch or the insertion of any fuse so as to enable Energy to flow from and to the relevant System through Equipment (and "Energised" shall be construed accordingly);
"Energy"	the electrical energy produced, flowing or supplied by an electric circuit during a time interval, being the integral with respect to time of the power, measured in units of watt-hours or standard multiples thereof i.e. 1000 Wh = 1kWh 1000 kWh = 1 MWh 1000MWh = 1 GWh 1000 GWh = 1 TWh
"Engineering Charges"	the charges levied, by each Transmission Owner, in relation to a The Company Construction Application or The Company Request for a Statement of Works;
"EU Code User"	As defined in the Grid Code
"European Commission"	means the institution of that name established under the Treaty on European Union as amended from time to time;
"European Compliance Processes"	As defined in the Grid Code
"European Connection Conditions"	that part of the Grid Code which is identified as the European Connection Conditions;
"EU Generator"	As defined in the Grid Code
"Evaluation Phase"	the phase for evaluation of STC Modification Proposals and any Alternative STC Modifications under Section B, sub-paragraph 7.2.4;
"Event"	an unscheduled or unplanned occurrence on, or relating to, a Transmission System including, without limitation, faults, incidents, breakdowns and adverse weather conditions;
"Exchange Rate Request"	as defined in the CUSC as at the Code Effective Date;
"Exemption"	an exemption granted under section 5 of the Act;

"External Interconnections"	as defined in the Grid Code as at the Code Effective Date;
"Fast Track Criteria"	<p>means that a proposal, if implemented.</p> <p>(a) would meet the Self-Governance Criteria; and</p> <p>(b) is properly a housekeeping modification required as a result of some error or factual change, including but not limited to:</p> <ul style="list-style-type: none"> (i) updating names or addresses listed in the Code; (ii) correcting minor typographical errors; (iii) correcting formatting and consistency errors, such as paragraph numbering; or (iv) updating out of date references to other documents or paragraphs.
"FES Scenarios"	means the forecast future generation (listed in order of likely operation) and Demand backgrounds to be provided by The Company which are to be utilised for the purposes of the development of the Network Options Assessment;
"Financial Year"	the period of 12 months ending on 31 March in each calendar year;
"Flexibility Parameters"	as defined in Section C, Part Two, paragraph 3.7;
"Force Majeure"	<p>in relation to any Party, any event or circumstance which is beyond the reasonable control of such Party and which results in or causes the failure of that Party to perform any of its obligations under the Code including act of God, strike, lockout or other industrial disturbance, act of the public enemy, war declared or undeclared, threat of war, terrorist act, blockade, revolution, riot, insurrection, civil commotion, public demonstration, sabotage, act of vandalism, lightning, fire, storm, flood, earthquake, accumulation of snow or ice, lack of water arising from weather or environmental problems, explosion, fault or failure of Plant and Apparatus (which could not have been prevented by Good Industry Practice), governmental restraint, Act of Parliament, other legislation, bye law and Directive (not being any order, regulation or direction under sections 32, 33, 34 and 35 of the Act) provided that lack of funds or performance or non-performance by an Other Code Party shall not be interpreted as a cause beyond the reasonable control of that Party and provided, for the avoidance of doubt, that weather</p>

	conditions which are reasonably to be expected at the location of the event or circumstance are also excluded as not being beyond the reasonable control of that Party;
"Forecast Offshore Construction Cost"	the forecast total cost of Offshore Construction Works as set out in the relevant Offshore TO Construction Agreement;
"Frequency"	the number of alternating cycle per second (expressed in Hertz) at which a System is running;
"Framework Agreement"	the agreement of that title, in the form approved by the Secretary of State, by which this Code is made contractually binding between the parties to that agreement, as amended from time to time with the approval of the Secretary of State;
"Fuel Security Code"	the Code of that name designated by the Secretary of State, as from time to time modified in accordance with the Transmission Licences ;
"GB Code User"	As defined in the Grid Code
"Generating Unit"	unless otherwise provided in the Grid Code as at the Code Effective Date any Apparatus which produces electricity;
"Generator"	a person who generates electricity under licence or exemption under the Act;
"Go Live Date"	the date which the Secretary of State indicates in a direction shall be the BETTA go-live date;
"Good Industry Practice"	in relation to any undertaking and any circumstances, the exercise of that degree of skill, diligence, prudence and foresight which would reasonably and ordinarily be expected from a skilled and experienced operator engaged in the same type of undertaking under the same or similar circumstances;
"Great Britain" or "GB"	the landmass of England and Wales and Scotland, including internal waters;
"Grid Code"	the code of that name drawn up pursuant to The Company's Transmission Licence, as from time to time modified in accordance with The Company's Transmission Licence;
"Grid Supply Point"	as defined in the CUSC;
Group	means, in respect of each Party Category and subject to Section B, sub-paragraph 6.7.3, each Party that is a member of that Party Category collectively with that Party's Affiliates (if any) who are also members of that Party Category.

"High Voltage" or "HV"	as defined in the Grid Code as at the Code Effective Date;
"HDVC System"	As defined in the Grid Code
"Implementation Date"	the date proposed as the date for the implementation of a STC Modification Proposal or any Alternative STC Modification in accordance with and as defined in Section B, sub-paragraph 7.2.5.8(e);
"Implementation Dispute"	as defined in Section H, paragraph 4.6;
"Increasing User"	a User considering an increase in their TEC as a direct result of a reduction in the Decreasing User's TEC as part of a TEC Trade;
"Independent Engineer"	<p>the engineer specified as such in a TO Construction Agreement. Provided that:</p> <p>(a) where the Parties to the TO Construction Agreement fail to agree on a suitable engineer within 120 days of the date of the TO Construction Agreement; or</p> <p>(b) where any Independent Engineer appointed from time to time shall fail, refuse or cease to act in a capacity set out in the TO Construction Agreement and no substitute engineer of suitable standing and qualification can be agreed by the Parties to the TO Construction Agreement within 30 calendar days;</p> <p>then such engineer as the President of the Institution of Electrical Engineers shall, on the application of either Party, nominate shall be the Independent Engineer.</p>
"Intellectual Property Rights"	patents, trade marks, service marks, rights in designs, trade names, copyrights and topography rights (whether or not any of the same are registered and including applications for registration of any of the same) and rights under licences and consents in relation to any of the same and all rights or forms of protection of a similar nature or having equivalent or similar effect to any of the same which may subsist anywhere in the world;
"Interface Point"	<p>as the context admits or requires either;</p> <p>(a) the electrical point of connection between an Offshore Transmission System and an Onshore Transmission System, or</p>

	(b) the electrical point of connection between an Offshore Transmission System and an Onshore Distribution System;
"Interface Point Capacity"	the maximum amount of Active Power transferable at the Interface Point as declared by an Offshore Transmission Owner, expressed in whole MW;
"Interim Operational Notification"	Certification issued by The Company to the User from time to time to allow the User Equipment to be, or remain, synchronised.
"Interim SYS"	the interim SYS referred to in Standard Condition C11 of The Company's Transmission Licence;
"Interconnector"	as defined in the BSC as at the Code Effective Date;
"Interface Agreement"	an agreement entered into by a Transmission Owner with a User pursuant to Section C, Part Three, paragraph 3.1 or an agreement entered into by a Transmission Owner with another Transmission Owner pursuant to Section C, Part Three, paragraph 3.2;
"Intermittent Power Source"	As defined in the Grid Code
"Interruption"	As defined in the CUSC;
"Interruption Charges"	The charges to be paid by the relevant Transmission Owner to The Company, as determined in accordance with Schedule Ten Part Four;
"Interruption Period"	As defined in the CUSC;
"Investigation Party"	as defined in Section C, Part Three, sub-paragraph 4.2.1;
"Isolation"	as defined in the Grid Code as at the Code Effective Date;
"Joint Investigation"	an investigation conducted jointly by Investigation Parties and, where relevant, other persons into a Significant Incident or Related Significant Incidents or a Possible Relevant Interruption under Section C, Part Three, paragraph 4.2;
"Joint Project Party"	as defined in Section D, Part Two, paragraph 8.1;
"Key Outage Proposal"	the proposal in respect of proposed outages, for a list of MITS circuits as agreed between the licensees, for Year 2 developed, maintained and submitted to The Company by each Transmission Owner in accordance with, and including those matters set out in, Section C, Part Two The agreed list of MITS

circuits shall be reviewed by the licensees as required based on proposed changes to the Transmission System.

“Legally Binding Decisions of the European Commission and/or the Agency”

means any relevant legally binding decision or decisions of the **European Commission** and/or the **Agency**, but a binding decision does not include a decision that is not, or so much of a decision as is not, **Retained EU Law**;

"Legal Requirement"

any Act of Parliament, regulation, licence or Directive;

"Legislation"

as defined in paragraph 2.6.5 of this Section J;

“Letter of Credit”

(a) in respect of Section D, Paragraph 8.4.2 shall mean an irrevocable standby letter of credit in a form reasonably satisfactory to The Company but in any case expressed to be governed by the Uniform Customs and Practice for Documentary Credits 1993 Revision ICC Publication No. 500 or such other form as may be reasonably satisfactory to The Company and allowing for partial drawings and providing for the payment to The Company on demand forthwith on and against The Company’s delivery to the issuer thereof of a Notice of Drawing of the amount demanded therein;

(b) in all other cases shall mean an unconditional irrevocable standby letter of credit in such form as The Company may reasonably approve issued for the account of the Transmission Owner in sterling in favour of The Company, allowing for partial drawings and providing for the payment to The Company forthwith on demand by any United Kingdom clearing bank or any other bank which in each case has a long term debt rating of not less than single “A” by Standard and Poor’s Corporation or by Moody’s Investors Services, or such other bank as The Company may approve and which shall be available for payment at a branch of the issuing bank

"Licence Standards"

the standards and requirements, in respect of each Party, referred to in its Transmission Licence and in accordance with which:

(a) each Transmission Owner is required to plan and develop its Transmission System; and

(b) The Company is required to co-ordinate and direct the flow of electricity onto and over the National Electricity Transmission System,

as varied from time to time in respect of a Transmission Owner by a Transmission Derogation or, in the case of The Company, by any relevant direction issued by the Authority;

"Liquidated Damages" as defined separately between The Company and each Transmission Owner undertaking Works as part of a Construction Project in an applicable TO Construction Agreement;

"Liquidated Damages Liability" means the liquidated damages liability as set out in the relevant TO Construction Agreement;

"Local Joint Restoration Plan" as defined in the Grid Code as at the Code Effective Date;

"Local Safety Instructions" as defined in the Grid Code as at the Code Effective Date;

"Local Switching Procedure" as defined in the Grid Code as at the Code Effective Date;

"Low Voltage" or "LV" as defined in the Grid Code as at the Code Effective Date;

"Main Business" any business of The Company which The Company must carry out under its Transmission Licence;

"Main Plant and Apparatus" As defined in the Grid Code

"Materially Affected Party" means any person or class of persons designated by the Authority as such;

"Material Effect" where used in relation to the identification of a Modification only, shall mean an effect causing:

- (a) The Company or a Transmission Owner to effect any works or to alter the manner of operation of Transmission Plant or Transmission Apparatus at a Connection Site; or
- (b) a User to effect any works or to alter the manner of operation or Plant or Apparatus at the Connection Site or the site of connection,

which, in either case, involves The Company or the relevant Transmission Owner or User in expenditure of more than £10,000;

The phrase "material effect" where otherwise used in the Code shall not be construed as being so limited.

"Medium Voltage" or "MV"	as defined in the Grid Code as at the Code Effective Date;
"MITS"	As defined in the NETS SQSS.
"MITS Connection Works"	As defined in the CUSC
"MITS Node"	means in the context of ascertaining the Attributable Works, a node with (i) more than four Transmission circuits at a Grid Supply Point or (ii) two or more Transmission circuits at a Grid Supply Point;
"Modification"	<p>any:</p> <ul style="list-style-type: none"> (a) actual or proposed replacement, renovation, modification, alteration, or construction by or on behalf of a User or a Transmission Owner to either the User's Plant or Apparatus or the manner of its operation or the Transmission Owner's Transmission Plant or Transmission Apparatus or the manner of its operation which in either case has or may have a Material Effect on a User at a particular Connection Site; (b) Replacement of Assets (irrespective of whether such Replacement of Assets has a Material Effect on a User at a particular Connection Site); or (c) increase in Transmission Entry Capacity, not otherwise associated with the construction or modification of User Equipment, requested by a User under the CUSC; (d) Transmission Construction Works associated with an earlier Request for a Statement of Works; or (e) a material change in the Construction Planning Assumptions concerning the proposed design of an Offshore Transmission System upon which an accepted TO Construction Offer was based; or (f) in the case where a User is undertaking OTSDUW, actual or proposed replacement, renovation, modification, alteration, or construction by or on behalf of a User or a Transmission Owner to either the OTSDUW or the manner of its operation or the Transmission Owner's Transmission Plant or Transmission Apparatus or the manner of its operation which in either case has or may have a material effect on a particular New Transmission Interface Site;

"National Electricity Transmission System"	as defined in Standard Condition A1;
"National Electricity Transmission System Operator Area"	has the meaning set out in Schedule 1 of The Company's Transmission Licence;
"National Electricity Transmission System Performance Report"	as defined in Section C, Part Three, paragraph 8.5;
"National Electricity Transmission System Performance Report Timetable"	as defined in Section C, Part Three, paragraph 8.3;
"NETS SQSS"	The National Electricity Transmission System Security and Quality of Supply Standard issued under Standard Condition C17 of The Company's Transmission Licence (as amended, varied or replaced from time to time)
"Network Operator"	as defined in the Grid Code as at the Code Effective Date;
"Network Options Assessment"	means the process and the report produced by The Company in accordance with Standard Condition C27 of its Transmission Licence (The Network Options Assessment process and reporting requirements);
"New Connection"	a new or proposed Connection for which The Company has received a User Application but in respect of which a New Connection Site has not yet become Connected and Energised (including, for the avoidance of doubt, a new or proposed Connection resulting from OTSDUW Build);
"New Connection Site"	the proposed Connection Site for a New Connection;
"New Construction Planning Assumptions"	as defined in sub-paragraph 9.2.1 of Section I;
"New Embedded Transmission Interface Site"	a new or proposed Embedded Transmission Interface Site but in respect of which such New Transmission Interface Site has not yet become Energised;
"New Transitional Application"	as defined in sub-paragraph 9.1.3 of Section I;

“New Transmission Interface Site”	a new or proposed Transmission Interface Site but in respect of which such New Transmission Interface Site has not yet become Energised;
“NGESO”	The National Grid Electricity System Operator, referred to as The Company. This definition is retained for reference in the transitional arrangements as set out in section I and certain schedules and agreements.
"The Company"	National Grid Electricity System Operator Limited (No. 11014226) whose registered office is 1-3 Strand, London WC2N 5EH as the holder of the transmission licence granted, or treated as granted, pursuant to Section 6(1)(b) of the Act and in which section C of the standard transmission licence conditions applies.;
“The Company Application Date”	in respect of each Transmission Owner, the date on which such Transmission Owner receives an effective The Company Construction Application or The Company Request for a Statement of Works in relation to a Construction Project;
“The Company Charges”	Charges comprising Interruption Payments, Offshore Construction Securities and Offshore Compensation Payments
"The Company Connection Application"	an application made by The Company to a Transmission Owner pursuant to Section D, Part Two, paragraph 2.2 in relation to the construction of a New Connection Site and containing the information set out in Schedule Five;
"The Company Construction Application"	as defined in Section D, Part Two, sub-paragraph 2.1.2;
"The Company Credit Rating"	<p>any one of the following:-</p> <p>(a) a credit rating for long term debt of A- and A3 respectively as set by Standard and Poor’s or Moody’s respectively;</p> <p>(b) an indicative long term private credit rating of A- and A3 respectively as set by Standard and Poor’s or Moody’s as the basis of issuing senior unsecured debt;</p> <p>(c) a short term rating by Standard and Poor’s or Moody’s which correlates to a long term rating of A- and A3 respectively; or</p> <p>(d) where the Offshore Transmission Owner’s licence issued under the Electricity Act 1989 requires that User to maintain a credit rating, the credit rating defined in that User’s Licence;</p>

"The Company Investment Plan"	as defined in Section D, Part One, sub-paragraph 2.1.4;
"The Company Modification Application"	an application made by The Company to a Transmission Owner pursuant to Section D, Part Two, paragraph 2.2 in relation to the construction of a Modification and containing the information set out in Schedule Six;
"The Company Request for a Statement of Works"	an application made by The Company to a Transmission Owner pursuant to Section D, Part Four, paragraph 1.1 in relation the assessment of the impact on the National Electricity Transmission System of a Power Station connecting to a Distribution System and containing the information set out in Schedule 13;
The Company TEC Exchange Rate Application	an application made by The Company to a Transmission Owner pursuant to Section D, Part Three, paragraph 1.1 in relation to the calculation of a TO TEC Exchange Rate and containing the information set out in Schedule 11;
"NGET"	National Grid Electricity Transmission plc (No 2366977) whose registered office is at 1-3 Strand, London WC2N 5EH;
"Non-Embedded Customer"	as defined in the CUSC as at the Code Effective Date;
"Non-Performing Party"	A Party that is unable to carry out any of its obligations under the Code in accordance with Section G, paragraph 8.1;
"Normal Capability Limits"	as defined in Section C, Part One, sub-paragraph 3.1.1;

“Normal Operating Range”	<p>Subject as provided below, the voltage on the 400kV part of the Onshore Transmission System at each Interface Point with an Offshore Transmission System will normally remain within $\pm 5\%$ of the nominal value unless abnormal conditions prevail. The minimum voltage is -10% and the maximum voltage is $+10\%$ unless abnormal conditions prevail, but voltages between $+5\%$ and $+10\%$ will not last longer than 15 minutes unless abnormal conditions prevail. Voltages on the 275kV and 132kV parts of the Onshore Transmission System at each Interface Point with an Offshore Transmission System will normally remain within the limits $\pm 10\%$ of the nominal value unless abnormal conditions prevail. At nominal System voltages below 132kV the voltage of the Onshore Transmission System at each Interface Point with an Offshore Transmission System will normally remain within the limits $\pm 6\%$ of the nominal value unless abnormal conditions prevail. Under fault conditions, voltage may collapse transiently to zero at the point of fault until the fault is cleared.</p> <p>The Company and an Offshore Transmission Owner may agree greater or lesser variations in voltage to those set out above in relation to a particular Interface Point, and insofar as a greater or lesser variation is agreed, the relevant figure set out above shall, in relation to that Offshore Transmission System at the particular Interface Point, be replaced by the figure agreed;</p>
“Notice of Drawing”	a notice of drawing signed by or on behalf of The Company;
“Nuclear Site Licence Provisions Agreement”	As defined in the CUSC
“ODIS Programme”	as defined in Section D, Part One, sub-paragraph 5.1.2;
“Offshore”	means wholly or partly in Offshore Waters and when used in conjunction with another term and not defined means that the associated term is to be read accordingly;
“Offshore Compensation Payments”	as defined in Section E, sub-paragraph 3.1.3;
“Offshore Construction Completed Date”	the date on which an Offshore Transmission System is deemed to be commissioned in accordance with a TO Construction Agreement;
“Offshore Construction Secured Amount”	<p>an amount equivalent to the sum of:</p> <p>(a) 20% of the Forecast Offshore Construction Cost; and</p> <p>(b) the Liquidated Damages Liability;</p>
“Offshore Construction Securities”	as defined in Section E, sub-paragraph 3.1.2;

"Offshore Construction Works"	Transmission Construction Works undertaken by an Offshore Transmission Owner;
"Offshore Tender Regulations"	those regulations made by the Authority in accordance with section 6C of the Act to facilitate the determination on a competitive basis of the person to whom an offshore transmission licence is to be granted
"Offshore TO Construction Agreement"	as defined in Schedule Nine, Part C;
"Offshore Transmission Owner"	either, <ul style="list-style-type: none"> (a) such person in relation to whose Transmission Licence the Standard Conditions in Section E (offshore transmission owner standard conditions) have been given effect; or, (b) A Party who has acceded to this Code prior to the grant of a Transmission Licence referred to in (a) above as a requirement of the Offshore Tender Regulations
"Offshore Transmission System"	As defined in the Grid Code
"Offshore Transmission System Development User Works" or "OTSDUW"	as appropriate, either: <ul style="list-style-type: none"> (a) in relation to a particular Construction Project, the design, planning or consenting of assets (that are to form a Transmission System) which design, planning and consenting is to be undertaken by a User preparatory to OFTO Build as identified in Part 2 of Appendix I to the relevant TO Construction Agreement; or (b) OTSDUW Build;
"Offshore Transmission System User Assets" or "OTSUA"	the Plant and Apparatus (offshore and onshore) resulting from OTSDUW Build;
"Offshore Waters"	has the meaning given to "offshore waters" in Section 90(9) of the Energy Act 2004;
"OFTO Build"	where the installation and commissioning of Plant and Apparatus (offshore and onshore) that will constitute a Transmission System is undertaken by an Offshore Transmission Owner but a User has undertaken the design, planning and consenting for the same as OTSDUW;
"One Off Works"	the works described as such in a TO Construction Agreement;

“Onshore”	means within Great Britain (and when used in conjunction with another term and not defined means that the associated term is to be read accordingly);
“Onshore TO Construction Agreement”	as defined in Schedule Eight, sub-paragraph 1.1.3;
“Onshore Transmission Owner”	NGET, SHET or SPT or such other person in relation to whose Transmission Licence the Standard Conditions in Section D (transmission owner standard conditions) have been given effect;
“Onshore Transmission System”	As defined in the Grid Code
"Operating Code"	that part of the Grid Code which is identified as the Operating Code;
"Operational"	in relation to Works undertaken by a Transmission Owner as part of a Construction Project, means that such Works have been completed and, in the case of Works at a Connection Site, Commissioned so that, subject to any Works being undertaken by The Company or a Transmission Owner, the User can use the National Electricity Transmission System and any User Equipment the subject of the Construction Project to undertake those acts and things capable of being undertaken pursuant to the CUSC;
"Operational Capability Limits"	as defined in Section C, Part One, paragraph 4.3;
"Operational Effect"	an effect which causes the National Electricity Transmission System to operate (or be at a materially increased risk of operating) differently to the way in which it would or may have normally operated in the absence of such effect;
"Other Code"	as the context admits or requires, any of the CUSC, CUSC Framework Agreement, Grid Code, BSC, BSC Framework Agreement and any agreement entered into pursuant to any of these;
"Other Code Party"	other than The Company, a party (including its officers, employees or agents) to or under any Other Code;
“OTSDUW Build”	the design, planning and consenting, installation and commissioning by (or on behalf of) a User of Plant and Apparatus (offshore and onshore) that will constitute a

	Transmission System on its transfer to an Offshore Transmission Owner;
“OTSDUW Build Application”	an The Company Construction Application in relation to a New Connection where OTSDUW Build applies;
“OTSDUW Completion Report”	in relation to OTSDUW Build, a report to The Company in respect of the OTSUA in the same form and containing the same information as a Completion Report (as defined in a TO Construction Agreement) (and it is acknowledged that, in the case of OTSDUW Phased Build, there will be a separate Completion Report for each phase);
“OTSDUW Data”	information related to OTSUA or OTSDUW;
“OTSDUW Phased Build”	OTSDUW Build that is to be undertaken in phases (as identified in the OTSDUW Build Application), with separate OTSUA Transfer Times for separate elements of the Plant and Apparatus that will eventually constitute a single Transmission System;
“OTSUA Transfer Time”	in respect of any Offshore Transmission System User Assets, the time and date at which that such Offshore Transmission System User Assets are transferred to an Offshore Transmission Owner (and it is acknowledged that, in the case of OTSDUW Phased Build, there will be a separate OTSUA Transfer Time for each phase);
"Outage"	a planned temporary reduction in the extent to which Transmission Services are provided by a Transmission Owner pursuant to Section C, Part One, paragraph 2.1;
"Outage Change"	has the meaning given in the Transmission Licence;
"Outage Implementation Process"	as defined in Section C, Part Two, paragraph 6.1;
"Outage Plan"	the plan for the placement of Outages for each Financial Year developed and maintained by The Company in accordance with Section C, Part Two;
"Panel Chairperson"	the person appointed in accordance with and as defined in Section B, sub-paragraph 6.1.4;
“Panel Secretary”	the secretary appointed from time to time in accordance with Section B, sub-paragraph 6.1.3;
"Part"	a part of this Code as referred to herein;

"Partial Shutdown"	the same as a Total Shutdown except that all generation has ceased in a separate part of the Total System and there is no electricity supply from External Interconnections or other parts of the Total System to that part of the Total System and, therefore that part of the Total System is shutdown, with the result that it is not possible for that part of the Total System to begin to function again without The Company's directions relating to Black Start;
"Party"	as defined in Section B, paragraph 2.1;
"Party Applicant"	a Transmission Licensee or person obliged by the Offshore Tender Regulations wishing to enter into the Framework Agreement;
"Party Category"	means, as the context requires, one of the following categories: (a) The Company (b) NGET; (c) SHET; (d) SPT; and (e) the Offshore Transmission Owner Parties collectively.;
"Party Details"	the details required from a Party and Party Applicant under Section B, sub-paragraph 3.1.2 and paragraph 4.1 as applicable;
"Party Entry Processes"	the procedures, processes and steps required to be taken by a Party on entry to the Code as defined in Section B, sub-paragraph 3.2.3;
"Party Liable"	as defined in Section G, paragraph 4.2;
"Party Representatives"	the representatives of the Parties as defined in Section B, sub-paragraph 6.1.2;
"Paying Party"	as defined in Section E, paragraph 3.1;
"Permitted Activities"	activities carried on by: (a) The Company, for the purposes of its Main Business; and (b) a Transmission Owner, for the purpose of its Transmission Business;
"Performance Bond"	an on first demand without proof or conditions irrevocable performance bond or performance guarantee executed as a deed in a form reasonably satisfactory to The Company but in any case allowing for partial drawings and providing for the payment to The Company on demand forthwith on and against

	The Company delivery to the issuer thereof of a Notice of Drawing of the amount demanded therein;
"Planned Works"	as defined in Section D, Part One, sub-paragraph 2.1.2.3;
"Planning Assumptions"	in respect of each Transmission Owner: <ul style="list-style-type: none"> (a) The Company's forecasts of power flows onto and off the Transmission Owner's Transmission System under conditions which The Company reasonably foresees will arise in the course of a Financial Year; or (b) information which The Company reasonably considers is necessary to allow the Transmission Owner to forecast power flows on to and off a Transmission Owner's Transmission System under conditions which The Company reasonably foresees will arise in the course of a Financial Year of operation, developed, in each case, in accordance with Schedule Three;
"Planning Code"	that part of the Grid Code which is identified as the Planning Code;
"Plant"	fixed and moveable items used in the generation and/or supply and/or transmission of electricity other than Apparatus;
"Possible Relevant Interruption"	means an interruption which requires investigation to ascertain whether or not it is a Relevant Interruption;
"Power Factor"	As defined in the Grid Code;
"Power Station"	as defined in the CUSC as at the Code Effective Date;
"Proceedings"	as defined in Section G, paragraph 17.1;
"Progress Report"	the progress report prepared and submitted by the STC Modification Panel in accordance with Section B, sub-paragraph 7.2.8.1;
"Proposed STC Modification Report"	the proposed form of the STC Modification Report developed in accordance with and as defined in Section B, sub-paragraph 7.2.5.8;
"Proposer"	a Party or other person making a proposal for an amendment to the Code as defined in Section B, paragraph 7.2.2.1;

"Protection"	as defined in the Grid Code as at the Code Effective Date;
"Purchase Contracts"	As defined in the Grid Code
"Qualified Bank"	a City of London branch of a bank, its successors and assigns, which has throughout the validity period of the Performance Bond or Letter of Credit it issues in favour of The Company, a rating of at least A- in Standard and Poor's long term debt rating or A3 in Moody's long term debt rating provided that such bank is not during such validity period put on any credit watch or any similar credit surveillance which gives The Company reasonable cause to doubt that such bank may not be able to maintain the aforesaid rating throughout the validity period and no other event has occurred which gives The Company reasonable cause to have such doubt;
"Qualified Company"	<p>a company which is a public company or a private company within the meaning of section 1(3) of the Companies Act 1985 and which is either :</p> <p><u>(a)</u> a shareholder of the User or any holding company of such shareholder or</p> <p>(b) any subsidiary of any such holding company, but only where the subsidiary</p> <p style="padding-left: 40px;">(i) demonstrates to The Company's satisfaction that it has power under its constitution to give a Performance Bond other than in respect of its subsidiary;</p> <p style="padding-left: 40px;">(ii) provides an extract of the minutes of a meeting of its directors recording that the directors have duly concluded that the giving of the Performance Bond is likely to promote the success of that subsidiary for the benefit of its members;</p> <p style="padding-left: 40px;">(iii) provides certified copies of the authorisation by every holding company of the subsidiary up to and including the holding company of the User, of the giving of the Performance Bond,</p> <p>(the expressions "holding company" and "subsidiary" having the respective meanings assigned thereto by section 736, Companies Act 1985 as supplemented by section 144(3), Companies Act 1989) and which has throughout the validity period of the Performance Bond it gives in favour of The Company, a rating of at least A- in Standard and Poor's long term debt rating or A3 in Moody's long term debt rating or such</p>

lesser rating which The Company may in its absolute discretion allow by prior written notice given pursuant to a resolution of its board of directors for such period and on such terms as such resolution may specify provided that such company is not during such validity period put on any credit watch or any similar credit surveillance procedure which gives The Company reasonable cause to doubt that such company may not be able to maintain the aforesaid rating throughout the validity period of the Performance Bond and no other event has occurred which gives The Company reasonable cause to have such doubt;

"Quorum"	the quorum required for a STC Modification Panel Meeting as defined in Section B, sub-paragraph 6.4.5;
"Reactive Power"	As defined in the Grid Code;
"Reasonable Charges"	reasonable cost reflective charges comparable to charges for similar services obtainable in the open market;
"Receiving Party"	as defined in Section E, paragraph 3.1;
"Reference Notice"	a notice sent to the Authority or the Electricity Arbitration Association (as appropriate) and copied to each other Dispute Party in relation to a Dispute under Section H, paragraphs 4.1 or 5.1 setting out details of the Dispute;
"Regulations"	the Electricity Safety, Quality and Continuity Regulations 2002;
"Related Significant Incidents"	a series of Significant Incidents in which one or more Significant Incidents cause or exacerbate one or more other Significant Incidents;
"Related Undertaking"	as defined in Standard Condition A1;
"Relevant Connection Site"	in respect of each Construction Project, Exchange Rate Request or Request for a Statement of Works: (a) the Connection Site or New Connection Site which is the subject of the relevant User Application; or (b) in the case of a User Application made to The Company by an Embedded User, the connection site of such Embedded User;
"Relevant Instrument"	any or, as the context may require, a particular one of the following: (a) the Act and all subordinate legislation made under the Act; (b) the Data Protection Act 1998 and all subordinate legislation made under it;

(c) any Transmission Licence and any determination or notice made or issues by the Authority pursuant to the terms thereof,

and whether under any of the foregoing or otherwise, all authorisations, approvals, licences, exemptions, filings, registrations, notarisations, consents, guidelines and other matters which are required or which a Party acting in accordance with Good Industry Practice would obtain or comply with for the purposes of the Code, of or from any Competent Authority;

"Relevant Parties"	the Parties to a Code Procedure or proposed new Code Procedure;
"Relevant Party Category"	means, as the context requires, a Party Category containing at least one Relevant Party;
"Relevant Interruption"	as defined in the CUSC;
"Replacement of Assets"	any replacement of Transmission Connection Assets by The Company or a Transmission Owner which is the subject of, or otherwise requires, notice to be given by The Company to a User under and pursuant to the CUSC;
"Request for a Statement of Works"	an application made by a User to The Company under and pursuant to the CUSC in order that the impact on the National Electricity Transmission System of a Power Station connecting to that User's Distribution System may be assessed;
"Required Standard"	in relation an item of Derogated Plant, the respective standard required of that item (which shall not exceed that required by the Grid Code or the Licence Standard(s) as specified in or pursuant to a Transmission Derogation);
"Retained EU Law"	has the same meaning as that given by section 6 of the European Union (Withdrawal) Act 2018 (as amended by the European Union (Withdrawal Agreement) Act 2020)
"Safety Co-ordinators"	As defined in the Grid Code as at the Code Effective Date;
"Safety Rules"	the rules of a Transmission Owner or a User that seek to ensure that persons working on Plant and/or Apparatus to which the rules apply are safeguarded from hazards arising from the System;
"Schedule"	a schedule to and forming a part of this Code as referred to herein;

"Scottish NSLPAs"	the agreement (as from time to time amended) between SPT and British Energy Generation (UK) Limited in relation to (i) Hunterston power station and Torness power station and (ii) the agreement (as from time to time amended) between SPT and British Nuclear Fuels plc in relation to Chapelcross power station.
"SCR Guidance"	means a document of that title created and maintained by the Authority to provide guidance to interested parties on the conduct of an SCR by the Authority;
"Section"	a section of and forming a part of this Code as referred to herein;
"Secured Event"	as defined in respect of the National Electricity Transmission System and each of the Parties' Transmission Systems in the Licence Standards;
"Self-Governance Criteria"	<p>means that a proposal, if implemented:</p> <p>(a) is unlikely to have a material effect on:</p> <ul style="list-style-type: none"> (i) existing or future electricity consumers; and (ii) completion in the generation, distribution or supply of electricity or any commercial activities connected with the generation, distribution or supply of electricity; and (iii) the operation of the national electricity transmission system; and (iv) matters relating to sustainable development, safety or supply, or the management of market or network emergencies; and (v) the Code's governance procedures or modification procedures; and <p>(b) is unlikely to discriminate between different classes of Parties.</p>
"Self-Governance Statement"	means the statement prepared and sent by the Panel Secretary pursuant to Section B paragraph 7.2.6B;
"Services Capability Specification"	the specification of Transmission Owner Services provided and maintained in accordance with Section C, Part One, paragraph 3.1;
"Services Reduction"	as defined in Section C, Part One, sub-paragraph 4.1.2;
"Services Reduction Risk"	as defined in Section C, Part One, sub-paragraph 4.5.2;

"Services Restoration Proposal"	as defined in Section C, Part One, sub-paragraph 4.6.4;
"Seven Year Statement"	the annual statement prepared by The Company in accordance with Section D, Part One, paragraph 4 and Standard Condition C11 of its Transmission Licence;
"Seven Year Statement Works"	the works set out for a Transmission Owner in the Seven Year Statement and in a TO Construction Agreement which in such Transmission Owner's reasonable opinion are required to be completed before the Completion Date to ensure that the National Electricity Transmission System complies with the requirements of Standard Condition C17 of The Company's Transmission Licence prior to a Construction Project being made Operational;
SHET	means Scottish Hyrdo Electric Transmission plc (No SC213461) whose register office is at Inveralmond House, 200 Dunkeld Road, Perth, PH1 3AQ;
"Significant Code Review"	<p>means a review of one or more matters which the Authority considers is likely to:</p> <p>(a) relate to the Code (either on its own or in conjunction with other industry codes); and</p> <p>(b) be of particular significance in relation to its principal objective and/or general duties (under section 3A of the Act), statutory functions and/or relevant obligations arising under Retained EU Law , and</p> <p>concerning which the Authority has issued a notice to a Party or the Parties (among others, as appropriate) stating:</p> <p>(i) that the review will constitute a significant code review;</p> <p>(ii) the start date of the significant code review; and</p> <p>(iii) the matters that will fall within the scope of the review;</p>
"Significant Code Review Phase"	has the meaning set out in Section B, paragraph 7.1.7 (b);
"Significant Incident"	an Event which any Party determines, pursuant to Section C, Part Three, paragraph 4.1.3, has had or may have a significant effect on the National Electricity Transmission System including,

without limitation, an Event(s) having an Operational Effect which results in, or may result in:

- (a) operation of Plant and/or Apparatus either manually or automatically;
- (b) voltage on any part of the National Electricity Transmission System moving outside statutory limits;
- (c) frequency of any part of the National Electricity Transmission System falling outside statutory limits; or
- (d) instability of any part of the National Electricity Transmission System.

"Site Responsibility Schedule"

as defined in the Grid Code as at the Code Effective Date;

"Special Condition"

a special condition of a Transmission Licence;

"SPT"

means SP Transmission plc (No SC189126) whose registered office is at Ochil House, 10 Technology Avenue, Hamilton Int'L Technology Park, Blantyre, Scotland, G72 0HT;

"Standard Condition"

a standard condition of Transmission Licences;

"Standard Planning Data"

the data listed in Part 1 of Appendix A of the Planning Code;

"Standard STC Modification Proposal"

means an STC Modification Proposal which does not fall within a Significant Code Review, satisfy the Self Governance Criteria or the Fast Track Criteria which shall be dealt with in accordance with Section B paragraphs 7.1.4 to 7.1.6 and 7.2.1 to 7.2.6.

"Station Demand"

as defined in the CUSC as at Code Effective Date;

"Statement of Works Assumptions Date"

in respect of each Transmission Owner, the date on which such Transmission Owner:

- (a) receives Statement of Works Planning Assumptions from The Company pursuant to Section D, Part Four, paragraph 2.2; or
- (b) receives notice that The Company does not intend to generate a set of Statement of Works Planning Assumptions under Section D, Part Four, paragraph 2.3,

	in relation to the Statement of Works Project to which such Statement of Works Planning Assumptions apply;
"Statement of Works Party"	as defined in Section D, Part Four, paragraph 1.1;
"STC Modification Fast Track Report"	has the meaning set out in STCP 24-3 paragraph 2.1;
"STC Modification Self-Governance Report"	has the meaning set out in Section B, sub-paragraph 7.2.6B.5;
"STC Modification Panel Meeting"	a meeting of the STC Modification Panel as defined in Section B, sub-paragraph 6.1.2;
"STC Modification Panel Self-Governance Vote"	means the vote of the STC Modification Panel undertaken pursuant to Section B paragraph 7.2.6B.10;
"STC Modification Procedures"	the procedures to be followed in respect of amendments to the Code as set out in Section B, paragraph 7;
"STC Modification Proposal"	a proposed amendment to this Code as defined at Section B, sub-paragraph 7.2.2.3;
"STC Modification Register"	the register established and maintained by the Panel Secretary in accordance with Section B, sub-paragraph 7.2.7.1;
"STC Modification Report"	the report in respect of a STC Modification Proposal or any Alternative STC Modification as defined in Section B, sub-paragraph 7.2.5.11;
"System"	as defined in the CUSC as at the Code Effective Date;
"System Construction"	Transmission Reinforcement Works or any other Works required to be undertaken by a Transmission Owner in order to facilitate the use or change in the use of the National Electricity Transmission System by a User;
"System Construction Application"	an application made by The Company to a Transmission Owner pursuant to Section D, Part Two, paragraph 2.2 in relation to System Construction and containing the information set out in Schedule Seven;
"TEC Exchange Assumption Date"	in respect of each Transmission Owner, the date on which such Transmission Owner:

	(a) receives TEC Exchange Planning Assumptions from The Company pursuant to Section D, Part Three, paragraph 2.2; or
	(b) receives notice that The Company does not intend to generate a set of Construction Planning Assumptions under Section D, Part Two, paragraph 2.3,
	in relation to The Company TEC Exchange Rate Application to which such TEC Exchange Planning Assumption apply;
"TEC Exchange Party"	as defined in Section D, Part Three, paragraph 1.1;
"TEC Exchange Planning Assumption"	as defined in Section D, Part Three, paragraph 2.1;
"TEC Trade"	as defined in the CUSC as of the Code Effective Date;
"Tests"	tests involving simulating conditions or the controlled application of irregular, unusual or extreme conditions on a Transmission System or any part of a Transmission System or any other tests of a minor nature but which do not include commissioning or re-commissioning tests (and "Testing" shall be construed accordingly);
"Third Party Works"	the works specified as such in a TO Construction Agreement;
"TO Charges"	charges comprising the TO General System Charges and TO Site-Specific Charges;
"TO Commissioning Programme"	the sequence of operations/tests necessary to connect User Works and Transmission Connection Asset Works to the National Electricity Transmission System for the purpose of making the User Works available for operation to be determined, in respect of a Transmission Owner, pursuant to the relevant TO Construction Agreement between such Transmission Owner and The Company;
"TO Construction Agreement"	an Onshore TO Construction Agreement or an Offshore TO Construction Agreement;
"TO Construction Offer"	an offer made by a Transmission Owner to The Company pursuant to Section D, Part Two, paragraph 4 and containing those matters set out in Schedule Eight;
"TO Construction Programme"	as agreed between The Company and a Transmission Owner in relation to a Construction Project, or part of a Construction Project, and set out in the relevant TO Construction Agreement;

"TO Final Sums"	<p>the amount payable by The Company on termination of a TO Construction Agreement being the aggregate from time to time and for the time being of:</p> <p>(a) all Engineering Charges arisen prior to the date of termination as well as any associated financing costs (e.g. Interest During Construction);</p> <p>(b) Any other fees, expenses and costs (excluding costs on account of interest charges incurred by the Transmission Owner) of whatever nature reasonably and properly incurred or due by the Transmission Owner in respect of any part of the Transmission Construction Works;</p>
"TO General System Charges"	as defined in Section E, sub-paragraph 2.1.1;
"TO Site Specific Charges"	as defined in Section E, sub-paragraph 2.1.2;
"TO Statement of Works Notice"	as defined in Section D, Part Four, paragraph 3.1;
"TO TEC Exchange Rate"	the Transmission Entry Capacity available to a specific User as a direct result of a specific reduction in the Transmission Entry Capacity available to another User as calculated by a Transmission Owner and provided to The Company in accordance with Schedule 12;
"Total System"	the National Electricity Transmission System and all User Systems in the National Electricity Transmission System Operator Area;
"Total Shutdown"	as defined in the Grid Code as at the Code Effective Date;
"Transition Period"	as defined in Standard Condition A1;
"Transitional Connection Site"	as defined in sub-paragraph 9.1.3.1 of Section I;
"Transitional Connection Site Specification"	as defined in sub-paragraph 8.1.1 of Section I;
"Transitional Construction Planning Assumptions"	as defined in sub-paragraph 8.3.1 of Section I;
"Transitional Implementation Dispute"	as defined in paragraph 13.5 of Section I;

"Transitional Investment Plans"	as defined in sub-paragraph 7.1.1 of Section I;
"Transitional The Company Investment Plan"	as defined in sub-paragraph 7.2.1 of Section I;
"Transitional Outage Plan"	as defined in sub-paragraph 5.1.1 of Section I;
"Transitional Outage Proposal"	as defined in sub-paragraph 5.2.1 of Section I;
"Transitional Planning Assumptions"	as defined in sub-paragraph 7.3.1 of Section I;
"Transitional Services Capability Specification"	as defined in paragraph 4.1 of Section I;
"Transmission"	when used in conjunction with another term relating to equipment, whether defined or not, that the associated term is to be read as being part of or directly associated with the National Electricity Transmission System and not of or with a User System;
"Transmission Business"	as defined in Standard Condition A1;
"Transmission Connection Asset(s)"	the assets specified as Transmission Connection Assets: (a) in the Connection Site Specification; and (b) in relation to assets still being constructed, in the relevant TO Construction Agreement;
"Transmission Connection Asset Works"	the works specified as such in a TO Construction Agreement (but excluding any works carried out by a User on behalf of the relevant Transmission Owner);
"Transmission Construction Works"	as defined in Schedule Eight, sub-paragraph 1.1.3;
"Transmission DC Converter"	As defined in the Grid Code
"Transmission Derogation"	means (a) a direction issued by the Authority relieving a Transmission Owner from the obligation under its Transmission Licence to comply with standards or requirements in accordance with which it is otherwise required to plan and develop its Transmission System (including any conditions which apply in respect of such derogation) and/or (b) a Connect and Manage

	Derogation as the Context requires (and "Derogated" shall be construed accordingly);
"Transmission Entry Capacity"	the figure specified as such for a Connection Site in a The Company Construction Application or The Company TEC Exchange Application;
"Transmission Information"	information related to the planning, development, operation or configuration of any part of a Transmission System or of the National Electricity Transmission System, but not including User Data;
"Transmission Interface Agreement"	as defined in Schedule Fifteen;
"Transmission Interface Asset(s)"	the assets specified as Transmission Interface Assets: <ul style="list-style-type: none"> (a) in the Interface Site Specification; and (b) in relation to assets still being constructed, in the relevant TO Construction Agreement;
"Transmission Interface Site"	each location at which Plant and/or Apparatus forming part of an Offshore Transmission System and Plant and/or Apparatus forming part of an Onshore Transmission System required to connect that Offshore Transmission System to the Onshore Transmission System (or vice versa) are situated (or, in the case of OTSDUW Build, each location that will become such from the OTSUA Transfer Time)
"Transmission Interface Site Party"	as defined in Section C, Part Three, sub-paragraph 3.2
"Transmission Interface Site Specification"	as defined in Section D, Part One, sub-paragraph 2.7.1
"Transmission Investment Plan"	the plan developed by each Transmission Owner in relation to the development and maintenance each Financial Year of its Transmission System pursuant to Section D, Part One, sub-paragraph 2.1.1 and containing those matters set out in sub-paragraph 2.1.2;
"Transmission Licence"	a transmission licence granted or treated as granted under section 6(1)(b) of the Act;
"Transmission Licence Conditions"	the conditions contained in and amended from time to time in accordance with a Transmission Licence;

"Transmission Licensee"	the holder for the time being of a Transmission Licence;
"Transmission Owner"	an Onshore Transmission Owner or an Offshore Transmission Owner
"Transmission Owner"	An Onshore Transmission Owner or an Offshore Transmission Owner which could include a Type 1 Transmission Owner or Type 2 Transmission Owner.
"Transmission Owner Site"	a site owned (or occupied pursuant to a lease, licence or other agreement) by a Transmission Owner in which there is a Connection. For the avoidance of doubt, a site owned by a User but occupied by a Transmission Owner is a Transmission Owner Site;
"Transmission Reinforcement Works"	in relation to a particular Construction Project, as defined in respect of each relevant Transmission Owner in its TO Construction Agreement (but excluding any works carried out by a User on behalf of the relevant Transmission Owner);
"Transmission Services"	as defined in Section C, Part One, paragraph 2;
"Transmission System"	in respect of each Party, has the meaning given to the term "licensee's transmission system" in Standard Condition A1;
"Type 1 Transmission Owner"	A Transmission Owner who owns a Transmission System and that Transmission System was first connected to the System before 27 April 2019 and the purchase contracts for its Plant and Apparatus forming that Transmission System had been concluded before 17th May 2018
"Type 2 Transmission Owner"	A Transmission Owner who owns a Transmission System and that Transmission System was first connected to the System on or after 27 April 2019 and the purchase contracts forming the major part of its Plant and Apparatus forming that Transmission System had been concluded on or after 17th May 2018
"Unsecured Event"	as defined in respect of the National Electricity Transmission System and each of the Transmission Owner's Transmission Systems in the Licence Standards;
"Urgent STC Modification Proposal"	an urgent proposal to amend the Code proposed in accordance with Section B, sub-paragraph 7.2.6;
"Use of System Charging Methodology"	as defined in standard condition A1;
"User(s)"	any person (other than The Company or a Transmission Owner) who is authorised to generate, participate in the transmission of, distribute or supply electricity or who is included in a class of

person or persons which has been granted an exemption from section 6 of the Act and any person engaged in the sale or purchase of electricity or who otherwise purchases or acquires for purchase electricity;

“User”

any person (other than NGET or a Transmission Owner) who is authorised to generate, participate in the transmission of, distribute or supply electricity or who is included in a class of person or persons which has been granted an exemption from section 6 of the Act and any person engaged in the sale or purchase of electricity or who otherwise purchases or acquires for purchase electricity; The term User includes an EU Code User and a GB Code User.

"User Application"

an application made by a User to The Company under and pursuant to the CUSC in respect of:

- (a) a New Connection; or
- (b) a Modification; or
- (c) use of the National Electricity Transmission System; or
- (d) an Exchange Rate Request; or
- (e) a Request for a Statement of Works by such User.

"User Application Date"

the date of receipt by The Company of an effective User Application pursuant to the CUSC;

"User Commitment Methodology"

the methodology and principles as set out in CUSC Section 15;

"User Data"

information of or related to a User or Users including, without limitation, information about the business of a User, a User Site, User Works, User Outage or the operation or configuration of any User Equipment or User System.

"User Derogation"

a direction issued by the Authority relieving a User from the obligation under its Licence to comply with such parts of the Grid Code or any Distribution Code as may be specified in such direction, and "**Derogated**" shall be construed accordingly;

“User Equipment”

the Plant and Apparatus owned by a User (ascertained in the absence of agreement to the contrary by reference to the rules set out in Section D, Part One, paragraph 3) which: (a) is connected to the Transmission Connection Assets forming part of the National Electricity Transmission System at any particular Connection Site or New Connection Site to which that User

	wishes so to connect or (b) is connected to a Distribution System to which that User system wishes so to connect;
"User Outage"	a planned Outage of part or all of a User System or User Equipment;
"User Site"	a site owned (or occupied pursuant to a lease, licence or other agreement) by a User in which there is a Connection. For the avoidance of doubt, a site owned by The Company or a Transmission Owner but occupied by a User is a User Site;
"User System"	as defined in the CUSC as at Code Effective Date;
"User Works"	those works to be undertaken by a User which are necessary for installation of User Equipment [and in the case of OTSDUW Build, OTSUA] [and, in the case of OFTO Build, works and activities in respect of the prospective Transmission System] and which are specified for each Construction Project in the relevant TO Construction Agreement(s);
"Value Added Tax" "VAT"	has the meaning given to such term in the Value Added Tax Act 1994 and any tax of a similar nature which may be substituted for a levied in addition to it;
"Voltage Waveform Quality"	means the quality of voltage waveform on the National Electricity Transmission System taking account of harmonic content, phase unbalance and voltage fluctuations;
"Voltage Waveform Quality Assessment"	means an assessment of the impact of an offshore transmission system on Voltage Waveform Quality at an Interface Point;
"Week"	shall have the same meaning as the term "Week" is used in the Grid Code as at the Code Effective Date;
"Wider Cancellation Charge Information"	means the information required by The Company from each Transmission Owner to enable The Company to prepare the Annual Wider Cancellation Charge Statement being: <ul style="list-style-type: none"> (a) a Transmission Owners load related capex and non load related capex for the following Financial Year excluding the cost of any Attributable Works; and

- (b) a forecast of a Transmission Owners load related capex and non load related capex excluding the cost of any Attributable Works for the three Financial Years following the Financial Year referred to in (a) above.

“Wider Transmission Reinforcement Works”

those elements of the Transmission Reinforcement Works other than the Enabling Works which in relation to a particular Construction Project are defined as such by the Onshore Transmission Owner in its TO Construction Agreement;

"Withdrawal Date"

the date defined in Section B, paragraph 5.1.4 upon which the Withdrawing Party shall withdraw from the Framework Agreement;

"Withdrawal Notice"

the notice issued by a Party wishing to withdraw from the Framework Agreement as defined in Section B, sub-paragraph 5.1.2;

"Withdrawing Party"

a Party wishing to withdraw from the Framework Agreement in accordance with Section B, sub-paragraph 5.1.1;

“Workgroup”

a Workgroup established by the Committee pursuant to paragraph 7.2.4.A1

“Workgroup Report”

the report of a Workgroup in relation to a Proposed Amendment or any Alternative Amendment prepared pursuant to paragraph 7.2.4.A8

"Works"

as the context admits or requires, Transmission Construction Works, The Company Works and User Works.

SECTION K: TECHNICAL, DESIGN AND OPERATIONAL CRITERIA AND PERFORMANCE REQUIREMENTS FOR OFFSHORE TRANSMISSION SYSTEMS

1. INTRODUCTION

1.1 This Section K sets out the minimum technical, design and operational criteria and performance criteria that Offshore Transmission Owners must ensure their Transmission System can satisfy in the following specific areas:

1.2 Section D Part One, clause 2.2.6 of the STC specifies that in planning and developing its Transmission System, each Transmission Owner (which includes Offshore Transmission Owners) shall ensure that its Transmission System complies with the minimum technical, design and operational criteria and performance requirements set out or referred to in Connection Conditions 6.1, 6.2, 6.3 and 6.4 as applicable to Type 1 Transmission Owners or European Connection Conditions 6.1, 6.2, 6.3 and 6.4 as applicable to Type 2 Transmission Owners and in Planning Code 6.2 and/or 6.3 as applicable or such other technical criteria or requirements as apply to any relevant part of its Transmission System by virtue of a current Transmission Derogation and in the case of an Offshore Transmission System, each Transmission Owner shall ensure that its Transmission System meets the minimum technical design and operational criteria and performance requirements set out or referred to in section K of this code.

1.3 Annex 1 of Section K of the STC applies to:-

Offshore Transmission Owner's who own an AC Offshore Transmission System and that AC Offshore Transmission System was first connected to the Onshore Transmission System before 27 April 2019 and the purchase contracts for its Plant and Apparatus forming the major part of that AC Offshore Transmission System had been concluded before 17th May 2018; or Offshore Transmission Owner's who own an Offshore Transmission System comprising a Transmission DC Converter and that Offshore Transmission System was first connected to the Onshore Transmission System before 8 September 2019 and the purchase contracts for the Main Plant and Apparatus forming that Offshore Transmission System comprising a Transmission DC Converter had been concluded before 28 September 2018;

1.4 Annex 2 of Section K of the STC applies to:-

Offshore Transmission Owner's who own an AC Offshore Transmission System and that AC Offshore Transmission System was first connected to the Onshore Transmission System on or after 27 April 2019 and the purchase contracts for the Plant and Apparatus forming the major part of that AC Offshore Transmission System had been concluded on or after 17th May 2018; or Offshore Transmission Owner's who own an Offshore Transmission System and that Offshore Transmission System comprises one or more Transmission DC Converters and that Offshore Transmission System was first connected to the Onshore Transmission System on or after 8 September 2019 and the purchase contracts for the Main Plant and Apparatus forming that Offshore DC Transmission System had been concluded on or after 28 September 2018. For the avoidance of doubt, an Offshore Transmission System comprising one of more Transmission DC Converters would be assumed to constitute an HVDC System.

ANNEX 1

- 1.1 Annex 1 of Section K sets out the minimum technical, design and operational criteria and performance criteria that applies to:- Offshore Transmission Owner's who own an AC Offshore Transmission System and that AC Offshore Transmission System was first connected to the Onshore Transmission System before 27 April 2019 and the purchase contracts for the Plant and Apparatus forming the major part of that AC Offshore Transmission System had been concluded before 17th May 2018; or
- 1.2 Section D Part One, clause 2.2.6 of the STC specifies that in planning and developing its Transmission System, each Transmission Owner (which includes Offshore Transmission Owner's) shall ensure that its Transmission System complies with the minimum technical, design and operational criteria and performance requirements set out or referred to in Connection Conditions 6.1, 6.2, 6.3 and 6.4 and in Planning Code 6.2 and/or 6.3 as applicable or such other technical criteria or requirements as apply to any relevant part of its Transmission System by virtue of a current Transmission Derogation. For the avoidance of doubt, Offshore Transmission Owners in respect of their Offshore Transmission System, would be expected to meet the same requirements as GB Generators undertaking OTSDUW Build in respect of their Offshore Transmission Systems which includes Transmission DC Converters.
- 1.3 In addition to the above requirements each Offshore Transmission Owner must ensure their Offshore Transmission System can satisfy in the following specific areas:
 - 1.4.1 the reactive power capability deliverable at the Interface Point;
 - 1.4.2 the performance requirements of voltage control systems;
 - 1.4.3 Fault Ride Through Capability;
 - 1.4.4 additional damping facilities for any Transmission DC Converters;
 - 1.4.5 the provision of a **Frequency** signal to Users where necessary because of the use of Transmission DC Converters in an Offshore Transmission System;

- 1.4.6 operation under a range of System Frequencies;
 - 1.4.7 earthing arrangements for transformers; and
 - 1.4.8 the power quality requirements applicable at the Interface Point.
- 1.5 This Section K also provides for the Offshore Transmission Owner and The Company to co-operate in relation to the assessment of compliance.

2. REACTIVE CAPABILITY AND VOLTAGE CONTROL

- 2.1 All Offshore Transmission Systems must be capable of delivering Reactive Power at the Interface Point as described in paragraphs 2.2, 2.3 and 2.4 of Section K below. The Reactive Power capability that an Offshore Transmission System must be able to provide at the Interface Point may be delivered using a combination of Plant owned by the Offshore Transmission Owner concerned and Plant owned by a Generator or Generators connected to that Offshore Transmission System. Where Generator Plant is out of service, these Reactive Power capability requirements will be reduced pro rata to the maximum Active Power capability of Generator Plant in service.
- 2.2 All Offshore Transmission Systems must be capable of enabling the Offshore Transmission Owner to comply with an instruction received from The Company relating to a variation of the voltage set point at the Interface Point within 2 minutes of such instruction being received.

For Offshore Transmission Systems connected to a Distribution System where the Network Operator has confirmed to The Company that its System is restricted in accordance with Section KB2, clause 2.2 will not apply unless The Company can reasonably demonstrate that the magnitude of the available change in Reactive Power has a significant effect on voltage levels on the Onshore National Electricity Transmission System.

- 2.3 All Offshore Transmission Systems must be capable of transmitting Active Power equivalent to the Interface Point Capacity at any point between the limits 0.95 Power Factor lagging and 0.95 Power Factor leading at the Interface Point. The Reactive Power limits defined at the Interface Point Capacity:
- 2.3.1 at lagging Power Factor will apply to all Active Power transfer levels above 20% of the Interface Point Capacity as defined in Figure K1 below;

2.3.2 at leading Power Factor will apply at all Active Power transfer levels above 50% of the Interface Capacity as defined in Figure K1 below, and shall reduce linearly below 50% Active Power transfer as shown in figure K1 below unless the requirement to maintain the Reactive Power limits defined at the Interface Point Capacity at leading Power Factor down to 20% Active Power transfer is specified in the relevant Offshore TO Construction Agreement or Transmission Interface Site Specification.

2.4 When transferring Active Power equivalent to less than 20% of the Interface Point Capacity:

2.4.1 the automatic control system may continue to provide voltage control utilising any available reactive capability;

2.4.2 If voltage control is not being provided:

- (a) the automatic control system shall be designed to be capable of a smooth transition between the shaded area bounded by CD and the non-shaded area bound by AB in Figure K1 below; and
- (b) the Reactive Power delivered at the Interface Point shall be within a range of +/-5% of the Interface Point Capacity expressed in MVar.

Figure K1

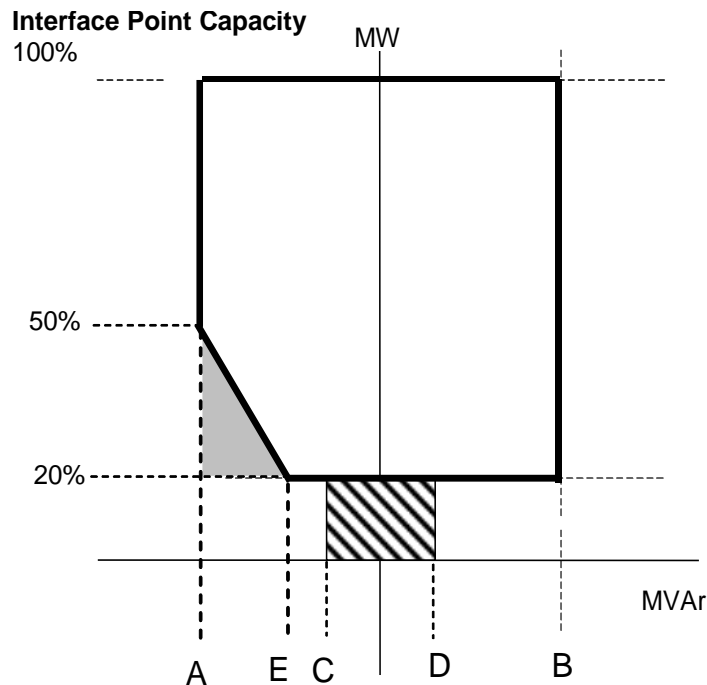

Point A is equivalent (in MVar) to 0.95 leading Power Factor at active power transfer equal to the Interface Point Capacity.

Point B is equivalent (in MVAR) to 0.95 lagging Power Factor active power transfer equal to the Interface Point Capacity.

Point C is equivalent (in MVAR) to -5% of active power transfer equal to the Interface Point Capacity.

Point D is equivalent (in MVAR) to +5% of active power transfer equal to the Interface Point Capacity.

Point E is equivalent (in MVAR) to -12% of active power transfer equal to the Interface Point Capacity.

- 2.5 Each Offshore Transmission System shall be capable of contribution to voltage control by continuous changes to the Reactive Power supplied at the Interface Point in accordance with the requirements specified in Appendix KB and without instability over the entire operating range of the Offshore Transmission System.
- 2.6 The requirement for additional voltage control facilities, including for example additional damping control facilities, where in The Company's view these are necessary for system reasons will be specified in the relevant Offshore TO Construction Agreement or Transmission Interface Site Specification.
- 2.7 Other control facilities, including constant Reactive Power output control modes (but excluding VAR limiters) are not required. However, if present in the voltage control system they will be disabled unless recorded in the relevant Offshore TO Construction Agreement or Transmission Interface Site Specification. Where an Offshore Transmission Owner retains the responsibility for the operation of such facilities such operation will only be in accordance with instructions to direct the configuration of the National Electricity Transmission System as given by The Company.
- 2.8 At the Interface Point the Active Power transfer from an Offshore Transmission System under steady state conditions should not be affected by voltage changes on the Onshore Transmission System in the Normal Operating Range by more than the change in Active Power losses at reduced or increased voltage. The Reactive Power output under steady state conditions should be fully available within the voltage range $\pm 5\%$ at 400kV, 275kV and 132kV.

3 FAULT RIDE THROUGH CAPABILITY

3.1 Fault Ride Through

- 3.1.1 For short circuit faults at Supergrid Voltage up to 140ms in duration:

- (a) each Offshore Transmission System shall remain connected to the remainder of the Total System at the Interface Point without tripping of any Plant and/or Apparatus comprising that Offshore Transmission System, for a close-up solid three-phase short circuit fault or any unbalanced short circuit fault on the Onshore Transmission System operating at Supergrid Voltages for a total fault clearance time of up to 140 ms. A solid three-phase or unbalanced earthed fault results in zero voltage on the faulted phase(s) at the point of fault. The duration of zero voltage is dependent on local protection and circuit breaker operating times. This duration and the fault clearance times will be specified in the relevant Offshore TO Construction Agreement or Transmission Interface Site Specification. Following fault clearance, recovery of the Supergrid Voltage to 90% on the Onshore Transmission System (which may include the Interface Point) may take longer than 140ms as illustrated in Appendix A Figures KA.1.1 (a) and (b);
- (b) each Offshore Transmission System shall be designed such that upon both clearance of the fault on the Onshore Transmission System as detailed in 3.1.1 (a) and within 0.5 seconds of the restoration of the voltage at the Interface Point to be within the Normal Operating Range Active Power transfer capability shall be restored to at least 90% of the level available immediately before the fault. During the period of the fault as detailed in 3.1.1 (a) each Offshore Transmission System shall generate maximum reactive current without exceeding the transient rating limit at the Interface Point; and
- (c) each Transmission DC Converter forming part of an Offshore Transmission System shall be designed to meet the Active Power recovery characteristics as specified in the relevant Offshore TO Construction Agreement Transmission Interface Site Specification upon clearance of the fault on the Onshore Transmission System as detailed in 3.1.1 (a).

3.1.2 For Supergrid Voltage dips greater than 140ms in duration, in addition to the requirements of 3.1.1 each Offshore Transmission System shall:

- (a) remain connected to the Onshore Transmission System without tripping of any Plant and/or Apparatus forming part of that Offshore Transmission System, for balanced Supergrid Voltage dips and associated durations on the Onshore Transmission System anywhere on or above the heavy black line shown in Figure K2. Appendix KA and Figures KA.1.3 (a), (b) and (c) provide an explanation and illustrations of Figure K2;

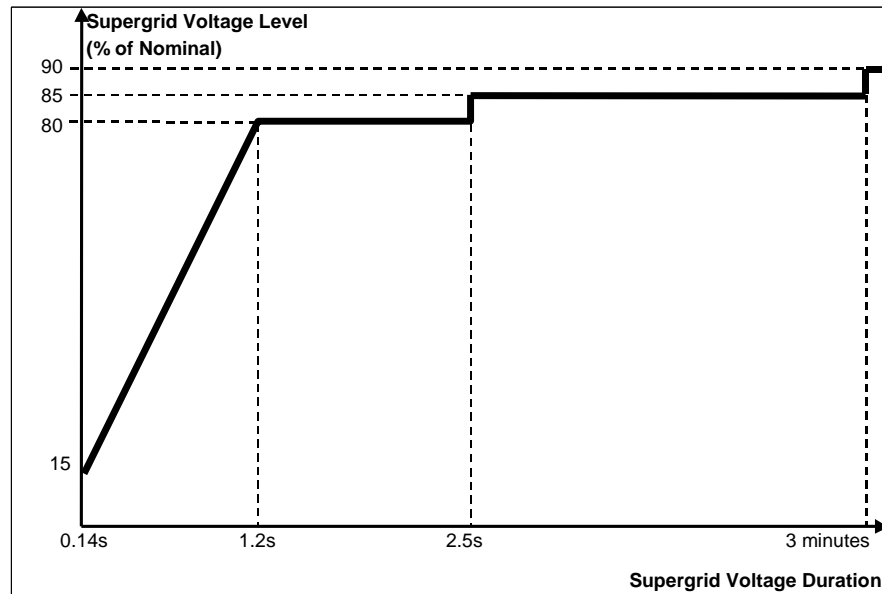

Figure K2

- (b) provide Active Power transfer capability, during Supergrid Voltage dips on the Onshore Transmission System as described in Figure K2, at least in proportion to the retained balanced voltage at the Interface Point except in the case where there has been a reduction in the Active Power transfer of the Offshore Transmission System in the time range in Figure K2, which has been caused by a reduction in the Active Power generated by any Generating Units connected to such an Offshore Transmission System. In addition, during the voltage dip, each Offshore Transmission System shall generate maximum reactive current at the Interface Point; and
- (c) restore Active Power transfer capability, following Supergrid Voltage dips on the Onshore Transmission System as described in Figure K2, within 1 second of restoration of the voltage at the Interface Point to be within the Normal Operating Range to at least 90% of the level available immediately before the occurrence of the dip except in the case of an Offshore Transmission System where there has been a reduction in the Intermittent Power Source of any Generating Units connected to such Offshore Transmission System in the time range in Figure K2 that restricts the Active Power transfer capability below this level.

3.1.3 In addition to meeting the requirements of Grid Code CC.6.1.5 (b) and CC.6.1.6 at the Interface Point, each Offshore Transmission System will be required to withstand, without tripping, the negative phase sequence loading incurred by clearance of a close-up phase-to-phase fault, by System Back-Up Protection on the Onshore Transmission System operating at Supergrid Voltage.

3.1.4 To avoid unwanted island operation, Offshore Transmission Systems connected to Onshore Systems in Scotland shall be tripped for the following conditions:

- (a) frequency above 52Hz for more than 2 seconds;
- (b) frequency below 47Hz for more than 2 seconds;
- (c) voltage as measured at the Interface Point is below 80% for more than 2.5 seconds; and
- (d) voltage as measured at the Interface Point is above 120% (115% for 275kV) for more than 1 second.

The times stated in (a) and (b) above are maximum trip times. Shorter times may be used to protect the integrity of an Offshore Transmission System or Power Stations connected to it.

4 ADDITIONAL DAMPING CONTROL FACILITIES FOR TRANSMISSION DC CONVERTERS

4.1 Offshore Transmission Owners must ensure that any Transmission DC Converters do not cause a sub-synchronous resonance problem on the Total System. Each Transmission DC Converter shall to be provided with sub-synchronous resonance damping control facilities.

4.2 Where specified in the relevant Offshore TO Construction Agreement or Transmission Interface Site Specification, each Transmission DC Converter forming part of an Offshore Transmission System is required to be provided with power oscillation damping or any other identified additional control facilities.

5. FREQUENCY CAPABILITES AND SIGNALS

5.1 Each Offshore Transmission Owner which utilises a Transmission DC Converter as part of the Offshore Transmission System shall provide to each User, in respect of its Offshore Power Station(s) connected to and/or using such Offshore Transmission System, a continuous signal indicating the real-time Frequency measured at the Interface Point.

5.2 The Frequency signal referred to in 5.1 above shall be provided to the Offshore Power Station in a manner and in timescales notified to the Offshore Transmission Owner by The Company through the relevant Offshore TO Construction Agreement or Transmission Interface Site Specification.

5.3 Each Offshore Transmission System which includes a Transmission DC Converter must be capable of:

- (a) continuously maintaining constant Active Power transfer for System Frequency changes within the range 50.5 to 49.5 Hz; and

- (b) (subject to the provisions of Grid Code CC.6.1.3) maintaining its Active Power transfer at a level not lower than the figure determined by the linear relationship shown in Figure 2 for System Frequency changes within the range 49.5 to 47 Hz, such that if the System Frequency drops to 47 Hz the Active Power transfer does not decrease by more than 5%.

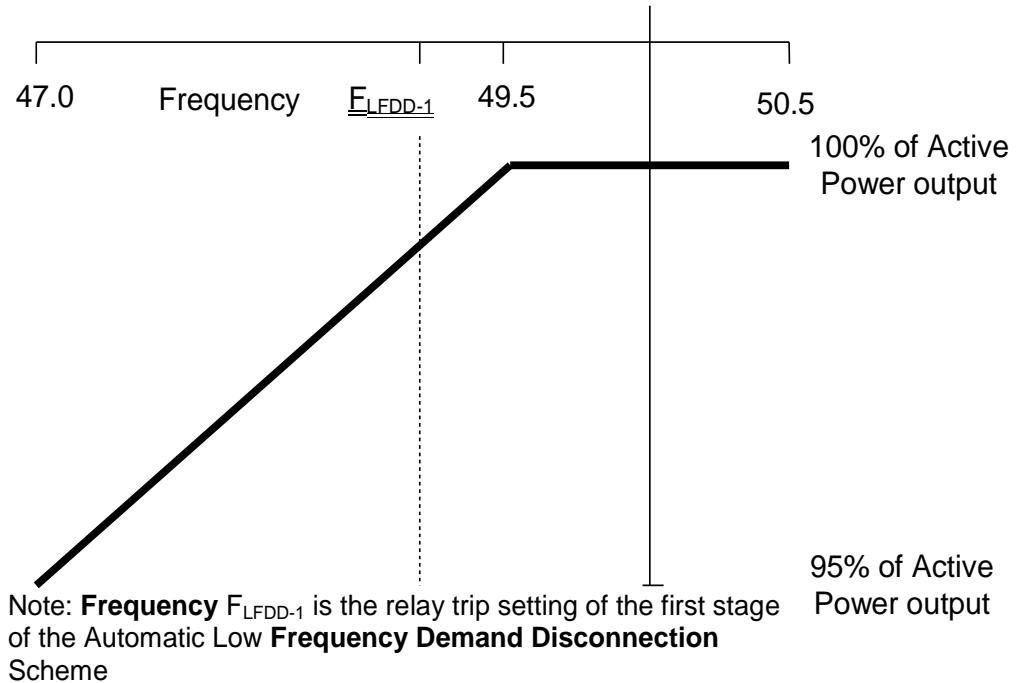

Figure K3

- 5.4 As stated in Grid Code CC.6.1.3, the System Frequency could rise to 52Hz or fall to 47Hz. Each Offshore Transmission System or any constituent element must be capable of:

5.4.1	<u>Frequency Range</u>	<u>Requirement</u>
	51.5Hz - 52Hz	Operation for a period of at least 15 minutes is required each time the Frequency is above 51.5Hz.
	51Hz - 51.5Hz	Operation for a period of at least 90 minutes is required each time the Frequency is above 51Hz.
	49.0Hz - 51Hz	Continuous operation is required
	47.5Hz - 49.0Hz	Operation for a period of at least 90 minutes is required each time the Frequency is below 49.0Hz.

- 5.4.2 47Hz - 47.5Hz Operation for a period of at least 20 seconds is required each occasion the Frequency is below 47.5Hz.

For the avoidance of doubt, disconnection, by frequency or speed based relays is not permitted within the frequency range 47.5Hz to 51.5Hz, unless The Company has agreed to any Frequency-level relays and/or rate-of-change-of Frequency relays which will trip such Offshore Transmission System and any constituent element within this Frequency range, under the relevant Offshore TO Construction Agreement or Transmission Interface Site Specification.

- 5.5 Offshore Transmission Owners will be responsible for protecting all their Transmission DC Converters against damage should Frequency excursions outside the range 52Hz to 47Hz ever occur. Should such excursions occur, it is up to the Offshore Transmission Owner to decide whether to disconnect their Apparatus for reasons of safety of Apparatus, Plant and/or personnel.

6. NEUTRAL EARTHING

- 6.1 At nominal System voltages of 132kV and above the higher voltage windings of any transformer comprising part of an Offshore Transmission System must be star connected with the star point suitable for connection to earth. The earthing and lower voltage winding arrangement shall be such as to ensure that the Earth Fault Factor requirement of paragraph Grid Code CC.6.2.1.1 (b) will be met on the National Electricity Transmission System at nominal System voltages of 132kV and above.

7. POWER QUALITY REQUIREMENTS

- 7.1 Each Offshore Transmission Owner is required to ensure that its Offshore Transmission System complies with the criteria set out in Section D, Part One, paragraph 2.2.6 in respect of any Interface Points.
- 7.2 Each Offshore Transmission Owner will carry out a Voltage Waveform Quality Assessment when designing its Offshore Transmission System and proposing any changes to the design of its Offshore Transmission System in accordance with Section D.

8. COMPLIANCE ASSESSMENT

- 8.1 Each Offshore Transmission Owner shall provide to The Company such information and assistance in relation to that Offshore Transmission Owner's Transmission System as required by The Company to enable The Company to undertake an assessment of the capability of the Offshore Transmission System to satisfy certain criteria as specified in this Section K. The Offshore Transmission Owner is responsible for carrying out any testing when requested by The Company and retains the responsibility for the safety of personnel and plant during test.

APPENDIX KA

FAULT RIDE THROUGH REQUIREMENT FOR OFFSHORE TRANSMISSION SYSTEMS

KA.1 SCOPE

KA.1.1 The fault ride through requirement is defined in Section K paragraphs 3.1. This Appendix provides illustrations by way of examples only of Section K paragraph 3.1.1(a) and further background and illustrations to Section K paragraph 3.1.2(a) and is not intended to show all possible permutations.

KA.2 SHORT CIRCUIT FAULTS AT SUPERGRID VOLTAGE UP TO 140MS IN DURATION

KA.2.2 For short circuit faults at Supergrid Voltage up to 140ms in duration on the Onshore Transmission System, the fault ride through requirement is defined in Section K paragraph 3.1.1 (a). Figures KA.1.1 (a) and (b) illustrate two typical examples of voltage recovery for short-circuit faults cleared within 140ms by two circuit breakers (a) and three circuit breakers (b) respectively.

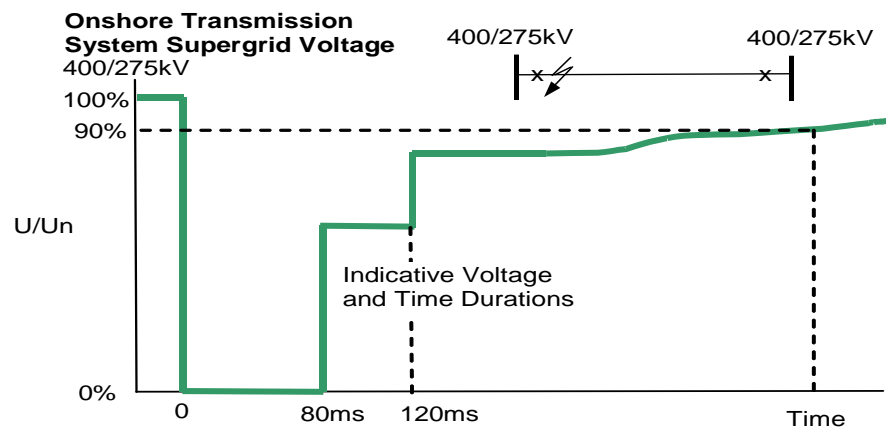

Figure KA.1.1 (a)

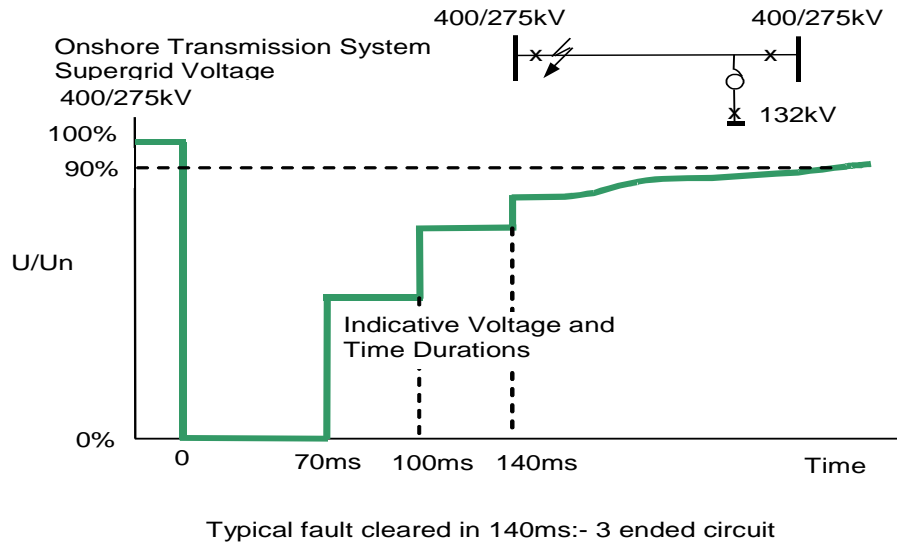

Figure KA.1.1 (b)

KA.3 SUPERGRID VOLTAGE DIPS GREATER THAN 140MS IN DURATION

KA.3.1 For balanced Supergrid voltage dips on the Onshore Transmission System having durations greater than 140ms and up to 3 minutes the fault ride through requirement is defined in Section K paragraph 3.1.2 (a) and Figure K2 which is reproduced in this Appendix as Figure KA.1.2 and termed the voltage–duration profile.

KA.3.2 This profile is not a voltage-time response curve that would be obtained by plotting the transient voltage response at a point on the Onshore Transmission System to a disturbance. Rather, each point on the profile (i.e. the heavy black line) represents a voltage level and an associated time duration which connected Offshore Transmission Systems must withstand or ride through.

KA.3.3 Figures KA.1.3 (a), (b) and (c) illustrate the meaning of the voltage-duration profile for voltage dips having durations greater than 140ms.

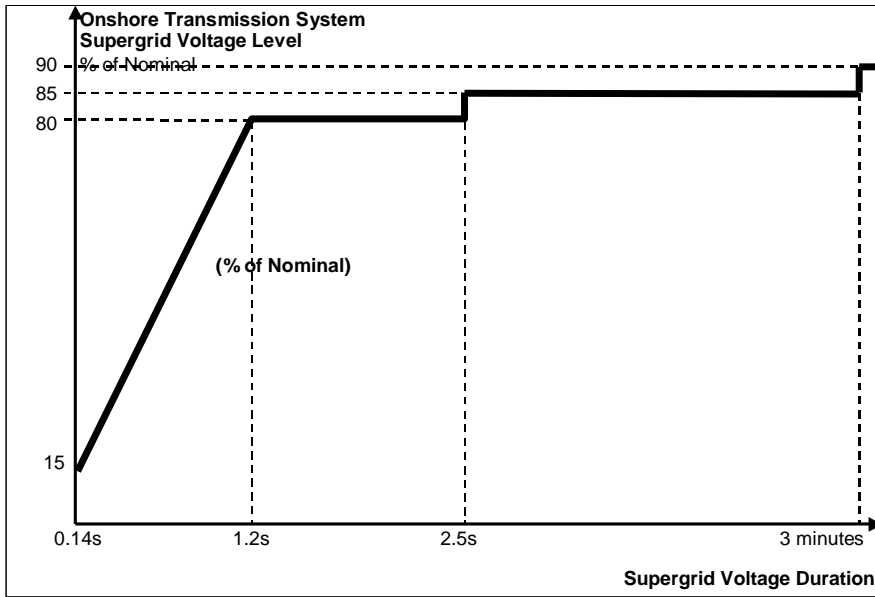
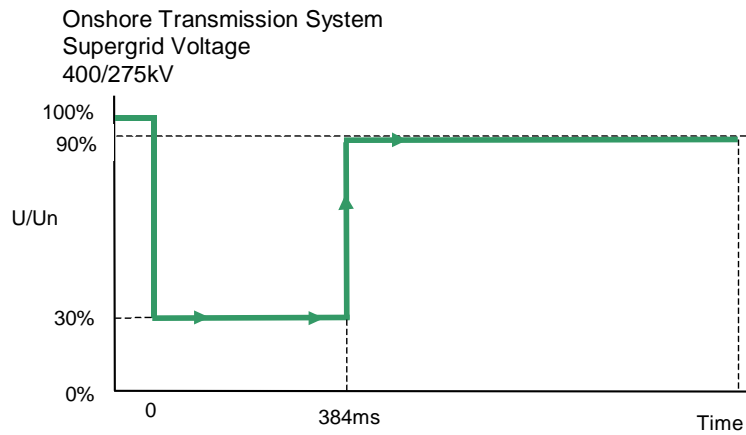
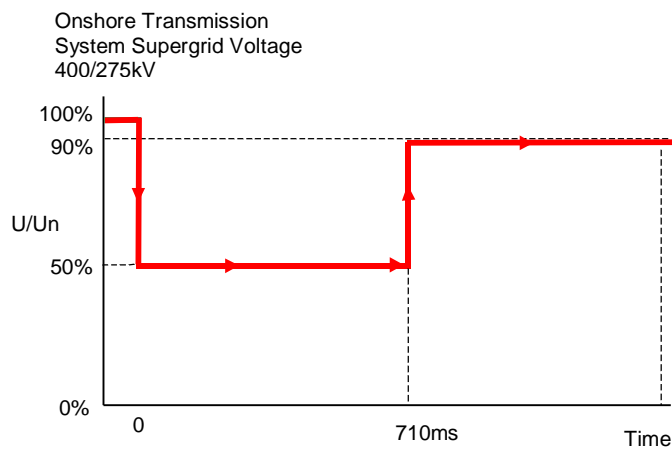

Figure KA.1.2



30% retained voltage, 384ms duration

Figure KA.1.3(a)



50% retained voltage, 710ms duration

Figure KA.1.3(b)

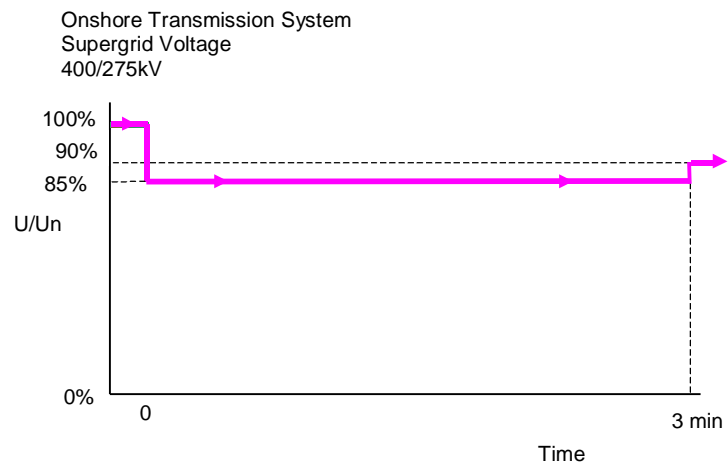

85% retained voltage, 3 minutes duration

Figure KA.1.3(c)

APPENDIX KB

PERFORMANCE REQUIREMENTS FOR CONTINUOUSLY ACTING AUTOMATIC VOLTAGE CONTROL SYSTEMS FOR OFFSHORE TRANSMISSION SYSTEMS

KB.1 SCOPE

KB.1.1 This Appendix sets out the performance requirements of continuously acting automatic voltage control systems for Offshore Transmission Systems that must be complied with by the owner of such an Offshore Transmission System. This Appendix does not limit any site specific requirements that may be included in an Offshore TO Construction Agreement or Transmission Interface Site Specification where in The Company's reasonable opinion these facilities are necessary for system reasons.

KB.2 REQUIREMENTS

KB.2.1 The Company requires that the continuously acting automatic voltage control system for the Offshore Transmission System shall meet the following functional performance specification. If a Network Operator has confirmed to The Company that its network to which an Embedded Offshore Transmission System is connected is restricted such that the full reactive range under the steady state voltage control requirements (KB.3) cannot be utilised, The Company may specify in the relevant TO Construction Agreement or Transmission Interface Site Specification alternative limits to the steady state voltage control range that reflect these restrictions.

KB.3 STEADY STATE VOLTAGE CONTROL

KB.3.1 The Offshore Transmission System shall provide continuous steady state control of the voltage at the Interface Point with a Setpoint Voltage and Slope characteristic as illustrated in Figure KB.3 (a).

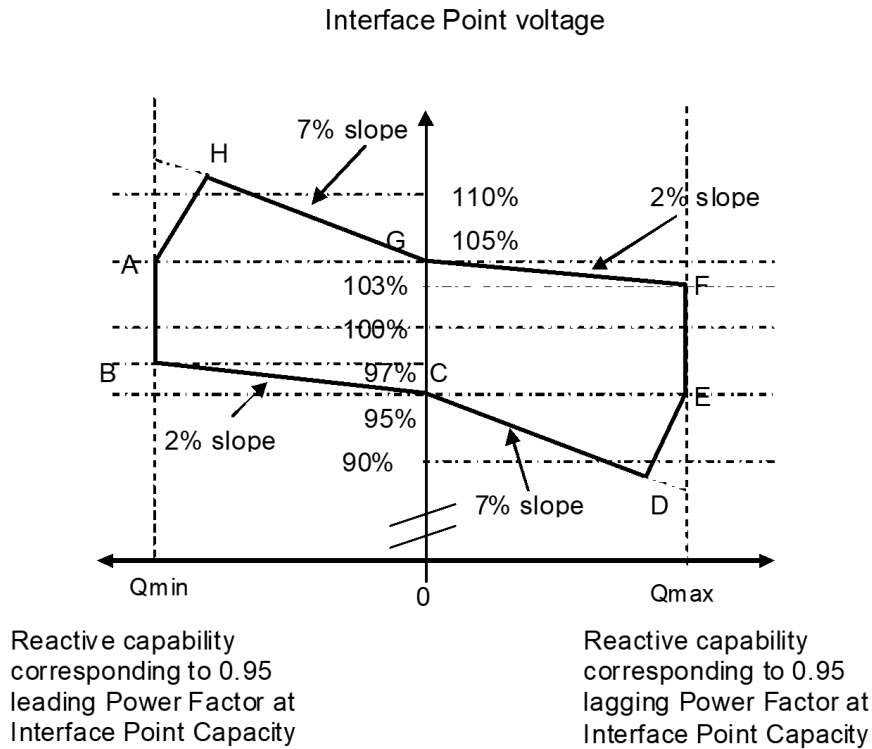

Figure KB.3 (b)

KB.3.4 Figure KB.3 (b) shows the required envelope of operation for Offshore Transmission Systems. The enclosed area within points ABCDEFGH is the required capability range within which the Slope and Setpoint Voltage can be changed.

KB.3.5 Should the operating point of the Offshore Transmission System deviate so that it is no longer a point on the operating characteristic (figure KB.3 (a)) defined by the target Setpoint Voltage and Slope, the continuously acting automatic voltage control system shall act progressively to return the value to a point on the required characteristic within 5 seconds.

KB.3.6 Should the Reactive Power output of the Offshore Transmission System reach its maximum lagging limit at an Interface Point voltage above 95%, the Offshore Transmission System shall maintain maximum lagging Reactive Power output for voltage reductions down to 95%. This requirement is indicated by the line EF in figure KB.3 (b). Should the Reactive Power output of the Offshore Transmission System reach its maximum leading limit at an Interface Point voltage below 105%, the Offshore Transmission System shall maintain maximum leading Reactive Power output for voltage increases up to 105%. This requirement is indicated by the line AB in figure KB.3 (b).

KB.3.7 For Interface Point voltages below 95%, the lagging Reactive Power capability of the Offshore Transmission System should be that which results from the supply of maximum lagging reactive current whilst ensuring the current remains within design operating limits. An example of the capability is shown by the line DE in figure KB.3 (b). For Interface Point voltages above 105%, the leading Reactive Power capability of the Offshore Transmission System should be that which results from the supply of

maximum leading reactive current whilst ensuring the current remains within design operating limits. An example of the capability is shown by the line AH in figure KB.3 (b). Should the Reactive Power output of the Offshore Transmission System reach its maximum lagging limit at an Interface Point voltage below 95%, the Offshore Transmission System shall maintain maximum lagging reactive current output for further voltage decreases. Should the Reactive Power output of the Offshore Transmission System reach its maximum leading limit at an Interface Point voltage above 105%, the Offshore Transmission System shall maintain maximum leading Reactive Power output for further voltage increases.

KB.4 TRANSIENT VOLTAGE CONTROL

KB.4.1 For an on-load step change in Interface Point voltage, the continuously acting automatic control system shall respond according to the following minimum criteria:

KB.4.1.1 the Reactive Power output response of the Offshore Transmission System shall commence within 0.2 seconds of the application of the step. It shall progress linearly although variations from a linear characteristic shall be acceptable provided that the MVA_r seconds delivered at any time up to 1 second are at least those that would result from the response shown in figure KB.4;

KB.4.1.2 the response shall be such that, for a sufficiently large step, 90% of the full reactive capability of the Offshore Transmission System, as required by Section K, paragraph 2.3 (or, if appropriate, KB.3.6 or KB.3.7), will be produced within 1 second

KB.4.1.3 the magnitude of the Reactive Power output response produced within 1 second shall vary linearly in proportion to the magnitude of the step change

KB.4.1.4 the settling time shall be no greater than 2 seconds from the application of the step change in voltage and the peak to peak magnitude of any oscillations shall be less than 5% of the change in steady state Reactive Power within this time.

KB.4.1.5 following the transient response, the conditions of KB3 apply.

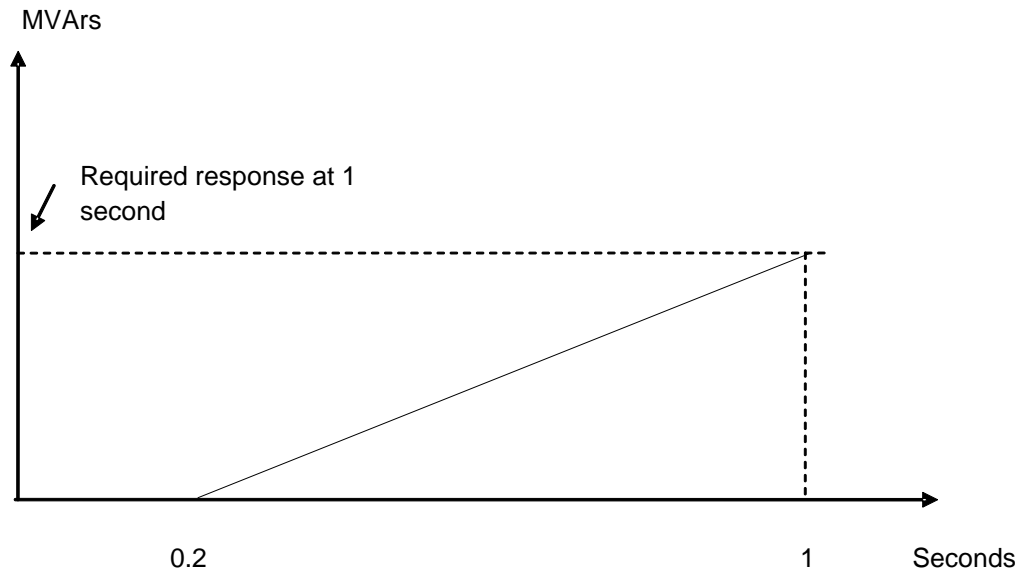

Figure KB.4

KB.5 POWER OSCILLATION DAMPING

KB.5.1 The requirement for the continuously acting voltage control system to be fitted with a Power System Stabiliser (PSS) shall be specified in the relevant Offshore TO Construction Agreement or Transmission Interface Site Specification if, in The Company's view, this is required for system reasons. However if a Power System Stabiliser is included in the voltage control system its settings and performance shall be agreed with The Company and commissioned in accordance with STCP19-4.

KB.6 OVERALL VOLTAGE CONTROL SYSTEM CHARACTERISTICS

KB.6.1 The continuously acting automatic voltage control system is required to respond to minor variations, steps, gradual changes or major variations in Interface Point voltage.

KB.6.2 The overall voltage control system shall include elements which provide a limited bandwidth output. The bandwidth limiting must be consistent with the speed of response requirements and ensure that the highest frequency of response cannot excite torsional oscillations on other plant connected to the network. A bandwidth of 0-5Hz would be judged to be acceptable for this application. All other control systems employed within the Offshore Transmission System should also meet this requirement

KB.6.3 The response of the voltage control system (including the Power System Stabiliser if employed) shall be demonstrated by applying suitable step disturbances into the voltage control system of the Offshore Transmission System, or by changing the actual voltage at a suitable point as specified by The Company. The damping shall be judged to be adequate if the corresponding Active Power response to the disturbances decays within 2 seconds of the application of the step.

ANNEX 21.1 Annex 2 of Section K sets out the minimum technical, design and operational criteria and performance criteria that applies to:-

Offshore Transmission Owner's who own an AC Offshore Transmission System and that AC Offshore Transmission System was first connected to the Onshore Transmission System on or after 27 April 2019 and the purchase contracts for the Plant and Apparatus forming the major part of that AC Offshore Transmission System had been concluded on or after 17th May 2018; or

Offshore Transmission Owner's who own an Offshore Transmission System and that Offshore Transmission System comprises one or more Transmission DC Converters and that Offshore Transmission System was first connected to the Onshore Transmission System on or after 8 September 2019 and the purchase contracts for the Main Plant and Apparatus forming that Offshore DC Transmission System had been concluded on or after 28 September 2018. For the avoidance of doubt, an Offshore Transmission System comprising one or more Transmission DC Converters would be assumed to constitute an HVDC System.

- 1.2 Section D Part One, clause 2.2.6 of the STC specifies that in planning and developing its Transmission System, each Type 2 Transmission Owner (which includes Offshore Transmission Owner's) shall ensure that its Transmission System complies with the minimum technical, design and operational criteria and performance requirements set out or referred to in European Connection Conditions 6.1, 6.2, 6.3 and 6.4 and in Planning Code 6.2 and/or 6.3 as applicable or such other technical criteria or requirements as apply to any relevant part of its Transmission System by virtue of a current Transmission Derogation. For the avoidance of doubt, Offshore Transmission Owners in respect of their Offshore Transmission System, would be expected to meet the same requirements as EU Generators undertaking OTSDUW Build in respect of their Offshore Transmission Systems which includes Transmission DC Converters including HVDC Systems.
- 1.3 In addition to the above requirements each Offshore Transmission Owner must ensure their Offshore Transmission System can satisfy in the following specific areas:
 - 1.3.1 In all cases, where an obligation is placed on a EU Generator undertaking OTSDUW Build (which includes those with Transmission DC Converters and HVDC Systems) any site specific requirements being pursuant to the Bilateral Agreement, to be placed upon the Offshore Transmission Owner would be specified in the Offshore Transmission Owner Construction Agreement or Transmission Interface Site Specification.
 - 1.3.2 The Reactive Capability requirements at the Interface Point applicable to Offshore Transmission Licensees are the same as EU Generators undertaking OTSDUW Build as defined in ECC.6.3.2.4. The Reactive Power capability that an Offshore Transmission System must be able to provide at the Interface Point may be delivered using a combination of Plant owned by the Offshore Transmission Owner concerned and Plant owned by a Generator or Generators connected to that Offshore Transmission System. Where Generator Plant is out of service, the Reactive Power capability requirements will be reduced pro-rata to the maximum Active Power capability of Generator Plant in service.

- 1.3.3 All Offshore Transmission Systems must be capable of enabling the Offshore Transmission Owner to comply with an instruction received from The Company relating to a variation on the voltage setpoint at the Interface Point within 2 minutes of such instruction being received.
- 1.3.4 Control facilities, including constant Reactive Power output control modes (but excluding VAR limiters) are not required. However, if present in the voltage control system they will be disabled unless recorded in the relevant Offshore TO Construction Agreement or Transmission Interface Site Specification. Where an Offshore Transmission Owner retains the responsibility for the operation of such facilities such operation will only be in accordance with instructions to direct the configuration of the National Electricity Transmission System as given by The Company.
- 1.3.5 Each Transmission Owner which utilises a Transmission DC Converter as part of the Offshore Transmission System shall provide to each User, in respect of its Offshore Power Station(s) connected to and/or using such Offshore Transmission System, a continuous signal indicating the real-time Frequency measured at the Interface Point as required under ECC.6.3.3 (f) of the Grid Code.
- 1.3.6 Each Transmission Owner which utilises a Transmission DC Converter as part of its Offshore Transmission System shall be required to satisfy the applicable requirements of ECC.6.3.6.1.2, ECC.6.3.7, ECC.6.3.12 and ECC.6.3.13 with any site specific requirements being specified in the Offshore Transmission Owner Construction Agreement or Transmission Interface Site Specification.
- 1.3.7 Each Transmission Owner which utilises a Transmission DC Converter as part of its Offshore Transmission System shall be required to satisfy the applicable requirements of ECC.6.3.17 with any site specific requirements being specified in the Offshore Transmission Owner Construction Agreement or Transmission Interface Site Specification.
- 1.3.8 Each Offshore Transmission System which includes a Transmission DC Converter (including and HVDC System) must be capable of:
- (a) continuously maintaining constant Active Power transfer for System Frequency changes within the range 50.5 to 49.5 Hz; and
 - (b) (subject to the provisions of Grid Code ECC.6.1.2) maintaining its Active Power transfer at a level not lower than the figure determined by the linear relationship shown in Figure K3 for System Frequency changes within the range 49.5 to 47 Hz, such that if the System Frequency drops to 47 Hz the Active Power transfer does not decrease by more than 5%.

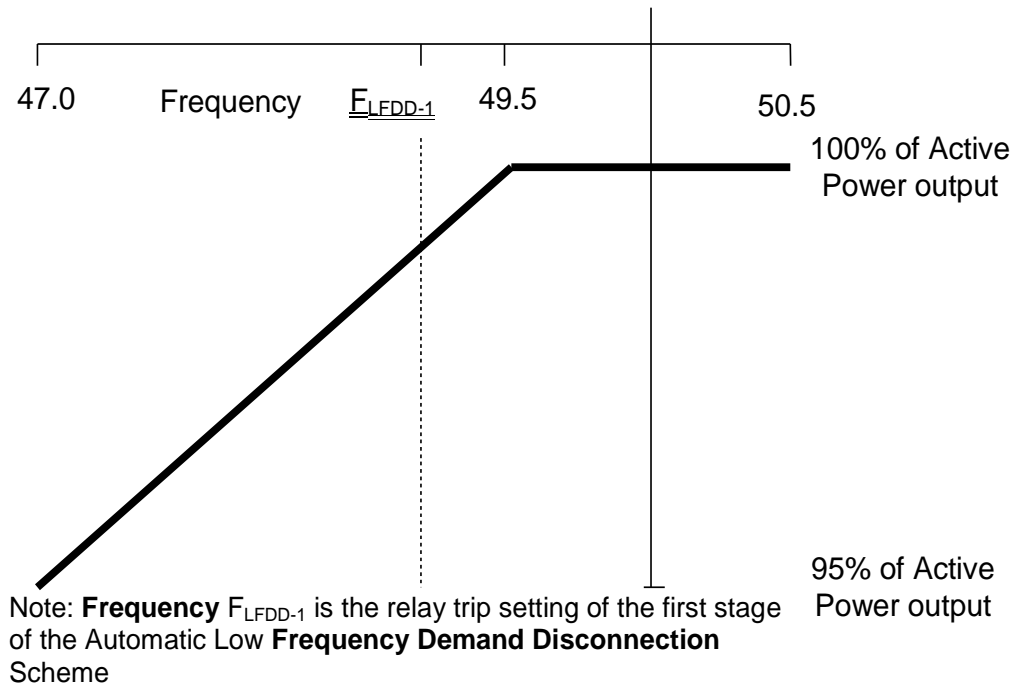

Figure K4

- 1.3.9 All Offshore Transmission Systems must be capable of enabling the Offshore Transmission Owner to comply with the requirements of ECC.6.5.6. In addition, Offshore Transmission Owners shall be required to satisfy the applicable requirements of ECC.6.6 with any detailed requirements being specified in the Offshore Transmission Owner Construction Agreement or Transmission Interface Site Specification.
- 1.4 Each Offshore Transmission Owner is required to comply with the requirements of the European Compliance Processes (ECP's) as applicable to EU Generators undertaking OTSDUW Build. For the avoidance of doubt, this would include Offshore Transmission Owners in respect of Transmission DC Converters including HVDC Systems as applicable. Each Offshore Transmission Owner shall provide to The Company such information and assistance in relation to that Offshore Transmission Owner's Transmission System as required by The Company to enable The Company to undertake an assessment of the capability of the Offshore Transmission System to satisfy certain criteria as specified in this section K.

SCHEDULE ONE

THE SYSTEM OPERATOR - TRANSMISSION OWNER CODE

ACCESSION AGREEMENT

- (1) NATIONAL GRID ELECTRICITY SYSTEM OPERATOR LIMITED;
and
- (2) [COMPANY NAME]

**THE SYSTEM OPERATOR - TRANSMISSION OWNER CODE
ACCESSION AGREEMENT**

Framework Agreement (howsoever expressed) should be read and construed as reference to the Framework Agreement and this Accession Agreement.

6. If any provision of this Accession Agreement is or becomes invalid, unenforceable or illegal or is declared to be invalid, unenforceable or illegal by any court of competent jurisdiction or by any other Competent Authority (as defined in the STC), such invalidity, unenforceability or illegality shall not prejudice or affect the remaining provisions of this Accession Agreement, which shall continue in full force and effect notwithstanding the same. The Party Applicant and The Company (acting on its own behalf and on behalf of each of the other Parties) hereby acknowledge and agree for the purposes of the Contracts (Rights of Third Parties) Act 1999 that no rights, powers or benefits are or shall be conferred on any person pursuant to this Accession Agreement, except for such rights, powers or benefits as are expressly conferred on the Parties and the Party Applicant in accordance with and subject to its terms or except for or to the extent provided in the STC.
7. This Accession Agreement may be executed in counterparts.
8. This Accession Agreement shall be governed by and construed in accordance with the laws of England and Wales and the parties hereby submit to the jurisdiction of the courts of England and Wales and the courts of Scotland only.
9. If Party Applicant is a company which is incorporated under the Companies Act 1985 (as amended), its address for service shall be its registered office. If the Party Applicant is not a company incorporated under the Companies Act 1985 (as amended) it shall provide to The Company an address in Great Britain for service of process on its behalf in any proceedings, provided that if any such Party Applicant fails at any time to provide such address, such Party Applicant shall be deemed to have appointed The Company as its agent to accept service of process on its behalf until and unless such Party Applicant provides The Company with an alternative address in Great Britain for these purposes.

AS WITNESS the hands of the duly authorised representatives of the parties hereto the day and year first above written.

For and behalf of: [COMPANY NAME]

Signed by:

Name:

For and behalf of: NATIONAL GRID ELECTRICITY SYSTEM OPERATOR LIMITED

Signed by:

Name:

END OF SCHEDULE ONE

SCHEDULE TWO

LIST OF CODE PROCEDURES

Number	Title	Issue	Effective Date
STCP 01-1	Operational Switching	Issue 008	30 July 2014
STCP 02-1	Alarm and Event Management	Issue 005	3 December 2014
STCP 03-1	Post Event Analysis and Reporting	Issue 005	18 December 2009
STCP 04-1	Real Time Data Change Management	Issue 005	26 February 2014
STCP 04-2	Real Time Datalink Management	Issue 005	26 February 2014
STCP 04-3	Real Time Data Provision	Issue 005	23 February 2016
STCP 04-4	Provision of Asset Operational Information	Issue 004	24 June 2009
STCP 04-5	Operational Telephony	Issue 004	24 June 2009
STCP 04-6	Offshore Datalink Functional Specification	Issue 002	25 November 2013
STCP 06-1	Black Start	Issue 005	19 May 2016
STCP 06-2	De-synchronised Island Management	Issue 004	18 December 2009
STCP 06-3	System Incident Management	Issue 004	30 September 2010
STCP 06-4	Contingency Arrangements	Issue 004	18 December 2009
STCP 08-1	Protection Testing	Issue 004	24 June 2009
STCP 08-2	Circuit Live Trip and DAR Tests	Issue 004	24 June 2009
STCP 08-3	Operational Tests and System Tests	Issue 004	18 December 2009
STCP 08-4	User Tests	Issue 004	18 December 2009
STCP 09-1	Safety Co-ordination between Parties	Issue 004	28 July 2009
STCP 09-2	Public and Site Safety	Issue 005	24 June 2009
STCP 10-1	Asset Nomenclature	Issue 004	24 June 2009
STCP 11-1	Outage Planning	Issue 006	07 October 2011
STCP 11-2	Outage Data Exchange	Issue 006	10 August 2016
STCP 11-3	TO Outage Change Costing	Issue 004	18 December 2009
STCP 12-1	Data Exchange Mechanism	Issue 004	12 January 2011
STCP 13-1	Invoicing and Payment	Issue 007	20 November 2013
STCP 14-1	Data Exchange for Charge Setting	Issue 007	20 November 2013
STCP 14-2	Data Requirements for Charging Consultations	Issue 003	18 September 2009
STCP 14-3	Customer Charging Enquiries	Issue 003	18 September 2009
STCP 16-1	Investment Planning	Issue 005	19 May 2016
STCP 17-1	Feasibility Study	Issue 003	18 December 2009
STCP 18-1	Connection and Modification Application	Issue 005	19 May 2016
STCP 18-2	Use of System Application	Issue 003	18 December 2009
STCP 18-3	TEC Changes	Issue 006	18 December 2009
STCP 18-4	Request for a Statement of Works	Issue 002	18 December 2009
STCP 18-6	Variation to Agreements	Issue 004	18 December 2009
STCP 19-2	Construction Process and Scheme Closure	Issue 005	03 March 2010
STCP 19-3	Operational Notification & Compliance Testing	Issue 005	25 November 2013
STCP 19-4	Commissioning and Decommissioning	Issue 006	30 March 2015
STCP 19-5	Offshore Transmission System Compliance Process & Testing	Issue 002	10 August 2016
STCP 19-6	Application Fee	Issue 005	29 January 2014
STCP 20-1	Electricity Ten Year Statement	Issue 004	10 August 2016
STCP 21-1	Network Options Assessment	Issue 002	10 August 2016
STCP 22-1	Production of Models for GB System Planning	Issue 002	14 February 2012
STCP 23-1	Offshore Party Entry Process	Issue 001	18 December 2009
STCP 24-1	Revenue Forecast Information Provision	Issue 002	04 November 2015
STCP 25-1	Significant Code Review Process	Issue 001	20 November 2013
STCP 25-2	Send Back Process	Issue 001	20 November 2013
STCP 25-3	Fast Track Self Governance Process	Issue 001	20 November 2013
STCP 26-1	Active Network Management	Issue 001	04 November 2015
STCP 22-1	Production of Models for GB System Planning	Issue 003	23 March 2017
STCP18-2	Process Improvement Process Administration	Issue 004	23 May 2017

STCP18-3	Process Improvement	Issue 007	23 May 2017
STCP08-2	Housekeeping Modification to re-insert missing	Issue 005	07 June 2017
STCP18-1	Connection and Modification Application	Issue 006	25 July 2017
STCP18-4	Statement of Works Issue	Issue 003	25 July 2017
STCP19-3	Operational Notification & Compliance Testing	Issue 006	25 June 2018
STCP09-1	Safety Co-ordination Between Parties	Issue 005	25 June 2018
STCP13-2	SIF and LARF Methodology	Issue 001	09 July 2018
STCP27-01	System Performance Monitoring	Issue 001	22 February 2019
STCP03-1	Post Event Analysis and Reporting	Issue 006	01 April 2019
STCP04-1	Real time Data Change Management	Issue 006	01 April 2019
STCP04-2	Real time Datalink Management	Issue 006	01 April 2019
STCP04-4	Provision of Asset Operational Information	Issue 005	01 April 2019
STCP04-6	Offshore Datalink Function Spec for Telecontrol Communications Interface	Issue 003	01 April 2019
STCP06-2	De-synchronised Island Management	Issue 005	01 April 2019
STCP06-4	Contingency Arrangements	Issue 005	01 April 2019
STCP08-1	Protection Testing	Issue 005	01 April 2019
STCP08-3	Operation Tests and System Tests	Issue 005	01 April 2019
STCP08-4	User Tests	Issue 005	01 April 2019
STCP09-1	Safety Co-ordination between Parties	Issue 005	01 April 2019
STCP10-1	Asset Nomenclature	Issue 005	01 April 2019
STCP11-3	TO Outage change costing	Issue 005	01 April 2019
STCP13-1	Invoicing and Payment	Issue 008	01 April 2019
STCP14-1	Data Exchange for Charge Setting	Issue 008	01 April 2019
STCP14-2	Data Exchange for Charging Consultations	Issue 004	01 April 2019
STCP14-3	Customer Charging Enquires	Issue 004	01 April 2019
STCP16-1	Investment Planning	Issue 006	01 April 2019
STCP17-1	Feasibility Study	Issue 004	01 April 2019
STCP18-1	Connection and Modification Application	Issue 007	01 April 2019
STCP18-2	Use of System Application	Issue 005	01 April 2019
STCP18-3	TEC Changes	Issue 008	01 April 2019
STCP18-4	Request for a Statement of Works	Issue 004	01 April 2019
STCP18-6	Variations to Agreements	Issue 005	01 April 2019
STCP19-2	Construction Process and Scheme Closure	Issue 006	01 April 2019
STCP19-3	Operational Notification and Compliance Testing	Issue 006	01 April 2019
STCP19-4	Commissioning and Decommissioning	Issue 007	01 April 2019
STCP19-5	Offshore Transmission System Compliance Process and Testing	Issue 003	01 April 2019
STCP19-6	Application Fee	Issue 006	01 April 2019
STCP20-1	Electricity Ten Year Statement	Issue 005	01 April 2019
STCP21-1	Network Options Assessment	Issue 004	01 April 2019
STCP23-1	Offshore Party Entry Process	Issue 002	01 April 2019
STCP24-1	Revenue Forecast Information Provision	Issue 003	01 April 2019
STCP25-1	Significant Code Review Process	Issue 002	01 April 2019
STCP25-2	Send Back Process	Issue 002	01 April 2019
STCP25-3	Fast Track Self Governance Process	Issue 005	01 April 2019
STCP26-1	Active Network Management	Issue 002	01 April 2019
STCP01-1	Operation Switching	Issue 009	01 April 2019
STCP02-1	Alarm and Event Management	Issue 006	01 April 2019
STCP04-3	Real Time Data Provision	Issue 006	01 April 2019
STCP04-5	Operational Telephony	Issue 006	01 April 2019
STCP06-1	Black Start	Issue 006	01 April 2019
STCP06-3	System Incident Management	Issue 005	01 April 2019
STCP08-2	Circuit Live Trip & DAR Testing	Issue 006	01 April 2019
STCP09-2	Site public and Environmental Safety	Issue 006	01 April 2019
STCP11-1	Outage Planning	Issue 007	01 April 2019

STCP11-2	Outage Data Exchange	Issue 007	01 April 2019
STCP12-1	Data Exchange Mechanism	Issue 005	01 April 2019
STCP19-3	Operational Notification & Compliance Testing	Issue 007	01 April 2019
STCP09-1	Safety Co-ordination between Parties	Issue 006	01 April 2019
STCP13-2	SIF and LARF Methodology	Issue 002	01 April 2019
STCP27-01	System Performance Monitoring	Issue 002	01 April 2019
STCP18-1	Connection and Modification Application	Issue 008	13 May 2019
STCP18-2	Use of System Application	Issue 005	13 May 2019
STCP18-3	TEC Changes	Issue 009	13 May 2019
STCP18-4	Request for a Statement of Works	Issue 005	13 May 2019
STCP18-6	Variation to Agreements	Issue 006	13 May 2019
STCP18-1	Connection and Modification Application	Issue 009	1 August 2019
STCP19-3	Operational Notification & Compliance Testing	Issue 008	1 August 2019
STCP04-3	Real Time Data Provision	Issue 007	1 August 2019
STCP21-2	Network Asset Risk Metric (NARM) Data Exchange	Issue 001	3 February 2020
STCP14-1	Data Exchange for Charge Setting	Issue 009	5 August 2020
STCP13-1	Invoicing and Payment	Issue 009	1 September 2020
STCP13-1	Invoicing and Payment	Issue 0010	29 October 2020
STCP14-1	Data Exchange for Charge Setting	Issue 0010	29 October 2020
STCP19-6	Application Fee	Issue 007	29 October 2020
STCP24-1	Revenue Forecast Information Provision	Issue 004	29 October 2020
STCP18-1	Connection and Modification Application	Issue 0010	31 December 2020
STCP11-4	Enhanced Service Provision	Issue 002	1 April 2021
STCP13-1	Invoicing & Payment	Issue 0011	01 July 2021
STCP14-1	Data Exchange for Charge Setting	Issue 0011	01 July 2021
STCP24-1	Revenue Forecast Information Provision	Issue 005	01 July 2021
STCP02-1	Alarm and Event	Issue 007	06 April 2022
STCP06-3	System Incident Management	Issue 006	06 April 2022
STCP06-4	Contingency Arrangements	Issue 006	06 April 2022
STCP17-1	Feasibility Study	Issue 005	06 April 2022
STCP18-1	Connection and Modification Application	Issue 0010	06 April 2022
STCP18-2	Use of System Application	Issue 007	06 April 2022
STCP19-3	Operational Notification Compliance Testing	Issue 009	06 April 2022
STCP19-4	Commissioning and Decommissioning	Issue 008	06 April 2022
STCP19-5	Offshore Compliance Process Testing	Issue 006	06 April 2022
STCP19-6	Application Fee	Issue 008	06 April 2022
STCP19-5	Offshore Transmission System Compliance Process and Testing	Issue 005	24 June 2022
STCP01-1	Operational Switching	Issue 0011	25 April 2023
STCP02-1	Alarm Event 006 Alarm and Event Management	Issue 008	25 April 2023
STCP03-1	Post Event Analysis and Reporting	Issue 007	25 April 2023
STCP04-1	Real Time Data Change Management	Issue 007	25 April 2023
STCP04-2	Real Time Data Link Management	Issue 007	25 April 2023
STCP04-3	Real Time Data Link Provision	Issue 008	25 April 2023
STCP04-4	Provision of Asset Operational Information	Issue 005	25 April 2023
STCP04-5	Operational Telephony	Issue 006	25 April 2023
STCP04-6	Offshore Datalink Functional Spec for Tele	Issue 004	25 April 2023
STCP06-1	Black Start	Issue 007	25 April 2023
STCP06-2	De-synchronised Island Management	Issue 006	25 April 2023
STCP06-3	System Incident Management	Issue 007	25 April 2023
STCP06-4	Contingency Arrangements	Issue 007	25 April 2023
STCP08-1	Protection Testing	Issue 006	25 April 2023
STCP08-2	Circuit Live Trip & DAR Tests	Issue 007	25 April 2023
STCP08-3	Operational Test and System Test	Issue 006	25 April 2023
STCP08-4	Users Tests	Issue 006	25 April 2023
STCP09-1	Safety and Co-ordination between parties	Issue 007	25 April 2023

STCP09-2	Public and Site Safety	Issue 007	25 April 2023
STCP10-1	Asset Nomenclature	Issue 006	25 April 2023
STCP11-1	Outage Planning	Issue 008	25 April 2023
STCP11-2	Outage Data Exchange	Issue 008	25 April 2023
STCP11-3	TO Outage Chang Costing	Issue 006	25 April 2023
STCP11-4	Enhanced Service Provision	Issue 005	25 April 2023
STCP12-1	Data Exchange Mechanism	Issue 006	25 April 2023
STCP13-1	TNUoS Cashflow Transfer – Invoicing Payment	Issue 012	25 April 2023
STCP13-2	SIF and LARF Methodology	Issue 003	25 April 2023
STCP14-1	Data Exchange for Annual Charge Setting	Issue 012	25 April 2023
STCP14-2	Data Requirements for Charging Consultations	Issue 005	25 April 2023
STCP14-3	Customer Charging Enquiries	Issue 005	25 April 2023
STCP16-1	Investment Planning	Issue 008	25 April 2023
STCP17-1	Feasibility Study	Issue 006	25 April 2023
STCP18-1	Connection and Mod Application	Issue 012	25 April 2023
STCP18-2	Use of System Application	Issue 008	25 April 2023
STCP18-3	Tec Changes	Issue 010	25 April 2023
STCP18-4	Requests for a Statement of Works	Issue 006	25 April 2023
STCP18-6	Variation to Agreements	Issue 007	25 April 2023
STCP19-2	Construction Process and Scheme Closure	Issue 007	25 April 2023
STCP19-3	Operational Notification & Compliance Testing	Issue 010	25 April 2023
STCP19-4	Commissioning and Decommissioning	Issue 009	25 April 2023
STCP19-5	Offshore Compliance Process Testing	Issue 006	25 April 2023
STCP19-6	Application Fee	Issue 009	25 April 2023
STCP20-1	Electricity Ten Year Statement	Issue 006	25 April 2023
STCP21-1	Network Options Assessment	Issue 005	25 April 2023
STCP21-2	Network Output Measures Data Exchange	Issue 002	25 April 2023
STCP22-1	Production of Models for GB System	Issue 005	25 April 2023
STCP23-1	Offshore Entry Process	Issue 003	25 April 2023
STCP24-1	Revenue Forecast Information Provision	Issue 006	25 April 2023
STCP25-1	Significant Code Review Process	Issue 003	25 April 2023
STCP25-2	Send Back Process	Issue 003	25 April 2023
STCP25-3	Fast Track Self-Governance Process	Issue 003	25 April 2023
STCP26-1	Active Network management	Issue 003	25 April 2023
STCP27-1	System Performance Monitoring	Issue 003	25 April 2023

SCHEDULE THREE

INFORMATION AND DATA EXCHANGE SPECIFICATION

This Schedule sets out the information and data permitted to be Disclosed by a Party to a Transmission Owner in accordance with Section F of the Code.

1. Information and Data Exchange During the Transition Period

During the Transition Period, a Party may Disclose to a Transmission Owner such information and data as shall:

- 1.1 be reasonably requested by a relevant Party or Parties for the purpose of Section I and approved by the Authority from time to time; or
- 1.2 otherwise be notified by the Authority from time to time.

2. Information and Data Exchange Other than During the Transition Period

2.1 General Principles

2.1.1 For the purposes of this Schedule Three:

- (a) "**BM Unit**" as defined in the Grid Code as at the Code Effective Date;
- (b) "**Boundary of Influence**" in relation to a Transmission System, means the area identified as the boundary of influence for such Transmission System in Schedule Four;
- (c) "**Demand**" as defined in the Grid Code as at the Code Effective Date;
- (d) "**De-synchronised Island(s)**" as defined in the Grid Code as at the Code Effective Date;
- (e) "**Export and Import Limits**" shall have the same meaning as the term "Export and Import Limits" in the Grid Code as at the Code Effective Date;
- (f) "**Generating Unit**" as defined in the Grid Code as at the Code Effective Date;
- (g) "**Ranking Order**" means The Company's forecast of available Generating Units, listed in order of likely operation, whose generated output would contribute to meeting forecast Demand;
- (h) "**Receiving Transmission Owner**" means a Transmission Owner to whom information is Disclosed;

- (i) **"Relevant Unit"** means any Generating Unit, Power Station, Plant or Apparatus forming part of a Power Station, Non-Embedded Customer or User System which is:
 - (a) Connected to, or is otherwise Connected within the Boundary of Influence of, a Receiving Transmission Owner's Transmission System; or
 - (b) directly connected to a User System which is Connected to, or is otherwise Connected within the Boundary of Influence of, such Transmission Owner's Transmission System.
- (j) **"FES Scenarios"** means the forecast future generation (listed in order of likely operation) and Demand backgrounds to be provided by The Company which are to be utilised for the purposes of the development of the Network Options Assessment.
- (k) **"Network Options Assessment"** means the process and the report produced by The Company in accordance with Standard Condition C27 (The Network Options Assessment process and reporting requirements).

2.1.2 A Party may Disclose any information or data to a Transmission Owner other than User Data or Transmission Information, which may only be Disclosed in accordance with this Schedule Three.

2.1.3 Where required to Disclose User Data or Transmission Information to a Transmission Owner, in accordance with a provision of this Code, a Party shall:

- (a) only Disclose User Data or Transmission Information which, in its reasonable opinion, is necessary for the Receiving Transmission Owner to comply with this Code or a TO Construction Agreement;
- (b) be entitled to Disclose Transmission Information derived from information already held by the Receiving Transmission Owner or derived from information which a Party is permitted to Disclose to such Transmission Owner; and
- (c) be entitled to Disclose correction(s) to any error(s) in User Data or Transmission Information previously Disclosed by it to the Receiving Transmission Owner.

2.1.4 For the avoidance of doubt:

- (a) nothing in this Schedule Three shall be taken to require a Party to Disclose User Data or Transmission Information to a Transmission Owner;
- (b) sub-paragraph 2.1.3(c) is limited to the correction of errors and shall not permit a Party to update User Data or Transmission Information held by

a Transmission Owner other than in accordance with the process or timeframe specified for such updates in this Code; and

- (c) Transmission Information shall not include information related to or forming part of any administrative process under this Code including, without limitation, invoices, credit notes, contact details of staff and office locations.

2.1.5 The Company may Disclose to a Transmission Owner any User Data or Transmission Information specified in Schedules Five, Six or Seven and forming part of a Construction Application or Schedules Eleven or Thirteen.

2.1.6 Without limitation to sub-paragraph 2.1.5, a Party may disclose to a Transmission Owner any Transmission Information or User Data necessary for the Receiving Transmission Owner and the Party Disclosing such Transmission Information or User Data to harmonise:

- (a) their TO Offers for a Construction Project
- (b) their preparation of Network Options for The Company
 - (i) as part of the annual Network Options Assessment
 - (ii) as part of the development of Strategic Wider Works submissions
 - (iii) as part of the development of small TO schemes
- (c) their respective design options following, or as part of, any feasibility studies being undertaken in respect of a proposed Construction Project.

2.2 General Transmission Information

2.2.1 A Party may Disclose the following Transmission Information to a Transmission Owner:

- (a) specifications of any current or future IT or communications system(s) of the Disclosing Party and the operation and maintenance of such system(s);
- (b) information incidental to the development of the form of any Services Capability Specification;
- (c) information incidental to Party Entry Processes or Decommissioning Actions;
- (d) any information in, or related to the development of, a Local Joint Restoration Plan or De-synchronised Island(s) procedure for the Receiving Transmission Owner's Transmission System;

- (e) information forming part of or related to the conduct of a Joint Investigation;
- (f) numbering or nomenclature information;
- (g) information for the purpose of safety co-ordination including, without limitation, Safety Rules, Site Responsibility Schedules and Local Safety Instructions;
- (h) information related to the development or conduct of tests, but not including the results of such tests (except and to the extent that such results are otherwise permitted to be Disclosed under this Schedule Three);
- (i) information related to the subject matter of any Dispute referred to arbitration under Section D, paragraph 5 or an Independent Engineer under a Construction Agreement;
- (j) information in relation to any direction or notice issued or proposed by The Company in respect of Nuclear Installations under Section G, paragraph 3;
- (k) technical or other information under Section G, paragraph 6, following the disposal or the whole or any part of the Disclosing Party's business or undertaking;
- (l) information forming part of any notice of Force Majeure;
- (m) technical information for the modelling of control systems included in an Offshore Transmission System to provide dynamic control of reactive capability and voltage in accordance with Section K of this STC; and
- (n) technical information for the modelling of control systems included in an embedded HVDC scheme or 'bootstrap'.

2.2.2 Where information is being Disclosed under Party Entry Processes, a Party may Disclose to a Transmission Owner pursuant to the Party Entry Processes any information which would otherwise be permitted to be Disclosed to such Transmission Owner if the Party Entry Processes were completed and all relevant parts of the Code applied to the entering Party who is the subject of the Part Entry Processes at the time of the Disclosure.

2.3 **Transmission Information required for the configuration and operation of the National Electricity Transmission System**

2.3.1 The Company may Disclose the following Transmission Information to a Transmission Owner in relation to such Receiving Transmission Owner's Transmission System or any neighbouring circuits of a neighbouring

Transmission System which are directly connected to the Receiving Transmission Owner's Transmission System:

- (a) information related to the actual or designed physical properties, including, but not limited to:
 - (i) the voltage of any part;
 - (ii) the electrical current flowing in or over any part;
 - (iii) the temperature of any part;
 - (iv) the pressure of any fluid part;
 - (v) the electromagnetic properties of any part; and
 - (vi) the technical specifications, settings or operation of any Protection Systems associated with any part;
- (b) any estimation made by The Company of the physical properties referred to in sub-paragraph (a);
- (c) details of and reasons for Operational Capability Limits or other limits or conditions notified pursuant to Section C, Part One, paragraph 4.14 being exceeded or breached on the Receiving Transmission Owner's Transmission System;
- (d) details of any Event, Significant Incident or other circumstance which will or is likely to materially affect the provision of Transmission Services by the Receiving Transmission Owner including, but not limited to, the information set out in Section C, Part Three, sub-paragraph 4.1.4; and
- (e) information in respect of a Disaster Recovery Plan or System Incident Centre.

2.3.2 A Party may Disclose to a Transmission Owner Transmission Information including, but not limited to, the matters set out in sub-paragraphs 2.4.7(a)-(g), related to the past or present physical properties, including both actual and designed physical properties, of any circuits of the Disclosing Party's Transmission System which are directly connected to the Receiving Transmission Owner's Transmission System.

2.3.3 Any Party may Disclose to a Transmission Owner, Transmission Information related to the current or future configuration of:

- (a) the Receiving Transmission Owner's Transmission System; and
- (b) any circuits of a neighbouring Transmission System which are directly connected to the Receiving Transmission Owner's Transmission System.

2.4 User Data

2.4.1 A Party may Disclose the following User Data to a Transmission Owner:

- (a) numbering or nomenclature information;
- (b) information which has been made available in accordance with the CUSC to all CUSC Parties (including where such information is made available pursuant to the Grid Code);
- (c) information which has been made available in accordance with the BSC to all BSC Parties;
- (d) information for the purpose of safety co-ordination including, without limitation, Safety Rules, Site Responsibility Schedules and Local Safety Instructions;
- (e) information specified in the Grid Code; and
- (f) the Export and Import Limits of a Relevant Unit as part of the implementation of a Local Joint Restoration Plan or De-synchronised Island(s) procedure.

2.5 Investment Planning Data

2.5.1 A Party may Disclose to a Transmission Owner,

- (a) where the Disclosing Party is The Company:
 - (i) NGET's forecast(s) of the Ranking Order for the National Electricity Transmission System, specifying:
 - a. relevant individual Generation Units connected to the Receiving Party's Transmission System or connected within the Boundary of Influence of such Transmission System; and
 - b. relevant aggregations of Generation Units connected outside of the Boundary of Influence of such Transmission System,at any time or times during the current or following nine Financial Years or more subject to agreement by the Joint Planning Committee or a sub-group thereof;
 - (ii) lists of all Generation Units which The Company forecasts will be synchronised to meet specified levels of Demand on the National Electricity Transmission System in the current and following nine Financial Years or more subject to agreement as above, including, but not limited to:
 - a. the forecast minimum Demand;

- b. 60% of the forecast peak Demand;
 - c. the forecast peak Demand;
 - d. and at other levels of demand and generation plant mix as agreed in advance by the parties where deemed necessary:
- (iii) the high level results of any economic studies undertaken for the purpose of assessing options for investment planning or Construction Projects, in each case involving the Receiving Transmission Owner, but not including the detailed content or analysis in such studies; and
- (b) any changes which the Disclosing Party is planning to undertake to its Transmission System in the current or following nine Financial Years or more as agreed above, and which will materially affect the planning or development of the Receiving Transmission Owner's Transmission System as are located within the Boundary of Influence of the Disclosing Party's Transmission System.

2.5.2 A Party may Disclose to a Transmission Owner any part(s) of:

- (a) the Final Generation Outage Programme for Years 3 to 5 agreed pursuant to OC2.4.1.2.1(j) of the Grid Code;
- (b) any updated proposed Generation Outage Programme submitted to The Company under OC2.4.1.2.2(a) of the Grid Code; or
- (c) the revised Final Generation Outage Programme for Year 1 and Year 2 agreed pursuant to OC2.4.1.2.2(i) of the Grid Code,

which relates to outages or proposed outages of Relevant Units.

2.5.3 A Party may Disclose to a Transmission Owner information related to the past or present physical properties, including both actual and designed physical properties, of Plant and Apparatus forming part of any Relevant Units including, but not limited to:

- (a) the voltage of any part of such Plant and Apparatus;
- (b) the electrical current flowing in or over such Plant and Apparatus;
- (c) the configuration of any part of such Plant and Apparatus;
- (d) the temperature of any part of such Plant and Apparatus;
- (e) the pressure of any fluid forming part of such Plant and Apparatus
- (f) the electromagnetic properties of such Plant and Apparatus; and

- (g) the technical specifications, settings or operation of any Protection Systems forming part of such Plant and Apparatus.

2.6 Construction Projects

2.6.1 The Company may Disclose the following Transmission Information and User Data to a Transmission Owner which is party to a TO Construction Agreement provided that Disclosure is only made in connection with such TO Construction Agreement:

- (a) information about any Consents which materially affect the Works being undertaken by the Receiving Transmission Owner as part of the relevant Construction Project;
- (b) information related to commissioning or on-load testing;
- (c) information incidental to the disconnection of Users or removal of User Equipment or Plant and Apparatus;
- (d) information in relation to the sub-contractors of the relevant User;
- (e) the grounds for any discontinuation, postponement or delay of Works or other activities under paragraph 2.10 of the Construction Agreement;
- (f) regulations in relation to site access made by a relevant site owner or occupier;
- (g) information forming part of, or incidental to the development of, the Construction Programme or Commissioning Programme, including information in relation to User Works where this is necessary for the development of such Construction Programme or Commissioning Programme;
- (h) reasons for any delay in the performance of a Construction Programme or Commissioning Programme;
- (i) any statement of Liquidated Damages; and
- (j) information related to the selection of an Independent Engineer.

2.7 Network Options Assessment Data

2.7.1 A Party may Disclose to a Transmission Owner:

- (a) where the Disclosing Party is The Company the FES Scenarios; and
- (b) the results of its assessments undertaken in connection with the development of the Future Energy Scenarios which will affect the assessments undertaken by another Transmission Owner in respect of its Transmission System;

- (c) where the Disclosing Party is The Company, the Network Options of one Transmission Owner to another Transmission Owner within a relevant Boundary of Influence, in accordance with a procedure agreed by the Joint Planning Committee or sub-group thereof.

2.7.2 A Transmission Owner may disclose to The Company :

- (a) a cost breakdown of the Transmission Connection Assets, the GAV and the risk margin
- (b) where no cost data is provided by the Transmission Owner to the agreed delivery timetable for NOA, The Company shall use substituted data. The Company shall indicate within the published report that Transmission Owner data was not received, that substituted data were used and how these data were derived. In such circumstances The Company shall inform the Transmission Owner of the data that have been substituted and how these data were derived.

SCHEDULE FOUR

Criteria for Assessing Those Transmission Systems Affected by a Construction Project

SHETL Boundary of Influence to SPTL

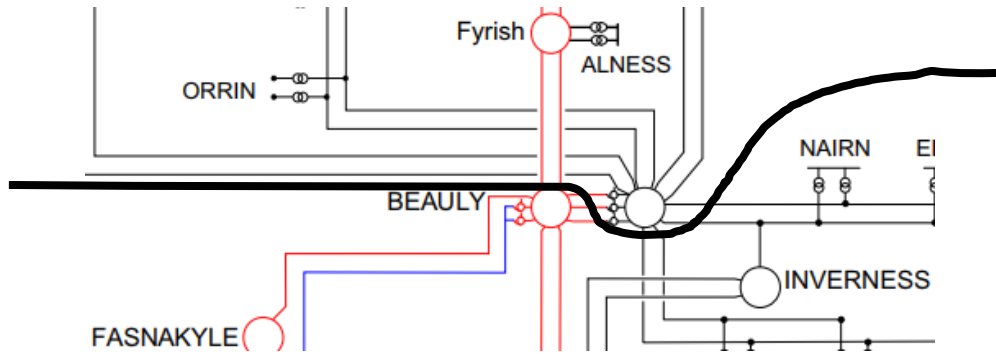

SPTL Boundary of Influence to SHETL

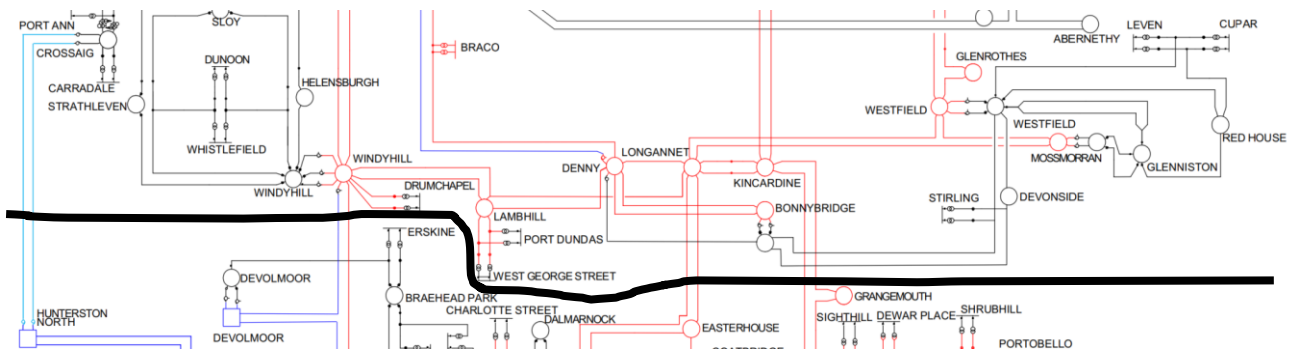

SPTL Boundary of Influence to NGET

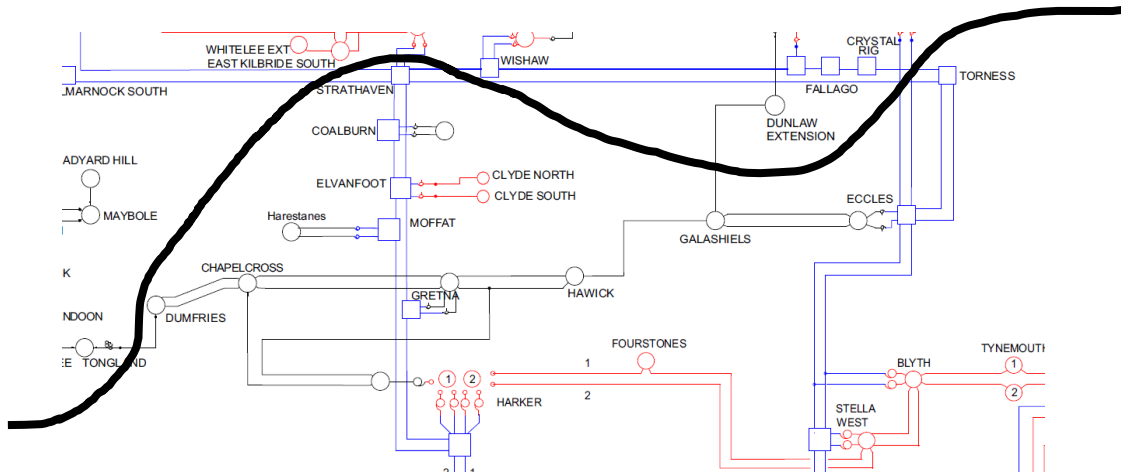

NGET Boundary of Influence to SPTL

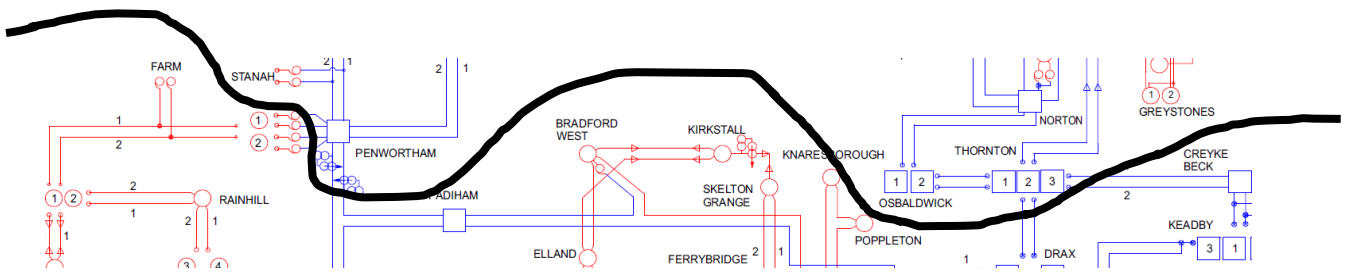

SCHEDULE FIVE

THE COMPANY CONNECTION APPLICATIONS

1. **Requirements for The Company Connection Application submitted by The Company to a Transmission Owner pursuant to Section D, Part Two, sub-paragraph 2.2.1:**

1.1 The Company Connection Application submitted by The Company to a Transmission Owner pursuant to Section D, Part Two, sub-paragraph 2.2.1 shall contain the following information:

Proposed New Connection Site

- 1.1.1 The User Application Date.
- 1.1.2 Identification of the intended location of the New Connection Site (preferably by reference to an extract from an ordinance survey map), specifying the name of the New Connection Site together with details of access to the New Connection Site, including from the nearest main road.
- 1.1.3 A plan or plans of the proposed New Connection Site indicating (as far as The Company is able) the position of all buildings, structures, plant and apparatus and of all services located on the New Connection Site.
- 1.1.4 Details of whether the New Connection Site is to be freehold, heritable or leasehold (to include details of any servitudes or wayleaves or other property rights) insofar as The Company is aware.
- 1.1.5 The occupier of the New Connection Site so far as The Company is aware.
- 1.1.6 Where a sub-station may be needed, an indication by reference to the plan referred to in sub-paragraph 1.1.3, any location for it suggested by the relevant User, giving dimensions of the area.
- 1.1.7 Where the User is prepared to make available to the Transmission Owner the land necessary for the sub-station referred to in sub-paragraph 1.1.6, brief proposals for the Transmission Owner's interest in it including (if relevant) such interest and the consideration to be paid for it.
- 1.1.8 Whether space is available on the New Connection Site for working storage and accommodation areas for the contractors of the Transmission Owner and, if so,

an indication by reference to the plan referred to in sub-paragraph 1.1.3 above the location of such areas, giving approximate dimensions of the same.

- 1.1.9 Details (including copies of any surveys or reports) of the physical nature of land in which the User has an interest (whether freehold, heritable or leasehold or by way of a servitude or wayleave or other property right) at the proposed New Connection Site including the nature of the ground and the sub-soil including the results of any tests undertaken by the User in connection with the New Connection.
- 1.1.10 Details and copies of all existing relevant planning and other consents (statutory and otherwise) relating to the New Connection Site and the User Equipment and/or details of any pending applications for the same.
- 1.1.11 Whether access to or use of the New Connection Site for the purposes of installing, maintaining and operating equipment is subject to any existing restrictions and, if so, details of such restrictions.
- 1.1.12 To the extent that The Company is aware of them, identification by reference to a plan (if possible) the owners and (if different) occupiers of the land adjoining the New Connection Site and brief details of the owner's and occupier's respective interests in such land.

Technical Information

- 1.1.13 Standard Planning Data.
- 1.1.14 A copy of the User's Safety Rules.
- 1.1.15 The User's intended Connection Entry Capacity.
- 1.1.16 The User's intended Transmission Entry Capacity.

Programme

- 1.1.17 The User's suggested construction programme in bar chart form for the construction work necessary to install the User Equipment.
- 1.1.18 The date on which NGET wishes the New Connection Site to be made Operational.
- 1.1.19 The details of any charging options exercised by the User to the extent necessary for the Transmission Owner to calculate TO Charges in respect of those options in accordance with its charging methodology.

Connect and Manage Arrangements

1.1.20 Confirmation that the application is/is not made on the basis of the Connect and Manage Arrangements.

1.1.21 If to be on the Connect and Manage arrangements confirmation whether the User has requested that the Enabling Works are to be greater in scope than the MITS Connection Works.

1.1.22 If the Enabling Works are to be greater in scope than the MITS Connection Works, details (to the extent available to The Company) of the concerns, reasons or technical requirements that this is seeking to address.

User Commitment Methodology

1.1.23 Confirmation that the above methodology is to be applied such that the Attributable Works provisions are/are not required.

2. Requirements for The Company Connection Application submitted by The Company to a Transmission Owner pursuant to Section D, Part Two, sub-paragraph 2.2.2:

2.1 The Company Connection Application submitted by The Company to a Transmission Owner pursuant to Section D, Part Two, sub-paragraph 2.2.2 shall contain the following information:

2.1.1 The User Application Date.

2.1.2 Standard Planning Data.

2.1.3 The User's intended Transmission Entry Capacity.

2.1.4 The date on which The Company wishes the New Connection Site to be made Operational.

Connect and Manage Arrangements

2.1.5 Confirmation that the application is/is not made on the basis of the Connect and Manage Arrangements.

2.1.6 If to be on the Connect and Manage arrangements confirmation whether the User has requested that the Enabling Works are to be greater in scope than the MITS Connection Works.

- 2.1.7 If the Enabling Works are to be greater in scope than the MITS Connection Works, details (to the extent available to The Company) of the concerns, reasons or technical requirements that this is seeking to address.

User Commitment Methodology

- 2.1.8 Confirmation that the above methodology is to be applied such that the Attributable Works provisions are/are not required.

3. **Requirements for The Company Connection Application submitted by The Company to a Transmission Owner pursuant to Section D, Part Two, sub-paragraph 2.2.3:**

- 3.1 The Company Connection Application submitted by The Company to a Transmission Owner pursuant to Section D, Part Two, sub-paragraph 2.2.3 shall contain the following information:

Proposed New Transmission Interface Site

- 3.1.1 The User Application Date.
- 3.1.2 Identification of the intended location of the New Transmission Interface Site (preferably by reference to an extract from an ordinance survey map), specifying the name of the New Transmission Interface Site together with details of access to the New Transmission Interface Site, including from the nearest main road.
- 3.1.3 A plan or plans of the proposed New Transmission Interface Site indicated (as far as The Company is able) the position of all buildings, structures, plant and apparatus and of all services located on the New Transmission Interface Site.
- 3.1.4 Where a sub-station may be needed, an indication by reference to the plan referred to in sub-paragraph 3.1.3, any location for it suggested by The Company.
- 3.1.5 Confirmation, if this is the case, that the Offshore Transmission System is to be delivered through OTSDUW build.

Technical Information

- 3.1.6 Standard Planning Data.

3.1.7 The required Interface Point Capacity.

Programme

3.1.8 The date on which The Company wishes the New Transmission Interface Site to be made Operational.

Connect and Manage Arrangements

3.1.9 Confirmation that the application is/is not made on the basis of the Connect and Manage Arrangements.

3.1.10 If to be on the Connect and Manage arrangements confirmation whether the User has requested that the Enabling Works are to be greater in scope than the MITS Connection Works.

3.1.11 If the Enabling Works are to be greater in scope than the MITS Connection Works, details (to the extent available to The Company) of the concerns, reasons or technical requirements that this is seeking to address.

User Commitment Methodology

3.1.12 Confirmation that the above methodology is to be applied such that the Attributable Works provisions are/are not required.

4. Requirements for The Company Connection Application submitted by The Company to a Transmission Owner pursuant to Section D, Part Two, sub-paragraph 2.2.4 (including OFTO Build but excluding OTSDUW Build Applications):

4.1 The Company Connection Application submitted by The Company to a Transmission Owner pursuant to Section D, Part Two, sub-paragraph 2.2.4 shall contain the following information:

Proposed New Connection Site

4.1.1 The User Application Date.

4.1.2 Identification of the intended location of the New Connection Site (preferably by reference to an extract from an ordinance survey map or an admiralty chart), specifying the name of the New Connection Site together with details of access to the New Connection Site.

- 4.1.3 A plan or plans of the proposed New Connection Site indicated (as far as The Company is able) the position of all buildings, structures, plant and apparatus and of all services located on the New Connection Site.
- 4.1.4 Details of whether the New Connection Site is subject to a Crown Estate lease insofar as The Company is aware.
- 4.1.5 The occupier of the New Connection Site so far as The Company is aware.
- 4.1.6 Where a sub-station may be needed, an indication by reference to the plan referred to in sub-paragraph 4.1.3, any location for it suggested by the relevant User, giving dimensions of the area.
- 4.1.7 Where the User is prepared to make available to the Transmission Owner the Offshore Platform for the sub-station referred to in sub-paragraph 4.1.6, brief proposals for the Offshore Transmission Owner's interest in it including (if relevant) such interest and the consideration to be paid for it.
- 4.1.8 Whether space is available on the New Connection Site for working storage and accommodation areas for the contractors of the Offshore Transmission Owner and, if so, an indication by reference to the plan referred to in sub-paragraph 4.1.3 above the location of such areas, giving approximate dimensions of the same.
- 4.1.9 Details (including copies of any surveys or reports) of the physical nature of land in which the User has an interest (whether freehold, heritable or leasehold or by way of a servitude or wayleave or other property right) at the proposed New Connection Site including the nature of the ground and the sub-soil including the results of any tests undertaken by the User in connection with the New Connection.
- 4.1.10 Details and copies of all existing relevant planning and other consents (statutory and otherwise) relating to the New Connection Site and the User Equipment and/or details of any pending applications for the same.
- 4.1.11 Whether access to or use of the New Connection Site for the purposes of installing, maintaining and operating equipment is subject to any existing restrictions and, if so, details of such restrictions.
- 4.1.12 To the extent that The Company is aware of them, identification by reference to a plan (if possible) the owners and (if different) occupiers of the land adjoining the New Connection Site and brief details of the owner's and occupier's respective interests in such land.

Proposed New Transmission Interface Site or New Embedded Transmission Interface Site

- 4.1.13 Identification of the intended location of the New Transmission Interface Site or New Embedded Transmission Interface Site (preferably by reference to an extract from an ordinance survey map), specifying the name of the New Transmission Interface Site or New Embedded Transmission Interface Site together with details of access to the New Transmission Interface Site or New Embedded Transmission Interface Site, including from the nearest main road.
- 4.1.14 A plan or plans of the proposed New Transmission Interface Site or New Embedded Transmission Interface Site indicated (as far as The Company is able) the position of all buildings, structures, plant and apparatus and of all services located on the New Transmission Interface Site or New Embedded Transmission Interface Site.
- 4.1.15 A description of any technical design or operational criteria which the Onshore Transmission Owner reasonably considers Offshore Transmission Owner Equipment would be required to meet in order for such Onshore Transmission Owner to comply with Standard Condition D3 of its Transmission Licence as applicable.

Technical Information

- 4.1.16 Standard Planning Data.
- 4.1.17 A copy of the User's Safety Rules.
- 4.1.18 The User's intended Connection Entry Capacity.
- 4.1.19 The User's intended Transmission Entry Capacity.
- 4.1.20 The User's intended Reactive Power Capability
- 4.1.21 Additional information required for Voltage Waveform Quality Assessment at the Interface Point.

Programme

- 4.1.22 The User's suggested construction programme in bar chart form for the construction work necessary to install the User Equipment.
- 4.1.23 The date on which The Company wishes the New Connection Site to be made Operational.

- 4.1.24 The details of any charging options exercised by the User to the extent necessary for the Transmission Owner to calculate TO Charges in respect of those options in accordance with its charging methodology.
- 4.1.25 The suggested date for completion of the construction work necessary to install Onshore Transmission Owner or Distribution Network Operator equipment at the New Transmission Interface Site or New Embedded Transmission Interface Site;

OTSDUW

- 4.1.26 Confirmation of the scope and extent of any OTSDUW that has been, or is to be, undertaken by the User.
 - 4.1.27 The User's suggested programme in bar chart form for any OTSDUW that has not yet been completed.
 - 4.1.28 Where the OTSDUW includes obtaining consents in respect of the Offshore Construction Works (or any part of them), copies of the consents so obtained.
 - 4.1.29 Where the OTSDUW includes design of the Offshore Construction Works (or any part of them), details of the User's design (including any Detailed Design Data).
 - 4.1.30 Information about the OTSDUW provided by the User to The Company under the Other Code.
- 4A. Requirements for an OTSDUW Build Application submitted by The Company to a Transmission Owner pursuant to Section D, Part Two, sub-paragraph 2.2.4:
- 4A.1 An OTSDUW Build Application submitted by The Company to a Transmission Owner pursuant to Section D, Part Two, sub-paragraph 2.2.4 shall contain the following information (unless and to the extent agreed otherwise with the nominated Offshore Transmission Owner who may already be in possession of the same as a result of the tender process following which it has been appointed):

New Connection Site

- 4A.1.1 Identification of the location of the New Connection Site (preferably by reference to an extract from an ordinance survey map or an admiralty chart), specifying the name of the New Connection Site together with details of access to the New Connection Site.
- 4A.1.2 A plan or plans of the New Connection Site indicating (as far as The Company is able) the position of all buildings, structures, plant and apparatus and of all services located thereon.
- 4A.1.3 Details of whether the New Connection Site is subject to a Crown Estate lease insofar as The Company is aware.

- 4A.1.4 Confirmation of the User's identity.
- 4A.1.5 The location of any sub-station, by reference to the plan referred to in subparagraph 4A.1.2, giving dimensions of the area.
- 4A.1.6 Details (including copies of any surveys or reports) of the physical nature of land in which the User has an interest (whether freehold, heritable or leasehold or by way of a servitude or wayleave or other property right) at the New Connection Site including the nature of the ground and the sub-soil including the results of any tests undertaken by the User in connection with the New Connection.
- 4A.1.7 Whether access to or use of the New Connection Site for the purposes of installing, maintaining and operating equipment is subject to any existing restrictions and, if so, details of such restrictions.
- 4A.1.8 To the extent that The Company is aware of them, identification by reference to a plan (if possible) the owners and (if different) occupiers of the land adjoining the New Connection Site and brief details of the owner's and occupier's respective interests in such land.

Consents

- 4A.1.9 Details and copies of all existing relevant planning and other consents (statutory and otherwise) relating to the OTSUA and the User Equipment and/or details of any pending applications for the same.

Proposed New Transmission Interface Site or New Embedded Transmission Interface Site

- 4A.1.10 Identification of the location of the New Transmission Interface Site or New Embedded Transmission Interface Site (preferably by reference to an extract from an ordinance survey map), specifying the name of the New Transmission Interface Site or New Embedded Transmission Interface Site together with details of access to the New Transmission Interface Site or New Embedded Transmission Interface Site, including from the nearest main road.
- 4A.1.11 A plan or plans of the New Transmission Interface Site or New Embedded Transmission Interface Site indicating (as far as The Company is able) the position of all buildings, structures, plant and apparatus and of all services located on the New Transmission Interface Site or New Embedded Transmission Interface Site.

Phasing

- 4A.1.12 Confirmation of whether the OTSUA are to be transferred in phases.

4A.1.13 If so, identification of which OTSUA are to be transferred in each phase, and of the User's proposed date for each such transfer.

Technical Information

4A.1.14 Standard Planning Data (including Standard Planning Data relating to the OTSUA).

4A.1.15 Detailed Planning Data relating to the OTSUA.

4A.1.16 A copy of the User's Safety Rules.

4A.1.17 The User's Connection Entry Capacity.

4A.1.18 The User's Transmission Entry Capacity.

4A.1.19 The User's Reactive Power Capability.

4A.1.20 Copies of the then current forms of the Connection Site Specification, Transmission Interface Site Specification and the Services Capability Specification, each as provided by the User to The Company under the Other Code.

5. **Requirements for The Company Connection Application submitted by The Company to a Transmission Owner pursuant to Section D, Part Two, sub-paragraph 2.2.5:**

5.1 The Company Connection Application submitted by The Company to a Transmission Owner pursuant to Section D, Part Two, sub-paragraph 2.2.5 shall contain the following information:

5.1.1 The User Application Date.

5.1.2 The date on which The Company wishes the New Connection Site to be made Operational.

Connect and Manage Arrangements

5.1.3 Confirmation that the application is/is not made on the basis of the Connect and Manage Arrangements.

5.1.4 If to be on the Connect and Manage arrangements confirmation whether the User has requested that the Enabling Works are to be greater in scope than the MITS Connection Works.

- 5.1.5 If the Enabling Works are to be greater in scope than the MITS Connection Works, details (to the extent available to The Company) of the concerns, reasons or technical requirements that this is seeking to address.

User Commitment Methodology

- 5.1.6 Confirmation that the above methodology is to be applied such that the Attributable Works provisions are/are not required.

SCHEDULE SIX

THE COMPANY MODIFICATION APPLICATIONS

1. **Requirements for The Company Modification Application submitted by The Company to a Transmission Owner pursuant to Section D, Part Two, sub-paragraph 2.2.1:**

1.1 The Company Modification Application submitted by The Company to a Transmission Owner pursuant to Section D, Part Two, sub-paragraph 2.2.1 shall contain the following information:

The Connection Site to be Modified

1.1.1 The User Application Date.

1.1.2 Identify by name the Connection Site at which the Modification is to be undertaken.

1.1.3 Details of the rights in any additional land which the User is proposing to acquire at the Connection Site (to include freehold, heritable or leasehold interests or by way of a servitude or wayleave or other property right so as to undertake the Modification).

1.1.4 Whether space is available on the Connection Site for working storage and accommodation areas for the contractors of the Transmission Owner and, if so, an indication by reference to a plan the location of such areas, giving approximate dimensions of the same.

1.1.5 Details (including copies of any surveys or reports) of the physical nature of any additional land referred to in sub-paragraph 1.1.3 above including the nature of the ground and the sub-soil including the results of any tests undertaken by the User in connection with the New Connection.

1.1.6 Details and copies of all existing relevant planning and other consents (statutory and otherwise) relating to the Connection Site or the Modification and/or details of any pending applications for the same.

1.1.7 An indication of what, if any, of the necessary construction works necessary for the Modification The Company would like the Transmission Owner to conduct on its behalf (or on behalf of the User).

Technical Information

1.1.8 Full details of the proposed Modification together with relevant Standard Planning Data to the extent that the data will change, as a result of the proposed Modification, from data previously made available to the Transmission Owner.

Programme

- 1.1.9 The User's suggested construction programme in bar chart form for the construction work necessary to install the Modification.
- 1.1.10 The details of any charging options exercised by the User to the extent necessary for the Transmission Owner to calculate TO Charges in respect of those options in accordance with its charging methodology.
- 1.1.11 The date on which The Company wishes the Modification to be made Operational.

Connect and Manage Arrangements

- 1.1.12 Confirmation that the application is/is not made on the basis of the Connect and Manage Arrangements.
- 1.1.13 If to be on the Connect and Manage arrangements confirmation whether the User has requested that the Enabling Works are to be greater in scope than the MITS Connection Works.
- 1.1.14 If the Enabling Works are to be greater in scope than the MITS Connection Works, details (to the extent available to The Company) of the concerns, reasons or technical requirements that this is seeking to address.

2. Requirements for The Company Modification Application submitted by The Company to a Transmission Owner pursuant to Section D, Part Two, sub-paragraph 2.2.2:

- 2.1 The Company Modification Application submitted by The Company to a Transmission Owner pursuant to Section D, Part Two, sub-paragraph 2.2.2 shall contain the following information:
 - 2.1.1 The User Application Date.
 - 2.1.2 Standard Planning Data.
 - 2.1.3 The User's intended Transmission Entry Capacity, or, in respect of a The Company Modification Application following an earlier The Company Request for a Statement of Works, the capacity of the Power Station connecting to the User's Distribution System.
 - 2.1.4 The date on which The Company wishes the Modification to be made Operational.

Connect and Manage Arrangements

2.1.5 Confirmation that the application is/is not made on the basis of the Connect and Manage Arrangements.

2.1.6 If to be on the Connect and Manage arrangements confirmation whether the User has requested that the Enabling Works are to be greater in scope than the MITS Connection Works.

2.1.7 If the Enabling Works are to be greater in scope than the MITS Connection Works, details (to the extent available to The Company) of the concerns, reasons or technical requirements that this is seeking to address.

3. Requirements for The Company Modification Application submitted by The Company to a Transmission Owner pursuant to Section D, Part Two, sub-paragraph 2.2.3:

3.1 The Company Modification Application submitted by The Company to a Transmission Owner pursuant to Section D, Part Two, sub-paragraph 2.2.3 shall contain the following information:

The Transmission Interface Site to be Modified

3.1.1 The User Application Date.

3.1.2 Identify by name the Transmission Interface Site at which the Modification is to be undertaken.

3.1.3 Details of the rights in any additional land which the Offshore Transmission Owner is proposing to acquire at the Transmission Interface Site (to include freehold, heritable or leasehold interests or by way of a servitude or wayleave or other property right so as to undertake the Modification).

3.1.4 Whether space is available on the Transmission Interface Site for working storage and accommodation areas for the contractors of the Transmission Owner and, if so, an indication by reference to a plan the location of such areas, giving approximate dimensions of the same.

3.1.5 Details (including copies of any surveys or reports) of the physical nature of any additional land referred to in sub-paragraph 1.1.3 above including the nature of the ground and the sub-soil including the results of any tests undertaken by the Offshore Transmission Owner in connection with the Transmission Interface Site.

3.1.6 Details and copies of all existing relevant planning and other consents (statutory and otherwise) relating to the Transmission Interface Site or the Modification and/or details of any pending applications for the same.

3.1.7 An indication of what, if any, of the necessary construction works necessary for the Modification The Company would like the Transmission Owner to conduct on its behalf (or on behalf of the Offshore Transmission Owner).

Technical Information

- 3.1.8 Full details of the proposed Modification together with relevant Standard Planning Data to the extent that the data will change, as a result of the proposed Modification, from data previously made available to the Transmission Owner.

Programme

- 3.1.9 The Offshore Transmission Owner's suggested construction programme in bar chart form for the construction work necessary to install the Modification.
- 3.1.10 The details of any charging options exercised by the User to the extent necessary for the Transmission Owner to calculate TO Charges in respect of those options in accordance with its charging methodology.
- 3.1.11 The date on which The Company wishes the Modification to be made Operational.

Connect and Manage Arrangements

- 3.1.12 Confirmation that the application is/is not made on the basis of the Connect and Manage Arrangements.
- 3.1.13 If to be on the Connect and Manage arrangements confirmation whether the User has requested that the Enabling Works are to be greater in scope than the MITS Connection Works.
- 3.1.14 If the Enabling Works are to be greater in scope than the MITS Connection Works, details (to the extent available to The Company) of the concerns, reasons or technical requirements that this is seeking to address.

4. Requirements for The Company Modification Application submitted by The Company to a Transmission Owner pursuant to Section D, Part Two, sub-paragraph 2.2.4:

- 4.1 The Company Modification Application submitted by The Company to a Transmission Owner pursuant to Section D, Part Two, sub-paragraph 2.2.4 shall contain the following information:

The Connection Site to be Modified

- 4.1.1 The User Application Date.
- 4.1.2 Identify by name the Connection Site at which the Modification is to be undertaken.
- 4.1.3 Details of the rights in any additional land which the User is proposing to acquire at the Connection Site (to include freehold, heritable or leasehold interests or by way of a servitude or wayleave or other property right so as to undertake the Modification).

- 4.1.4 Whether space is available on the Connection Site for working storage and accommodation areas for the contractors of the Transmission Owner and, if so, an indication by reference to a plan the location of such areas, giving approximate dimensions of the same.
- 4.1.5 Details (including copies of any surveys or reports) of the physical nature of any additional land referred to in sub-paragraph 4.1.3 above including the nature of the ground and the sub-soil including the results of any tests undertaken by the User in connection with the New Connection.
- 4.1.6 Details and copies of all existing relevant planning and other consents (statutory and otherwise) relating to the Connection Site or the Modification and/or details of any pending applications for the same.
- 4.1.7 An indication of what, if any, of the necessary construction works necessary for the Modification The Company would like the Transmission Owner to conduct on its behalf (or on behalf of the User).

The Transmission Interface Site or Embedded Transmission Interface Site to be Modified

- 4.1.8 Identification of the intended location of the New Transmission Interface Site or New Embedded Transmission Interface Site (preferably by reference to an extract from an ordinance survey map), specifying the name of the New Transmission Interface Site or New Embedded Transmission Interface Site together with details of access to the New Transmission Interface Site or New Embedded Transmission Interface Site, including from the nearest main road.
- 4.1.9 A plan or plans of the proposed New Transmission Interface Site or New Embedded Transmission Interface Site indicated (as far as The Company is able) the position of all buildings, structures, plant and apparatus and of all services located on the New Transmission Interface Site or New Embedded Transmission Interface Site.
- 4.1.10 A description of any technical design or operational criteria which the Onshore Transmission Owner reasonably considers Offshore Transmission Owner Equipment would be required to meet in order for such Onshore Transmission Owner to comply with Standard Condition D3 of its Transmission Licence as applicable.

Technical Information

- 4.1.11 Full details of the proposed Modification together with relevant Standard Planning Data to the extent that the data will change, as a result of the proposed Modification, from data previously made available to the Transmission Owner.

Programme

4.1.12 The User's suggested construction programme in bar chart form for the construction work necessary to install the Modification.

4.1.13 The details of any charging options exercised by the User to the extent necessary for the Transmission Owner to calculate TO Charges in respect of those options in accordance with its charging methodology.

4.1.14 The date on which The Company wishes the Modification to be made Operational.

5. **Requirements for The Company Modification Application submitted by The Company to a Transmission Owner pursuant to Section D, Part Two, sub-paragraph 2.2.5:**

5.1 The Company Modification Application submitted by The Company to a Transmission Owner pursuant to Section D, Part Two, sub-paragraph 2.2.5 shall contain the following information:

5.1.1 The User Application Date.

5.1.2 The date on which The Company wishes the Modification to be made Operational.

Connect and Manage Arrangements

5.1.3 Confirmation that the application is/is not made on the basis of the Connect and Manage Arrangements.

5.1.4 If to be on the Connect and Manage arrangements confirmation whether the User has requested that the Enabling Works are to be greater in scope than the MITS Connection Works.

5.1.5 If the Enabling Works are to be greater in scope than the MITS Connection Works, details (to the extent available to The Company) of the concerns, reasons or technical requirements that this is seeking to address.

SCHEDULE SEVEN

SYSTEM CONSTRUCTION APPLICATIONS

1. **Requirements for a System Construction Application submitted by The Company to a Transmission Owner pursuant to Section D, Part Two, sub-paragraph 2.2.2:**

1.1 A System Construction Application submitted by The Company to a Transmission Owner pursuant to Section D, Part Two, sub-paragraph 2.2.2 shall contain the following information:

1.1.1 The User Application Date.

1.1.2 Identify the location or intended location of any User Plant and Apparatus in relation to which the User Application relates.

1.1.3 Standard Planning Data.

1.1.4 The User's intended Transmission Entry Capacity.

1.1.5 The date on which The Company wishes the System Construction to be made Operational.

1.1.6 The details of any charging options exercised by the User to the extent necessary for the Transmission Owner to calculate TO Charges in respect of those options in accordance with its charging methodology.

Connect and Manage Arrangements

1.1.7 Confirmation whether the user has requested that the Enabling Works are to be greater in scope than the MITS Connection Works.

1.1.8 If the Enabling Works are to be greater in scope than the MITS Connection Works, details (to the extent available to The Company) of the concerns, reasons or technical requirements that this is seeking to address.

User Commitment Methodology

1.1.9 Confirmation that the above methodology is to be applied such that the Attributable Works provisions are/are not required.

2. **Requirements for a System Construction Application submitted by The Company to a Transmission Owner pursuant to Section D, Part Two, sub-paragraph 2.2.5:**

2.1 A System Construction Application submitted by The Company to a Transmission Owner pursuant to Section D, Part Two, sub-paragraph 2.2.5 shall contain the following information:

2.1.1 The User Application Date.

2.1.2 The date on which The Company wishes the System Construction to be made Operational.

Connect and Manage Arrangements

2.1.3 Confirmation whether the User has requested that the Enabling Works are to be greater in scope than the MITS Connection Works.

2.1.4 If the Enabling Works are to be greater in scope than the MITS Connection Works, details (to the extent available to The Company) of the concerns, reasons or technical requirements that this is seeking to address.

User Commitment Methodology

2.1.5 Confirmation that the above methodology is to be applied such that the Attributable Works provisions are/are not required.

SCHEDULE EIGHT

TO CONSTRUCTION OFFER

1. Requirements of a TO Construction Offer

1.1 Unless otherwise agreed with The Company, a TO Construction Offer shall be signed by the Transmission Owner and shall include the information set out in Transmission Licence Condition D4A or E17 as appropriate and, to the extent that such information does not otherwise require it, shall also include the following:

1.1.1 a description of any Change(s) to its Transmission System required to give effect to the Construction Project;

1.1.2 a description of any associated variation in the Transmission Services to be provided to The Company under Section C, Part One, paragraph 2.1 and including (where appropriate) any new or revised Normal Capability Limits that will apply;

1.1.3 a contract (a "**TO Construction Agreement**") for the construction of those Changes to its Transmission System described in paragraph 1.1.1, which is capable of being entered into by The Company and which binds The Company upon signature, and which shall contain the following:

1.1.3.1 commercial terms in, or substantially in, the form set out in Schedule Nine;

1.1.3.2 a description (in the form of Appendices) of any of the following types of works required to be undertaken by the Transmission Owner to give effect to the Construction Project:

(a) Transmission Connection Asset Works;

(b) Transmission Reinforcement Works;

(c) Seven Year Statement Works;

(d) One Off Works;

(e) Transmission Interface Asset Works;

(f) Embedded Transmission Interface Asset Works; and

(g) such additional works as are required in order to comply with any relevant Consents in relation to any of the works in (a) - (f) above,

(referred to together as the "**Transmission Construction Works**")

- 1.1.3.3 Appendices setting out any User Works and Third Party Works, respectively, associated with the Construction Project;
- 1.1.3.4 an Appendix setting out the TO Construction Programme, including the date on which the Transmission Construction Works shall be completed;
- 1.1.3.5 the Independent Engineer for the purposes of the TO Construction Agreement;
- 1.1.3.6 the date by which The Company, the Transmission Owner or the User shall have commenced, or shall be ready to commence, the Commissioning Programme;
- 1.1.3.7 the Completion Date; and
- 1.1.3.8 such other terms as are or may be appropriate for the purpose of the TO Construction Agreement (including, without limitation, any Liquidated Damages).
- 1.1.4 the likely material effect of Transmission Construction Works on other third parties (not including the User to whose User Application the TO Construction Offer relates);
- 1.1.5 any Outage(s) forming part of or otherwise associated with the Transmission Construction Works;
- 1.1.6 a description of any assumptions, technical limitations or works of other Parties which the TO Construction Offer is based upon and which are likely to be associated with the provision of Transmission Services at the Connection Site, New Connection Site, Transmission Interface Site or New Transmission Interface Site, Embedded Transmission Interface Site or New Embedded Transmission Interface Site or otherwise in relation to the construction of the relevant parts of the Construction Project including (without limitation) any SYS Works proposed for another Party's Transmission System which are required to be undertaken in order for the Transmission Owner to give effect to the TO Construction Offer;
- 1.1.7 a description of any technical design or operational criteria which the Transmission Owner reasonably considers User or Transmission Owner Equipment would be required to meet in order for such Transmission Owner to comply with Standard Condition D3 or Standard Condition E16 of its Transmission Licence as applicable.
- 1.2 In the case of a TO Construction Offer in relation to a New Connection, such TO Construction Offer may contain some or all of the following conditions:
 - 1.2.1 That The Company shall procure that the User enters into an Interface Agreement with the Transmission Owner covering the New Connection Site in a form to be agreed between the Transmission Owner and User but substantially in the form set out in Schedule O of the CUSC.

SCHEDULE NINE

TO CONSTRUCTION TERMS

A. PRO FORMA TERMS FOR TO CONSTRUCTION AGREEMENT BETWEEN THE COMPANY AND A TRANSMISSION OWNER UNDERTAKING WORKS WHICH INCLUDE WORKS AT A RELEVANT CONNECTION SITE (OR IN THE CASE OF OTSDUW BUILD AT A TRANSMISSION INTERFACE SITE).

1. Definitions and Interpretation

1.1 Unless the subject matter or context otherwise requires or is inconsistent therewith, terms and expressions in this TO Construction Agreement shall have the same meanings, interpretations or constructions as set out in Section J of the Code.

1.2 For the purposes of this TO Construction Agreement,

1.2.1 "**Consents**" means, in relation to any Transmission Construction Works:

- (a) all such planning and other statutory consents; and
- (b) all wayleaves, easements, rights over or interests in land or any other consent; or
- (c) permission of any kind as shall be necessary for the construction of the Works or Planned Works and for commencement and carrying on of any activity proposed to be undertaken at or from such Transmission Construction Works when completed;

1.3 The Relevant Connection Site (or in the case of OTSDUW Build, prospective Transmission Interface Site) and Works to which this TO Construction Agreement applies shall be as set out in the relevant Appendices to this TO Construction Agreement.

2. Carrying out of the Works

2.1 Forthwith following the Effective Date, the Transmission Owner and the User shall agree the Safety Rules and Local Safety Instructions to apply during the TO Construction Programme and TO Commissioning Programme. Failing agreement within three months of the Effective Date, the matter shall be referred to the Independent Engineer for determination in accordance with paragraph 5 of this TO Construction Agreement.

2.2 In relation to a Relevant Connection Site (or in the case of OTSDUW Build, prospective Transmission Interface Site), the Transmission Owner shall, and The Company shall procure that the User shall, ensure that each other is supplied with a copy of the Safety

Rules current from time to time, including any site-specific Safety Rules, and also a copy of the Local Safety Instructions applicable at each Relevant Connection Site (or in the case of OTSDUW Build, prospective Transmission Interface Site) from time to time.

2.3 Subject to paragraphs 2.4 and 2.6 forthwith following the Effective Date, the Transmission Owner shall use its best endeavours to obtain in relation to the Transmission Construction Works (other than those which the User is to obtain) and NGESO shall use its best endeavours to procure that the User obtains in relation to the User Works (and any relevant Transmission Construction Works where so agreed with the relevant Transmission Owner), all Consents, all Consents. Each shall give advice and assistance to the other to the extent reasonably required by the other in the furtherance of these obligations. Further, each Party shall, and The Company shall procure that the User shall, so far as it is legally able to do so, grant to the other, or the User, all such wayleaves, easements, servitude rights or other rights over or interests (but not estates as regards land in England and Wales and not heritable or leasehold interests as regards land in Scotland) in land or any other consents reasonably required by the other or the User in order to enable the Works to be expeditiously completed and to enable that other to carry out its obligations to the other under this TO Construction Agreement and in all cases subject to such terms and conditions as are reasonable.

2.4 The following additional provisions shall apply in respect of the Consents and Transmission Construction Works:

2.4.1 All dates specified in this TO Construction Agreement are subject to the Transmission Owner obtaining Consents for the Transmission Construction Works (including if relevant those which the User is to obtain on the relevant Transmission Owner's behalf) in a form acceptable to it and within the time required to carry out the Transmission Construction Works in accordance with the TO Construction Programme.

2.4.2 In the event of:

- (a) the Consents not being obtained by the required date; or
- (b) the Consents being subject to conditions which affect the dates; or
- (c) the Transmission Owner wishing to amend the Transmission Construction Works to facilitate the granting of the Consents,

the Transmission Owner shall be entitled to revise the Transmission Construction Works (and as a consequence the relevant Appendices of this TO Construction Agreement which set out such Transmission Construction Works and any related charges) and all charges and all dates specified in this TO Construction Agreement and the Construction Programme. For the avoidance of doubt such revisions shall be at the Transmission Owner's absolute discretion and the consent of The Company is not required.

2.5 The Parties shall regularly update each other in writing or by such other means as the relevant Parties may agree as to progress made by them and, in the case of The Company, as to progress made by the User from time to time in the obtaining of relevant Consents pursuant paragraphs 2.3 or 2.4.

2.6 The Company shall be liable to pay to the Transmission Owner:

2.6.1 all of the Transmission Owner's Engineering Charges accrued; and

2.6.2 proper and reasonable out-of-pocket expenses incurred and/or paid or which the Transmission Owner is legally bound to incur or pay,

in seeking and obtaining the Consents the subject of paragraph 2.3 excluding any costs associated with the Seven Year Statement Works and any other works, to the extent that The Company has paid or is liable to pay such costs under another TO Construction Agreement.

The Company acknowledges these out of pocket ancillary expenses may include planning inquiries or appeals and the capital costs together with reasonable legal and surveyors costs of landowners or occupiers in acquiring permanent easements or other rights in respect of any electric line or underground cable forming part of the Transmission Connection Asset Works. This sum shall not include any capital costs incurred by the Transmission Owner in the acquisition by it of the freehold of any land upon which a land charge is payable. The Transmission Owner shall keep The Company informed of the level of such charges and expenses being incurred. The Company shall pay such sums within 30 (thirty) days of the date of the Transmission Owner's invoice therefor.

2.7 Paragraphs 2.2, 2.3, 2.4 and 2.5 of Section J of the Code relating to Consents shall apply to the construction arrangements set out in this TO Construction Agreement as if set out here in full.

2.8 The Company may by written notice to the Transmission Owner terminate this TO Construction Agreement at any time and upon termination prior to the date at which the Transmission Construction Works other than the Wider Transmission Works are Completed The Company shall in addition to the sums for which it is liable under paragraph 2.6 be liable to pay to the Transmission Owner a sum equal to the Transmission Owner's estimate or if applicable revised estimate of TO Final Sums. The Company shall pay such sums within 16 (sixteen) days of the date of the Transmission Owner's invoice(s) therefor and (where applicable) on termination the Transmission Owner shall disconnect the User's Equipment at the Relevant Connection Site (or in the case of OTSDUW Build, but only prior to appointment of the nominated Offshore Transmission Owner, the OTSUA at the prospective Transmission interface Site) and:

2.8.1 The Company shall procure that a User removes any of the User's Equipment (and OTSUA) on the Transmission Owner's land within six months of the date of termination or such longer period as may be agreed between the Transmission Owner and the User; and

- 2.8.2 the Transmission Owner shall remove any of the Transmission Connection Assets on the User's land within six months of the date of termination or such longer period as may be agreed between the Transmission Owner and the User.
- 2.9 The Transmission Owner shall be entitled to contract or sub-contract for the carrying out of its respective parts of the Works. The Company shall procure the commencement and carrying out of the User works to such stage of completion as shall render them capable of being Commissioned in accordance with the TO Construction Programme and the Transmission Owner or any contractor on its behalf shall be responsible for commencing and carrying out the Transmission Construction Works to such stage of completion as shall render them capable of being Commissioned in accordance with the TO Construction Programme.
- 2.10 The Company may, at its discretion, notify the Transmission Owner at any time in writing to discontinue, postpone or otherwise delay all or part of any Works or other activities under this TO Construction Agreement and may direct that the Transmission Owner produce an amended TO Construction Programme and/or TO Commissioning Programme accordingly, as a consequence of:
- 2.10.1 a User breaching any credit or security requirement pursuant to the CUSC or CUSC Construction Agreement;
- 2.10.2 a delay or failure by a User or another Joint Project Party to obtain any Consents; or
- 2.10.3 a delay or failure by another Joint Project Party under and pursuant to any other TO Construction Agreement in respect of the same Construction Project.
- 2.11 During the period of and at the times and otherwise as provided in the TO Construction Programme and the TO Commissioning Programme the Transmission Owner shall allow the User, its employees, agents, suppliers, contractors and subcontractors and The Company shall ensure that the User allows (in relation to its sites) the Transmission Owner, its employees, agents, suppliers, contractors and sub-contractors, necessary access to its site to enable each to carry out the Transmission Connection Asset Works and One Off Works or User Works but not so as to disrupt or delay the construction and completion of the other's Works on the said sites or the operation of any other's Plant and Apparatus located thereon, such access to be in accordance with any reasonable regulations relating thereto made by the site owner or occupier.
- 2.12 Not later than six months prior to the Commissioning Programme Commencement Date, the Transmission Owner shall provide The Company with a draft TO Commissioning Programme for the Commissioning of the Transmission Connection Assets, and the User's Equipment (and in the case of OTSDUW Build, the OTSUA). The Company shall, as quickly as practicable and in any event within three months of receipt thereof, determine whether or not to approve the proposed Commissioning Programme (which approval shall not be unreasonably withheld or delayed) and shall within such three month

period either notify the Transmission Owner of its approval or, in the event that The Company reasonably withholds its approval, notify the Transmission Owner of any changes or variations to the proposed commissioning programme recommended by The Company. If the Transmission Owner does not accept such changes or variation submitted by The Company any dispute shall be referred to the Independent Engineer for determination. The TO Commissioning Programme agreed between the parties or determined by the Independent Engineer as the case may be shall be implemented by the parties and their sub-contractors in accordance with its terms.

- 2.13 If at any time prior to the Completion Date it is necessary for the Transmission Owner or the Transmission Owner in its reasonable discretion wishes to make any addition to or omission from or amendment to its Transmission Connection Asset Works and/or Transmission Reinforcement Works and/or the One Off Works and/or the Third Party Works the Transmission Owner shall notify The Company in writing of such addition, omission or amendment and the relevant Appendix of this TO Construction Agreement shall be automatically amended to reflect the change.
- 2.14 Transmission Reinforcement Works are conditional on any relevant nuclear generator granting approval to the carrying out of the Transmission Construction Works in terms of any Nuclear Site Licence Provisions Agreement. In the event of the relevant nuclear generator not granting approval the Transmission Owner shall be entitled to change the Transmission Construction Works, the TO Construction Programme and all dates specified in this TO Construction Agreement.
- 2.15 It is hereby agreed and declared for the purposes of the Construction (Design and Management) Regulations 2015 that the Transmission Owner is the only client in respect of the Transmission Construction Works (except any works that are carried out by a User on behalf of the relevant Transmission Owner, in which case the duties under the Construction (Design and Management) Regulations 2015 shall be as detailed in the separate construction agreement between the relevant Transmission Owner and the User) and shall accordingly discharge all the duties of a client under the said Regulations.
- 2.16 The Transmission Owner and The Company hereby agree and acknowledge that this TO Construction Agreement is not to be treated as a construction contract within the meaning of section 104 of the Housing Grants, Construction and Re-generation Act 1996 and sections 104 to 113 of the said Act shall have no application to any part of the Transmission Construction Works and the Parties' rights and obligations with regard to matters of dispute resolution and payment procedures are as expressly set out herein.
- 2.17 Connect And Manage Arrangements. [*connect and manage arrangements only*]. The Transmission Owner shall keep The Company advised as to progress on the Wider Transmission Reinforcement Works.

3. DELAYS

- 3.1 If either Party shall have reason to believe that it, another Transmission Owner or, in the case of The Company a User, is being delayed or will be delayed in carrying out that Party's or a User's Works (as appropriate) for any reason (whether it is one entitling it to

the fixing of a new date under paragraph 3.2 of this TO Construction Agreement or not) it shall forthwith notify the other Party in writing of the circumstances giving rise to the delay and of the extent of the actual and/or anticipated delay.

- 3.2 If prior to the Completion Date a Party (in this paragraph 3.2 the "**Affected Party**") shall be delayed in carrying out any of the Affected Party's Works (including their commissioning) by reason of (a) any act, default or omission on the part of the other Party (in this paragraph the "**Defaulting Party**") or of the Defaulting Party's employees, agents, contractors, sub-contractors or, in the case where The Company is the Defaulting Party, by reason of a delay by the User or (b) any act, default or omission on the part of any Transmission Owner which is not a Party to this TO Construction Agreement or its employees, agents, contractors or subcontractors or (c) by reason of an event of Force Majeure, the Affected Party shall be entitled to have such later date or dates fixed as the Commissioning Programme Commencement Date and/or (as the case may be) the Completion Date as may be fair and reasonable in the circumstances provided that it shall have notified the Defaulting Party in writing of such act, default or omission or event of Force Majeure within 28 days of it becoming aware of the occurrence giving rise to the delay together with an estimate of the proposed delay which it will cause the Affected Party. In the event of a dispute between the parties over what is or are any fair and reasonable date or dates to be fixed in the circumstance this shall be promptly referred to and determined by the Independent Engineer. Once the new date or dates are fixed the TO Construction Programme and/or TO Commissioning Programme shall be deemed automatically amended as appropriate.

4. **COMMISSIONING PROGRAMME AND LIQUIDATED DAMAGES**

- 4.1 Each Party shall give written notice to the other declaring its readiness to commence the Commissioning Programme when this is the case.
- 4.2 The Commissioning Programme shall commence forthwith once both Parties shall have given written notice to the other under paragraph 4.1.
- 4.3 The Transmission Construction Works shall be deemed to have been Commissioned on the date that the Independent Engineer certifies in writing to that effect.
- 4.4 In the event that the actual date of commencement of the Commissioning Programme shall be later than the Commissioning Programme Commencement Date the Transmission Owner (if and to the extent that it is responsible for delayed commissioning beyond the Commissioning Programme Commencement Date, such responsibility and/or its extent to be determined by the Independent Engineer failing agreement between the parties) shall be liable to pay to The Company Liquidated Damages for each day that the actual date of commencement of the Commissioning Programme is later than the Commissioning Programme Commencement Date. It is declared and agreed that such Liquidated Damages shall cease to be payable in respect of any period after the date of actual commencement of the Commissioning Programme.
- 4.5 In the event that the actual date on which the Transmission Construction Works are Commissioned is later than the Completion Date the Transmission Owner (if and to the

extent that it is responsible for delayed completion beyond the Completion Date, such responsibility and/or its extent to be determined by the Independent Engineer failing agreement between the Parties) shall be liable to pay to The Company Liquidated Damages for each day that the actual date on which the Transmission Construction Works are Commissioned is later than the Completion Date. It is hereby agreed and declared that such Liquidated Damages shall cease to be payable in respect of any period after completion of the Transmission Construction Works.

- 4.6 Liquidated Damages payable under paragraphs 4.4 and 4.5 shall accumulate on a daily basis but shall be payable calendar monthly. On or before the 13th day of each month the Party entitled to receive the payment of Liquidated Damages shall send to the other Party a statement of the Liquidated Damages which have accrued due in the previous calendar month. The Party receiving such statement shall in the absence of manifest error pay the Liquidated Damages shown on the statement within 28 days of the date upon which the statement is received.
- 4.7 Without prejudice to and in addition to the obligation of The Company pursuant to paragraph 2.6 the payment or allowance of Liquidated Damages pursuant to this paragraph 4 shall be in full satisfaction of the Transmission Owner's liability for failure to perform its obligations by the Commissioning Programme Commencement Date and/or the Completion Date as appropriate.
- 4.8 In the event that The Company or a User shall have failed, in circumstances not entitling The Company to the fixing of a new date as the Commissioning Programme Commencement Date pursuant to paragraph 3.2, to procure that the User complete the User Works by the Construction Backstop Date to a stage where The Company or such User (as appropriate) is ready to commence the Commissioning Programme, the Transmission Owner shall have the right to terminate this TO Construction Agreement upon giving notice in writing to The Company. In the event of such termination The Company shall in addition to the amounts for which it is liable under paragraph 2.6, also be liable to the Transmission Owner to pay a sum equal to the Transmission Owner's estimate or revised estimate of TO Final Sums. The Company shall pay such sums within 14 (fourteen) days of the date of the Transmission Owner's invoice(s) therefor and on termination (where applicable) The Transmission Owner shall disconnect the User Equipment at the Relevant Connection Site and (a) The Company shall ensure that the User shall remove any of the User Equipment on the Transmission Owner's land within six months of the date of termination or such longer period as may be agreed between the Transmission Owner and the User and (b) the Transmission Owner shall remove any Transmission Connection Assets on the User's land within six months of the date of termination or such longer period as may be agreed between the Transmission Owner and the User.

5. **INDEPENDENT ENGINEER**

In relation to matters raised pursuant to this TO Construction Agreement, the Parties agree and shall procure that the Independent Engineer shall act as an expert and not as an arbitrator and shall decide those matters referred or reserved to them under this TO

Construction Agreement by reference to Good Industry Practice using their skill, experience and knowledge and with regard to such other matters as the Independent Engineer in their sole discretion considers appropriate. All references to the Independent Engineer shall be made in writing by either Party with notice to the other being given contemporaneously as soon as reasonably practicable and in any event within 16 days of the occurrence of the dispute to be referred to the Independent Engineer. The Parties shall promptly supply the Independent Engineer with such documents and information as they may request when considering such question. The Independent Engineer shall use their best endeavours to give their decision upon the question before them as soon as possible following its referral to them. The Parties shall share equally the fees and expenses of the Independent Engineer. The Parties expressly acknowledge that submission of disputes for resolution by the Independent Engineer does not preclude subsequent submission of disputes for resolution by arbitration as provided in Section H of the Code. Pending any such submission the parties shall treat the Independent Engineer's decision as final and binding.

6. BECOMING OPERATIONAL

- 6.1 Without prejudice to paragraph 5 and subject to the provisions of this TO Construction Agreement, the Transmission Owner shall assist The Company in Connecting and Energising the User Equipment at the Relevant Connection Site (or in the case of OTSDUW Build, the OTSUA at the prospective Transmission interface Site) including by:
- (a) completing any Works required to be completed by the Transmission Owner at the times and in such manner as set out in the TO Construction Programme; and
 - (b) completing any operations, tests or other activities required to be completed by the Transmission Owner at the times and in such manner as set out in the Commissioning Programme.

7. TO FINAL SUMS

- 7.1 Within 58 days of the date of termination of this TO Construction Agreement the Transmission Owner shall:
- (a) furnish The Company with a further statement showing a revised estimate of TO Final Sums and will provide as soon as practicable evidence of such costs having been incurred; and
 - (b) by written notice to The Company inform The Company of all capital items which cost the Transmission Owner in excess of £10,000 and in relation to which an amount on account of TO Final Sums shall have been paid and whether the Transmission Owner (1) wishes to retain the said capital items or (2) dispose of them.
- 7.2 In respect of all capital items which the Transmission Owner wishes to retain (other than those which have been, or are proposed to be installed as a replacement for Transmission Plant and Transmission Apparatus) the Transmission Owner shall forthwith

reimburse to The Company the amount paid by The Company on account of TO Final Sums in respect of the said capital items (including without limitation the amount paid on account of the design, purchase, installation and testing of the said capital item and also associated construction works and interest charges) together with interest calculated thereon on a daily basis from the date of termination of this TO Construction Agreement to the date of payment at Base Rate for the time being and from time to time provided that in the event that the Transmission Owner wishes to retain any capital item which has been installed but wishes to remove it to storage or to another site then it shall only reimburse to The Company the cost of the capital item and not the costs of such installation and shall deduct from any reimbursement due to The Company the costs of removal and/or storage.

- 7.3 In respect of all capital items which the Transmission Owner wishes to dispose (other than those which have been, or are proposed to be installed as a replacement for Transmission Plant and Transmission Apparatus) it shall forthwith (and subject to the Transmission Owner obtaining the consent of the Authority under its Transmission Licence if required) sell or procure the sale of the said capital item on an arms-length basis as soon as reasonably practicable. Forthwith upon receipt of the sale proceeds the Transmission Owner shall pay to The Company the proceeds received from any such sale together with interest thereon calculated on a daily basis from the date of termination to the date of payment at Base Rate for the time being and from time to time less any reasonable costs associated with the sale including the costs and expenses reasonably incurred and/or paid and/or which the Transmission Owner is legally bound to pay on removing the capital item, any storage charges and any costs reasonably incurred by the Transmission Owner in respect of reinstatement associated with removal of the capital item. The Transmission Owner shall provide The Company with reasonably sufficient evidence of all such costs and expenses having been incurred. If the Authority does not agree to the disposal of the capital item the capital item shall be retained by the Transmission Owner and the Transmission Owner shall reimburse The Company the notional current market value in situ of the said capital item as between a willing buyer and a willing seller as agreed between the Parties and failing agreement as determined pursuant to Section H of the Code together with interest thereon calculated on a daily basis from the date of termination of this TO Construction Agreement to the date of payment at Base Rate for the time being and from time to time.
- 7.4 As soon as reasonably practicable after termination of this TO Construction Agreement the Transmission Owner shall provide The Company with a statement of and invoice for the TO Final Sums together with evidence of such costs having been incurred and/or paid and/or having been committed to be incurred. If the TO Final Sums are greater than the payments made by The Company in respect of the Transmission Owner's estimate(s) of TO Final Sums The Company shall within 35 days of the said statement and invoice prepared by the Transmission Owner pay to the Transmission Owner the additional payments due by The Company together with interest calculated thereon on a daily basis at Base Rate for the time being and from time to time from the date of previous payment(s) sums equal to the Transmission Owner's estimate of TO Final Sums to the date of the statement of and invoice for TO Final Sums. If the TO Final Sums is less than the payments made by The Company in respect of the Transmission Owner's estimate of TO

Final Sums paid by The Company following termination of this TO Construction Agreement the Transmission Owner shall forthwith pay to The Company the excess paid together with interest on a daily basis at the Base Rate for the time being and from time to time from the date of payment of the fair and reasonable estimate of TO Final Sums to the date of reimbursement by the Transmission Owner of the said excess paid.

7.5 **Provision of Bi-annual Estimate**

The Transmission Owner shall provide to The Company an estimate ("the **Bi-annual Estimate**") in substantially the form set out in the relevant Appendix to this TO Construction Agreement and showing the amounts of all payments required or which may be required to be made by The Company to the Transmission Owner in respect of TO Final Sums and Engineering Charges and other expenses in relation to seeking Consents referred to in paragraph 2.4 at the following times and in respect of the following periods:-

- (a) forthwith and on and with effect from the Effective Date, in respect of the period from the Effective Date until the next following 31st March or 30th September (whichever shall first occur); and
- (b) not less than 82 (eighty-two) days (or if such day is not a Business Day the next following Business Day) prior to each 31st March and 30th September thereafter in respect of the period of six calendar months commencing on the immediately following 1st April or 1st October (as the case may be), until this TO Construction Agreement shall be terminated or shall expire in accordance with paragraph 8.

The Transmission Owner shall provide The Company with all advice and assistance reasonably requested by The Company in relation to any discussions or correspondence with a User in connection with Bi-annual Estimates.

7.6 **Entitlement to Estimate**

If the Transmission Owner is (for whatever reason) unable on any relevant date to calculate precisely any sum due or which has accrued due or in respect of which The Company has a liability to the Transmission Owner for payment under any of the provisions of this TO Construction Agreement, the Transmission Owner shall be entitled to invoice The Company for a sum equal to the Transmission Owner's fair and reasonable estimate of the sums due or which may become due or in respect of which The Company has a liability to the Transmission Owner for payment. The Transmission Owner shall also be entitled to send The Company further invoices for such sums not covered in previous invoices. The Company shall pay the Transmission Owner all sums so invoiced by the Transmission Owner.

8. **TERM**

- 8.1 Subject to the provisions for earlier termination set out in the Code, this TO Construction Agreement shall continue in force unless and until terminated in accordance with paragraphs 2.8, or 4.8.

8.2 Any provisions for payment survive the termination of this TO Construction Agreement.

9. **THE CODE**

9.1 The provisions of:

9.1.1 Section E (Payment);

9.1.2 Section F (Confidentiality);

9.1.3 Section G, paragraphs 5 (Third Party Rights), 6 (Transfer and Sub-contracting), 7 (Intellectual Property), 8 (Force Majeure), 9 (Privilege), 10 (Waiver), 11 (Nominated Representative), 12 (Communications), 13 (Counterparts), 14 (Severance of Terms), 15 (Language), 16 (Data Protection Act), 17 (Jurisdiction), 18 (Governing Law), 19 (No Partnership)

of the Code shall apply to this TO Construction Agreement as if set out in this TO Construction Agreement in full.

10. **DISPUTES**

10.1 Except as specifically provided for in this TO Construction Agreement any dispute arising under the terms of this TO Construction Agreement shall be referred to arbitration in accordance with the terms of Section H of the Code.

11. **VARIATIONS**

11.1 Subject to paragraphs 11.2 and 11.3 below, no variation to this TO Construction Agreement shall be effective unless made in writing and signed by or on behalf of both the Transmission Owner and The Company.

11.2 The Transmission Owner and The Company shall effect any amendment required to be made to this TO Construction Agreement by the Authority as a result of a change in the Code or a Licence or an order or direction made pursuant to the Act or a Licence. The Company hereby authorises and instructs the Transmission Owner to make any such amendments on its behalf and undertakes not to withdraw, qualify or revoke such authority or instruction at any time.

11.3 The Transmission Owner has the right to vary any Appendices to this TO Construction Agreement in accordance with paragraphs 2.4 or 2.13.

[12 **ATTRIBUTABLE WORKS** *where applicable only*]

12.1 The Transmission Owner shall provide to The Company (in a form agreed between the Transmission Owner and The Company) the following information at the following times (or such other times as agreed between the Transmission Owner and The Company):-

(a) by reference to each component of the Attributable Works, forthwith on the Effective Date and then not less than 82 (eighty-two) days (or if such day is not

a Business Day the next following Business Day) prior to each 31st March and 30th September thereafter (until this TO Construction Agreement shall be terminated or shall expire in accordance with paragraph 8 or until The Company notifies the Transmission Owner that it is no longer required):

- (i) an estimate of the Attributable Works Capital Cost;
 - (ii) an estimate of capability in MW;
 - (iii) an assessment of the actual or potential for reuse and any strategic benefits provided as a percentage of the estimate provided at (i); and
- (b) by reference to each component of the Attributable Works, forthwith and on and with effect from the Effective Date, in respect of the period from the Effective Date until the next following 31st March or 30th September (whichever shall first occur) an estimate of the Attributable Works Capital Cost; and
- (c) by reference to each component of the Attributable Works, not less than 82 (eighty-two) days (or if such day is not a Business Day the next following Business Day) prior to each 31st March and 30th September thereafter in respect of the period of six calendar months commencing on the immediately following 1st April or 1st October (as the case may be) (until this TO Construction Agreement shall be terminated or shall expire in accordance with paragraph 8 or until The Company notifies the Transmission Owner that it is no longer required), an estimate of the Attributable Works Capital Cost.

12.2 On termination of this TO Construction Agreement and where requested by The Company to do so the Transmission Owner shall together with the statements and information provided to The Company by the Transmission Owner pursuant to paragraphs 7.1 to 7.5 in respect of the TO Final Sums, provide statements and information in a form agreed between the Transmission Owner and The Company in respect of the amount within the TO Final Sums which represents the actual Attributable Works Capital Cost of each component within the Attributable Works and also a justification of and supporting information in respect of the Transmission Owners assessment of the actual or potential for reuse and any strategic benefits of the Attributable Works and any of the resulting assets.

12.3 The Transmission Owner shall provide The Company with all advice and assistance and information reasonably requested by The Company in relation to any discussions or correspondence with a User in connection with the Attributable Works Capital Cost and assessment of the actual or potential for reuse and any strategic benefits of the Attributable Works and any of the resulting assets including the calculation and/or estimation of the same.

B. PROFORMA TERMS FOR TO CONSTRUCTION AGREEMENT BETWEEN THE COMPANY AND A TRANSMISSION OWNER ONLY UNDERTAKING WORKS WHICH ARE NOT AT A RELEVANT CONNECTION SITE.

1. Definitions and Interpretation

1.1 Unless the subject matter or context otherwise requires or is inconsistent therewith, terms and expressions in this TO Construction Agreement shall have the same meanings, interpretations or constructions as set out in Section J of the Code.

1.2 For the purposes of this TO Construction Agreement,

1.2.1 "**Consents**" means, in relation to any Transmission Construction Works:

- (a) all such planning and other statutory consents; and
- (b) all wayleaves, easements, rights over or interests in land or any other consent; or
- (c) permission of any kind as shall be necessary for the construction of the Works and for commencement and carrying on of any activity proposed to be undertaken at or from such Transmission Construction Works when completed.

1.3 The Relevant Connection Site and Works to which this TO Construction Agreement applies shall be as set out in the relevant Appendices to this TO Construction Agreement.

2. Carrying out of the Works

2.1 Subject to paragraph 2.2, forthwith following the Effective Date, the Transmission Owner shall use its best endeavours to obtain in relation to the Transmission Construction Works (other than those which the User is to obtain) and The Company shall use its best endeavours to procure that the User obtains in relation to the User Works (and any relevant Transmission Construction Works where so agreed with the relevant Transmission Owner), all Consents. Each shall give advice and assistance to the other to the extent reasonably required by the other in the furtherance of these obligations. Further, each Party shall, and The Company shall procure that the User shall, so far as it is legally able to do so, grant to the other, or the User, all such wayleaves, easements, servitude rights or other rights over or interests (but not estates as regards land in England and Wales and not heritable or leasehold interests as regards land in Scotland) in land or any other consents reasonably required by the other or the User in order to enable the Works to be expeditiously completed and to enable that other to carry out its obligations to the other under this TO Construction Agreement and in all cases subject to such terms and conditions as are reasonable.

2.2 The following additional provisions shall apply in respect of the Consents and Transmission Construction Works:

2.2.1 All dates specified in this TO Construction Agreement are subject to the Transmission Owner obtaining Consents for the Transmission Construction Works (including if relevant those which the User is to obtain on the relevant Transmission Owner's behalf) in a form acceptable to it and within the time required to carry out the Transmission Construction Works in accordance with the TO Construction Programme.

2.2.2 In the event of:-

- (a) the Consents not being obtained by the required date; or
- (b) the Consents being subject to conditions which affect the dates; or
- (c) the Transmission Owner wishing to amend the Transmission Construction Works to facilitate the granting of the Consents,

the Transmission Owner shall be entitled to revise the Transmission Construction Works (and as a consequence the relevant Appendices of this TO Construction Agreement which set out such Transmission Construction Works and any related charges) and all charges and all dates specified in this TO Construction Agreement and the Construction Programme. For the avoidance of doubt such revisions shall be at the Transmission Owner's absolute discretion and the consent of The Company is not required.

2.3 The Parties shall regularly update each other in writing or by such other means as the relevant Parties may agree as to progress made by them and, in the case of The Company, as to progress made by the User from time to time in the obtaining of relevant Consents pursuant paragraphs 2.1 or 2.2.

2.4 The Company shall be liable to pay to the Transmission Owner:

2.4.1 all of the Transmission Owner's Engineering Charges accrued; and

2.4.2 proper and reasonable out-of-pocket expenses incurred and/or paid or which the Transmission Owner is legally bound to incur or pay,

in seeking and obtaining the Consents the subject of paragraph 2.1 excluding any costs associated with the Seven Year Statement Works and any other works, to the extent that The Company has paid or is liable to pay such costs under another TO Construction Agreement.

The Company acknowledges these out of pocket ancillary expenses may include planning inquiries or appeals and the capital costs together with reasonable legal and surveyors costs of landowners or occupiers in acquiring permanent easements or other rights in respect of any electric line or underground cable forming part of the Transmission Connection Asset Works. This sum shall not include any capital costs incurred by the Transmission Owner in the acquisition by it of the freehold of any land upon which a land charge is payable. The Transmission Owner shall keep The Company informed of the

level of such charges and expenses being incurred. The Company shall pay such sums within 30 (thirty) days of the date of the Transmission Owner's invoice therefor.

- 2.5 Paragraphs 2.2, 2.3, 2.4 and 2.5 of Section J of the Code relating to Consents shall apply to the construction arrangements set out in this TO Construction Agreement as if set out here in full.
- 2.6 The Company may by written notice to the Transmission Owner terminate this TO Construction Agreement at any time and upon termination prior to the date at which the Transmission Construction Works other than the Wider Transmission Reinforcement Works are Completed The Company shall in addition to the sums for which it is liable under paragraph 2.4 be liable to pay to the Transmission Owner a sum equal to the Transmission Owner's estimate or if applicable revised estimate of TO Final Sums. The Company shall pay such sums within 16 (sixteen) days of the date of the Transmission Owner's invoice(s) therefor.
- 2.7 The Transmission Owner shall be entitled to contract or sub-contract for the carrying out of its respective parts of the Works. The Company shall procure the commencement and carrying out of the User works to such stage of completion as shall render them capable of being Commissioned in accordance with the TO Construction Programme and the Transmission Owner or any contractor on its behalf shall be responsible for commencing and carrying out the Transmission Construction Works to such stage of completion as shall render them capable of being Commissioned in accordance with the TO Construction Programme.
- 2.8 The Company may, at its discretion, notify the Transmission Owner at any time in writing to discontinue, postpone or otherwise delay all or part of any Works or other activities under this TO Construction Agreement and may direct that the Transmission Owner produce an amended TO Construction Programme accordingly, as a consequence of:
- 2.8.1 a User breaching any credit or security requirement pursuant to the CUSC or CUSC Construction Agreement;
 - 2.8.2 a delay or failure by a User or another Joint Project Party to obtain any Consents; or
 - 2.8.3 a delay or failure by another Joint Project Party under and pursuant to any other TO Construction Agreement in respect of the same Construction Project.
- 2.9 If at any time prior to the Completion Date it is necessary for the Transmission Owner or the Transmission Owner in its reasonable discretion wishes to make any addition to or omission from or amendment to its Transmission Reinforcement Works and/or the One Off Works and/or the Third Party Works the Transmission Owner shall notify The Company in writing of such addition, omission or amendment and the relevant Appendix of this TO Construction Agreement shall be automatically amended to reflect the change.
- 2.10 Transmission Reinforcement Works are conditional on any relevant nuclear generator granting approval to the carrying out of the Transmission Construction Works in terms of

any Nuclear Site Licence Provisions Agreement. In the event of the relevant nuclear generator not granting approval the Transmission Owner shall be entitled to change the Transmission Construction Works, the TO Construction Programme and all dates specified in this TO Construction Agreement.

- 2.11 It is hereby agreed and declared for the purposes of the Construction (Design and Management) Regulations 2015 that the Transmission Owner is the only client in respect of the Transmission Construction Works (except any works that are carried out by a User on behalf of the relevant Transmission Owner, in which case the duties under the Construction (Design and Management) Regulations 2015 shall be as detailed in the separate construction agreement between the relevant Transmission Owner and the User) and shall accordingly discharge all the duties of a client under the said Regulations.
- 2.12 The Transmission Owner hereby agrees and acknowledges that this TO Construction Agreement is not to be treated as a construction contract within the meaning of section 104 of the Housing Grants, Construction and Re-generation Act 1996 and sections 104 to 113 of the said Act shall have no application to any part of the Transmission Construction Works and the Parties' rights and obligations with regard to matters of dispute resolution and payment procedures are as expressly set out herein.
- 2.13 Connect And Manage Arrangements. [*connect and manage arrangements only*]. The Transmission Owner shall keep The Company advised as to progress on the Wider Transmission Reinforcement Works.

3. DELAYS

- 3.1 If either Party shall have reason to believe that it, another Transmission Owner or, in the case of The Company a User, is being delayed or will be delayed in carrying out that Party's or a User's Works (as appropriate) for any reason (whether it is one entitling it to the fixing of a new date under paragraph 3.2 of this TO Construction Agreement or not) it shall forthwith notify the other Party in writing of the circumstances giving rise to the delay and of the extent of the actual and/or anticipated delay.
- 3.2 If prior to the Completion Date a Party (in this paragraph 3.2 the "**Affected Party**") shall be delayed in carrying out any of the Affected Party's Works (including their commissioning) by reason of (a) any act, default or omission on the part of the other Party (in this paragraph the "**Defaulting Party**") or of the Defaulting Party's employees, agents, contractors, sub-contractors or, in the case where The Company is the Defaulting Party, by reason of a delay by the User or (b) any act, default or omission on the part of any Transmission Owner which is not a Party to this TO Construction Agreement or its employees, agents, contractors or subcontractors or (c) by reason of an event of Force Majeure, the Affected Party shall be entitled to have such later date or dates fixed as the Completion Date as may be fair and reasonable in the circumstances provided that it shall have notified the Defaulting Party in writing of such act, default or omission or event of Force Majeure within 28 days of it becoming aware of the occurrence giving rise to the delay together with an estimate of the proposed delay which it will cause the Affected Party. In the event of a dispute between the parties over what is or are any fair and

reasonable date or dates to be fixed in the circumstance this shall be promptly referred to and determined by the Independent Engineer. Once the new date or dates are fixed the TO Construction Programme shall be deemed automatically amended as appropriate.

4. COMMISSIONING PROGRAMME AND LIQUIDATED DAMAGES

4.1 The Transmission Construction Works shall be deemed to have been Commissioned on the date that the Independent Engineer certifies in writing to that effect.

4.2 In the event that the actual date on which the Transmission Construction Works are Commissioned is later than the Completion Date the Transmission Owner (if and to the extent that it is responsible for delayed completion beyond the Completion Date, such responsibility and/or its extent to be determined by the Independent Engineer failing agreement between the Parties) shall be liable to pay to The Company Liquidated Damages for each day that the actual date on which the Transmission Construction Works are Commissioned is later than the Completion Date. It is hereby agreed and declared that such Liquidated Damages shall cease to be payable in respect of any period after completion of the Transmission Construction Works.

4.3 Liquidated Damages payable under paragraph 4.2 shall accumulate on a daily basis but shall be payable calendar monthly. On or before the 13th day of each month the Party entitled to receive the payment of Liquidated Damages shall send to the other Party a statement of the Liquidated Damages which have accrued due in the previous calendar month. The Party receiving such statement shall in the absence of manifest error pay the Liquidated Damages shown on the statement within 28 days of the date upon which the statement is received.

4.4 Without prejudice to and in addition to the obligation of The Company pursuant to paragraph 2.4 the payment or allowance of Liquidated Damages pursuant to this paragraph 4 shall be in full satisfaction of the Transmission Owner's liability for failure to perform its obligations by the Completion Date.

5. INDEPENDENT ENGINEER

In relation to matters raised pursuant to this TO Construction Agreement, the Parties agree and shall procure that the Independent Engineer shall act as an expert and not as an arbitrator and shall decide those matters referred or reserved to them under this TO Construction Agreement by reference to Good Industry Practice using their skill, experience and knowledge and with regard to such other matters as the Independent Engineer in their sole discretion considers appropriate. All references to the Independent Engineer shall be made in writing by either Party with notice to the other being given contemporaneously as soon as reasonably practicable and in any event within 14 days of the occurrence of the dispute to be referred to the Independent Engineer. The Parties shall promptly supply the Independent Engineer with such documents and information as they may request when considering such question. The Independent Engineer shall use their best endeavours to give their decision upon the question before them as soon as possible following its referral to them. The Parties shall share equally the fees and expenses of the Independent Engineer. The Parties expressly acknowledge that

submission of disputes for resolution by the Independent Engineer does not preclude subsequent submission of disputes for resolution by arbitration as provided in Section H of the Code. Pending any such submission the parties shall treat the Independent Engineer's decision as final and binding.

6. TO FINAL SUMS

6.1 Within 55 days of the date of termination of this TO Construction Agreement the Transmission Owner shall:

- (a) furnish The Company with a further statement showing a revised estimate of TO Final Sums and will provide as soon as practicable evidence of such costs having been incurred; and
- (b) by written notice to The Company inform The Company of all capital items which cost the Transmission Owner in excess of £10,000 and in relation to which an amount on account of TO Final Sums shall have been paid and whether the Transmission Owner (1) wishes to retain the said capital items or (2) dispose of them.

6.2 In respect of all capital items which the Transmission Owner wishes to retain (other than those which have been, or are proposed to be installed as a replacement for Transmission Plant and Transmission Apparatus) the Transmission Owner shall forthwith reimburse to The Company the amount paid by The Company on account of TO Final Sums in respect of the said capital items (including without limitation the amount paid on account of the design, purchase, installation and testing of the said capital item and also associated construction works and interest charges) together with interest calculated thereon on a daily basis from the date of termination of this TO Construction Agreement to the date of payment at Base Rate for the time being and from time to time provided that in the event that the Transmission Owner wishes to retain any capital item which has been installed but wishes to remove it to storage or to another site then it shall only reimburse to The Company the cost of the capital item and not the costs of such installation and shall deduct from any reimbursement due to the User the costs of removal and/or storage.

6.3 In respect of all capital items which the Transmission Owner wishes to dispose (other than those which have been, or are proposed to be installed as a replacement for Transmission Plant and Transmission Apparatus) it shall forthwith (and subject to the Transmission Owner obtaining the consent of the Authority under its Transmission Licence if required) sell or procure the sale of the said capital item on an arms-length basis as soon as reasonably practicable. Forthwith upon receipt of the sale proceeds the Transmission Owner shall pay to The Company the proceeds received from any such sale together with interest thereon calculated on a daily basis from the date of termination to the date of payment at Base Rate for the time being and from time to time less any reasonable costs associated with the sale including the costs and expenses reasonably incurred and/or paid and/or which the Transmission Owner is legally bound to pay on removing the capital item, any storage charges and any costs reasonably incurred by the

Transmission Owner in respect of reinstatement associated with removal of the capital item. The Transmission Owner shall provide The Company with reasonably sufficient evidence of all such costs and expenses having been incurred. If the Authority does not agree to the disposal of the capital item the capital item shall be retained by the Transmission Owner and the Transmission Owner shall reimburse The Company the notional current market value in situ of the said capital item as between a willing buyer and a willing seller as agreed between the Parties and failing agreement as determined pursuant to Section H of the Code together with interest thereon calculated on a daily basis from the date of termination of this TO Construction Agreement to the date of payment at Base Rate for the time being and from time to time.

- 6.4 As soon as reasonably practicable after termination of this TO Construction Agreement the Transmission Owner shall provide The Company with a statement of and invoice for the TO Final Sums together with evidence of such costs having been incurred and/or paid and/or having been committed to be incurred. If the TO Final Sums are greater than the payments made by The Company in respect of the Transmission Owner's estimate(s) of TO Final Sums The Company shall within 35 days of the said statement and invoice prepared by the Transmission Owner pay to the Transmission Owner the additional payments due by The Company together with interest calculated thereon on a daily basis at Base Rate for the time being and from time to time from the date of previous payment(s) sums equal to the Transmission Owner's estimate of TO Final Sums to the date of the statement of and invoice for TO Final Sums. If the TO Final Sums is less than the payments made by The Company in respect of the Transmission Owner's estimate of Final Sums paid by The Company following termination of this TO Construction Agreement the Transmission Owner shall forthwith pay to The Company the excess paid together with interest on a daily basis at the Base Rate for the time being and from time to time from the date of payment of the fair and reasonable estimate of TO Final Sums to the date of reimbursement by the Transmission Owner of the said excess paid.

6.5 Provision of Bi-annual Estimate

The Transmission Owner shall provide to The Company an estimate ("the Bi-annual Estimate") in substantially the form set out in the relevant Appendix to this TO Construction Agreement and showing the amounts of all payments required or which may be required to be made by The Company to the Transmission Owner in respect of TO Final Sums at the following times and in respect of the following periods:-

- (a) forthwith on and with effect from the Effective Date, in respect of the period from the Effective Date until the next following 31st March or 30th September (whichever shall first occur); and
- (b) not less than 82 (eighty-two) days (or if such day is not a Business Day the next following Business Day) prior to each 31st March and 30th September thereafter in respect of the period of six calendar months commencing immediately following 1st April or 1st October (as the case may be), until this TO Construction Agreement shall be terminated or shall expire in accordance with paragraph 7.

The Transmission Owner shall provide The Company with all advice and assistance reasonably requested by The Company in relation to any discussions or correspondence with a User in connection with Bi-annual Estimates.

6.6 Entitlement to Estimate

If the Transmission Owner is (for whatever reason) unable on any relevant date to calculate precisely any sum due or which has accrued due or in respect of which The Company has a liability to the Transmission Owner for payment under any of the provisions of this TO Construction Agreement, the Transmission Owner shall be entitled to invoice The Company for a sum equal to the Transmission Owner's fair and reasonable estimate of the sums due or which may become due or in respect of which The Company has a liability to the Transmission Owner for payment. The Transmission Owner shall also be entitled to send The Company further invoices for such sums not covered in previous invoices. The Company shall pay the Transmission Owner all sums so invoiced by the Transmission Owner.

7. TERM

7.1 Subject to the provisions for earlier termination set out in the Code, this TO Construction Agreement shall continue in force unless and until terminated in accordance with paragraph 2.6.

7.2 Any provisions for payment survive the termination of this TO Construction Agreement.

8. THE CODE

8.1 The provisions of:

8.1.1 Section E (Payment);

8.1.2 Section F (Confidentiality);

8.1.3 Section G, paragraphs 5 (Third Party Rights), 6 (Transfer and Sub-contracting), 7 (Intellectual Property), 8 (Force Majeure), 9 (Privilege), 10 (Waiver), 11 (Nominated Representative), 12 (Communications), 13 (Counterparts), 14 (Severance of Terms), 15 (Language), 16 (Data Protection Act), 17 (Jurisdiction), 18 (Governing Law), 19 (No Partnership)

of the Code shall apply to this TO Construction Agreement as if set out in this TO Construction Agreement in full.

9. DISPUTES

9.1 Except as specifically provided for in this TO Construction Agreement any dispute arising under the terms of this TO Construction Agreement shall be referred to arbitration in accordance with the terms of Section H of the Code.

10. **VARIATIONS**

- 10.1 Subject to paragraphs 10.2 and 10.3 below, no variation to this TO Construction Agreement shall be effective unless made in writing and signed by or on behalf of both the Transmission Owner and The Company.
- 10.2 The Transmission Owner and The Company shall effect any amendment required to be made to this TO Construction Agreement by the Authority as a result of a change in the Code or a Licence or an order or direction made pursuant to the Act or a Licence. The Company hereby authorises and instructs the Transmission Owner to make any such amendments on its behalf and undertakes not to withdraw, qualify or revoke such authority or instruction at any time.
- 10.3 The Transmission Owner has the right to vary any Appendices to this TO Construction Agreement in accordance with paragraph 2.9.

[11 **ATTRIBUTABLE WORKS** *where applicable only*]

- 11.1 The Transmission Owner shall provide to The Company (in a form agreed between the Transmission Owner and The Company) the following information at the following times (or such other times as agreed between the Transmission Owner and The Company):-
- (a) by reference to each component of the Attributable Works, forthwith on the Effective Date and then not less than 82 (eighty-two) days (or if such day is not a Business Day the next following Business Day) prior to each 31st March and 30th September thereafter (until this TO Construction Agreement shall be terminated or shall expire in accordance with paragraph 7 or until The Company notifies the Transmission Owner that it is no longer required):
 - (i) an estimate of the Attributable Works Capital Cost;
 - (ii) an estimate of capability in MW;
 - (iii) an assessment of the actual or potential for reuse and any strategic benefits provided as a percentage of the estimate provided at (i); and
 - (b) by reference to each component of the Attributable Works, forthwith and on and with effect from the Effective Date, in respect of the period from the Effective Date until the next following 31st March or 30th September (whichever shall first occur) an estimate of the Attributable Works Capital Cost; and
 - (c) by reference to each component of the Attributable Works, not less than 82 (eighty-two) days (or if such day is not a Business Day the next following Business Day) prior to each 31st March and 30th September thereafter in respect of the period of six calendar months commencing on the immediately following 1st April or 1st October (as the case may be) (until this TO Construction Agreement shall be terminated or shall expire in accordance with paragraph 7 or

until The Company notifies the Transmission Owner that it is no longer required),
an estimate of the Attributable Works Capital Cost.

- 11.2 On termination of this TO Construction Agreement and where requested by The Company to do so the Transmission Owner shall together with the statements and information provided to The Company by the Transmission Owner pursuant to paragraphs 6.1 to 6.5 in respect of the TO Final Sums, provide statements and information in a form agreed between the Transmission Owner and The Company in respect of the amount within the TO Final Sums which represents the actual Attributable Works Capital Cost of each component within the Attributable Works and also a justification of and supporting information in respect of the Transmission Owners assessment of the actual or potential for reuse and any strategic benefits of the Attributable Works and any of the resulting assets.
- 11.3 The Transmission Owner shall provide The Company with all advice and assistance and information reasonably requested by The Company in relation to any discussions or correspondence with a User in connection with the Attributable Works Capital Cost and assessment of the actual or potential for reuse and any strategic benefits of the Attributable Works and any of the resulting assets including the calculation and/or estimation of the same.

C. PRO FORMA TERMS FOR TO CONSTRUCTION AGREEMENT BETWEEN NGESO AND AN OFFSHORE TRANSMISSION OWNER UNDERTAKING WORKS WHICH INCLUDE WORKS AT A RELEVANT CONNECTION SITE.

DATED [_____]

[_____] (1)

and

NGESO (2)

TO CONSTRUCTION AGREEMENT

Reference: [_____]

CONTENTS

1. Definitions, Interpretation and Construction
2. Carrying out the Works
3. Delays
4. Commissioning Programme and Liquidated Damages
5. Independent Engineer
6. Approval to Connect\Becoming Operational
7. TO Final Sums
8. Term
9. The Code
10. Disputes and TO Event of Default
11. Variations

APPENDIX A CONNECTION SITE AND TRANSMISSION CONNECTION ASSETS

**APPENDIX B TRANSMISSION INTERFACE SITE/EMBEDDED TRANSMISSION
INTERFACE SITE**

APPENDIX C CONNECTION SITE – SITE SPECIFIC TECHNICAL REQUIREMENTS

**APPENDIX D TRANSMISSION INTERFACE SITE/EMBEDDED TRANSMISSION
INTERFACE SITE – SITE SPECIFIC TECHNICAL DESIGN AND
OPERATIONAL REQUIREMENTS**

**APPENDIX E TRANSMISSION INTERFACE SITE SPECIFICATION/EMBEDDED
TRANSMISSION INTERFACE SITE SPECIFICATION**

APPENDIX F CONNECTION SITE SPECIFICATION

APPENDIX G TRANSMISSION CONNECTION ASSET WORKS

APPENDIX H TRANSMISSION REINFORCEMENT WORKS

APPENDIX I USER'S WORKS

APPENDIX J CONSTRUCTION PROGRAMME

- APPENDIX K LIQUIDATED DAMAGES**
- APPENDIX L ONE OFF WORKS**
- APPENDIX M SEVEN YEAR STATEMENT WORKS AND THIRD PARTY WORKS**
- APPENDIX N CONSENTS WORKS**
- APPENDIX O OFFSHORE WORKS CRITERIA**
- APPENDIX P USER DATA**
- APPENDIX Q TRANSMISSION INTERFACE SITE WORKS/EMBEDDED
TRANSMISSION INTERFACE SITE WORKS**
- APPENDIX R INITIAL SERVICES CAPABILITY SPECIFICATION**
- APPENDIX S MATTERS FOR COMPLETION REPORT**
- APPENDIX T TO EVENT OF DEFAULT**
- APPENDIX U TRANSMISSION OWNER [CHARGES\COSTS] [AND FORECAST
OFFSHORE CONSTRUCTION COST AND OFFSHORE
CONSTRUCTION SECURED AMOUNT]**
- APPENDIX V FORM OF BI-ANNUAL ESTIMATE**
- APPENDIX W TRANSMISSION INTERFACE SITE SPECIFICATION/EMBEDDED
TRANSMISSION INTERFACE SITE SPECIFICATION**
- APPENDIX X ATTRIBUTABLE WORKS**

THIS [] is made on the [] day of [] 20 []

Between

- (1) [] a company registered in [] with number [] whose registered office is at [] (“**Transmission Owner**”) which expression shall include its successors and/or permitted assigns) and
- (2) **NGESO** a company registered in England with number [X] whose registered office is at 1 – 3 Strand, London, WC2N 5EH (and also referred to as “**The Company**”, which expression shall include its successors and/or permitted assigns).

WHEREAS

- (A) The Company has entered into an agreement with the User for connection to the National Electricity Transmission System at the Connection Site (the “Construction Project”)
- (B) The Transmission Owner has been appointed as for the provision of the Offshore Transmission System to which the User will be connected at the Connection Site.
- (C) The Offshore Transmission System is to connect to the Onshore Transmission System at the Transmission Interface Site] [Onshore Distribution System at the Embedded Transmission Interface Site].
- (D) The Company has made an The Company Connection Application to the Transmission Owner in accordance with Section D Part Two Paragraph 2 of the Code in respect of the Construction Project.
- (E) Following such The Company Connection Application the Transmission Owner is required to make a TO Construction Offer to The Company in accordance with STC Section D Part Two Paragraph 4 of the Code.
- (F) This Agreement sets out the terms of the TO Construction Offer

NOW IT IS HEREBY AGREED as follows:

1. DEFINITIONS AND INTERPRETATION

1.1 Unless the subject matter or context otherwise requires or is inconsistent therewith, terms and expressions in this TO Construction Agreement shall have the same meanings, interpretations or constructions as set out in Section J of the Code and the following terms and expressions shall have the meaning set out below:-

Attributable Works	in relation to the User those Transmission Construction Works set out in Appendix X Part 1.
Commissioning Programme	Means as appropriate the TO Commissioning Programme or the TI Commissioning Programme.

Completion Date	the date for completion of the Transmission Construction Works as set out in the TO Construction Programme.
Completion Report	the report to be produced by the Transmission Owner pursuant to Clause 6.2 and addressing the matters set out in Appendix S.
Confirmation of Compliance Statement	a statement prepared by the Transmission Owner which states that in the opinion of the Transmission Owner, acting as a reasonable and prudent operator, its Transmission System is compliant with the STC, NETS SQSS [Distribution Code] and those other standards specified in Appendix O to which it has designed and constructed its Transmission System.
Connection Site	the site of the connection to the National Electricity Transmission System as set out in Appendix A.
Consents	<p>means, in relation to any Transmission Construction Works:</p> <ul style="list-style-type: none"> (a) all such planning and other statutory consents <i>[excluding the Crown Estate Lease]</i>; and (b) all wayleaves, easements, rights over or interests in land or any other consent; or (c) permission of any kind as shall be necessary for the construction of the Works or Planned Works and for commencement and carrying on of any activity proposed to be undertaken at or from such Transmission Construction Works when completed; <p>[but excluding the OTSDUW Consents.]</p>
[Consents Works	as set out in Appendix [N]]
Construction Backstop Date	the date specified as such in the TO Construction Programme.
Construction Project	[project specific description]

[Crown Estate Lease]	<i>Edit if User to obtain this</i>
Effective Date	the date of this TO Construction Agreement.
[Embedded Transmission Counterparty]	means [] for the purposes of this TO Construction Agreement.]
[Embedded Transmission Interface Agreement]	the agreement to be entered into by the Transmission Owner and Embedded Transmission Counterparty pursuant to Clause 2.21 of this Construction Agreement and Section C Part Three Paragraph 3.4 of the Code.
[Embedded Transmission Interface Site]	the site of connection between the Offshore Transmission System and the Onshore Distribution System and set out in Appendix B.
[Embedded Transmission Interface Site Works]	as set out in Appendix [Q]
Forecast Offshore Construction Cost	the sum specified in Appendix U.
Initial Connection Site Specification	the initial draft of the Connection Site Specification attached at Appendix F and which is to be developed by the Transmission Owner in accordance with Clause 2.22 into the Connection Site Specification.
[Initial Embedded Transmission Interface Site Specification]	the initial draft of the Embedded Transmission Interface Site Specification attached at Appendix W and to be developed by the Transmission Owner pursuant to Clause 2.23 into the Embedded Transmission Interface Site Specification.
Initial Transmission Interface Site Specification	the initial draft of the Transmission Interface Site Specification attached at Appendix W and to be developed by the Transmission Owner pursuant to Clause 2.24 into the Transmission Interface Site Specification.
Initial Services Capability Specification	the initial draft of the Services Capability Specification attached at Appendix R and to be developed by the Transmission Owner pursuant to Clause 2.19 into the Services Capability Specification.

Interface Agreement	the agreement to be entered into between the Transmission Owner and the User as required pursuant to Clause 2.20 of this TO Construction Agreement and Section C Part Three Paragraph 3.1 of the Code.
Liquidated Damages	the sums specified in or calculated pursuant to Appendix K, Part One to this TO Construction Agreement.
Offshore Construction Secured Amount	the sum specified in Appendix U
[Offshore Transmission System Development User Works or OTSDUW]	[those activities to be undertaken by the User set out in Appendix I (Part 2) [preparatory to OFTO Build.]
Offshore Works Criteria	the matters set out in Appendix O.
One Off Works	as set out in Appendix L.
[Onshore Construction Works	means the works to be undertaken by any Joint Project Party [and the Embedded Transmission Counterparty] in respect of the Construction Project.]
[Onshore Distribution System	means [] for the purposes of this TO Construction Agreement.]
[Onshore Transmission Owner	means [] for the purposes of this TO Construction Agreement.]
[OTSDUW Consents]	[those: <ul style="list-style-type: none"> (a) planning and other statutory consents; (b) wayleaves, easements, rights over or interests in land or any other consents; or (c) permissions of any kind, if any, set out as such in Appendix I (Part 2).]
[Seven Year Statement Works	as set out in Appendix [M].]
Third Party Works	as set out in Appendix M.
TI Commissioning Programme	the sequence of operations/tests necessary to connect the Transmission Owners Offshore Transmission System to

	the [Onshore Transmission System at the Transmission Interface Site] [Offshore Distribution System at the Embedded Transmission Interface Site].
TI Commissioning Programme Commencement Date	the date for commencement of the TI Commissioning Programme as set out in the TO Construction Programme.
TO Commissioning Programme	the sequence of operations/tests necessary to connect the Users Works and the Transmission Connection Asset Works to the National Electricity Transmission System for the purpose of making the User's Works available for connection and operation.
TO Commissioning Programme Commencement Date	the date for commencement of the TO Commissioning Programme as set out in the TO Construction Programme.
TO Construction Programme	the programme agreed by the Transmission Owner and The Company for the carrying out of Transmission Construction Works as set out in Appendix J
TO Event of Default	those events set out in Appendix [T].
TO Liquidated Damages	the sums specified in or calculated pursuant to Appendix K, Part Two to this TO Construction Agreement
Transmission Connection Assets	as set out in Appendix A
Transmission Construction Works	the Transmission Connection Asset Works, Transmission Reinforcement Works, One Off Works and Seven Year Statement Works [(but excluding, for the avoidance of doubt, the OTSDUW)].
Transmission Interface Agreement	the agreement to be entered into by the Transmission Owner and Onshore Transmission Owner pursuant to Clause 2.21 of this Construction Agreement and Section C Part Three Paragraph 3.2 of the Code.
Transmission Interface Site	the site of connection between the Offshore Transmission System and the Onshore Transmission System and set out in Appendix B.
Transmission Interface Site Works	as set out in Appendix Q

Transmission Reinforcement Works	as set out in Appendix H
User	[]
User Data	the data in respect of the User's Plant and Apparatus as set out in Appendix P and against which the Transmission Construction Works have been designed.
User's Works	as set out in Appendix I [including the OTSDUW)].
Works	the Transmission Construction Works and User Works [and Transmission Interface Site Works] [Embedded Transmission Interface Site Works].

2. Carrying out of the Works

2.1 Forthwith following the Effective Date, the Transmission Owner shall

- (i) agree with the User the Safety Rules and Local Safety Instructions to apply during the TO Construction Programme and TO Commissioning Programme. Failing agreement within three months of the Effective Date, the matter shall be referred to the Independent Engineer for determination in accordance with Clause 5 of this TO Construction Agreement; and
- (ii) agree with [the Onshore Transmission Owner] [the Embedded Transmission Counterparty] the Safety Rules and Local Safety Instructions to apply during the TO Construction Programme and TI Commissioning Programme. Failing agreement within three months of the Effective Date, the matter shall be referred to the Independent Engineer for determination in accordance with Clause 5 of this Construction Agreement.

2.2 In relation to the Connection Site, the Transmission Owner shall, and The Company shall procure that the User shall, ensure that each other is supplied with a copy of the Safety Rules current from time to time, including any site-specific Safety Rules, and also a copy of the Local Safety Instructions applicable at each Connection Site from time to time.

2.3 In relation to the [Transmission Interface Site, [the Transmission Owner shall and NGET shall procure that the Onshore Transmission Owner shall]] [Embedded Transmission Interface Site, the Transmission Owner shall and NGET shall procure that the Embedded Transmission Counterparty shall], ensure that each other is supplied with a copy of the Safety Rules current from time to time, including any site-specific Safety Rules, and also a copy of the Local Safety Instructions applicable at the [Transmission Interface Site] [Embedded Transmission Interface Site] from time to time.

2.4 Subject to paragraphs 2.5 and 2.7 forthwith following the Effective Date, the Transmission Owner shall use its best endeavours to obtain in relation to the Transmission Construction

Works and The Company shall use its best endeavours to procure that the Onshore Transmission Owner obtains in relation to the Transmission Interface Site Works] [procure that the Embedded Transmission Counterparty obtains in relation to the Embedded Transmission Interface Site Works] [and procure that the User obtains in relation to the User Works all Consents. Each shall give advice and assistance to the other to the extent reasonably required by the other in the furtherance of these obligations. Further, each Party shall, and The Company shall procure that the User [and [Onshore Transmission Owner] [Embedded Transmission Counterparty]] shall, so far as it is legally able to do so, grant to the other, or the User, all such wayleaves, easements, servitude rights or other rights over or interests in land or any other consents reasonably required by the other or the User in order to enable the Works to be expeditiously completed and to enable that other to carry out its obligations to the other under this TO Construction Agreement and in all cases subject to such terms and conditions as are reasonable. [For the avoidance of doubt, the User has already obtained the OTSDUW Consents, and so this paragraph 2.4, and paragraphs 2.5 and 2.7, do not apply in respect of the OTSDUW Consents.]

2.5 The following additional provisions shall apply in respect of the Consents and Transmission Construction Works:

2.5.1 All dates specified in this TO Construction Agreement are subject to the Transmission Owner obtaining Consents for the Transmission Construction Works in a form acceptable to it and within the time required to carry out the Transmission Construction Works in accordance with the TO Construction Programme.

2.5.2 In the event of:

- (a) the Consents not being obtained by the required date; or
- (b) the Consents being subject to conditions which affect the dates; or
- (c) the Transmission Owner wishing to amend the Transmission Construction Works to facilitate the granting of the Consents,

the Transmission Owner shall be entitled to revise the Transmission Construction Works (and as a consequence the relevant Appendices of this TO Construction Agreement which set out such Transmission Construction Works and [any related charges]). For the avoidance of doubt such revisions shall be as agreed between the Transmission Owner and The Company and the Transmission Owner shall notify The Company in writing as soon as practicable of any change setting out the scope of changes and the reasons for the same.

2.6 The Parties shall regularly update each other in writing or by such other means as the relevant Parties may agree as to progress made by them and, in the case of The Company, as to progress made by the [User] [Onshore Transmission Owner] [Embedded Transmission Counterparty] from time to time in the obtaining of relevant Consents pursuant paragraphs 2.4 or 2.5.

2.7 The Company shall be liable to pay to the Transmission Owner:

2.7.1 all of the Transmission Owner's Engineering Charges accrued; and

2.7.2 proper and reasonable out-of-pocket expenses incurred and/or paid or which the Transmission Owner is legally bound to incur or pay,

in seeking and obtaining the Consents the subject of paragraph 2.4 excluding any costs associated with the Seven Year Statement Works and any other works, to the extent that The Company has paid or is liable to pay such costs under another TO Construction Agreement.

The Company acknowledges these out of pocket ancillary expenses may include planning inquiries or appeals and the capital costs together with reasonable legal and surveyors costs of landowners or occupiers in acquiring permanent easements or other rights in respect of any electric line or underground cable forming part of the Transmission Connection Asset Works. This sum shall not include any capital costs incurred by the Transmission Owner in the acquisition by it of the freehold of any land upon which a land charge is payable. The Transmission Owner shall keep The Company informed of the level of such charges and expenses being incurred. The Company shall pay such sums within 30 (thirty) days of the date of the Transmission Owner's invoice therefor.

2.8 Paragraphs 2.2, 2.3, 2.4 and 2.5 of Section J of the Code relating to Consents shall apply to the construction arrangements set out in this TO Construction Agreement as if set out here in full.

2.9 The Company may by written notice to the Transmission Owner terminate this TO Construction Agreement at any time whereupon The Company shall in addition to the sums for which it is liable under paragraph 2.7 [except and to the extent that TO Construction Agreement is terminated on the basis of a TO Event of Default] be liable to pay to the Transmission Owner a sum equal to the Transmission Owner's estimate or if applicable revised estimate of TO Final Sums. The Company shall pay such sums within 16 (sixteen) days of the date of the Transmission Owner's invoice(s) therefor and (where applicable) on termination the Transmission Owner shall disconnect the User's Equipment at the Connection Site and:

2.9.1 *[where the Transmission Owner is the owner of the Offshore Platform]* The Company shall procure that a User removes any of the User's Equipment on the Offshore Platform within such period as may be agreed between the Transmission Owner and the User; or

2.9.1 *[where the User is the owner of the Offshore Platform]* the Transmission Owner shall remove any of the Transmission Connection Assets on the Offshore Platform within such period as may be agreed between the Transmission Owner and the User.

2.10 The Transmission Owner shall be entitled to contract or sub-contract for the carrying out of its respective parts of the Works. The Company shall procure the commencement and

carrying out of the User Works [and Embedded Transmission Interface Site Works] to such stage of completion as shall render them capable of being Commissioned in accordance with the TO Construction Programme and the Transmission Owner or any contractor on its behalf shall be responsible for commencing and carrying out the Transmission Construction Works to such stage of completion as shall render them capable of being Commissioned in accordance with the TO Construction Programme.

2.11 The Company may, at its discretion, notify the Transmission Owner at any time in writing to discontinue, postpone or otherwise delay all or part of any Works or other activities under this TO Construction Agreement and may direct that the Transmission Owner produce an amended TO Construction Programme and/or TO Commissioning Programme and/or TI Commissioning Programme accordingly, as a consequence of:

2.11.1 a User breaching any credit or security requirement pursuant to the CUSC or CUSC Construction Agreement;

2.11.2 a delay or failure by a User or another Joint Project Party [or the Embedded Transmission Counterparty] to obtain any Consents; or

2.11.3 a delay or failure by another Joint Project Party under and pursuant to any other TO Construction Agreement in respect of the same Construction Project; or

[2.11.4 a delay or failure by the Embedded Transmission Counterparty under or pursuant to the Embedded Transmission Bilateral Agreement.]

2.12 During the period of and at the times and otherwise as provided in the TO Construction Programme and the TO Commissioning Programme the Transmission Owner shall allow the User and in either case their employees, agents, suppliers, contractors and subcontractors and The Company shall ensure that the User allows (in relation to its sites) the Transmission Owner, its employees, agents, suppliers, contractors and subcontractors, necessary access to [the Offshore Platform] to enable each to carry out the Transmission Connection Asset Works and One Off Works or User Works but not so as to disrupt or delay the construction and completion of the other's Works on the said [Offshore Platform] or the operation of any other's Plant and Apparatus located thereon, such access to be in accordance with any reasonable regulations relating thereto made by the site owner or occupier.

2.13 During the period of and at the times and otherwise as provided in the TO Construction Programme and the TI Commissioning Programme the Transmission Owner shall allow [the Onshore Transmission Owner] [the Embedded Transmission Counterparty] and their employees, agents, suppliers, contractors and subcontractors and NGET shall [ensure that the [Onshore Transmission Owner] [Embedded Transmission Counterparty] allows] the Transmission Owner, its employees, agents, suppliers, contractors and subcontractors, necessary access to the [[Transmission Interface Site] [Embedded Transmission Interface Site]] to enable each to carry out the Transmission Connection Asset Works and One Off Works or [[Transmission Interface Site Works] [Embedded Transmission Interface Site Works]] but not so as to disrupt or delay the construction and completion of the other's Works on the said [[Transmission Interface Site] [Embedded

Transmission Interface Site]] or the operation of any other's Plant and Apparatus located thereon, such access to be in accordance with any reasonable regulations relating thereto made by the site owner or occupier.

2.14 Not later than six months prior to

- (i) the TO Commissioning Programme Commencement Date, the Transmission Owner shall provide The Company with a draft TO Commissioning Programme for the Commissioning of the Transmission Connection Assets, and the User's Equipment. The Company shall, as quickly as practicable and in any event within three months of receipt thereof, determine whether or not to approve the proposed TO Commissioning Programme (which approval shall not be unreasonably withheld or delayed) and shall within such three month period either notify the Transmission Owner of its approval or, in the event that The Company reasonably withholds its approval, notify the Transmission Owner of any changes or variations to the proposed commissioning programme recommended by The Company. If the Transmission Owner does not accept such changes or variation submitted by The Company any dispute shall be referred to the Independent Engineer for determination. The TO Commissioning Programme agreed between the parties or determined by the Independent Engineer as the case may be shall be implemented by the parties and their sub-contractors in accordance with its terms.
- (ii) the TI Commissioning Programme Commencement Date, the Transmission Owner shall provide the Onshore Transmission Owner with a draft TI Commissioning Programme for the Commissioning of the Transmission Owner's Plant and Apparatus to the [[Onshore Transmission System at the Transmission Interface Site] [Onshore Distribution System at the Embedded Transmission Interface Site]]. . [The Company shall procure that, as quickly as practicable and in any event within three months of receipt thereof, the [[Onshore Transmission Owner] [Embedded Transmission Counterparty] determines whether or not to approve the proposed TI Commissioning Programme and shall within such three month period either notify the Transmission Owner of the [[Onshore Transmission Owners] [Embedded Transmission Counterpartys] approval or, in the event that the [[Onshore Transmission Owner reasonably withholds its approval] [Embedded Transmission Counterparty withholds its approval], notify the Transmission Owner of any changes or variations to the proposed commissioning programme recommended by The Company] If the Transmission Owner does not accept such changes or variation submitted by The Company any dispute shall be referred to the Independent Engineer for determination. The TI Commissioning Programme agreed between the parties or determined by the Independent Engineer as the case may be shall be implemented by the parties and their sub-contractors in accordance with its terms.

2.15 If at any time prior to the Completion Date there is a) a change to the Offshore Works Criteria and/or User Data and it is or the Transmission Owner becomes aware that it may be necessary for the Transmission Owner to make any addition to or omission from or amendment to or b) there is no change to the Offshore Works Criteria and/or User Data

but the Transmission Owner in its reasonable discretion wishes to make any addition to or omission from or amendment to its Transmission Connection Asset Works and/or Transmission Reinforcement Works and/or the One Off Works and/or the Third Party Works the Transmission Owner shall as soon as practicable notify The Company in writing of such addition, omission or amendment citing the reasons for the same [and any implications for the TO Construction Programme and/or [costs] and where the parties so agree the relevant Appendices of this TO Construction Agreement shall be automatically amended to reflect the change.

2.16 The Transmission Reinforcement Works are conditional on any relevant nuclear generator granting approval to the carrying out of the Transmission Construction Works in terms of any Nuclear Site Licence Provisions Agreement. In the event of the relevant nuclear generator not granting approval the Transmission Owner shall be entitled to change the Transmission Construction Works, the TO Construction Programme and all dates specified in this TO Construction Agreement.

2.17 It is hereby agreed and declared for the purposes of the Construction (Design and Management) Regulations 2015 that the Transmission Owner is the only client in respect of the Transmission Construction Works and shall accordingly discharge all the duties of a client under the said Regulations.

2.18 The Transmission Owner and The Company hereby agree and acknowledge that this TO Construction Agreement is not to be treated as a construction contract within the meaning of section 104 of the Housing Grants, Construction and Re-generation Act 1996 and sections 104 to 113 of the said Act shall have no application to any part of the Transmission Construction Works and the Parties' rights and obligations with regard to matters of dispute resolution and payment procedures are as expressly set out herein.

2.19 Services Capability Specification

The Initial Services Capability Specification shall be developed and amended by the parties by agreement as the design of the Transmission Construction Works is finalised such that the parties can agree the Services Capability Specification by the date specified in the Construction Programme or by such other date as the parties shall agree.

2.20 Interface Agreement

Not later than 6 months prior to the Completion Date or such other period as the Transmission Owner and the User shall agree the Transmission Owner shall enter into the Interface Agreement with the User.

2.21 Transmission Interface Agreement/Embedded Transmission Interface Agreement

By not later than 6 months prior to the Completion Date or such other period as the Transmission Owner and [the Onshore Transmission Owner] [the Embedded Transmission Counterparty] shall agree the Transmission Owner and [the Offshore

Transmission Owner] [Embedded Transmission Counterparty] shall enter into the [Transmission Interface Agreement] [Embedded Transmission Interface Agreement].

2.22 Connection Site Specification

The Initial Connection Site Specification shall be developed and amended by the parties by agreement as the design of the Transmission Construction Works is finalised such that the parties can agree the Connection Site Specification not later than the date specified in the Construction Programme or by such other date as the parties shall agree such that it is available as required by Section D Part Two Paragraph 14 of the Code.

2.23 Embedded Transmission Interface Site Specification

The Initial Embedded Transmission Interface Site Specification shall be developed and amended by the parties by agreement as the design of the Transmission Construction Works is finalised such that the parties can agree the Embedded Transmission Interface Site Specification not later than the date specified in the Construction Programme or by such other date as the parties shall agree such that it is available as required by Section D Part Two Paragraph 14 of the Code and in sufficient time for The Company to finalise any similar arrangements under the Embedded Transmission Bilateral Agreement.

2.24 Transmission Interface Site Specification

The Initial Transmission Interface Site Specification shall be developed and amended by the parties by agreement as the design of the Transmission Construction Works is finalised such that the parties can agree the Transmission Interface Site Specification not later than the date specified in the Construction Programme or by such other date as the parties shall agree such that it is available as required by Section D Part Two Paragraph 14 of the Code.

2.25 Notice of Readiness

In addition to its obligations under Section D Part Two Paragraph 9 of the Code the Transmission Owner shall give notice to The Company:

- 25.1 not less than [] prior to placing any material contracts for the Transmission Construction Works and shall agree by the date specified for such in the Construction programme those contracts which are to be considered material; and
- 25.2 when it is ready to commence the Transmission Construction Works,

and shall not place such contract and/or commence the Transmission Construction Works without confirmation from The Company, given the status on the programmes for the Onshore Construction Works, that it may do so.

[2.26. Embedded Transmission

2.26.1 The Transmission Owner recognises that The Company will have to enter into the Embedded Transmission Bilateral Agreement and will provide such information and assistance as The Company shall require in this respect.

2.26.2 In the event that the Embedded Transmission Counterparty proposes changes to the Embedded Transmission Interface Site Works The Company shall notify the Transmission Owner as soon as practicable and the Transmission Owner shall advise The Company of any implications for the TO Construction Programme and/or [costs] and where the parties so agree the relevant Appendices of this Construction Agreement shall be automatically amended to reflect the change]

3. **DELAYS**

3.1 If either Party shall have reason to believe that it, another Transmission Owner or, in the case of The Company a User [or the Embedded Transmission Counterparty], is being delayed or will be delayed in carrying out that Party's or a User's Works [or the Embedded Transmission Interface Site Works] (as appropriate) for any reason (whether it is one entitling it to the fixing of a new date under paragraph 3.2 of this TO Construction Agreement or not) it shall forthwith notify the other Party in writing of the circumstances giving rise to the delay and of the extent of the actual and/or anticipated delay.

3.2 If prior to the Completion Date a Party (in this paragraph 3.2 the "**Affected Party**") shall be delayed in carrying out any of the Affected Party's Works (including their commissioning) by reason of (a) any act, default or omission on the part of the other Party (in this paragraph the "**Defaulting Party**") or of the Defaulting Party's employees, agents, contractors, sub-contractors or, in the case where The Company is the Defaulting Party, by reason of a delay by the User or (b) any act, default or omission on the part of any Transmission Owner which is not a Party to this TO Construction Agreement or its employees, agents, contractors or subcontractors or (c) by reason of an event of Force Majeure [or (d) any act, default or omission on the part of the Embedded Transmission Counterparty or its employees, agents, contractors or subcontractors], the Affected Party shall be entitled to have such later date or dates fixed as the TO Commissioning Programme Commencement Date and/or (as the case may be) TI Commissioning Programme Commencement Date and/or (as the case may be the Completion Date as may be fair and reasonable in the circumstances provided that it shall have notified the Defaulting Party in writing of such act, default or omission or event of Force Majeure within 28 days of it becoming aware of the occurrence giving rise to the delay together with an estimate of the proposed delay which it will cause the Affected Party. In the event of a dispute between the parties over what is or are any fair and reasonable date or dates to be fixed in the circumstance this shall be promptly referred to and determined by the Independent Engineer. Once the new date or dates are fixed the TO Construction

Programme and/or TO Commissioning Programme and/or TI Commissioning Programme shall be deemed automatically amended as appropriate.

4. COMMISSIONING PROGRAMME AND LIQUIDATED DAMAGES

- 4.1 Each Party shall give written notice to the other declaring its readiness to commence the Commissioning Programme when this is the case.
- 4.2 The Commissioning Programme shall commence forthwith once both Parties shall have given written notice to the other under paragraph 4.1.
- 4.3 The Transmission Construction Works and [Transmission Interface Site Works] [Embedded Transmission Interface Site Works] shall be deemed to have been Commissioned on the date agreed by the parties or if not agreed on the date that the Independent Engineer certifies in writing to that effect.
- 4.4 In the event that the actual date of commencement of the TO Commissioning Programme shall be later than the TO Commissioning Programme Commencement Date the Transmission Owner (if and to the extent that it is responsible for delayed commissioning beyond the TO Commissioning Programme Commencement Date, such responsibility and/or its extent to be determined by the Independent Engineer failing agreement between the parties) shall be liable to pay to The Company Liquidated Damages for each day that the actual date of commencement of the TO Commissioning Programme is later than the TO Commissioning Programme Commencement Date. It is declared and agreed that such Liquidated Damages shall cease to be payable in respect of any period after the date of actual commencement of the TO Commissioning Programme.
- [4.5 In the event that the actual date of commencement of the TI Commissioning Programme shall be later than the TI Commissioning Programme Commencement Date the Transmission Owner (if and to the extent that it is responsible for delayed commissioning beyond the TI Commissioning Programme Commencement Date, such responsibility and/or its extent to be determined by the Independent Engineer failing agreement between the parties) shall be liable to pay to The Company Liquidated Damages for each day that the actual date of commencement of the TI Commissioning Programme is later than the TI Commissioning Programme Commencement Date. It is declared and agreed that such Liquidated Damages shall cease to be payable in respect of any period after the date of actual commencement of the TI Commissioning Programme.]
- 4.6 In the event that the actual date on which the Transmission Construction Works are Commissioned is later than the Completion Date the Transmission Owner (if and to the extent that it is responsible for delayed completion beyond the Completion Date, such responsibility and/or its extent to be determined by the Independent Engineer failing agreement between the Parties) shall be liable to pay to The Company Liquidated Damages for each day that the actual date on which the Transmission Construction Works are Commissioned is later than the Completion Date. It is hereby agreed and

declared that such Liquidated Damages shall cease to be payable in respect of any period after completion of the Transmission Construction Works.

- 4.7 In the event that the actual date on which the Transmission Construction Works are Commissioned is later than the Completion Date (if and to the extent that the Transmission Owner is not responsible for delayed completion beyond the Completion Date, such responsibility and/or its extent to be determined by the Independent Engineer failing agreement between the Parties) The Company shall be liable to pay to the Transmission Owner TO Liquidated Damages for each day that the actual date on which the Transmission Construction Works are Commissioned is later than the Completion Date. It is hereby agreed and declared that such TO Liquidated Damages shall cease to be payable in respect of any period after completion of the Transmission Construction Works. The Company's liability for TO Liquidated Damages shall be limited to £1million.
- 4.8 Liquidated Damages payable under paragraphs 4.4[4.5] and 4.6 and TO Liquidated Damages payable under paragraph 4.7 shall accumulate on a daily basis but shall be payable calendar monthly. On or before the 13th day of each month the Party entitled to receive the payment of Liquidated Damages shall send to the other Party a statement of the Liquidated Damages which have accrued due in the previous calendar month. The Party receiving such statement shall in the absence of manifest error pay the Liquidated Damages shown on the statement within 28 days of the date upon which the statement is received.
- 4.9 Without prejudice to and in addition to the obligation of The Company pursuant to paragraph 2.6 the payment or allowance of Liquidated Damages pursuant to this paragraph 4 shall be in full satisfaction of the Transmission Owner's liability for failure to perform its obligations by the TO Commissioning Programme Commencement Date and/or TI Commissioning Programme Commencement Date and/or the Completion Date as appropriate.
- 4.10 In the event that The Company or a User shall have failed, in circumstances not entitling The Company to the fixing of a new date as the TO Commissioning Programme Commencement Date pursuant to paragraph 3.2, to procure that the User complete the User Works [or the Embedded Transmission Counterparty completes the Embedded Transmission Interface Site Works] by the Construction Backstop Date to a stage where such User [or such Embedded Transmission Counterparty] (as appropriate) is ready to commence the TO Commissioning Programme, the Transmission Owner shall have the right to terminate this TO Construction Agreement upon giving notice in writing to The Company. In the event of such termination The Company shall in addition to the amounts for which it is liable under paragraph 2.7, also be liable to the Transmission Owner to pay a sum equal to the Transmission Owner's estimate or revised estimate of TO Final Sums. The Company shall pay such sums within 14 (fourteen) days of the date of the Transmission Owner's invoice(s) therefor and on termination (where applicable) The Transmission Owner shall disconnect the User Equipment at the Connection Site and
- (a) *[where the offshore platform is owned by the transmission owner]* NGET shall ensure that the User shall remove any of the User Equipment on the Offshore

Platform within such period as may be agreed between the Transmission Owner and the User and

- (b) [*where the offshore platform is owned by the user*] the Transmission Owner shall remove any Transmission Connection Assets on the Offshore Platform within such period as may be agreed between the Transmission Owner and the User.

5. INDEPENDENT ENGINEER

In relation to matters raised pursuant to this TO Construction Agreement, the Parties agree and shall procure that the Independent Engineer shall act as an expert and not as an arbitrator and shall decide those matters referred or reserved to them under this TO Construction Agreement by reference to Good Industry Practice using their skill, experience and knowledge and with regard to such other matters as the Independent Engineer in their sole discretion considers appropriate. All references to the Independent Engineer shall be made in writing by either Party with notice to the other being given contemporaneously as soon as reasonably practicable and in any event within 16 days of the occurrence of the dispute to be referred to the Independent Engineer. The Parties shall promptly supply the Independent Engineer with such documents and information as they may request when considering such question. The Independent Engineer shall use their best endeavours to give their decision upon the question before them as soon as possible following its referral to them. The Parties shall share equally the fees and expenses of the Independent Engineer. The Parties expressly acknowledge that submission of disputes for resolution by the Independent Engineer does not preclude subsequent submission of disputes for resolution by arbitration as provided in Section H of the Code. Pending any such submission the parties shall treat the Independent Engineer's decision as final and binding.

6. GETTING CONNECTED AND BECOMING OPERATIONAL

6.1 Without prejudice to Paragraph 5 and subject to the provisions of this TO Construction Agreement, the Transmission Owner shall assist The Company in Connecting and Energising the User Equipment at the Connection Site including by:

- (a) completing any Transmission Construction Works required to be completed by the Transmission Owner at the times and in such manner as set out in the TO Construction Programme; and
- (b) completing any operations, tests or other activities required to be completed by the Transmission Owner at the times and in such manner as set out in the TO Commissioning Programme and/or TI Commissioning Programme.

6.2 Not later than three months prior to the expected TI Commissioning Programme Commencement Date or such other period as may be agreed the Transmission Owner shall submit to the Onshore Transmission Owner a statement of readiness to complete the TI Commissioning Programme and the Completion Report.

6.3 Subject to Clause 6.2 The Company shall procure that the Onshore Transmission Owner shall connect the Transmission Owner's Plant and Apparatus to the Onshore Transmission System at the Transmission Interface Site during the course of and in accordance with the TI Commissioning Programme and thereafter to remain so connected as part of the National Electricity Transmission System and subject to the terms of the Transmission Interface Agreement, Transmission Interface Site Specification and the Code.

[6.4 Subject to Clause 6.2 The Company shall procure that the Embedded Transmission Counterparty shall connect the Transmission Owner's Plant and Apparatus to the Onshore Distribution System at the Embedded Transmission Interface Site during the course of and in accordance with the TI Commissioning Programme and thereafter to remain so connected and subject to the terms of the Embedded Transmission Interface Agreement, Embedded Transmission Interface Site Specification and the Code and the Distribution Code.]

7. TO FINAL SUMS

7.1 Within 58 days of the date of termination of this TO Construction Agreement the Transmission Owner shall:

- (a) furnish The Company with a further statement showing a revised estimate of TO Final Sums and will provide as soon as practicable evidence of such costs having been incurred; and
- (b) by written notice to The Company inform The Company of all capital items which cost the Transmission Owner in excess of £10,000 and in relation to which an amount on account of TO Final Sums shall have been paid and whether the Transmission Owner (1) wishes to retain the said capital items or (2) dispose of them.

7.2 In respect of all capital items which the Transmission Owner wishes to retain (other than those which have been, or are proposed to be installed as a replacement for Transmission Plant and Transmission Apparatus) the Transmission Owner shall forthwith reimburse to The Company the amount paid by The Company on account of TO Final Sums in respect of the said capital items (including without limitation the amount paid on account of the design, purchase, installation and testing of the said capital item and also associated construction works and interest charges) together with interest calculated thereon on a daily basis from the date of termination of this TO Construction Agreement to the date of payment at Base Rate for the time being and from time to time provided that in the event that the Transmission Owner wishes to retain any capital item which has been installed but wishes to remove it to storage or to another site then it shall only reimburse to The Company the cost of the capital item and not the costs of such installation and shall deduct from any reimbursement due to The Company the costs of removal and/or storage.

7.3 In respect of all capital items which the Transmission Owner wishes to dispose (other than those which have been, or are proposed to be installed as a replacement for

Transmission Plant and Transmission Apparatus) it shall forthwith (and subject to the Transmission Owner obtaining the consent of the Authority under its Transmission Licence if required) sell or procure the sale of the said capital item on an arms-length basis as soon as reasonably practicable. Forthwith upon receipt of the sale proceeds the Transmission Owner shall pay to The Company the proceeds received from any such sale together with interest thereon calculated on a daily basis from the date of termination to the date of payment at Base Rate for the time being and from time to time less any reasonable costs associated with the sale including the costs and expenses reasonably incurred and/or paid and/or which the Transmission Owner is legally bound to pay on removing the capital item, any storage charges and any costs reasonably incurred by the Transmission Owner in respect of reinstatement associated with removal of the capital item. The Transmission Owner shall provide The Company with reasonably sufficient evidence of all such costs and expenses having been incurred. If the Authority does not agree to the disposal of the capital item the capital item shall be retained by the Transmission Owner and the Transmission Owner shall reimburse The Company the notional current market value in situ of the said capital item as between a willing buyer and a willing seller as agreed between the Parties and failing agreement as determined pursuant to Section H of the Code together with interest thereon calculated on a daily basis from the date of termination of this TO Construction Agreement to the date of payment at Base Rate for the time being and from time to time.

7.4 As soon as reasonably practicable after termination of this TO Construction Agreement the Transmission Owner shall provide The Company with a statement of and invoice for the TO Final Sums together with evidence of such costs having been incurred and/or paid and/or having been committed to be incurred. If the TO Final Sums are greater than the payments made by The Company in respect of the Transmission Owner's estimate(s) of TO Final Sums The Company shall within 35 days of the said statement and invoice prepared by the Transmission Owner pay to the Transmission Owner the additional payments due by The Company together with interest calculated thereon on a daily basis at Base Rate for the time being and from time to time from the date of previous payment(s) sums equal to the Transmission Owner's estimate of TO Final Sums to the date of the statement of and invoice for TO Final Sums. If the TO Final Sums is less than the payments made by The Company in respect of the Transmission Owner's estimate of TO Final Sums paid by The Company following termination of this TO Construction Agreement the Transmission Owner shall forthwith pay to The Company the excess paid together with interest on a daily basis at the Base Rate for the time being and from time to time from the date of payment of the fair and reasonable estimate of TO Final Sums to the date of reimbursement by the Transmission Owner of the said excess paid.

7.5 **Provision of Bi-annual Estimate**

The Transmission Owner shall provide to The Company an estimate ("the **Bi-annual Estimate**") in substantially the form set out in the relevant Appendix to this TO Construction Agreement and showing the amounts of all payments required or which may be required to be made by The Company to the Transmission Owner in respect of TO Final Sums and Engineering Charges and other expenses in relation to seeking Consents referred to in paragraph 2.4 at the following times and in respect of the following periods:-

- (a) forthwith and on and with effect from the Effective Date, in respect of the period from the Effective Date until the next following 31st March or 30th September (whichever shall first occur); and
- (b) not less than 82 (eighty-two) days (or if such day is not a Business Day the next following Business Day) prior to each 31st March and 30th September thereafter in respect of the period of six calendar months commencing on the immediately following 1st April or 1st October (as the case may be), until this TO Construction Agreement shall be terminated or shall expire in accordance with paragraph 8.

The Transmission Owner shall provide The Company with all advice and assistance reasonably requested by The Company in relation to any discussions or correspondence with a User in connection with Bi-annual Estimates.

7.6 **Entitlement to Estimate**

If the Transmission Owner is (for whatever reason) unable on any relevant date to calculate precisely any sum due or which has accrued due or in respect of which The Company has a liability to the Transmission Owner for payment under any of the provisions of this TO Construction Agreement, the Transmission Owner shall be entitled to invoice The Company for a sum equal to the Transmission Owner's fair and reasonable estimate of the sums due or which may become due or in respect of which The Company has a liability to the Transmission Owner for payment. The Transmission Owner shall also be entitled to send The Company further invoices for such sums not covered in previous invoices. The Company shall pay the Transmission Owner all sums so invoiced by the Transmission Owner.

8. **TERM**

8.1 Subject to the provisions for earlier termination set out in the Code, this TO Construction Agreement shall continue in force unless and until terminated in accordance with paragraphs 2.9, or 4.9.

8.2 Any provisions for payment survive the termination of this TO Construction Agreement.

9. **THE CODE**

9.1 The provisions of:

9.1.1 Section E (Payment);

9.1.2 Section F (Confidentiality);

9.1.3 Section G, paragraphs 5 (Third Party Rights), 6 (Transfer and Sub-contracting), 7 (Intellectual Property), 8 (Force Majeure), 9 (Privilege), 10 (Waiver), 11 (Nominated Representative), 12 (Communications), 13 (Counterparts), 14 (Severance of Terms), 15 (Language), 16 (Data Protection Act), 17 (Jurisdiction), 18 (Governing Law), 19 (No Partnership)

of the Code shall apply to this TO Construction Agreement as if set out in this TO Construction Agreement in full.

10. DISPUTES AND TO EVENT OF DEFAULT

- 10.1 Except as specifically provided for in this TO Construction Agreement any dispute arising under the terms of this TO Construction Agreement shall be referred to arbitration in accordance with the terms of Section H of the Code.
- 10.2 In the event that this TO Construction Agreement is terminated by The Company as a result of a TO Event of Default then the Transmission Owner shall be liable to pay to The Company the [Offshore Construction Secured Amount] such payment to be made by the Transmission Owner to The Company within 14 days of the date of The Company's invoice therefor.
- 10.3 In the event of a TO Event of Default, The Company shall be entitled to issue Notices of Drawing against the Offshore Construction Secured Amount as are necessary to recover:
- 10.3.1 any unpaid Liquidated Damages payment due from the Transmission Owner in accordance with Clause 4.8 and
- 10.3.2 any Replacement Offshore Transmission Owner Charges due to The Company in accordance with Section E of the Code.

11. VARIATIONS

- 11.1 Subject to paragraphs 11.2 and 11.3 below, no variation to this TO Construction Agreement shall be effective unless made in writing and signed by or on behalf of both the Transmission Owner and The Company.
- 11.2 The Transmission Owner and The Company shall effect any amendment required to be made to this TO Construction Agreement by the Authority as a result of a change in the Code or a Licence or an order or direction made pursuant to the Act or a Licence. The Company hereby authorises and instructs the Transmission Owner to make any such amendments on its behalf and undertakes not to withdraw, qualify or revoke such authority or instruction at any time.
- 11.3 [The Transmission Owner has the right to vary any Appendices to this TO Construction Agreement in accordance with paragraphs 2.5, 2.15 and 3.2].

12. ATTRIBUTABLE WORKS

- 12.1 The Transmission Owner shall provide to The Company (in a form agreed between the Transmission Owner and The Company) the following information at the following times (or such other times as agreed between the Transmission Owner and The Company):-

- (a) by reference to each component of the Attributable Works, forthwith on the Effective Date and then not less than 82 (eighty-two) days (or if such day is not a Business Day the next following Business Day) prior to each 31st March and 30th September thereafter (until this TO Construction Agreement shall be terminated or shall expire in accordance with paragraph 8 or until The Company notifies the Transmission Owner that it is no longer required):
 - (i) an estimate of the Attributable Works Capital Cost;
 - (ii) an estimate of capability in MW;
 - (iii) an assessment of the actual or potential for reuse and any strategic benefits provided as a percentage of the estimate provided at (i); and
- (b) by reference to each component of the Attributable Works, forthwith and on and with effect from the Effective Date, in respect of the period from the Effective Date until the next following 31st March or 30th September (whichever shall first occur) an estimate of the Attributable Works Capital Cost; and
- (c) by reference to each component of the Attributable Works, not less than 82 (eighty-two) days (or if such day is not a Business Day the next following Business Day) prior to each 31st March and 30th September thereafter in respect of the period of six calendar months commencing on the immediately following 1st April or 1st October (as the case may be) (until this TO Construction Agreement shall be terminated or shall expire in accordance with paragraph 8 or until The Company notifies the Transmission Owner that it is no longer required), an estimate of the Attributable Works Capital Cost.

12.2 On termination of this TO Construction Agreement and where requested by The Company to do so the Transmission Owner shall together with the statements and information provided to The Company by the Transmission Owner pursuant to paragraphs 7.1 to 7.5 in respect of the TO Final Sums, provide statements and information in a form as agreed between the Transmission Owner and The Company in respect of the amount within the TO Final Sums which represents the Actual Attributable Works Capital Cost of each component within the Attributable Works and also a justification of and supporting information in respect of the Transmission Owners assessment of the actual or potential for reuse and any strategic benefits of the Attributable Works and any of the resulting assets.

12.3 The Transmission Owner shall provide The Company with all advice and assistance and information reasonably requested by The Company in relation to any discussions or correspondence with a User in connection with the Attributable Works Capital Cost and assessment of the actual or potential for reuse and any strategic benefits of the Attributable Works and any of the resulting assets including the calculation and/or estimation of the same.

IN WITNESS WHEREOF the hands of the duly authorised representatives of the parties hereto at the date first above written

SIGNED BY)

[name])

for and on behalf of)

National Grid Electricity System Operator Limited)

SIGNED BY)

[name])

for and on behalf of)

[Transmission Owner])

APPENDIX A

CONNECTION SITE AND TRANSMISSION CONNECTION ASSETS

APPENDIX B

TRANSMISSION INTERFACE SITE

APPENDIX C

CONNECTION SITE – SITE SPECIFIC TECHNICAL REQUIREMENTS

[requirements to be provided by OFTO for User]

APPENDIX D

TRANSMISSION INTERFACE SITE/EMBEDDED TRANSMISSION INTERFACE SITE – SITE SPECIFIC TECHNICAL DESIGN AND OPERATIONAL REQUIREMENTS

[requirements to be provided by TO for OFTO]

APPENDIX E

TRANSMISSION INTERFACE SITE SPECIFICATION/EMBEDDED TRANSMISSION INTERFACE SITE SPECIFICATION

[draft to be attached]

APPENDIX F

CONNECTION SITE SPECIFICATION

[draft to be attached]

APPENDIX G
TRANSMISSION CONNECTION ASSET WORKS

APPENDIX H
TRANSMISSION REINFORCEMENT WORKS

APPENDIX I
USER WORKS

APPENDIX J
CONSTRUCTION PROGRAMME

APPENDIX K
LIQUIDATED DAMAGES

[Part One- Payable by Transmission Owner

Part Two - Payable by The Company]

APPENDIX L
ONE OFF WORKS

APPENDIX M

SEVEN YEAR STATEMENT WORKS and ONE OFF WORKS

APPENDIX N

CONSENTS WORKS

APPENDIX O

OFFSHORE WORKS CRITERIA

[List Agreed Criteria Following Tender Including Technical Specification Of Users Equipment, Technical specification of OFTO's plant at transmission interface site and connection site, Site Specific Technical Conditions, Derogations, ownership boundary at connection site and transmission interface site]

APPENDIX P

USER DATA

[CEC and TEC, number, type, rating of machines, including reactive capability]

APPENDIX Q

TRANSMISSION INTERFACE SITE WORKS/EMBEDDED TRANSMISSION INTERFACE SITE

[local works if any required to connect OFTO at Transmission Interface Site/Embedded Transmission Interface Site]

APPENDIX R

INITIAL SERVICES CAPABILITY SPECIFICATION

[Draft to be provided]

APPENDIX S

MATTERS FOR COMPLETION REPORT

[List matters to be included which shall contain

- Confirmation of Compliance Statement;
- type test results\reports;
- confirmation that the signed CUSC Interface Agreement(s) are in place;
- confirmation that the signed Transmission Interface Agreement/Embedded Transmission Interface Agreement is in place;
- confirmation that the signed Transmission Interface Site Specification/Embedded Transmission Site Specification is in place;
- confirmation that the Services Capability Specification is in place;
- confirmation that Safety Rules have been exchanged;
- confirmation that the Connection Site Specification(s) are complete and in place; and,
- confirmation that the Site Responsibility Schedule is complete and in place.]

APPENDIX T

TO Event of Default

[Circumstances in which The Company terminates and OFTO security can be called upon]

APPENDIX U

**TRANSMISSION OWNER [CHARGES\COSTS] [and FORECAST OFFSHORE
CONSTRUCTION COST and OFFSHORE CONSTRUCTION SECURED AMOUNT]**

[charges for The Company\pass on to USER]

[amount to be secured by TO]

APPENDIX V

FORM OF BI-ANNUNAL ESTIMATE

[for purposes of clause 7]

APPENDIX W

**TRANSMISSION INTERFACE SITE SPECIFICATION/EMBEDDED TRANSMISSION
INTERFACE SITE SPECIFICATION**

[draft to be provided]

APPENDIX X

ATTRIBUTABLE WORKS

SCHEDULE TEN

CHARGES

PART ONE: TO GENERAL SYSTEM CHARGES

In relation to each Transmission Owner, as set out and specified in, and determined in accordance with the statement prepared in accordance with Special Condition J2 of that Transmission Owner's transmission licence and approved by the Authority.

PART TWO: TO SITE-SPECIFIC CHARGES

In relation to each Transmission Owner, as set out and specified in, and determined in accordance with the statement prepared in accordance with Special Condition J2 of that Transmission Owner's transmission licence and approved by the Authority.

PART THREE: OTHER CHARGES

In relation to each Transmission Owner, as set out and specified in, and determined in accordance with the statement prepared in accordance with Special Condition J2 of that Transmission Owner's transmission licence and approved by the Authority.

PART FOUR: INTERRUPTION CHARGES

In relation to a Transmission Owner, the Interruption Payment determined by The Company in accordance with the provisions of the CUSC which is payable to a User in respect of a Relevant Interruption which is solely as a result of the De-energisation of such Transmission Owner's Plant and Apparatus. An Offshore Transmission Owner's total liability for Interruption Charges and Offshore Compensation Payments in any year, shall not exceed the restriction of transmission revenue defined by Special Condition J4 of that Offshore Transmission Owner's transmission licence.

PART FIVE: OFFSHORE TRANSMISSION OWNER OF LAST RESORT CHARGES

In relation to each Transmission Owner, as set out and specified in a direction issued by the Authority to that Transmission Owner in accordance with Standard Condition B18 or E21 of the transmission licence.

PART SIX: OFFSHORE CONSTRUCTION SECURITIES

In relation to a Transmission Owner, the Offshore Construction Securities determined by The Company in accordance with Section D Part Two Paragraph 8 of this Code.

PART SEVEN: OFFSHORE COMPENSATION PAYMENTS

In relation to an Offshore Transmission Owner, the Interruption Payment determined by The Company in accordance with the CUSC which is payable to a User in respect of an Interruption (other than a Relevant Interruption), which is solely as a result of the de-energisation of such Offshore Transmission Owner's Plant and Apparatus, where that Offshore Transmission Owner has not met the transmission system availability target defined in Special Condition C4 of that Offshore Transmission Owner's transmission licence. An Offshore Transmission Owner's total liability for Interruption Charges and Offshore Compensation Payments in any year, shall not

exceed the restriction of transmission revenue defined by Special Condition J4 of that Offshore Transmission Owner's transmission licence.

PART EIGHT: REPLACEMENT OFFSHORE TRANSMISSION OWNER CHARGES

In relation to an Offshore Transmission Owner where The Company is entitled to draw on the Offshore Construction Securities, the Replacement Offshore Transmission Owner Charges incurred by The Company as a consequence of any event of Offshore Transmission Owner default that leads to termination of a TO Construction Agreement.

SCHEDULE ELEVEN

THE COMPANY TEC EXCHANGE RATE APPLICATIONS

- 1 REQUIREMENTS FOR THE COMPANY TEC EXCHANGE RATE APPLICATION SUBMITTED BY THE COMPANY TO A TRANSMISSION OWNER PURSUANT TO SECTION D, PART THREE, SUB-PARAGRAPH 1.1.1, 1.1.2 OR 1.1.3:**
- 1.1 The Company TEC Exchange Rate Application submitted by The Company to a Transmission Owner pursuant to Section D, Part Three, sub-paragraph 1.1.1, 1.1.2 or 1.1.3 shall contain the following information:
 - 1.1.1 The User Application Date.
 - 1.1.2 The MW increase in Transmission Entry Capacity at the Connection Site of the Increasing User contained within the Exchange Rate Request.
 - 1.1.3 The MW decrease in Transmission Entry Capacity at the Connection Site of the Decreasing User contained within the Exchange Rate Request
 - 1.1.4 Where the Transmission System of the Transmission Owner is located at the Relevant Connection Site of the Increasing User or where the Transmission System of the Transmission Owner satisfies the criteria set out in Schedule Four for the Relevant Connection Site of the Increasing User:
 - 1.1.4.1 the Connection Site for the Increasing User; otherwise,
 - 1.1.4.2 the name of the Party within whose Transmission System the Connection Site of the Increasing User is located.
 - 1.1.5 Where the Transmission System of the Transmission Owner is located at the Relevant Connection Site of the Decreasing User or where the Transmission System of the Transmission Owner satisfies the criteria set out in Schedule Four for the Relevant Connection Site of the Decreasing User:
 - 1.1.5.1 The Connection Site for the Decreasing User; otherwise,
 - 1.1.5.2 the name of the Party within whose Transmission System the Connection Site of the Decreasing User is located.
 - 1.1.6 The date on which The Company wishes The Company TEC Exchange Rate Request to be effective.
 - 1.1.7 The Company TEC Exchange Rate Application reference number.

SCHEDULE TWELVE

Transmission Owner TEC EXCHANGE RATES

The Company TEC Exchange Rate Application reference number:

Connection Site of Increasing User (where previously notified to the Transmission Owner by The Company):

Connection Site of Decreasing User (where previously notified to the Transmission Owner by The Company):

Increase in Transmission Entry Capacity that may be accommodated at the Connection Site of the Increasing User given corresponding decrease in Transmission Entry Capacity at the Connection Site of the Decreasing User:

SCHEDULE THIRTEEN

THE COMPANY REQUESTS FOR STATEMENTS OF WORKS

1. Requirements for The Company Request for a Statement of Works submitted by The Company to a Transmission Owner pursuant to Section D, Part Four, sub-paragraph 1.1.1:

1.1 The Company Request for a Statement of Works submitted by The Company to a Transmission Owner pursuant to Section D, Part Four, sub-paragraph 1.1.1 shall contain the following information:

1.1.1 The User Application Date.

1.1.2 The name of the Connection Site.

1.1.3 Standard Planning Data.

1.1.4 The capacity of the Power Station connecting to the User's Distribution System.

1.1.5 The date on which The Company would wish any subsequent Modification to be made Operational.

Connect and Manage Arrangements

1.1.6 Confirmation whether the User has requested that the Enabling Works are to be greater in scope than the MITS Connection Works.

1.1.7 If the Enabling Works are to be greater in scope than the MITS Connection Works, details (to the extent available to The Company) of the concerns, reasons or technical requirements that this is seeking to address.

User Commitment Methodology

1.1.8 Confirmation that the above methodology is to be applied such that the Attributable Works provisions are required.

2. Requirements for The Company Request for a Statement of Works submitted by The Company to a Transmission Owner pursuant to Section D, Part Four, sub-paragraph 1.1.2:

2.1 The Company Request for a Statement of Works submitted by The Company to a Transmission Owner pursuant to Section D, Part Four, sub-paragraph 1.1.2 shall contain the following information:

2.1.1 The User Application Date.

2.1.2 Standard Planning Data.

2.1.3 The capacity of the Power Station connecting to the User's Distribution System.

2.1.4 The date on which The Company would wish any subsequent Modification to be made Operational.

Connect and Manage Arrangements

- 2.1.5 Confirmation whether the User has requested that the Enabling Works are to be greater in scope than the MITS Connection Works.
- 2.1.6 If the Enabling Works are to be greater in scope than the MITS Connection Works, details (to the extent available to The Company) of the concerns, reasons or technical requirements that this is seeking to address.

User Commitment Methodology

- 2.1.7 Confirmation that the above methodology is to be applied such that the Attributable Works provisions are required.

3. Requirements for The Company Request for a Statement of Works submitted by The Company to a Transmission Owner pursuant to Section D, Part Four, sub-paragraph 1.1.3:

- 3.1 The Company Request for a Statement of Works submitted by The Company to a Transmission Owner pursuant to Section D, Part Four, sub-paragraph 1.1.3 shall contain the following information:
 - 3.1.1 The User Application Date.
 - 3.1.2 The date on which The Company would wish any subsequent Modification to be made Operational.

Connect and Manage Arrangements

- 3.1.3 Confirmation whether the User has requested that the Enabling Works are to be greater in scope than the MITS Connection Works.
- 3.1.4 If the Enabling Works are to be greater in scope than the MITS Connection Works, details (to the extent available to The Company) of the concerns, reasons or technical requirements that this is seeking to address.

User Commitment Methodology

- 3.1.5 Confirmation that the above methodology is to be applied such that the Attributable Works provisions are required.

SCHEDULE FOURTEEN

NOT IN USE

SCHEDULE FIFTEEN

TRANSMISSION INTERFACE AGREEMENT

DATED _____ 20 []

[]

- and -

[]

TRANSMISSION INTERFACE AGREEMENT

Relating to the installation and operation of Transmission Assets of one party
on the property of the other party at an Interface Point

INDEX

<u>Clause</u>	<u>Title</u>	<u>Page</u>
1	Definitions and Interpretation	4
2	Right to Install and Retain Asset	9
3	Modifications, Replacements and Alterations	9
4	Security and Compliance with Statutes etc.	11
5	Relocations	13
6	Removals	15
7	Rights of Access	16
8	Services and Use of Assets	19
9	Non-Interference	20
10	Dispute Resolution	21
11	Title to Assets	22
12	STC	24
13	Variations	24
14	Good Industry Practice	24
15	Term and Termination	24
16	Registration and Memorandum	25
17	Entire Agreement	25
Schedule 1	Assets	27
Schedule 2	Land	28
Schedule 3	Part I - Security Details	29
	Part II - Plant MV LV Apparatus Safety Co-ordination Procedures	29
Schedule 4	Facility Assets	30
Schedule 5	Shared Services Provided	31

THIS DEED OF AGREEMENT is made on the _____ day of _____ 200[]

BETWEEN

- (1) **[Insert name of Relevant Transmission Licensee]** a company registered in [] with number [] whose registered office is at [(“[X]”, which expression shall include its successors and/or permitted assigns); and

- (2) **[Insert name of Relevant Transmission Licensee]** a company registered in [] with number [] whose registered office is at [] (“Y”, which expression shall include its successors and/or permitted assigns)

WHEREAS

Certain assets and facilities of the Parties are to be installed on property title to which is vested in the other and connected to the transmission system of the other and this Agreement is entered into by the Parties to give effect to appropriate arrangements in respect of such assets, the use of such assets and facilities and the connection.

NOW IT IS HEREBY AGREED as follows:-

1. DEFINITIONS AND INTERPRETATION

Unless the subject matter or context otherwise requires or is inconsistent therewith, terms and expressions defined in Section J of the System Operator Transmission Owner Code have the same meanings, interpretations or constructions in this Transmission Interface Agreement and the following terms and expressions bear the following meanings:-

“Assets”

those assets listed in Schedule 1 (including any plinths or other structures (excluding buildings) to or upon which the same are affixed and to or upon which no assets of any other person are affixed and any straps, bolts or other such things for attachment thereto) as any of the same may be Modified pursuant to this Agreement where Part 1 lists those belonging to [X] and Part 2 lists those belonging to [Y];

“Emergency Personnel”

in relation to a Party, all employees of that Party who have appropriate knowledge and experience and are recognised by that Party as being able to carry out competently and safely emergency action for the purposes of clause 9;

“Facility Asset”

those assets listed in Schedule 4 where A Part One and Part Two are assets provided by [X] to [Y] and B Part One and Part Two are assets provided by [Y] to [X];

“Land”

the land described in Schedule 2 where Part 1 is land owned by [X] and Part 2 is land owned by [Y];

“Location Managers”	[];
“Modification”	any alteration to or replacement of a Party’s Assets pursuant to clause 3.1 of this Agreement and “Modify” and “Modified” shall be construed accordingly;
“Party”	each person for the time being and from time to time party to this Agreement and any successor(s) in title to, or permitted assign(s) of, such person;
“Permitted Purpose”	means the maintenance, inspection, testing, removal, operation, modification or repair of that Party’s Assets;
“Relocation Proposal”	a proposal by one Party to the other pursuant to sub-clause 5.1 for the relocation of a Party’s Assets;
“Right of Access”	full right and liberty during the currency of this Agreement to enter upon and through and remain upon any part of the other Party’s Land (including where relevant any land over which a Party [has a right of servitude, wayleave or similar right – <i>Scotland</i>] [enjoys an easement-

England and Wales] which benefits that Party's Land and the use of which is necessary by the other Party to enable it to exercise the Right of Access hereby granted) PROVIDED to the extent necessary for a Permitted Purpose and subject to the provisions of clause 5;

"Services"

In the context of Clause 8, the goods and services specified in Schedule 5 where A Part One and Part Two are provided by [X] to [Y] and B Part One and Part Two are provided by [Y] to [X];

"Site Specific Safety Rules"

the rules, procedures or current arrangements for and relating to safety co-ordination across boundaries (to permit work to or testing on the System of one of the Parties which, for this to be done safely, requires isolation and/or other precautions on Plant and/ or MV and/or LV Apparatus whether at, adjacent to or remote from the location of the work or testing) which the Parties mutually agree to use their best endeavours to formulate as soon as possible after the date of

this Agreement and on the basis that any dispute as to their content shall be resolved in accordance with the provisions of Clause 10;

“Transmission Interface Site” [];

“Transmission Interface Site Specification” the Transmission Interface Site Specification entered into by the Parties pursuant to the STC and dated [];

In this Agreement:-

- (i) unless the context otherwise requires all references to a particular clause, sub-clause, paragraph or Schedule shall be a reference to that clause, sub-clause, paragraph or Schedule in or to this Agreement;
- (ii) the table of contents and headings are inserted for convenience only and shall be ignored in construing this Agreement;
- (iii) references to the words “include” or “including” are to be construed without limitation to the generality of the preceding words;
- (iv) unless there is something in the subject matter or the context which is inconsistent therewith, any reference to an Act of Parliament or any Section thereof or Schedule thereto, or other provision thereof or any instrument, order or regulation made thereunder shall be construed at the particular time as including

a reference to any modification, extension, replacement or re-enactment thereof then in force and to all instruments, orders or regulations then in force and made under or deriving validity from the relevant Act of Parliament; and

- (v) references to the masculine shall include the feminine and references in the singular shall include the plural and vice versa and words denoting natural persons shall include companies, corporations and any other legal entity and vice versa.

2. RIGHT TO INSTALL AND RETAIN ASSET

- 2.1 Subject to sub-clause 5.1, each Party hereby grants to the other the right to install and thereafter retain and replace as provided in this Agreement its Assets on the other's Land in such places as are currently proposed (subject to such variations between the date hereof and the actual date of installation as may be agreed to by the Party on whose Land the Assets are to be installed) and such right shall extend to any Modified Assets. The Party owning the Land shall maintain any shelter and/or support enjoyed by the other Party's Assets at the date of this Agreement or when relocated on that Land in accordance with clause 5 and grants to the other Party a Right of Access for the purpose of the maintenance, inspection, testing, removal, operation, modification or repair of any of that Party's Assets.

3. MODIFICATIONS REPLACEMENTS AND ALTERATIONS

- 3.1 A Party (the "requesting Party") may at its own expense replace or alter any of its Assets provided that:-

- 3.1.1 the replacement Assets or the Assets as so altered:-

- (i) are placed in the same or approximately the same position;
- (ii) fulfil the same or a similar purpose;
- (iii) can, where relevant, be accommodated in and on existing buildings or structures;
- (iv) do not require additional or improved facilities or services from the other Party (the “Receiving Party”);
- (v) do not restrict the actual and intended use of the Receiving Party’s Land and any equipment thereon or therein to any materially greater extent than the Assets so replaced or altered; and
- (vi) are either of the same or a similar or smaller size or the alteration is effected substantially within the space occupied by such Assets to enable the Assets to be used up to their full capability; and

3.1.2 prior written notification has been given to the Receiving Party.

3.2 If any replacement or alteration permitted by clause 3.1 shall require minor alterations or works to the existing buildings or structures housing or supporting the Asset in question, such alterations or works may be carried out (with the prior written approval of the Receiving Party (such approval not to be unreasonably withheld or delayed)) but at the cost of the Requesting Party.

3.3 To the extent that any of the conditions of clause 3.1 are not in the reasonable opinion of the Receiving Party met in relation to any replacement or alteration, the Receiving Party may by notice in writing

require the Requesting Party promptly to remove such replacement or alteration and, if it fails to do so, may remove the same itself at the cost and expense of the Requesting Party. On such removal, the Requesting Party may reinstate the Assets so replaced or altered.

- 3.4 A Party shall, if considering moving, replacing, or altering any of its Assets, give due consideration as to whether it shall be operationally practicable, desirable and reasonably economic to move such Assets to (or place the replacement or altered Assets on) its own property.
- 3.5 For avoidance of doubt it is hereby agreed that any dispute between the Parties regarding this clause shall be determined in accordance with the provisions of Clause 10 of this Agreement.

4. SECURITY AND COMPLIANCE WITH STATUTES etc

- 4.1 Each Party undertakes to maintain and provide security in relation to the Assets in accordance with the arrangements set out in Part I of Schedule 3.
- 4.2 Each Party shall procure that, as between the Parties, all reasonable and necessary steps are taken, as and when necessary or desirable, in co-operation with the other Party (and, so far as applicable, with any third party), to ensure compliance with the provisions (each such provision or part thereof being in this clause 4 an "Obligation") of:-
- (i) all statutes and Directives applicable to any Assets and/or any part (including the whole) of the Land;
 - (ii) any statute or Directive which may affect any other property (of whatever nature) of either Party as a result of the existence, nature, location, or manner of operation of any Assets; and

- (iii) any statute or Directive requiring the reporting of any occurrence relating to or affecting any Assets and/or Land (including the Reporting of Injuries Diseases and Dangerous Occurrence Regulations 1985 and the Regulations).

4.3 Each Party shall, so far as it is aware of the same, unless it has reasonable grounds for believing that the other Party possesses the information, keep the other Party informed of all matters relating to any Obligation or potential Obligation and/or the extent to which such Obligation may be applicable.

4.4 In the event of any dispute as to responsibility, as between the Parties, pursuant to clause 4.2, for compliance with an Obligation, that responsibility shall be allocated, so far as practicable, on the basis that:-

- (i) each Party shall refrain from taking or permitting any act or omission which would prevent compliance with an Obligation; and
- (ii) positive action required in relation to a Party's property as a consequence of the existence, nature, location or manner of operation of that property or any other property of that Party shall be the responsibility of that Party, and, to the extent that such action is required in respect of or affecting any property of the other Party (or property of a third party located in or on that other Party's Land), such action may be taken with the prior approval of that other Party (such approval, subject to (i) above, not to be unreasonably withheld or delayed).

4.5 The provisions for safety co-ordination between the Parties contained in Part II of Schedule 3 shall apply.

5. RELOCATIONS

5.1 At any time and from time to time during the term of this Agreement, either Party (the “Requesting Party”) may with the prior written consent of the other Party (the “Receiving Party”) (such consent not to be unreasonably withheld or delayed) require the Receiving Party to relocate any Assets either to a different location on the Requesting Party’s Land or to the Receiving Party’s Land or a third party’s land, such consent to be sought and given or refused in accordance with the following procedure:-

5.1.1 The Requesting Party shall serve a written notice on the Receiving Party, which notice shall specify:-

- (a) the Assets which the Requesting Party wishes to be relocated;
- (b) the reasons for such wish;
- (c) the proposed new location for such Assets; and
- (d) the timing of the carrying out of such relocation.

5.1.2 The Receiving Party shall within one month of receipt of any such notice (or such longer period as shall be reasonably necessary) serve a counter notice stating:-

- (a) whether or not in its reasonable opinion such Relocation Proposal is acceptable to it;

- (b) if the Relocation Proposal is not acceptable to the Receiving Party, the grounds for such opinion and the terms of any alternative proposal (the “Alternative Relocation Proposal”) covering so far as relevant the matters referred to in items (a) - (d) of clause 5.1.1 which would be acceptable to the Receiving Party; and
- (c) in respect of the Relocation Proposal (if accepted) or of any Alternative Relocation Proposal, the costs likely to be incurred in connection with considering the Relocation Proposal or the Alternative Relocation Proposal and effecting the said relocation of the Assets and the proper and reasonable costs of relocating any other equipment that may be necessary as a result of the relocation of those Assets and any consequential losses including payments to third parties incurred as a result of the relocation of those Assets and the proposed manner and timing of payment of the same by the Requesting Party.

5.1.3 If within one month of the date of such counter notice (or such longer period as shall be reasonably necessary) the Requesting Party has not withdrawn the Relocation Proposal and the Parties have not agreed upon it or the Alternative Relocation Proposal (if any) or a variation of either of them (such agreement to include agreement on the costs referred to in item (c) of clause 5.1.2) the matter shall be dealt with in accordance with Clause 10.

5.2 Upon approval or settlement of any Relocation Proposal, Alternative Relocation Proposal or variation thereof pursuant to clause 5.1, the

Receiving Party shall (conditionally upon it being able to obtain all necessary licences and consents which it will use reasonable endeavours to do) relocate or procure the relocation of the relevant Assets as quickly as reasonably practicable (having regard to, amongst other things, technical and operational requirements and to the availability of all necessary licences and consents).

5.3 The Requesting Party shall render all reasonable assistance to the Receiving Party in connection with such relocation licences and consents and pay to the Receiving Party all costs referred to in item (c) of clause 5.1.2 as agreed or settled pursuant to clause 5.1 provided that all reasonable endeavours are used to minimise such costs and in the event that a Relocation Proposal is withdrawn or consent thereto is reasonably withheld pursuant to clause 5.1, the Requesting Party shall pay to the Receiving Party all costs reasonably incurred by the receiving Party in connection with considering the Relocation Proposal and any counter notice.

5.4 Such of the provisions of this Agreement as are appropriate and relevant (including the provisions of this clause 5), shall continue to apply to any relocated Assets.

6. REMOVALS

6.1 In the event that there shall cease to be a Transmission Interface Specification relating to the Assets each Party shall [disconnect itself from the others [transmission system] and shall remove its Assets from the other Party's Land within [] or such longer period as may be agreed by the Parties. .

6.2 Where a Party (the “Failing Party”) is obliged to remove any Assets from the other Party’s Land, under this Clause 6, and fails to do so in accordance with the relevant provisions, (whether they be contained in this clause 6, clause 3 or clause 5) the other Party shall be entitled to remove the Failing Party’s Assets to land belonging to the Failing Party and the Failing Party shall provide all reasonable assistance to enable the other Party safely so to do and shall pay and reimburse to the other Party all costs and expenses reasonably incurred by the other Party in so doing.

7. RIGHTS OF ACCESS

7.1 A Right of Access includes the right to bring on to the Land such vehicles, plant, machinery and maintenance or construction materials as shall be reasonably necessary for the Permitted Purpose.

7.2 A Right of Access given to a Party may be exercised by any person, including third party contractors, reasonably nominated from time to time by that Party. To the extent (if any) that any particular authorisation or clearances may be required to be given by a Party and the procedures for giving and obtaining the same are not for the time being stipulated in arrangements made pursuant to clause 7.3, the same shall be given within a reasonable time from the date of the request therefor, save in the case of emergency in which case it shall be given without delay.

7.3 A Party shall procure that all reasonable arrangements and provisions are made and/or revised from time to time, as and when necessary or desirable, to facilitate the safe exercise by it of any Right of Access with the minimum of disruption, disturbance or inconvenience to the other Party. Such arrangements and provisions shall provide for the other

Party to have the right to make directions or regulations from time to time in relation to a specified matter. Matters to be covered by such arrangements and/or provision shall include:-

- (i) the identification of any relevant Assets;
- (ii) the particular access routes applicable to the land in question having particular regard for the weight and size limits on those routes;
- (iii) any limitations on times of exercise of a Right of Access;
- (iv) any requirements as to prior notification and as to authorisation or security clearance of individuals exercising such Rights of Access, and procedures for obtaining the same;
- (v) the means of communication between the Parties and all employees and/or contractors who may be authorised from time to time by a Party to exercise a Right of Access of any relevant directions or regulations made by the other Party;
- (vi) the identification of and arrangements applicable to Emergency Personnel.
- (vii) Any limitation or restriction on the exercise of such Right of Access to the extent that in the circumstances is reasonable

7.4 Each Party shall procure that any such arrangements and/or provisions (or directions or regulations issued by the other Party pursuant thereto) made from time to time between the Parties shall be observed and performed by it and all persons authorised by it to exercise any Right of Access.

7.4.1 A Party shall procure that all reasonable steps are taken in the exercise of any Right of Access to:-

- (a) avoid or minimise damage to the other Party's Land, or any other property thereon or therein;
- (b) cause as little disturbance and inconvenience as possible to the other Party or other occupier of the other Party's Land;

and shall promptly make good any damage caused to the other Party's Land and/or such other property in the course of the exercise of such rights and shall indemnify the other Party against all actions, claims, proceedings, losses, costs and demands arising out of such exercise.

7.4.2 Subject to clause 7.4.1, all such rights shall be exercisable free of any charge or payment of any kind.

7.5 Subject to any contrary arrangements for the time being made under clause 7.3,

7.5.1 a Right of Access for operation or inspection shall be available without prior notice;

7.5.2 a Right of Access for the purpose of maintenance, testing or repair of HV Apparatus shall only be exercisable on the giving of at least seven days prior written notice to the other Party except in the case of loss of generation or demand or other emergency (in which event the other Party shall render all possible assistance in procuring that the Right of Access shall be exercisable as soon as possible); and

7.5.3 a Right of Access for the purpose of Modifying any Assets shall be exercisable only after two weeks prior written notice to the other Party.

8. SERVICES AND USE OF ASSETS

8.1 Subject as hereinafter provided, in relation to each Facility Asset, a Party (the "Owning Party") shall, if required by the other Party (the "Receiving Party") , make the Facility Asset in question available for use by the Receiving Party to such extent as is necessary for the purposes of the Receiving Party's undertaking but not so as to prejudice the use now or hereafter of such Facility Asset by the Owning Party for its undertaking.

8.2 Subject as hereinafter provided, in relation to each Services, a Party shall, if required by the other Party (the "Receiving Party"), provide the same to the Receiving Party. Such provision shall be of such a quality and quantity and shall be provided at such times as the Receiving Party shall reasonably request. A Party shall not be required to exceed the level of quality or quantity of the Services as are anticipated by the Parties at the date of this Agreement, unless specifically agreed otherwise between the Parties.

8.3 Where the use of any Facility Asset is made available or such Services are supplied as aforesaid, the Parties shall procure that all reasonable arrangements and provisions are made and/or revised from time to time, as and when necessary or desirable between the local personnel employed by each of them in that regard, such arrangements to include:-

- 8.3.1 the identification of the Facility Asset and/or Services in question including (where relevant) the extent of their availability;
 - 8.3.2 the hours during which such use or provision shall be allowed or made;
 - 8.3.3 any requirements as to notification of use or call for supply or temporary suspension thereof;
 - 8.3.4 any requirements as to authorisation or security clearance of individuals and the procedures for obtaining the same; and
 - 8.3.5 any safety requirements.
- 8.4 The provision of use of the Facility Asset listed in Schedule 4, Part One and the supply of the Services listed in Schedule 5, Part One shall not be terminated unless the Party providing them ceases to require the Facility Asset or Services for its own use in which case the supply of the Services or use of the Facility Asset may be terminated by not less than one year's notice in writing;
- 8.5 The provision of use of the Facility Assets listed in Schedule 4, Part Two and the supply of the Services listed in Schedule 5, Part Two shall continue until terminated by not less than six months notice in writing by either Party. The Party providing the Facility Asset shall maintain the Facility Asset in accordance with Good Industry Practice.

9. NON-INTERFERENCE

- 9.1 Each Party agrees that neither it nor its agents, employees and invitees will interfere in any way with any of the other Party's Assets without the

consent of that Party. For the purposes of this clause “interfere” shall include:-

9.1.1 disconnecting or altering the connection of any of the other Party’s Assets to any system of cables, foundations, pipes, drains or other media to which it may be connected from time to time or to prevent supply of any substance or thing through such connected system;

9.1.2 affixing or removing any item or substance of any nature whatsoever to or from any of the other Party’s Assets;

9.1.3 damaging any of the other Party’s Assets;

9.1.4 allowing any other person to interfere with any of the other Party’s Assets;

9.1.5 alter any meters or settings on any of the other Party’s Assets;

9.1.6 the obstruction of access to any of the other Party’s Assets.

9.2 The obligations contained in this clause 9 shall be suspended to the extent that emergency action is taken by Emergency Personnel in good faith to protect the health and safety of persons or to prevent damage to property. All reasonable care shall be taken in the course of such emergency action. When the emergency has ended, any damaged property will be reinstated by a Party, save for damage occurring by reason of lack of reasonable care in the course of the emergency action taken by the other Party which shall be the responsibility of such Party.

10. DISPUTE RESOLUTION

- 10.1 Any dispute arising under this Agreement between Location Managers of the Parties shall, if not resolved within 14 days of first arising, be referred at the instance of either party to the respective line managers, or those fulfilling a similar function whether or not so called, of the Parties who shall use all reasonable endeavours to resolve the matter in dispute within one month.
- 10.2 Save where expressly stated in this Agreement to the contrary (including the procedure for initial dispute resolution contained in clause 10.1) and subject to any contrary provision of the Act, any Licence, or the Regulations, or the rights, powers, duties and obligations of the Authority or the Secretary of State under the Act, any Licence or otherwise howsoever, any dispute or difference of whatever nature howsoever arising under out of or in connection with this Agreement between the Parties shall (subject to any relevant initial dispute resolution procedures referred to in Clause 10.1 having been exhausted) be and is hereby referred to arbitration pursuant to the arbitration rules of the Electricity Supply Industry Arbitration Association in force from time to time.
- 10.3 Whatever the nationality residence or domicile of any Party and wherever the dispute or difference or any part thereof arose the law of England and Wales shall be the proper law of any reference to arbitration hereunder and in particular (but not so as to derogate from the generality of the foregoing) the provisions of the Arbitration Act 1996 (including any modification, extension, replacement or re-enactment thereof for the time being in force) shall apply to any such arbitration wherever the same or any part of it shall be conducted.

11. TITLE TO ASSETS

- 11.1 A Party acknowledges that it does not have and will not acquire any title, right or interest in the other's Land save for such rights as are expressly granted herein or otherwise provided nevertheless that, if according to any rule of law, a Party could acquire any such title, right or interest in any of the other Party's Land, then it undertakes [to do all that is required to transfer such right or interest to the other Party to ensure that it shall not, by reason of such right or interest arising, have its full rights in such land diminished (and in the interim to hold such rights in trust for that Party) and shall if requested by that Party, be obliged forthwith to establish trust arrangements valid under Scottish law so as to ensure that any such right or interest shall be held on behalf of that Party] [then such title, right or interest shall be held upon trust, insofar as it relates to that Party's Land, for that Party absolutely].
- 11.2 Each Party agrees that it shall not by any act or default render the other Party's Assets liable to any distress execution or other legal process, and in the event that the other Party's Assets shall become so liable, shall forthwith give notice of any such proceedings to that Party and shall forthwith notify any third party instituting any such process of the ownership of such Assets.
- 11.3 If a Party desires to mortgage or charge its Land or its interest therein on which any of the Other Party's Assets are located or to enter into any arrangement which, if made, might affect the rights of the other Party expressly granted herein, then the Party shall ensure that the other Party's Assets are not and will not be subject to the rights granted therein and are not and will not be affected by the mortgage, legal charge or other agreement or arrangement, and shall give prior written notification thereof to the other Party.

11.4 In the event that a Party shall wish to grant rights over or dispose of any interest in or change the use of it's Land that Party shall notify the other Party of such wish and fully consult it in respect thereof and shall not grant such rights or make such disposal or change of use save on terms securing to the reasonable satisfaction of that other the Rights of Access granted in respect of the it's Land.

12. STC

The provisions of STC Sections E (Payments and Billing), F (Communications and Data), G Paragraphs 4 (Limitation of Liability), 5 (Third Party Rights), 6 (Transfer and Subcontracting), 7 (Intellectual Property), 8 (Force Majeure), 9 (Privilege), 10 (Waiver), 12 (Communications), 13 (Counterparts), 14 (Severance of Terms), 15 (Language), 16 (Data Protection Act), 17 (Jurisdiction) and 18 (Governing Law) inclusive shall apply to this Transmission Interface Agreement as if set out in this Transmission Interface Agreement.

13. VARIATIONS

13.1 The provisions of Schedules 1, 3, 4, 5 and 6 may be varied from time to time by written memorandum signed by an authorised officer of each of the Parties. Subject thereto no variations to this Agreement shall be effective unless made by way of supplemental deed.

14. GOOD INDUSTRY PRACTICE

14.1 Both parties shall observe their respective obligations hereunder in accordance with Good Industry Practice

15. TERM AND TERMINATION

15.1 This Agreement shall continue until each Party has disconnected form the other Party's Transmission System at the Transmission Interface

Site and neither Party has assets on the other's Land and no Facility Assets or Services are shared or provided.

16. REGISTRATION AND MEMORANDUM (Scotland only)

16.1 Where any or all of a Party's Land is registered or a Party's interest therein is subject to compulsory registration at the [land register of Scotland] [H.M Land Registry], the Parties hereto agree to apply to the Chief Land Registrar for the registration as appropriate of the rights and obligations granted by or contained in this Agreement and to place on deposit at H.M. Land Registry all relevant Land or Charge Certificates to enable such registration to be effected.

16.2 Where any of a Party's Land is not so registered or subject to compulsory registration, the Parties shall procure within six months of the date hereof that memoranda of this Agreement are endorsed on or otherwise securely attached to the most recent conveyance (in the case of a [freehold\heritable] interest) or the lease under or pursuant to which they hold such land.

17. ENTIRE AGREEMENT

17.1 This Agreement contains the entire agreement between the Parties with respect to the subject matter hereof, and expressly excludes any warranty, condition or other undertaking implied at law or by custom, and supersedes all previous agreements and understandings between the Parties with respect thereto and:-

- (i) each of the Parties acknowledges and confirms that it does not enter into this Agreement in reliance on any representation, warranty or other undertaking not fully reflected in the terms of this Agreement; but

- (ii) Each Party acknowledges that the other Party may have entered or may enter into agreements with other parties who hold a licence containing similar rights and/or liabilities to those contained in this Agreement affecting the Land and any assets thereon. A Party shall, when entering into such agreement with any such party, use reasonable endeavours to avoid conflicts between the provisions thereof and the provisions of this Agreement but in the event of any conflict the Party shall use all reasonable endeavours to procure that appropriate arrangements are made to settle the same to give full effect (so far as practicable) to the rights and liabilities under this Agreement and under such other agreements as aforesaid. In the event of any dispute as to such conflict and/or arrangements the dispute shall be dealt with in accordance with the STC.

IN WITNESS whereof this Agreement has been entered into as a Deed the day and year first above written.

SCHEDULE 1

Assets

Part 1

Part 2

SCHEDULE 2

Land

Part 1

Part 2

SCHEDULE 3

Part I

Security Details (Clause 4.1)

Part II

Plant MV LV Apparatus Safety Coordination Procedures (Cl.4.5)

- (1) The Parties will comply with the Site Specific Safety Rules and any agreed modifications thereto.
- (2) The Parties will arrange for the Site Specific Safety Rules to be written down and to be implemented by the person or persons responsible on behalf of the relevant Parties for the co-ordination of safety.

SCHEDULE 4
FACILITY ASSETS

A

Part One

Part Two

B

Part One

Part Two

SCHEDULE 5

SHARED SERVICES PROVIDED

A

Part One

Part Two

B

Part One

Part Two

SCHEDULE 6

Addresses, Fax Nos etc

[Insert details of X]

[]

Telephone:

Facsimile:

[Insert details of Y]

[]

Telephone:

Facsimile:

THE COMMON SEAL of)
].....)
was hereunto affixed in the presence of:-)

THE COMMON SEAL of)
[])
was hereunto affixed in the presence of:-)

SCHEDULE A

This Schedule will be updated by the Panel Secretary from time to time on the Code Website to reflect changes to Parties.

Party	Registered Number	Registered Office	Category of Party
NGET	2366977	1-3 Strand, London WC2N 5EH	Onshore
SHETL	213461	Inveralmond House 200 Dunkeld Road Perth PH1 3AQ	Onshore
SPT	193794	1 Atlantic Quay Glasgow, G2 8SP	Onshore
TC Barrow OFTO Limited	7384547	Two London Bridge London, SE1 9RA	Offshore
TC Gunfleet Sands OFTO Limited	7384551	Two London Bridge, London, SE1 9RA	Offshore
TC Robin Rigg OFTO Limited	7384550	Two London Bridge, London, SE1 9RA	Offshore
TC Ormonde OFTO Limited	7456969	Two London Bridge, London, SE1 9RA	Offshore
Thanet OFTO Limited	7343534	6 th Floor 350 Euston Road London, NW1 3AX	Offshore
Blue Transmission Walney 1 Limited	7353265	c/o Law Debenture Corporate Services Limited, Fifth Floor, 100 Wood Street, London EC2V 7EX	Offshore
Blue Transmission Walney 2 Limited	7753568	The American Barns Banbury Road Lighthorne Warwickshire CV35 0AE	Offshore
Blue Transmission Sheringham Shoal Limited	8085795	The American Barns Banbury Road Lighthorne Warwickshire CV35 0AE	Offshore

Blue Transmission London Array Limited	8275752	The American Barns Banbury Road Lighthorne Warwickshire CV35 0AE	Offshore
TC Lincs OFTO Limited	8079075	Two London Bridge London, SE1 9RA	Offshore
Greater Gabbard OFTO Limited	8180541	350 Euston Road, Regents Place London, NW1 3AX	Offshore
Gwynt y Môr OFTO Limited	8796159	350 Euston Road, Regents Place London, NW1 3AX	Offshore
WODS Transmission Limited	8275752	The American Barns Banbury Road Lighthorne Warwickshire CV35 0AE	Offshore
TC Westernmost Rough OFTO Limited	9644414	Two London Bridge London, SE1 9RA	Offshore
Humber Gateway OFTO Limited	10053857	350 Euston Road, Regents Place London, NW1 3AX	Offshore