

**EUROPEAN CONNECTION CONDITIONS
(ECC)
CONTENTS**

(This contents page does not form part of the Grid Code)

<u>Paragraph No/Title</u>	<u>Page Number</u>
ECC.1 INTRODUCTION	2
ECC.2 OBJECTIVE	3
ECC.3 SCOPE	3
ECC.4 PROCEDURE	5
ECC.5 CONNECTION.....	5
ECC.6 TECHNICAL, DESIGN AND OPERATIONAL CRITERIA	7
ECC.7 SITE RELATED CONDITIONS.....	90
ECC.8 ANCILLARY SERVICES.....	98
APPENDIX E1 - SITE RESPONSIBILITY SCHEDULES.....	100
PROFORMA FOR SITE RESPONSIBILITY SCHEDULE	103
APPENDIX E2 - OPERATION DIAGRAMS	108
PART 1A - PROCEDURES RELATING TO OPERATION DIAGRAMS	108
PART E1B - PROCEDURES RELATING TO GAS ZONE DIAGRAMS.....	111
PART E2 - NON-EXHAUSTIVE LIST OF APPARATUS TO BE INCLUDED ON OPERATION DIAGRAMS.....	112
APPENDIX E3 - MINIMUM FREQUENCY RESPONSE CAPABILITY REQUIREMENT PROFILE AND OPERATING RANGE FOR POWER GENERATING MODULES AND HVDC EQUIPMENT	114
APPENDIX 4 - FAULT RIDE THROUGH REQUIREMENTS.....	120
APPENDIX E5 - TECHNICAL REQUIREMENTS LOW FREQUENCY RELAYS FOR THE AUTOMATIC DISCONNECTION OF SUPPLIES AT LOW FREQUENCY	126
APPENDIX E6 - PERFORMANCE REQUIREMENTS FOR CONTINUOUSLY ACTING AUTOMATIC EXCITATION CONTROL SYSTEMS FOR ONSHORE SYNCHRONOUS POWER GENERATING MODULES,.....	130
APPENDIX E7 - PERFORMANCE REQUIREMENTS FOR CONTINUOUSLY ACTING AUTOMATIC VOLTAGE CONTROL SYSTEMS FOR AC CONNECTED ONSHORE POWER PARK MODULES AND OTSDUW PLANT AND APPARATUS AT THE INTERFACE POINT HVDC SYSTEMS AND REMOTE END HVDC CONVERTER STATIONS	134
APPENDIX E8 - PERFORMANCE REQUIREMENTS FOR CONTINUOUSLY ACTING AUTOMATIC VOLTAGE CONTROL SYSTEMS FOR CONFIGURATION 2 AC CONNECTED OFFSHORE POWER PARK MODULES AND CONFIGURATION 2 DC CONNECTED POWER PARK MODULES	141

ECC.1

INTRODUCTION

ECC.1.1

The **European Connection Conditions** ("**ECC**") specify both:

- (a) the minimum technical, design and operational criteria which must be complied with by:
 - (i) any **EU Code User** connected to or seeking connection with the **National Electricity Transmission System**, or
 - (ii) **EU Generators** or **HVDC System Owners** connected to or seeking connection to a **User's System** which is located in **Great Britain** or **Offshore**, or
 - (iii) **Network Operators** who are **EU Code Users**
 - (iv) **Network Operators** who are **GB Code Users** but only in respect of:-
 - (a) Their obligations in respect of **Embedded Medium Power Stations** not subject to a **Bilateral Agreement** for whom the requirements of ECC.3.1(b)(iii) apply alone; and/or
 - (b) The requirements of this **ECC** only in relation to each **EU Grid Supply Point. Network Operators** in respect of all other **Grid Supply Points** should continue to satisfy the requirements as specified in the **CCs**.
 - (v) **Non-Embedded Customers** who are **EU Code Users**
- (b) the minimum technical, design and operational criteria with which **The Company** will comply in relation to the part of the **National Electricity Transmission System** at the **Connection Site** with **Users**. In the case of any **OTSDUW Plant and Apparatus**, the **ECC** also specify the minimum technical, design and operational criteria which must be complied with by the **User** when undertaking **OTSDUW**.
- (c) The requirements of **Retained EU Law** (Commission Regulation (EU) 2016/631) shall not apply to
 - (i) **Power Generating Modules** that are installed to provide backup power and operate in parallel with the **Total System** for less than 5 minutes per calendar month while the **System** is in normal state. Parallel operation during maintenance or commissioning of tests of that **Power Generating Module** shall not count towards that five minute limit.
 - (ii) **Power Generating Modules** connected to the **Transmission System** or **Network Operators System** which are not operated in synchronism with a **Synchronous Area**.
 - (iii) **Power Generating Modules** that do not have a permanent **Connection Point** or **User System Entry Point** and used by **The Company** to temporarily provide power when normal **System** capacity is partly or completely unavailable.
 - (iv) **Electricity Storage Modules**.
- (d) **Storage Users** are required to comply with the entirety of the **ECC** but are not subject to the requirements of **Retained EU Law** (Commission Regulation (EU) 2016/631, Commission Regulation (EU) 2016/1388 and Commission Regulation (EU) 2016/1485). The requirements of the **ECC** shall therefore be enforceable against **Storage Users** under the Grid Code only (and not under any of the aforementioned **Retained EU Law**) and any derogation sought by a **Storage User** in respect of the **ECC** shall be deemed a derogation from the Grid Code only (and not from the aforementioned **Retained EU Law**).

ECC.2 OBJECTIVE

ECC.2.1 The objective of the **ECC** is to ensure that by specifying minimum technical, design and operational criteria the basic rules for connection to the **National Electricity Transmission System** and (for certain **Users**) to a **User's System** are similar for all **Users** of an equivalent category and will enable **The Company** to comply with its statutory and **Transmission Licence** obligations and the applicable **Retained EU Law**.

ECC.2.2 In the case of any **OTSDUW** the objective of the **ECC** is to ensure that by specifying the minimum technical, design and operational criteria the basic rules relating to an **Offshore Transmission System** designed and constructed by an **Offshore Transmission Licensee** and designed and/or constructed by a **User** under the **OTSDUW Arrangements** are equivalent.

ECC.2.3 Provisions of the **ECC** which apply in relation to **OTSDUW** and **OTSUA**, and/or a **Transmission Interface Site**, shall (in any particular case) apply up to the **OTSUA Transfer Time**, whereupon such provisions shall (without prejudice to any prior non-compliance) cease to apply, without prejudice to the continuing application of provisions of the **ECC** applying in relation to the relevant **Offshore Transmission System** and/or **Connection Site**. It is the case therefore that in cases where the **OTSUA** becomes operational prior to the **OTSUA Transfer Time** that a **EU Generator** is required to comply with this **ECC** both as it applies to its **Plant** and **Apparatus** at a **Connection Site/Connection Point** and the **OTSUA** at the **Transmission Interface Site/Transmission Interface Point** until the **OTSUA Transfer Time** and this **ECC** shall be construed accordingly.

ECC.2.4 In relation to **OTSDUW**, provisions otherwise to be contained in a **Bilateral Agreement** may be contained in the **Construction Agreement**, and accordingly a reference in the **ECC** to a relevant **Bilateral Agreement** includes the relevant **Construction Agreement**.

ECC.3 SCOPE

ECC.3.1 The **ECC** applies to **The Company** and to **Users**, which in the **ECC** means:

- (a) **EU Generators** (other than those which only have **Embedded Small Power Stations**), including those undertaking **OTSDUW** including **Power Generating Modules**, and **DC Connected Power Park Modules**. For the avoidance of doubt, **Electricity Storage Modules** are included within the definition of **Power Generating Modules** for which the requirements of the **ECC** would be equally applicable.
- (b) **Network Operators** but only in respect of:-
 - (i) **Network Operators** who are **EU Code Users**
 - (ii) **Network Operators** who only have **EU Grid Supply Points**
 - (iii) **Embedded Medium Power Stations** not subject to a **Bilateral Agreement** as provided for in ECC.3.2, ECC.3.3, EC3.4, EC3.5, ECC5.1, ECC.6.4.4 and ECA.3.4;
 - (iv) Notwithstanding the requirements of ECC3.1(b)(i)(ii) and (iii), **Network Operators** who own and/or operate **EU Grid Supply Points**, are only required to satisfy the requirements of this **ECC** in relation to each **EU Grid Supply Point**. **Network Operators** in respect of all other **Grid Supply Points** should continue to satisfy the requirements as specified in the **CCs**.
- (c) **Non-Embedded Customers** who are also **EU Code Users**;
- (d) **HVDC System Owners** who are also **EU Code Users**;
- (e) **BM Participants** and **Externally Interconnected System Operators** who are also **EU Code Users** in respect of ECC.6.5, ECC.7.9, ECC.7.10 and ECC.7.11 only; and.

- (f) In relation to **Distribution Restoration Zones, Restoration Contractors** who are **Non-CUSC Parties** and whose **Embedded Plant** needs to comply with the requirements of EREC G99, other than those included in (a) to (e) above, shall only be required to satisfy ECC.6.1.2, ECC.6.2.2.1.2, ECC.6.2.2.7, ECC.6.3, ECC.6.6, ECC.7.10, ECC.7.11 and ECC.8.1 unless additional technical requirements are provided for in the **Anchor Restoration Contract** or **Top Up Restoration Contract**. **Restoration Contractors** who are **Non-CUSC Parties** and whose **Embedded Plant** needs to comply with EREC G59 are not included in the scope of the **ECC** and should refer to the **CC**.

ECC.3.2 The above categories of **User** will become bound by the applicable sections of the **ECC** prior to them generating, distributing, storing, supplying or consuming, as the case may be, and references to the various categories should, therefore, be taken as referring to them in that prospective role.

ECC.3.3 **Embedded Medium Power Stations** not subject to a **Bilateral Agreement** and **Embedded HVDC Systems** not subject to a **Bilateral Agreement** Provisions.

The following provisions apply in respect of **Embedded Medium Power Stations** not subject to a **Bilateral Agreement** and **Embedded HVDC Systems** not subject to a **Bilateral Agreement**.

ECC.3.3.1 The obligations within the **ECC** that are expressed to be applicable to **EU Generators** in respect of **Embedded Medium Power Stations** not subject to a **Bilateral Agreement** and **HVDC System Owners** in respect of **Embedded HVDC Systems** not subject to a **Bilateral Agreement** (where the obligations are in each case listed in ECC.3.3.2) shall be read and construed as obligations that the **Network Operator** within whose **System** any such **Medium Power Station** or **HVDC System** is **Embedded** must ensure are performed and discharged by the **EU Generator** or the **HVDC Owner**. **Embedded Medium Power Stations** not subject to a **Bilateral Agreement** and **Embedded HVDC Systems** not subject to a **Bilateral Agreement** which are located **Offshore** and which are connected to an **Onshore User System** will be required to meet the applicable requirements of the Grid Code as though they are an **Onshore Generator** or **Onshore HVDC System Owner** connected to an **Onshore User System Entry Point**.

ECC.3.3.2 The **Network Operator** within whose **System** a **Medium Power Station** not subject to a **Bilateral Agreement** is **Embedded** or a **HVDC System** not subject to a **Bilateral Agreement** is **Embedded** must ensure that the following obligations in the **ECC** are performed and discharged by the **EU Generator** in respect of each such **Embedded Medium Power Station** or the **HVDC System Owner** in the case of an **Embedded HVDC System**:

ECC.5.1

ECC.5.2.2

ECC.5.3

ECC.6.1.3

ECC.6.1.5 (b)

ECC.6.3.2, ECC.6.3.3, ECC.6.3.4, ECC.6.3.6, ECC.6.3.7, ECC.6.3.8, ECC.6.3.9, ECC.6.3.10, ECC.6.3.12, ECC.6.3.13, ECC.6.3.15, ECC.6.3.16

ECC.6.4.4

ECC.6.5.6 (where required by ECC.6.4.4)

In respect of ECC.6.2.2.2, ECC.6.2.2.3, ECC.6.2.2.5, ECC.6.1.5(a), ECC.6.1.5(b) and ECC.6.3.11 equivalent provisions as co-ordinated and agreed with the **Network Operator** and **EU Generator** or **HVDC System Owner** may be required. Details of any such requirements will be notified to the **Network Operator** in accordance with ECC.3.5.

ECC.3.3.3 In the case of **Embedded Medium Power Stations** not subject to a **Bilateral Agreement** and **Embedded HVDC Systems** not subject to a **Bilateral Agreement** the requirements in:

ECC.6.1.6
ECC.6.3.8
ECC.6.3.12
ECC.6.3.15
ECC.6.3.16
ECC.6.3.17

that would otherwise have been specified in a **Bilateral Agreement** will be notified to the relevant **Network Operator** in writing in accordance with the provisions of the **CUSC** and the **Network Operator** must ensure such requirements are performed and discharged by the **Generator** or the **HVDC System** owner.

ECC.3.4 In the case of **Offshore Embedded Power Generating Modules** connected to an **Offshore User's System** which directly connects to an **Offshore Transmission System**, any additional requirements in respect of such **Offshore Embedded Power Generating Modules** may be specified in the relevant **Bilateral Agreement** with the **Network Operator** or in any **Bilateral Agreement** between **The Company** and such **Offshore Generator**.

ECC.3.5 In the case of a **Generator** undertaking **OTSDUW** connecting to an **Onshore Network Operator's System**, any additional requirements in respect of such **OTSDUW Plant and Apparatus** will be specified in the relevant **Bilateral Agreement** with the **EU Generator**. For the avoidance of doubt, requirements applicable to **EU Generators** undertaking **OTSDUW** and connecting to a **Network Operator's User System**, shall be consistent with those applicable requirements of **Generators** undertaking **OTSDUW** and connecting to a **Transmission Interface Point**.

ECC.3.6 The requirements of this **ECC** shall apply to **EU Code Users** in respect of **Power Generating Modules** (including **DC Connected Power Park Modules** and **Electricity Storage Modules**) and **HVDC Systems**.

ECC.4 PROCEDURE

ECC.4.1 The **CUSC** contains certain provisions relating to the procedure for connection to the **National Electricity Transmission System** or, in the case of **Embedded Power Stations** or **Embedded HVDC Systems**, becoming operational and includes provisions relating to certain conditions to be complied with by **EU Code Users** prior to and during the course of **The Company** notifying the **User** that it has the right to become operational. The procedure for an **EU Code User** to become connected is set out in the **Compliance Processes**.

ECC.5 CONNECTION

ECC.5.1 The provisions relating to connecting to the **National Electricity Transmission System** (or to a **User's System** in the case of a connection of an **Embedded Large Power Station** or **Embedded Medium Power Stations** or **Embedded HVDC System**) are contained in:

- (a) the **CUSC** and/or **CUSC Contract** (or in the relevant application form or offer for a **CUSC Contract**);
- (b) or, in the case of an **Embedded Development**, the relevant **Distribution Code** and/or the **Embedded Development Agreement** for the connection (or in the relevant application form or offer for an **Embedded Development Agreement**),

and include provisions relating to both the submission of information and reports relating to compliance with the relevant **European Connection Conditions** for that **EU Code User**, **Safety Rules**, commissioning programmes, **Operation Diagrams** and approval to connect (and their equivalents in the case of **Embedded Medium Power Stations** not subject to a **Bilateral Agreement** or **Embedded HVDC Systems** not subject to a **Bilateral Agreement**). References in the **ECC** to the "**Bilateral Agreement**" and/or "**Construction Agreement**" and/or "**Embedded Development Agreement**" shall be deemed to include references to the application form or offer therefor.

ECC.5.2 Items For Submission

ECC.5.2.1 Prior to the **Completion Date** (or, where the **EU Generator** is undertaking **OTSDUW**, any later date specified) under the **Bilateral Agreement** and/or **Construction Agreement**, the following is submitted pursuant to the terms of the **Bilateral Agreement** and/or **Construction Agreement**:

- (a) updated **Planning Code** data (both **Standard Planning Data** and **Detailed Planning Data**), with any estimated values assumed for planning purposes confirmed or, where practical, replaced by validated actual values and by updated estimates for the future and by updated forecasts for **Forecast Data** items such as **Demand**, pursuant to the requirements of the **Planning Code**;
- (b) details of the **Protection** arrangements and settings referred to in ECC.6;
- (c) copies of all **Safety Rules** and **Local Safety Instructions** applicable at **Users' Sites** which will be used at the **Transmission/User** interface (which, for the purpose of **OC8**, must be to **The Company's** satisfaction regarding the procedures for **Isolation** and **Earthing**. **The Company** will consult the **Relevant Transmission Licensee** when determining whether the procedures for **Isolation** and **Earthing** are satisfactory);
- (d) information to enable the preparation of the **Site Responsibility Schedules** on the basis of the provisions set out in Appendix 1;
- (e) an **Operation Diagram** for all **HV Apparatus** on the **User** side of the **Connection Point** as described in ECC.7;
- (f) the proposed name of the **User Site** (which shall not be the same as, or confusingly similar to, the name of any **Transmission Site** or of any other **User Site**);
- (g) written confirmation that **Safety Co-ordinators** acting on behalf of the **User** are authorised and competent pursuant to the requirements of **OC8**;
- (h) Such **RISSP** prefixes pursuant to the requirements of **OC8**. Such **RISSP** prefixes shall be circulated utilising a proforma in accordance with **OC8**;
- (i) a list of the telephone numbers for **Joint System Incidents** at which senior management representatives nominated for the purpose can be contacted and confirmation that they are fully authorised to make binding decisions on behalf of the **User**, pursuant to **OC9**;
- (j) a list of managers who have been duly authorised to sign **Site Responsibility Schedules** on behalf of the **User**;
- (k) information to enable the preparation of the **Site Common Drawings** as described in ECC.7;
- (l) a list of the telephone numbers for the **Users** facsimile machines referred to in ECC.6.5.9; and
- (m) for **Sites** in Scotland and **Offshore** a list of persons appointed by the **User** to undertake operational duties on the **User's System** (including any **OTSDUW** prior to the **OTSUA Transfer Time**) and to issue and receive operational messages and instructions in relation to the **User's System** (including any **OTSDUW** prior to the **OTSUA Transfer Time**); and an appointed person or persons responsible for the maintenance and testing of **User's Plant and Apparatus**.

- ECC.5.2.2 Prior to the **Completion Date** the following must be submitted to **The Company** by the **Network Operator** in respect of an **Embedded Development**:
- (a) updated **Planning Code** data (both **Standard Planning Data** and **Detailed Planning Data**), with any estimated values assumed for planning purposes confirmed or, where practical, replaced by validated actual values and by updated estimates for the future and by updated forecasts for **Forecast Data** items such as **Demand**, pursuant to the requirements of the **Planning Code**;
 - (b) details of the **Protection** arrangements and settings referred to in ECC.6;
 - (c) the proposed name of the **Embedded Medium Power Station** or **Embedded HVDC System** (which shall be agreed with **The Company** unless it is the same as, or confusingly similar to, the name of other **Transmission Site** or **User Site**);
- ECC.5.2.3 Prior to the **Completion Date** contained within an **Offshore Transmission Distribution Connection Agreement** the following must be submitted to **The Company** by the **Network Operator** in respect of a proposed new **Interface Point** within its **User System**:
- (a) updated **Planning Code** data (both **Standard Planning Data** and **Detailed Planning Data**), with any estimated values assumed for planning purposes confirmed or, where practical, replaced by validated actual values and by updated estimates for the future and by updated forecasts for **Forecast Data** items such as **Demand**, pursuant to the requirements of the **Planning Code**;
 - (b) details of the **Protection** arrangements and settings referred to in ECC.6;
 - (c) the proposed name of the **Interface Point** (which shall not be the same as, or confusingly similar to, the name of any **Transmission Site** or of any other **User Site**);
- ECC.5.2.4 In the case of **OTSDUW Plant and Apparatus** (in addition to items under ECC.5.2.1 in respect of the **Connection Site**), prior to the **Completion Date** (or any later date specified) under the **Construction Agreement** the following must be submitted to **The Company** by the **User** in respect of the proposed new **Connection Point** and **Interface Point**:
- (a) updated **Planning Code** data (**Standard Planning Data**, **Detailed Planning Data** and **OTSDUW Data and Information**), with any estimated values assumed for planning purposes confirmed or, where practical, replaced by validated actual values and by updated estimates for the future and by updated forecasts for **Forecast Data** items such as **Demand**, pursuant to the requirements of the **Planning Code**;
 - (b) details of the **Protection** arrangements and settings referred to in ECC.6;
 - (c) information to enable preparation of the **Site Responsibility Schedules** at the **Transmission Interface Site** on the basis of the provisions set out in Appendix E1.
 - (d) the proposed name of the **Interface Point** (which shall not be the same as, or confusingly similar to, the name of any **Transmission Site** or of any other **User Site**);
- ECC.5.3
- (a) Of the items ECC.5.2.1 (c), (e), (g), (h), (k) and (m) need not be supplied in respect of **Embedded Power Stations** or **Embedded HVDC Systems**,
 - (b) item ECC.5.2.1(i) need not be supplied in respect of **Embedded Small Power Stations** and **Embedded Medium Power Stations** or **Embedded HVDC Systems** with a **Registered Capacity** of less than 100MW, and
 - (c) items ECC.5.2.1(d) and (j) are only needed in the case where the **Embedded Power Station** or the **Embedded HVDC System** is within a **Connection Site** with another **User**.

ECC.6 TECHNICAL, DESIGN AND OPERATIONAL CRITERIA

ECC.6.1 National Electricity Transmission System Performance Characteristics

ECC.6.1.1 **The Company** shall ensure that, subject as provided in the **Grid Code**, the **National Electricity Transmission System** complies with the following technical, design and operational criteria in relation to the part of the **National Electricity Transmission System** at the **Connection Site** with a **User** and in the case of **OTSDUW Plant and Apparatus**, a **Transmission Interface Point** (unless otherwise specified in ECC.6) although in relation to operational criteria **The Company** may be unable (and will not be required) to comply with this obligation to the extent that there are insufficient **Power Stations** or **User Systems** are not available or **Users** do not comply with **The Company's** instructions or otherwise do not comply with the **Grid Code** and each **User** shall ensure that its **Plant** and **Apparatus** complies with the criteria set out in ECC.6.1.5.

ECC.6.1.2 Grid Frequency Variations

ECC.6.1.2.1 Grid Frequency Variations

ECC.6.1.2.1.1 The **Frequency** of the **National Electricity Transmission System** shall be nominally 50Hz and shall be controlled within the limits of 49.5 - 50.5Hz unless exceptional circumstances prevail, for example but not limited to, situations such as during **System Restoration**.

ECC.6.1.2.1.2 The **System Frequency** could rise to 52Hz or fall to 47Hz in exceptional circumstances. Design of **User's Plant** and **Apparatus** and **OTSDUW Plant and Apparatus** must enable operation of that **Plant** and **Apparatus** within that range in accordance with the following:

<u>Frequency Range</u>	<u>Requirement</u>
51.5Hz - 52Hz	Operation for a period of at least 15 minutes is required each time the Frequency is above 51.5Hz.
51Hz - 51.5Hz	Operation for a period of at least 90 minutes is required each time the Frequency is above 51Hz.
49.0Hz - 51Hz	Continuous operation is required
47.5Hz - 49.0Hz	Operation for a period of at least 90 minutes is required each time the Frequency is below 49.0Hz.
47Hz - 47.5Hz	Operation for a period of at least 20 seconds is required each time the Frequency is below 47.5Hz.

ECC.6.1.2.1.3 For the avoidance of doubt, disconnection, by frequency or speed based relays is not permitted within the frequency range 47.5Hz to 51.5Hz. **EU Generators** should however be aware of the combined voltage and frequency operating ranges as defined in ECC.6.3.12 and ECC.6.3.13.

ECC.6.1.2.1.4 **The Company** in co-ordination with the **Relevant Transmission Licensee** and/or **Network Operator** and a **User** may agree on wider variations in frequency or longer minimum operating times to those set out in ECC.6.1.2.1.2 or specific requirements for combined frequency and voltage deviations, for example but not limited to, situations such as during **System Restoration**. Any such requirements in relation to **Power Generating Modules** shall be in accordance with ECC.6.3.12 and ECC.6.3.13. A **User** shall not unreasonably withhold consent to apply wider frequency ranges or longer minimum times for operation taking account of their economic and technical feasibility.

ECC.6.1.2.2 Grid Frequency variations for HVDC Systems and Remote End HVDC Converter Stations

ECC.6.1.2.2.1 **HVDC Systems** and **Remote End HVDC Converter Stations** shall be capable of staying connected to the **System** and remaining operable within the frequency ranges and time periods specified in Table ECC.6.1.2.2 below. This requirement shall continue to apply during the **Fault Ride Through** conditions defined in ECC.6.3.15

Frequency Range (Hz)	Time Period for Operation (s)
47.0 – 47.5Hz	60 seconds
47.5 – 49.0Hz	90 minutes and 30 seconds
49.0 – 51.0Hz	Unlimited

51.0 – 51.5Hz	90 minutes and 30 seconds
51.5Hz – 52 Hz	20 minutes

Table ECC.6.1.2.2 – Minimum time periods **HVDC Systems and Remote End HVDC Converter Stations** shall be able to operate for different frequencies deviating from a nominal value without disconnecting from the **National Electricity Transmission System**

ECC.6.1.2.2.2 **The Company** in coordination with the **Relevant Transmission Licensee** and a **HVDC System Owner** may agree wider frequency ranges or longer minimum operating times if required to preserve or restore system security, for example but not limited to, situations such as during **System Restoration**. If wider frequency ranges or longer minimum times for operation are economically and technically feasible, the **HVDC System Owner** shall not unreasonably withhold consent.

ECC.6.1.2.2.3 Notwithstanding the requirements of ECC.6.1.2.2.1, an **HVDC System or Remote End HVDC Converter Station** shall be capable of automatic disconnection at frequencies specified by **The Company** and/or **Relevant Network Operator**.

ECC.6.1.2.2.4 In the case of **Remote End HVDC Converter Stations** where the **Remote End HVDC Converter Station** is operating at either nominal frequency other than 50Hz or a variable frequency, the requirements defined in ECC.6.1.2.2.1 to ECC.6.1.2.2.3 shall apply to the **Remote End HVDC Converter Station** other than in respect of the frequency ranges and time periods.

ECC.6.1.2.3 **Grid Frequency Variations for DC Connected Power Park Modules**

ECC.6.1.2.3.1 **DC Connected Power Park Modules** shall be capable of staying connected to the **Remote End DC Converter** network at the HVDC Interface Point and operating within the **Frequency** ranges and time periods specified in Table ECC.6.1.2.3 below. Where a nominal frequency other than 50Hz, or a **Frequency** variable by design is used as agreed with **The Company** and the **Relevant Transmission Licensee** the applicable **Frequency** ranges and time periods shall be specified in the **Bilateral Agreement** which shall (where applicable) reflect the requirements in Table ECC.6.1.2.3 .

Frequency Range (Hz)	Time Period for Operation (s)
47.0 – 47.5Hz	20 seconds
47.5 – 49.0Hz	90 minutes
49.0 – 51.0Hz	Unlimited
51.0 – 51.5Hz	90 minutes
51.5Hz – 52 Hz	15 minutes

Table ECC.6.1.2.3 – Minimum time periods a **DC Connected Power Park Module** shall be able to operate for different frequencies deviating from a nominal value without disconnecting from the **System**

ECC.6.1.2.3.2 **The Company** in coordination with the **Relevant Transmission Licensee** and a **Generator** may agree wider frequency ranges or longer minimum operating times if required to preserve or restore system security and to ensure the optimum capability of the **DC Connected Power Park Module**, for example but not limited to, situations such as during **System Restoration**. If wider frequency ranges or longer minimum times for operation are economically and technically feasible, the **EU Generator** shall not unreasonably withhold consent.

ECC.6.1.3 Not used

ECC.6.1.4 **Grid Voltage Variations**

ECC.6.1.4.1 Grid Voltage Variations for Users excluding DC Connected Power Park Modules and Remote End HVDC Converters

The voltage on part of the **National Electricity Transmission System** operating at nominal voltages of greater than 300kV at each **Connection Site** with a **User** (and in the case of **OTSDUW Plant and Apparatus**, a **Transmission Interface Point**, excluding **DC Connected Power Park Modules** and **Remote End HVDC Converters**) will normally remain within $\pm 5\%$ of the nominal value unless abnormal conditions prevail. The minimum voltage is -10% and the maximum voltage is $+10\%$ unless abnormal conditions prevail, for example, but not limited to, situations such as during **System Restoration**, but voltages between $+5\%$ and $+10\%$ will not last longer than 15 minutes unless abnormal conditions prevail. For nominal voltages of 110kV and up to and including 300kV voltages on the parts of the **National Electricity Transmission System** at each **Connection Point** (and in the case of **OTSDUW Plant and Apparatus**, a **Transmission Interface Point**) will normally remain within the limits $\pm 10\%$ of the nominal value unless abnormal conditions prevail for example, but not limited to, situations such as during **System Restoration**. At nominal **System** voltages below 110kV the voltage of the **National Electricity Transmission System** at each **Connection Site** with a **User** (and in the case of **OTSDUW Plant and Apparatus**, a **Transmission Interface Point**), excluding **Connection Sites** for **DC Connected Power Park Modules** and **Remote End HVDC Converters**) will normally remain within the limits $\pm 6\%$ of the nominal value unless abnormal conditions prevail for example but not limited to, situations such as during **System Restoration**. Under fault conditions, the voltage may collapse transiently to zero at the point of fault until the fault is cleared. The normal operating ranges of the **National Electricity Transmission System** are summarised below:

National Electricity Transmission System Nominal Voltage	Normal Operating Range		Time period for Operation
	Voltage (percentage of Nominal Voltage)	Pu (1 pu relates to the Nominal Voltage)	
Greater than 300kV	V -10% to +5%	0.90pu- 1.05pu	Unlimited
	V +5% to +10%	1.05pu- 1.10pu	15 minutes
110kV up to 300kV	V $\pm 10\%$	0.90- 1.10pu	Unlimited
Below 110kV	$\pm 6\%$	0.94pu- 1.06pu	Unlimited

The Company and a **User** may agree greater variations or longer minimum time periods of operation in voltage to those set out above in relation to a particular **Connection Site**, and insofar as a greater variation is agreed, the relevant figure set out above shall, in relation to that **User** at the particular **Connection Site**, be replaced by the figure agreed.

ECC.6.1.4.2 Grid Voltage Variations for all DC Connected Power Park Modules

ECC.6.1.4.2.1 All **DC Connected Power Park Modules** shall be capable of staying connected to the **Remote End HVDC Converter Station** at the **HVDC Interface Point** and operating within the voltage ranges and time periods specified in Tables ECC.6.1.4.2(a) and ECC.6.1.4.2(b) below. The applicable voltage range and time periods specified are selected based on the reference 1pu voltage.

Voltage Range (pu)	Time Period for Operation (s)
0.85pu – 0.9pu	60 minutes
0.9pu – 1.1pu	Unlimited
1.1pu – 1.15pu	15 minutes

Table ECC.6.1.4.2(a) – Minimum time periods for which **DC Connected Power Park Modules** shall be capable of operating for different voltages deviating from reference 1pu without disconnecting from the network where the nominal voltage base is 110kV or above and less than 300kV.

Voltage Range (pu)	Time Period for Operation (s)
0.85pu – 0.9pu	60 minutes
0.9pu – 1.05pu	Unlimited
1.05pu – 1.15pu	15 minutes

Table ECC.6.1.4.2(b) – Minimum time periods for which **DC Connected Power Park Modules** shall be capable of operating for different voltages deviating from reference 1pu without disconnecting from the network where the nominal voltage base is from 300kV up to and including 400kV.

ECC.6.1.4.2.2 **The Company** and a **EU Generator** in respect of a **DC Connected Power Park Module** may agree greater voltage ranges or longer minimum operating times. If greater voltage ranges or longer minimum times for operation are economically and technically feasible, the **EU Generator** shall not unreasonably withhold any agreement .

ECC.6.1.4.2.3 For **DC Connected Power Park Modules** which have an **HVDC Interface Point** to the **Remote End HVDC Converter Station**, **The Company** in coordination with the **Relevant Transmission Licensee** may specify voltage limits at the **HVDC Interface Point** at which the **DC Connected Power Park Module** is capable of automatic disconnection.

ECC.6.1.4.2.4 For **HVDC Interface Points** which fall outside the scope of ECC.6.1.4.2.1, ECC.6.1.4.2.2 and ECC.6.1.4.2.3, **The Company** in coordination with the **Relevant Transmission Licensee** shall specify any applicable requirements at the **Grid Entry Point** or **User System Entry Point**.

ECC.6.1.4.2.5 Where the nominal frequency of the AC collector **System** which is connected to an **HVDC Interface Point** is at a value other than 50Hz, the voltage ranges and time periods specified by **The Company** in coordination with the **Relevant Transmission Licensee** shall be proportional to the values specified in Table ECC.6.1.4.2(a) and Table ECC.6.1.4.2(b)

ECC.6.1.4.3 Grid Voltage Variations for all Remote End HVDC Converters

ECC.6.1.4.3.1 All **Remote End HVDC Converter Stations** shall be capable of staying connected to the **HVDC Interface Point** and operating within the voltage ranges and time periods specified in Tables ECC.6.1.4.3(a) and ECC.6.1.4.3(b) below. The applicable voltage range and time periods specified are selected based on the reference 1pu voltage.

Voltage Range (pu)	Time Period for Operation (s)
0.85pu – 0.9pu	60 minutes
0.9pu – 1.1pu	Unlimited
1.1pu – 1.15pu	15 minutes

Table ECC.6.1.4.3(a) – Minimum time periods for which a **Remote End HVDC Converter** shall be capable of operating for different voltages deviating from reference 1pu without disconnecting from the network where the nominal voltage base is 110kV or above and less than 300kV.

Voltage Range (pu)	Time Period for Operation (s)
0.85pu – 0.9pu	60 minutes
0.9pu – 1.05pu	Unlimited

1.05pu – 1.15pu	15 minutes
-----------------	------------

Table ECC.6.1.4.3(b) – Minimum time periods for which a **Remote End HVDC Converter** shall be capable of operating for different voltages deviating from reference 1pu without disconnecting from the network where the nominal voltage base is from 300kV up to and including 400kV.

ECC.6.1.4.3.2 **The Company** and a **HVDC System Owner** may agree greater voltage ranges or longer minimum operating times which shall be in accordance with the requirements of ECC.6.1.4.2.

ECC.6.1.4.3.4 For **HVDC Interface Points** which fall outside the scope of ECC.6.1.4.3.1 **The Company** in coordination with the **Relevant Transmission Licensee** shall specify any applicable requirements at the **Grid Entry Point** or **User System Entry Point**.

ECC.6.1.4.3.5 Where the nominal frequency of the AC collector **System** which is connected to an **HVDC Interface Point** is at a value other than 50Hz, the voltage ranges and time periods specified by **The Company** in coordination with the **Relevant Transmission Licensee** shall be proportional to the values specified in Table ECC.6.1.4.3(a) and Table ECC.6.1.4.3(b)

Voltage Waveform Quality

ECC.6.1.5 All **Plant** and **Apparatus** connected to the **National Electricity Transmission System**, and that part of the **National Electricity Transmission System** at each **Connection Site** or, in the case of **OTSDUW Plant and Apparatus**, at each **Interface Point**, should be capable of withstanding the following distortions of the voltage waveform in respect of harmonic content and phase unbalance:

(a) Harmonic Content

The **Electromagnetic Compatibility Levels** for harmonic distortion on the **Onshore Transmission System** from all sources under both **Planned Outage** and fault outage conditions, (unless abnormal conditions prevail) shall comply with **Engineering Recommendation G5**. The **Electromagnetic Compatibility Levels** for harmonic distortion on an **Offshore Transmission System** will be defined in relevant **Bilateral Agreements**.

Engineering Recommendation G5 contains planning criteria which **The Company** will apply to the connection of non-linear **Load** to the **National Electricity Transmission System**, which may result in harmonic emission limits being specified for these **Loads** in the relevant **Bilateral Agreement**. The application of the planning criteria will take into account the position of existing **GB Code User's** and **EU Code Users' Plant and Apparatus** (and **OTSDUW Plant and Apparatus**) in relation to harmonic emissions. **EU Code Users** must ensure that connection of distorting loads to their **User Systems** do not cause any harmonic emission limits specified in the **Bilateral Agreement**, or where no such limits are specified, the relevant planning levels specified in **Engineering Recommendation G5** to be exceeded.

(b) Phase Unbalance

Under **Planned Outage** conditions, the weekly 95 percentile of **Phase (Voltage) Unbalance**, calculated in accordance with IEC 61000-4-30 and IEC 61000-3-13, on the **National Electricity Transmission System** for voltages above 150kV should remain, in England and Wales, below 1.5%, and in Scotland, below 2%, and for voltages of 150kV and below, across GB below 2%, unless abnormal conditions prevail and **Offshore** (or in the case of **OTSDUW, OTSDUW Plant and Apparatus**) will be defined in relevant **Bilateral Agreements**.

The Phase Unbalance is calculated from the ratio of root mean square (rms) of negative phase sequence voltage to rms of positive phase sequence voltage, based on 10-minute average values, in accordance with IEC 61000-4-30.

ECC.6.1.6 Across GB, under the **Planned Outage** conditions stated in ECC.6.1.5(b) infrequent short duration peaks with a maximum value of 2% are permitted for **Phase (Voltage) Unbalance**, for voltages above 150kV, subject to the prior agreement of **The Company** under the **Bilateral Agreement** and in relation to **OTSDUW**, the **Construction Agreement**. **The Company** will only agree following a specific assessment of the impact of these levels on **Transmission Apparatus** and other **Users Apparatus** with which it is satisfied.

Voltage Fluctuations

ECC.6.1.7 Voltage changes at a **Point of Common Coupling** on the **Onshore Transmission System** shall not exceed:

(a) The limits specified in Table ECC.6.1.7(a) with the stated frequency of occurrence, where:

(i)

$$\% \Delta V_{\text{steadystate}} = \left| 100 \times \frac{\Delta V_{\text{steadystate}}}{V_n} \right| \quad \text{and}$$

$$\% \Delta V_{\text{max}} = 100 \times \frac{\Delta V_{\text{max}}}{V_n} ;$$

- (ii) V_n is the nominal system voltage;
- (iii) $V_{\text{steadystate}}$ is the voltage at the end of a period of 1 s during which the rate of change of system voltage over time is $\leq 0.5\%$;
- (iv) $\Delta V_{\text{steadystate}}$ is the difference in voltage between the initial steady state voltage prior to the RVC (V_0) and the final steady state voltage after the RVC (V_0);
- (v) ΔV_{max} is the absolute change in the system voltage relative to the initial steady state system voltage (V_0);
- (vi) All voltages are the r.m.s. of the voltage measured over one cycle refreshed every half a cycle as per BS EN 61000-4-30; and
- (vii) The applications in the 'Example Applicability' column are examples only and are not definitive.

Cat-egory	Title	Maximum number of occurrence	Limits $\% \Delta V_{\text{max}}$ & $\% \Delta V_{\text{steadystate}}$	Example Applicability
1	Frequent events	(see NOTE 1)	As per Figure ECC.6.1.7 (1)	Any single or repetitive RVC that falls inside Figure ECC.6.1.7 (1)
2	Infrequent events	4 events in 1 calendar month (see NOTE 2)	As per Figure ECC.6.1.7 (2) $ \% \Delta V_{\text{steadystate}} \leq 3\%$ For decrease in voltage: $ \% \Delta V_{\text{max}} \leq 10\%$ (see NOTE 3) For increase in voltage: $ \% \Delta V_{\text{max}} \leq 6\%$ (see NOTE 4)	Infrequent motor starting, transformer energisation, re-energisation (see NOTE 7)

3	Very infrequent events	1 event in 3 calendar months (see NOTE 2)	<p>As per Figure ECC.6.1.7 (3)</p> $ \% \Delta V_{\text{steadystate}} \leq 3\%$ <p>For decrease in voltage:</p> $ \% \Delta V_{\text{max}} \leq 12\%$ <p>(see NOTE 5)</p> <p>For increase in voltage:</p> $ \% \Delta V_{\text{max}} \leq 6\%$ <p>(see NOTE 6)</p>	Commissioning, maintenance & post fault switching (see NOTE 7)
<p>NOTE 1: $\pm 6\%$ is permissible for 100 ms reduced to $\pm 3\%$ thereafter as per Figure ECC.6.1.7 (1) . If the profile of repetitive voltage change(s) falls within the envelope given in Figure ECC.6.1.7 (1) , the assessment of such voltage change(s) shall be undertaken according to the recommendations for assessment of flicker <u>and</u> shall conform to the planning levels provided for flicker. If any part of the voltage change(s) falls outside the envelope given in Figure ECC.6.1.7(1), the assessment of such voltage changes, repetitive or not, shall be done according to the guidance and limits for RVCs.</p> <p>NOTE 2: No more than 1 event is permitted per day, consisting of up to 4 RVCs, each separated by at least 10 minutes with all switching completed within a two-hour window.</p> <p>NOTE 3: -10% is permissible for 100 ms reduced to -6% until 2 s then reduced to -3% thereafter as per Figure ECC.6.1.7 (2).</p> <p>NOTE 4: $+6\%$ is permissible for 0.8 s from the instant the event begins then reduced to $+3\%$ thereafter as per Figure ECC.6.1.7 (2).</p> <p>NOTE 5: -12% is permissible for 100 ms reduced to -10% until 2 s then reduced to -3% thereafter as per Figure ECC.6.1.7 (3).</p> <p>NOTE 6: $+6\%$ is permissible for 0.8 s from the instant the event begins then reduced to $+3\%$ thereafter as per Figure ECC.6.1.7 (3).</p> <p>NOTE 7: These are examples only. Customers may opt to conform to the limits of another category providing the frequency of occurrence is not expected to exceed the 'Maximum number of occurrence' for the chosen category.</p>				

Table ECC.6.1.7 (a) – Planning levels for RVC

- (b) The voltage change limit is the absolute maximum allowed of either the phase-to-earth voltage change or the phase-to-phase voltage change, whichever is the highest. The limits do not apply to single phasor equivalent voltages, e.g. positive phase sequence (PPS) voltages. For high impedance earthed systems, the maximum phase-to-phase, i.e. line voltage, should be used for assessment.
- (c) The RVCs in Category 2 and 3 should not exceed the limits depicted in the time dependent characteristic shown in Figure ECC.6.1.7 (2) and Figure ECC.6.1.7 (3) respectively. These limits do not apply to: 1) fault clearance operations; or 2) immediate operations in response to fault conditions; or 3) operations relating to post fault system restoration (for the avoidance of doubt this third exception pertains to a fault that is external to the **Users** plant and apparatus).
- (d) Any RVCs permitted in Category 2 and Category 3 should be at least 10 minutes apart.
- (e) The value of $V_{\text{steadystate}}$ should be established immediately prior to the start of a RVC. Following a RVC, the voltage should remain within the relevant envelope, as shown in Figures ECC.6.1.7 (1), ECC.6.1.7 (2), ECC.6.1.7 (3), until a $V_{\text{steadystate}}$ condition has been satisfied.

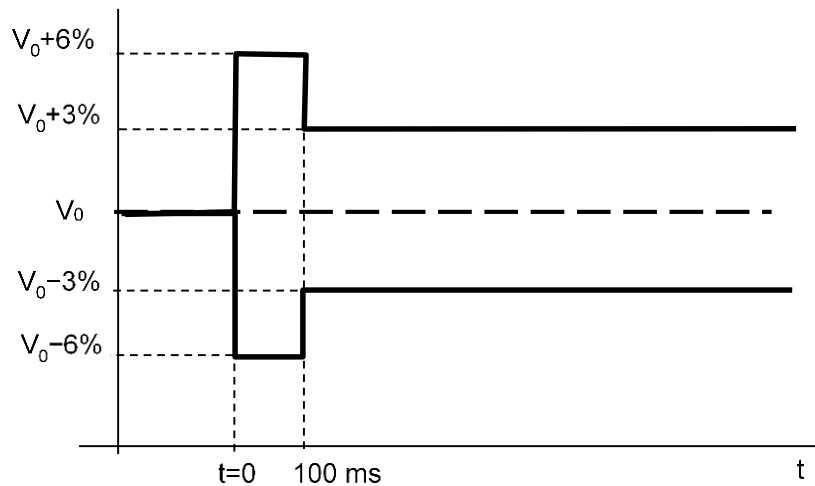

Figure ECC.6.1.7 (1) — Voltage characteristic for frequent events

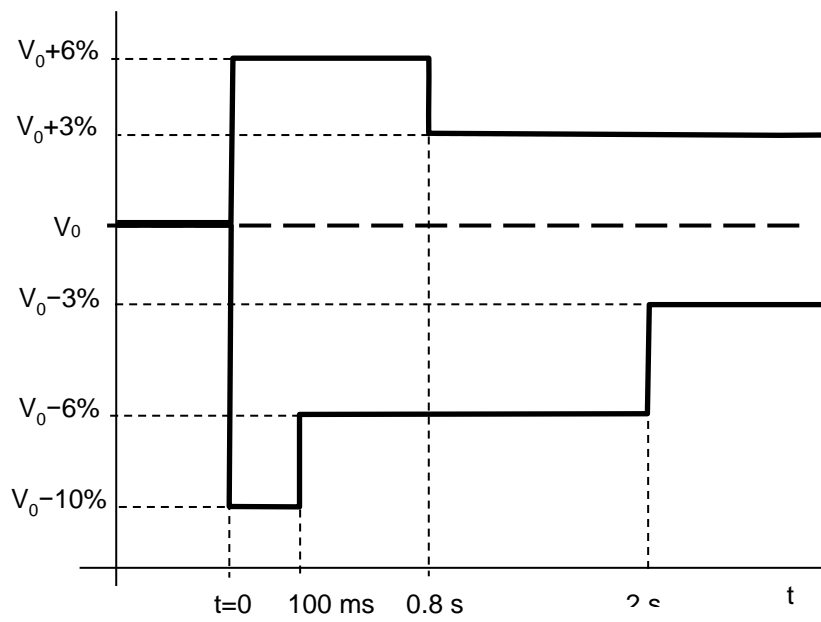

Figure ECC.6.1.7 (2) — Voltage characteristic for infrequent events

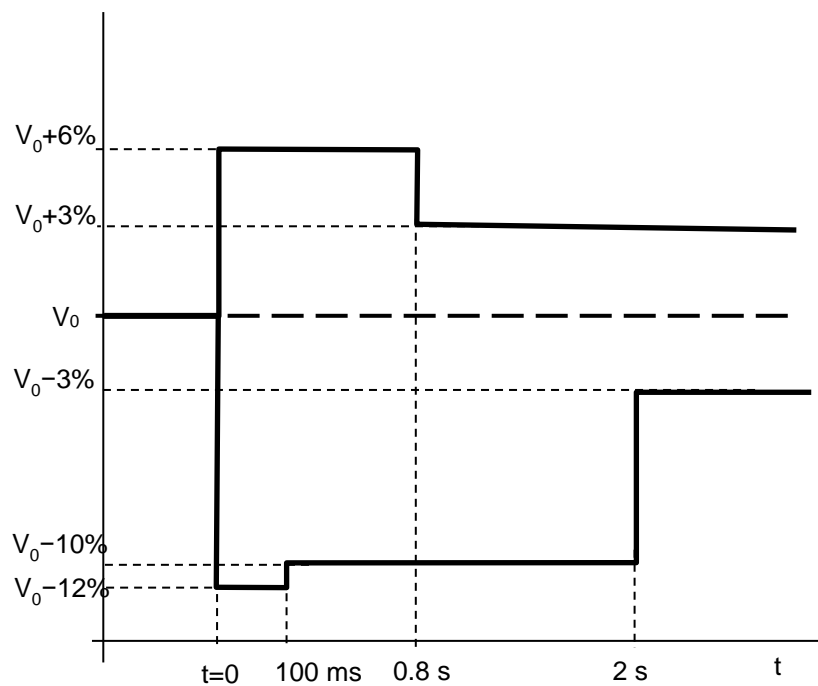

Figure ECC.6.1.7 (3) — Voltage characteristic for very infrequent events

- (f) The voltage change between two steady state voltage conditions should not exceed 3%. (The limit is based on 3% of the nominal voltage of the system (V_n) as measured at the PCC. The step voltage change as measured at the customer's supply terminals or equipment terminals could be greater. For example: The step voltage change limit stated in BS EN 61000-3-3 and BS EN 61000-3-11 is 3.3% when measured at the equipment terminals.)
- (g) The limits apply to voltage changes measured at the **Point of Common Coupling**.
- (h) Category 3 events that are planned should be notified to the Company in advance.
- (i) For connections where voltage changes would constitute a risk to the **National Electricity Transmission System** or, in **The Company's** view, the **System** of any **GB Code User, Bilateral Agreements** may include provision for **The Company** to reasonably limit the number of voltage changes in Category 2 or 3 to a lower number than specified in Table ECC.6.1.7(a) to ensure that the total number of voltage changes at the **Point of Common Coupling** across multiple **Users** remains within the limits of Table ECC.6.1.7(a).
- (j) The planning levels applicable to Flicker Severity Short Term (Pst) and Flicker Severity Long Term (Plt) are set out in Table ECC.6.1.7(b).

Supply system Nominal voltage	Planning level	
	Flicker Severity Short Term (Pst)	Flicker Severity Long Term (Plt)
Up to and including 33 kV	0.9	0.7
66kV and greater	0.8	0.6
NOTE 1: The magnitude of Pst is linear with respect to the magnitude of the voltage changes giving rise to it. NOTE 2: Extreme caution is advised in allowing any excursions of Pst and Plt above the planning level.		

Table ECC.6.7.1(b) — Planning levels for flicker

The values and figures referred to in this paragraph ECC.6.1.7 are derived from Engineering Recommendation P28 Issue 2.

ECC.6.1.8 Voltage fluctuations at a **Point of Common Coupling** with a fluctuating **Load** directly connected to an **Offshore Transmission System** (or in the case of **OTSDUW, OTSDUW Plant and Apparatus**) shall not exceed the limits set out in the **Bilateral Agreement**.

Sub-Synchronous Resonance and Sub-Synchronous Torsional Interaction (SSTI)

ECC.6.1.9 **The Company** shall ensure that **Users' Plant and Apparatus** will not be subject to unacceptable Sub-Synchronous Oscillation conditions as specified in the relevant **License Standards**.

ECC.6.1.10 **The Company** shall ensure where necessary, and in consultation with **Relevant Transmission Licensees** where required, that any relevant site specific conditions applicable at a **User's Connection Site**, including a description of the Sub-Synchronous Oscillation conditions considered in the application of the relevant **License Standards**, are set out in the **User's Bilateral Agreement**.

7

ECC.6.2 Plant and Apparatus relating to Connection Sites and Interface Points and HVDC Interface Points

The following requirements apply to **Plant** and **Apparatus** relating to the **Connection Point** and **OTSDUW Plant and Apparatus** relating to the **Interface Point** (until the **OTSUA Transfer Time**), **HVDC Interface Points** relating to **Remote End HVDC Converters** and **Connection Points** which (except as otherwise provided in the relevant paragraph) each **EU Code User** must ensure are complied with in relation to its **Plant** and **Apparatus** and which in the case of ECC.6.2.2.2.2, ECC.6.2.3.1.1 and ECC.6.2.1.1(b) only, **The Company** must ensure are complied with in relation to **Transmission Plant** and **Apparatus**, as provided in those paragraphs.

ECC.6.2.1 General Requirements

- ECC.6.2.1.1 (a) The design of connections between the **National Electricity Transmission System** and:
- (i) any **Power Generating Module Generating Unit** (other than a **CCGT Unit** or **Power Park Unit**) **HVDC Equipment**, **Power Park Module** or **CCGT Module**, or
 - (ii) any **Network Operator's User System**, or
 - (iii) **Non-Embedded Customers** equipment;
- will be consistent with the **Licence Standards**.

In the case of **OTSDUW**, the design of the **OTSUA's** connections at the **Interface Point** and **Connection Point** will be consistent with **Licence Standards**.

- (b) The **National Electricity Transmission System** (and any **OTSDUW Plant and Apparatus**) at nominal **System** voltages of 132kV and above is/shall be designed to be earthed with an **Earth Fault Factor** of, in England and Wales or **Offshore**, below 1.4 and in Scotland, below 1.5. Under fault conditions the rated **Frequency** component of voltage could fall transiently to zero on one or more phases or, in England and Wales, rise to 140% phase-to-earth voltage, or in Scotland, rise to 150% phase-to-earth voltage. The voltage rise would last only for the time that the fault conditions exist. The fault conditions referred to here are those existing when the type of fault is single or two phase-to-earth.
- (c) For connections to the **National Electricity Transmission System** at nominal **System** voltages of below 132kV the earthing requirements and voltage rise conditions will be advised by **The Company** as soon as practicable prior to connection and in the case of **OTSDUW Plant and Apparatus** shall be advised to **The Company** by the **EU Code User**.

ECC.6.2.1.2 Substation Plant and Apparatus

- (a) The following provisions shall apply to all **Plant** and **Apparatus** which is connected at the voltage of the **Connection Point** (and **OTSDUW Plant and Apparatus** at the **Interface Point**) and which is contained in equipment bays that are within the **Transmission busbar Protection zone** at the **Connection Point**. This includes circuit breakers, switch disconnectors, disconnectors, **Earthing Devices**, power transformers, voltage transformers, reactors, current transformers, surge arresters, bushings, neutral equipment, capacitors, line traps, coupling devices, external insulation and insulation co-ordination devices. Where necessary, this is as more precisely defined in the **Bilateral Agreement**.
- (i) Plant and/or Apparatus in respect of EU Code Users connecting to a new Connection Point (including OTSDUW Plant and Apparatus at the Interface Point)

Each item of such **Plant** and/or **Apparatus** installed in relation to a new **Connection Point** (or **OTSDUW Plant and Apparatus** at the **Interface Point** or **Remote End HVDC Converter Station** at the **HVDC Interface Point**) shall comply with the relevant **Technical Specifications** and any further requirements identified by **The Company**, acting reasonably, to reflect the options to be followed within the **Technical Specifications** and/or to complement if necessary the **Technical Specifications** so as to enable **The Company** to comply with its obligations in

relation to the **National Electricity Transmission System** or the **Relevant Transmission Licensee** to comply with its obligations in relation to its **Transmission System**. This information, including the application dates of the relevant **Technical Specifications**, will be as specified in the **Bilateral Agreement**.

- (ii) EU Code User's Plant and/or Apparatus connecting to an existing Connection Point (including OTSDUW Plant and Apparatus at the Interface Point)

Each new additional and/or replacement item of such **Plant** and/or **Apparatus** installed in relation to a change to an existing **Connection Point** (or **OTSDUW Plant and Apparatus** at the **Interface Point** and **Connection Point** or **Remote End HVDC Converter Stations** at the **HVDC Interface Point**)—shall comply with the standards/specifications applicable when the change was designed, or such other standards/specifications as necessary to ensure that the item of **Plant** and/or **Apparatus** is reasonably fit for its intended purpose having due regard to the obligations of **The Company**, the relevant **User** the **Relevant Transmission Licensee** under their respective **Licences**. Where appropriate this information, including the application dates of the relevant standards/specifications, will be as specified in the varied **Bilateral Agreement**.

- (iii) Used Plant and/or Apparatus being moved, re-used or modified

If, after its installation, any such item of **Plant** and/or **Apparatus** is subsequently:

- moved to a new location; or
- used for a different purpose; or
- otherwise modified;

then the standards/specifications as described in (i) or (ii) above as applicable will apply as appropriate to such **Plant** and/or **Apparatus**, which must be reasonably fit for its intended purpose having due regard to the obligations of **The Company**, the relevant **User** and the **Relevant Transmission Licensee** under their respective **Licences**.

- (b) **The Company** shall at all times maintain a list of those **Technical Specifications** and additional requirements which might be applicable under this ECC.6.2.1.2 and which may be referenced by **The Company** in the **Bilateral Agreement**. **The Company** shall provide a copy of the list upon request to any **EU Code User**. **The Company** shall also provide a copy of the list to any **EU Code User** upon receipt of an application form for a **Bilateral Agreement** for a new **Connection Point**.
- (c) Where the **EU Code User** provides **The Company** with information and/or test reports in respect of **Plant** and/or **Apparatus** which the **EU Code User** reasonably believes demonstrate the compliance of such items with the provisions of a **Technical Specification** then **The Company** shall promptly and without unreasonable delay give due and proper consideration to such information.
- (d) **Plant** and **Apparatus** shall be designed, manufactured and tested in premises with an accredited certificate in accordance with the quality assurance requirements of the relevant standard in the BS EN ISO 9000 series (or equivalent as reasonably approved by **The Company**) or in respect of test premises which do not include a manufacturing facility premises with an accredited certificate in accordance with BS EN 45001.
- (e) Each connection between a **User** and the **National Electricity Transmission System** must be controlled by a circuit-breaker (or circuit breakers) capable of interrupting the maximum short circuit current at the point of connection. The **Seven Year Statement** gives values of short circuit current and the rating of **Transmission** circuit breakers at existing and committed **Connection Points** for future years.

- (f) Each connection between a **Generator** undertaking **OTSDUW** or an **Onshore Transmission Licensee**, must be controlled by a circuit breaker (or circuit breakers) capable of interrupting the maximum short circuit current at the **Transmission Interface Point**. The **Seven Year Statement** gives values of short circuit current and the rating of **Transmission** circuit breakers at existing and committed **Transmission Interface Points** for future years.

ECC.6.2.2 Requirements at **Connection Points** or, in the case of **OTSDUW** at **Interface Points** that relate to **Generators** or **OTSDUW Plant and Apparatus**

ECC.6.2.2.1 Not Used.

ECC.6.2.2.2 **Power Generating Module, OTSDUW Plant and Apparatus, HVDC Equipment and Power Station Protection Arrangements**

ECC.6.2.2.2.1 Minimum Requirements

ECC.6.2.2.2.1.1 **Protection of Power Generating Modules** (other than **Power Park Units**), **HVDC Equipment, OTSDUW Plant and Apparatus** and their connections to the **National Electricity Transmission System** shall meet the requirements given below. These are necessary to reduce the impact on the **National Electricity Transmission System** of faults on **OTSDUW Plant and Apparatus** circuits or circuits owned by **Generators** (including **DC Connected Power Park Modules**) or **HVDC System Owners**.

ECC.6.2.2.2.1.2 **Restoration Contractors** shall, if required by a **Restoration Plan**, have the ability to switch:-

- a) From the normal to the alternative **Protection** settings on their **Plant and Apparatus** and:-
- b) From the alternative to the normal **Protection** settings whilst their **Plant** remains in service.

Any alternative **Protection** settings shall be included in the **Restoration Plan**. Normal and alternative **Protection** settings shall be agreed between **The Company** and/or **Relevant Transmission Licensee** and/or **Network Operator** as part of developing a **Restoration Plan**.

ECC.6.2.2.2.2 Fault Clearance Times

- (a) The required fault clearance time for faults on the **Generator's** (including **DC Connected Power Park Modules**) or **HVDC System Owner's** equipment directly connected to the **National Electricity Transmission System** or **OTSDUW Plant and Apparatus** and for faults on the **National Electricity Transmission System** directly connected to the **EU Generator** (including **DC Connected Power Park Modules**) or **HVDC System Owner's** equipment or **OTSDUW Plant and Apparatus**, from fault inception to the circuit breaker arc extinction, shall be set out in the **Bilateral Agreement**. The fault clearance time specified in the **Bilateral Agreement** shall not be shorter than the durations specified in (i), (ii) and (iii) below:

- (i) 80ms for connections operating at a nominal voltage of greater than 300kV
- (ii) 100ms for connections operating at a nominal voltage of greater than 132kV and up to 300kV
- (iii) 120ms for connections operating at a nominal voltage of 132kV and below

but this shall not prevent the **User** or **The Company** or the **Relevant Transmission Licensee** or the **EU Generator** (including in respect of **OTSDUW Plant and Apparatus** and **DC Connected Power Park Modules**) from selecting a shorter fault clearance time on their own **Plant and Apparatus** provided **Discrimination** is achieved.

A longer fault clearance time may be specified in the **Bilateral Agreement** for faults on the **National Electricity Transmission System**. A longer fault clearance time for faults on the **EU Generator** or **HVDC System Owner's** equipment or **OTSDUW Plant and Apparatus** may be agreed with **The Company** in accordance with the terms of the **Bilateral Agreement** but only if **System** requirements, in **The Company's** view, permit. The probability that the fault clearance time stated in the **Bilateral Agreement** will be exceeded by any given fault, must be less than 2%.

- (b) In the event that the required fault clearance time is not met as a result of failure to operate on the **Main Protection System(s)** provided, the **Generators** or **HVDC System Owners** or **Generators** in the case of **OTSDUW Plant and Apparatus** shall, except as specified below provide **Independent Back-Up Protection**. The **Relevant Transmission Licensee** will also provide **Back-Up Protection** and the **Relevant Transmission Licensee's** and the **User's Back-Up Protections** will be co-ordinated so as to provide **Discrimination**.

On a **Power Generating Module** (other than a **Power Park Unit**), **HVDC Equipment** or **OTSDUW Plant and Apparatus** and connected to the **National Electricity Transmission System** operating at a nominal voltage of greater than 132kV and where two **Independent Main Protections** are provided to clear faults on the **HV Connections** within the required fault clearance time, the **Back-Up Protection** provided by **EU Generators** (including in respect of **OTSDUW Plant and Apparatus** and **DC Connected Power Park Modules**) and **HVDC System Owners** shall operate to give a fault clearance time of no longer than 300ms at the minimum infeed for normal operation for faults on the **HV Connections**. Where two **Independent Main Protections** are installed the **Back-Up Protection** may be integrated into one (or both) of the **Independent Main Protection** relays.

On a **Power Generating Module** (other than a **Power Park Unit**), **HVDC Equipment** or **OTSDUW Plant and Apparatus** and connected to the **National Electricity Transmission System** at 132 kV and below and where only one **Main Protection** is provided to clear faults on the **HV Connections** within the required fault clearance time, the **Independent Back-Up Protection** provided by the **Generator** (including in respect of **OTSDUW Plant and Apparatus** and **DC Connected Power Park Modules**) and the **HVDC System Owner** shall operate to give a fault clearance time of no longer than 300ms at the minimum infeed for normal operation for faults on the **HV Connections**.

A **Power Generating Module** (other than a **Power Park Unit**), **HVDC Equipment** or **OTSDUW Plant and Apparatus**) with **Back-Up Protection** or **Independent Back-Up Protection** will also be required to withstand, without tripping, the loading incurred during the clearance of a fault on the **National Electricity Transmission System** by breaker fail **Protection** at a nominal voltage of greater than 132kV or of a fault cleared by **Back-Up Protection** where the **EU Generator** (including in the case of **OTSDUW Plant and Apparatus** or **DC Connected Power Park Module**) or **HVDC System** is connected at 132kV and below. This will permit **Discrimination** between the **Generator** in respect of **OTSDUW Plant and Apparatus** or **DC Connected Power Park Modules** or **HVDC System Owners' Back-Up Protection** or **Independent Back-Up Protection** and the **Back-Up Protection** provided on the **National Electricity Transmission System** and other **Users' Systems**.

- (c) When the **Power Generating Module** (other than **Power Park Units**), or the **HVDC Equipment** or **OTSDUW Plant and Apparatus** is connected to the **National Electricity Transmission System** operating at a nominal voltage of greater than 132kV, and in Scotland and **Offshore** also at 132kV, and a circuit breaker is provided by the **Generator** (including in respect of **OTSDUW Plant and Apparatus** or **DC Connected Power Park Modules**) or the **HVDC System** owner, or the **Relevant Transmission Licensee**, as the case may be, to interrupt fault current interchange with the **National Electricity Transmission System**, or **Generator's System**, or **HVDC System Owner's System**, as the case may be, circuit breaker fail **Protection** shall be provided by the **Generator** (including in respect of **OTSDUW Plant and Apparatus** or **DC Connected Power Park Modules**) or **HVDC System-Owner**, or the **Relevant Transmission Licensee**, as the case may be, on this circuit breaker. In the event, following operation of a **Protection** system, of a failure to interrupt fault current by these circuit-breakers within the **Fault Current Interruption Time**, the circuit breaker fail **Protection** is required to initiate tripping of all the necessary electrically adjacent circuit-breakers so as to interrupt the fault current within the next 200ms.
- (d) The target performance for the **System Fault Dependability Index** shall be not less than 99%. This is a measure of the ability of **Protection** to initiate successful tripping of circuit breakers which are associated with the faulty item of **Apparatus**.

ECC.6.2.2.3 Equipment including **Protection** equipment to be provided

The **Relevant Transmission Licensee** shall specify the **Protection** schemes and settings necessary to protect the **National Electricity Transmission System**, taking into account the characteristics of the **Power Generating Module** or **HVDC Equipment**.

The protection schemes needed for the **Power Generating Module** or **HVDC Equipment** and the **National Electricity Transmission System** as well as the settings relevant to the **Power Generating Module** and/or **HVDC Equipment** shall be coordinated and agreed between **The Company** and the **EU Generator** or **HVDC System Owner**. The agreed **Protection** schemes and settings will be specified in the **Bilateral Agreement**.

The protection schemes and settings for internal electrical faults must not prevent the **Power Generating Module** or **HVDC Equipment** from satisfying the requirements of the Grid Code although **EU Generators** should be aware of the requirements of ECC.6.3.13.1. ;

electrical **Protection** of the **Power Generating Module** or **HVDC Equipment** shall take precedence over operational controls, taking into account the security of the **National Electricity Transmission System** and the health and safety of personnel, as well as mitigating any damage to the **Power Generating Module** or **HVDC Equipment**.

ECC.6.2.2.3.1 Protection of Interconnecting Connections

The requirements for the provision of **Protection** equipment for interconnecting connections will be specified in the **Bilateral Agreement**. In this **ECC** the term "interconnecting connections" means the primary conductors from the current transformer accommodation on the circuit side of the circuit breaker to the **Connection Point** or the primary conductors from the current transformer accommodation on the circuit side of the **OTSDUW Plant and Apparatus** of the circuit breaker to the **Transmission Interface Point**.

ECC.6.2.2.3.2 Circuit-breaker fail Protection

The **EU Generator** or **HVDC System Owner** will install circuit breaker fail **Protection** equipment in accordance with the requirements of the **Bilateral Agreement**. The **EU Generator** or **HVDC System Owner** will also provide a back-trip signal in the event of loss of air from its pressurised head circuit breakers, during the **Power Generating Module** (other than a **CCGT Unit** or **Power Park Unit**) or **HVDC Equipment** run-up sequence, where these circuit breakers are installed.

ECC.6.2.2.3.3 Loss of Excitation

The **EU Generator** must provide **Protection** to detect loss of excitation in respect of each of its **Generating Units** within a **Synchronous Power Generating Module** to initiate a **Generating Unit** trip.

ECC.6.2.2.3.4 Pole-Slipping Protection

Where, in **The Company's** reasonable opinion, **System** requirements dictate, **The Company** will specify in the **Bilateral Agreement** a requirement for **EU Generators** to fit pole-slipping **Protection** on their **Generating Units** within each **Synchronous Power Generating Module**.

ECC.6.2.2.3.5 Signals for Tariff Metering

EU Generators and **HVDC System Owners** will install current and voltage transformers supplying all tariff meters at a voltage to be specified in, and in accordance with, the **Bilateral Agreement**.

ECC.6.2.2.3.6 Commissioning of Protection Systems

No **EU Generator** or **HVDC System Owner** equipment shall be energised until the **Protection** settings have been finalised. The **EU Generator** or **HVDC System Owner** shall agree with **The Company** (in coordination with the **Relevant Transmission Licensee**) and carry out a combined commissioning programme for the **Protection** systems, and generally, to a minimum standard as specified in the **Bilateral Agreement**.

ECC.6.2.2.4 Work on Protection Equipment

No busbar **Protection**, mesh corner **Protection**, circuit-breaker fail **Protection** relays, AC or DC wiring (other than power supplies or DC tripping associated with the **Power Generating Module**, **HVDC Equipment** itself) may be worked upon or altered by the **EU Generator** or **HVDC System Owner** personnel in the absence of a representative of the **Relevant Transmission Licensee** or written authority from the **Relevant Transmission Licensee** to perform such work or alterations in the absence of a representative of the **Relevant Transmission Licensee**.

ECC.6.2.2.5 Relay Settings

Protection and relay settings will be co-ordinated (both on connection and subsequently) across the **Connection Point** in accordance with the **Bilateral Agreement** and in relation to **OTSDUW Plant and Apparatus**, across the **Interface Point** in accordance with the **Bilateral Agreement** to ensure effective disconnection of faulty **Apparatus**.

ECC.6.2.2.6 Changes to Protection Schemes and HVDC System Control Modes

ECC.6.2.2.6.1 Any subsequent alterations to the protection settings (whether by **The Company**, the **Relevant Transmission Licensee**, the **EU Generator**, or the **HVDC System Owner**) shall be agreed between **The Company** (in co-ordination with the **Relevant Transmission Licensee**) and the **EU Generator** or **HVDC System Owner** in accordance with the Grid Code (ECC.6.2.2.5). No alterations are to be made to any protection schemes unless agreement has been reached between **The Company**, the **Relevant Transmission Licensee**, the **EU Generator** or **HVDC System Owner**.

ECC.6.2.2.6.2 The parameters of different control modes of the **HVDC System** shall be able to be changed in the **HVDC Converter Station**, if required by **The Company** in coordination with the **Relevant Transmission Licensee** and in accordance with ECC.6.2.2.6.4.

ECC.6.2.2.6.3 Any change to the schemes or settings of parameters of the different control modes and protection of the **HVDC System** including the procedure shall be agreed with **The Company** in coordination with the **Relevant Transmission Licensee** and the **HVDC System Owner**.

ECC.6.2.2.6.4 The control modes and associated set points shall be capable of being changed remotely, as specified by **The Company** in coordination with the **Relevant Transmission Licensee**.

ECC.6.2.2.7 Control Schemes and Settings

- ECC.6.2.2.7.1 The schemes and settings of the different control devices on the **Power Generating Module** and **HVDC Equipment** that are necessary for **Transmission System** stability and for taking emergency action shall be agreed with **The Company** in coordination with the **Relevant Transmission Licensee** and the **EU Generator** or **HVDC System Owner**. **Restoration Contractors** shall have the ability to switch from alternative control schemes and settings on their **Plant** and **Apparatus** whilst remaining in service if they are required to satisfy their obligations in a **Restoration Plan**. Changes to any control schemes and settings shall be agreed between **The Company** and/or **Relevant Transmission Licensee** and/or **Network Operator** as part of developing a **Restoration Plan** which shall be in accordance with the requirements of ECC.6.2.2.6.
- ECC.6.2.2.7.2 Subject to the requirements of ECC.6.2.2.7.1 any changes to the schemes and settings, defined in ECC.6.2.2.7.1, of the different control devices of the **Power Generating Module** or **Restoration Contractor** or **HVDC Equipment** shall be coordinated and agreed between the **Relevant Transmission Licensee**, the **EU Generator**, **Restoration Contractor** and **HVDC System Owner**.
- ECC.6.2.2.8 Ranking of Protection and Control
- ECC.6.2.2.8.1 **The Company** in coordination with **Relevant Transmission Licensees**, shall agree and coordinate the protection and control devices of **EU Generators Plant** and **Apparatus** in accordance with the following general priority ranking (from highest to lowest):
- (i) The interface between the **National Electricity Transmission System** and the **Power Generating Module** or **HVDC Equipment Protection** equipment;
 - (ii) frequency control (active power adjustment);
 - (iii) power restriction; and
 - (iv) power gradient constraint;
- ECC.6.2.2.8.2 A control scheme, specified by the **HVDC System Owner** consisting of different control modes, including the settings of the specific parameters, shall be coordinated and agreed between **The Company** in coordination with the **Relevant Transmission Licensee** and the **HVDC System Owner**. These details would be specified in the **Bilateral Agreement**.
- ECC.6.2.2.8.3 **The Company** in coordination with **Relevant Transmission Licensees**, shall agree and coordinate the protection and control devices of **HVDC System Owners Plant** and **Apparatus** in accordance with the following general priority ranking (from highest to lowest)
- (i) The interface between the **National Electricity Transmission System** and **HVDC System Protection** equipment;
 - (ii) **Active Power** control for emergency assistance
 - (iii) automatic remedial actions as specified in ECC.6.3.6.1.2.5
 - (iv) **Limited Frequency Sensitive Mode** (LFSM) of operation;
 - (v) **Frequency Sensitive Mode** of operation and **Frequency** control; and
 - (vi) power gradient constraint.
- ECC.6.2.2.9 Synchronising
- ECC.6.2.2.9.1 For any **Power Generating Module** directly connected to the **National Electricity Transmission System** or **Type D Power Generating Module**, synchronisation shall be performed by the **EU Generator** only after instruction by **The Company** in accordance with the requirements of BC.2.5.2.
- ECC.6.2.2.9.2 Each **Power Generating Module** directly connected to the **National Electricity Transmission System** or **Type D Power Generating Module** shall be equipped with the necessary synchronisation facilities. Synchronisation shall be possible within the range of frequencies specified in ECC.6.1.2.

ECC.6.2.2.9.3 The requirements for synchronising equipment shall be specified in accordance with the requirements in the **Electrical Standards** listed in the annex to the **General Conditions**. The synchronisation settings shall include the following elements below. Any variation to these requirements shall be pursuant to the terms of the **Bilateral Agreement**.

- (a) voltage
- (b) **Frequency**
- (c) phase angle range
- (d) phase sequence
- (e) deviation of voltage and **Frequency**

ECC.6.2.2.9.4 **HVDC Equipment** shall be required to satisfy the requirements of ECC.6.2.2.9.1 – ECC.6.2.2.9.3. In addition, unless otherwise specified by **The Company**, during the synchronisation of a **DC Connected Power Park Module** to the **National Electricity Transmission System**, any **HVDC Equipment** shall have the capability to limit any steady state voltage changes to the limits specified within ECC.6.1.7 or ECC.6.1.8 (as applicable) which shall not exceed 5% of the pre-synchronisation voltage. **The Company** in coordination with the **Relevant Transmission Licensee** shall specify any additional requirements for the maximum magnitude, duration and measurement of the voltage transients over and above those defined in ECC.6.1.7 and ECC.6.1.8 in the **Bilateral Agreement**.

ECC.6.2.2.9.5 **EU Generators** in respect of **DC Connected Power Park Modules** shall also provide output synchronisation signals specified by **The Company** in co-ordination with the **Relevant Transmission Licensee**.

ECC.6.2.2.9.6 In addition to the requirements of ECC.6.2.2.9.1 to ECC.6.2.2.9.5, **EU Generators** and **HVDC System Owners** should also be aware of the requirements of ECC.6.5.10 relating to busbar voltage

ECC.6.2.2.9.10 HVDC Parameters and Settings

ECC.6.2.2.9.10.1 The parameters and settings of the main control functions of an **HVDC System** shall be agreed between the **HVDC System** owner and **The Company**, in coordination with the **Relevant Transmission Licensee**. The parameters and settings shall be implemented within such a control hierarchy that makes their modification possible if necessary. Those main control functions are at least:

- (b) **Frequency Sensitive Modes** (FSM, LFSM-O, LFSM-U);
- (c) **Frequency** control, if applicable;
- (d) **Reactive Power** control mode, if applicable;
- (e) power oscillation damping capability;
- (f) subsynchronous torsional interaction damping capability,.

ECC.6.2.2.11 Automatic Reconnection

ECC.6.2.2.11.1 **EU Generators** in respect of **Type A, Type B, Type C** and **Type D Power Generating Modules** (including **DC Connected Power Park Modules**) which have signed a **CUSC Contract** with **The Company** are not permitted to automatically reconnect to the **Total System** without instruction from **The Company**. **The Company** will issue instructions for reconnection or re-synchronisation in accordance with the requirements of BC2.5.2. Where synchronising is permitted in accordance with BC2.5.2, the voltage and frequency at the **Grid Entry Point** or **User System Entry Point** shall be within the limits defined in ECC.6.1.2 and ECC.6.1.4 and the ramp rate limits pursuant to BC1.A.1.1. For the avoidance of doubt this requirement does not apply to **EU Generators** who are not required to satisfy the requirements of the Balancing Codes.

ECC.6.2.2.12 Automatic Disconnection

ECC.6.2.2.12.1 No **Power Generating Module** or **HVDC Equipment** shall disconnect within the frequency range or voltage range defined in ECC.6.1.2 and ECC.6.1.4.

ECC.6.2.2.13 Special Provisions relating to Power Generating Modules embedded within Industrial Sites which supply electricity as a bi-product of their industrial process

ECC.6.2.2.13.1 **Generators** in respect of **Power Generating Modules** which form part of an industrial network, where the **Power Generating Module** is used to supply critical loads within the industrial process shall be permitted to operate isolated from the **Total System** if agreed with **The Company** in the **Bilateral Agreement**.

ECC.6.2.2.13.2 Except for the requirements of ECC.6.3.3 and ECC.6.3.7.1, **Power Generating Modules** which are embedded within industrial sites are not required to satisfy the requirements of ECC.6.3.6.2.1 and ECC.6.3.9. In this case this exception would only apply to **Power Generating Modules** on industrial sites used for combined heat and power production which are embedded in the network of an industrial site where all the following criteria are met.

- (a) The primary purpose of these sites is to produce heat for production processes of the industrial site concerned,
- (b) Heat and power generation is inextricably interlinked, that is to say any change to heat generation results inadvertently in a change of active power generating and vice versa.
- (c) The **Power Generating Modules** are of **Type A, Type B or Type C**.
- (d) Combined heat and power generating facilities shall be assessed on the basis of their electrical **Maximum Capacity**.

ECC.6.2.3 Requirements at EU Grid Supply Points relating to Network Operators and Non-Embedded Customers

ECC.6.2.3.1 Protection Arrangements for EU Code Users in respect of Network Operators and Non-Embedded Customers

ECC.6.2.3.1.1 **Protection** arrangements for **EU Code Users** in respect of **Network Operators** and **Non-Embedded Customers User Systems** directly connected to the **National Electricity Transmission System**, shall meet the requirements given below:

Fault Clearance Times

- (a) The required fault clearance time for faults on **Network Operator** and **Non-Embedded Customer** equipment directly connected to the **National Electricity Transmission System**, and for faults on the **National Electricity Transmission System** directly connected to the **Network Operator's** or **Non-Embedded Customer's** equipment, from fault inception to the circuit breaker arc extinction, shall be set out in each **Bilateral Agreement**. The fault clearance time specified in the **Bilateral Agreement** shall not be shorter than the durations specified in (i), (ii) and (iii) below:
 - (i) 80ms for connections operating at a nominal voltage of greater than 300kV
 - (ii) 100ms for connections operating at a nominal voltage of greater than 132kV and up to 300kV
 - (iii) 120ms for connections operating at a nominal voltage of greater than 132kV and below

but this shall not prevent the **User** or **The Company** or **Relevant Transmission Licensee** from selecting a shorter fault clearance time on its own **Plant** and **Apparatus** provided **Discrimination** is achieved.

For the purpose of establishing the **Protection** requirements in accordance with ECC.6.2.3.1.1 only, the point of connection of the **Network Operator** or **Non-Embedded Customer** equipment to the **National Electricity Transmission System** shall be deemed to be the low voltage busbars at an **EU Grid Supply Point**, irrespective of the ownership of the equipment at the **EU Grid Supply Point**.

A longer fault clearance time may be specified in the **Bilateral Agreement** for faults on the **National Electricity Transmission System**. A longer fault clearance time for faults on the **Network Operator** and **Non-Embedded Customers** equipment may be agreed with **The Company** in accordance with the terms of the **Bilateral Agreement** but only if **System** requirements in **The Company's** view permit. The probability that the fault clearance time stated in the **Bilateral Agreement** will be exceeded by any given fault must be less than 2%.

- (b) (i) For the event of failure of the **Protection** systems provided to meet the above fault clearance time requirements, **Back-Up Protection** shall be provided by the **Network Operator** or **Non-Embedded Customer** as the case may be.
 - (ii) The **Relevant Transmission Licensee** will also provide **Back-Up Protection**, which will result in a fault clearance time longer than that specified for the **Network Operator** or **Non-Embedded Customer Back-Up Protection** so as to provide **Discrimination**.
 - (iii) For connections with the **National Electricity Transmission System** at 132kV and below, it is normally required that the **Back-Up Protection** on the **National Electricity Transmission System** shall discriminate with the **Network Operator** or **Non-Embedded Customer's Back-Up Protection**.
 - (iv) For connections with the **National Electricity Transmission System** operating at a nominal voltage greater than 132kV, the **Back-Up Protection** will be provided by the **Network Operator** or **Non-Embedded Customer**, as the case may be, with a fault clearance time not longer than 300ms for faults on the **Network Operator's** or **Non-Embedded Customer's Apparatus**.
 - (v) Such **Protection** will also be required to withstand, without tripping, the loading incurred during the clearance of a fault on the **National Electricity Transmission System** by breaker fail **Protection** operating at a nominal voltage of greater than 132kV. This will permit **Discrimination** between **Network Operator's Back-Up Protection** or **Non-Embedded Customer's Back-Up Protection**, as the case may be, and **Back-Up Protection** provided on the **National Electricity Transmission System** and other **User Systems**. The requirement for and level of **Discrimination** required will be specified in the **Bilateral Agreement**.
- (c) (i) Where the **Network Operator** or **Non-Embedded Customer** is connected to part of the **National Electricity Transmission System** operating at a nominal voltage greater than 132kV and in Scotland also at 132kV, and a circuit breaker is provided by the **Network Operator** or **Non-Embedded Customer**, or the **Relevant Transmission Licensee**, as the case may be, to interrupt the interchange of fault current with the **National Electricity Transmission System** or the **System** of the **Network Operator** or **Non-Embedded Customer**, as the case may be, circuit breaker fail **Protection** will be provided by the **Network Operator** or **Non-Embedded Customer**, or the **Relevant Transmission Licensee**, as the case may be, on this circuit breaker.
 - (ii) In the event, following operation of a **Protection** system, of a failure to interrupt fault current by these circuit-breakers within the **Fault Current Interruption Time**, the circuit breaker fail **Protection** is required to initiate tripping of all the necessary electrically adjacent circuit-breakers so as to interrupt the fault current within the next 200ms.
- (d) The target performance for the **System Fault Dependability Index** shall be not less than 99%. This is a measure of the ability of **Protection** to initiate successful tripping of circuit breakers which are associated with the faulty items of **Apparatus**.

ECC.6.2.3.2 Fault Disconnection Facilities

- (a) Where no **Transmission** circuit breaker is provided at the **User's** connection voltage, the **User** must provide **The Company** with the means of tripping all the **User's** circuit breakers necessary to isolate faults or **System** abnormalities on the **National Electricity Transmission System**. In these circumstances, for faults on the **User's System**, the **User's Protection** should also trip higher voltage **Transmission** circuit breakers. These tripping facilities shall be in accordance with the requirements specified in the **Bilateral Agreement**.
- (b) **The Company** may require the installation of a **System to Generator Operational Intertripping Scheme** in order to enable the timely restoration of circuits following power **System** fault(s). These requirements shall be set out in the relevant **Bilateral Agreement**.

ECC.6.2.3.3 Automatic Switching Equipment

Where automatic reclosure of **Transmission** circuit breakers is required following faults on the **User's System**, automatic switching equipment shall be provided in accordance with the requirements specified in the **Bilateral Agreement**.

ECC.6.2.3.4 Relay Settings

Protection and relay settings will be co-ordinated (both on connection and subsequently) across the **Connection Point** in accordance with the **Bilateral Agreement** to ensure effective disconnection of faulty **Apparatus**.

ECC.6.2.3.5 Work on Protection equipment

Where a **Transmission Licensee** owns the busbar at the **Connection Point**, no busbar **Protection**, mesh corner **Protection** relays, AC or DC wiring (other than power supplies or DC tripping associated with the **Network Operator** or **Non-Embedded Customer's Apparatus** itself) may be worked upon or altered by the **Network Operator** or **Non-Embedded Customer** personnel in the absence of a representative of the **Relevant Transmission Licensee** or written authority from the **Relevant Transmission Licensee** to perform such work or alterations in the absence of a representative of the **Relevant Transmission Licensee**.

ECC.6.2.3.6 Equipment including Protection equipment to be provided

The Company in coordination with the **Relevant Transmission Licensee** shall specify and agree the **Protection** schemes and settings at each **EU Grid Supply Point** required to protect the **National Electricity Transmission System** in accordance with the characteristics of the **Network Operator's** or **Non Embedded Customer's System**. **The Company** in coordination with the **Relevant Transmission Licensee** and the **Network Operator** or **Non Embedded Customer** shall agree on the protection schemes and settings in respect of the busbar protection zone in respect of each **EU Grid Supply Point**.

Protection of the **Network Operator's** or **Non Embedded Customer's System** shall take precedence over operational controls whilst respecting the security of the **National Electricity Transmission System** and the health and safety of staff and the public.

ECC.6.2.3.6.1 Protection of Interconnecting Connections

The requirements for the provision of **Protection** equipment for interconnecting connections will be specified in the **Bilateral Agreement**.

ECC.6.2.3.7 Changes to Protection Schemes

ECC.6.2.3.7.1 At EU Grid Supply Points

Any alterations to the busbar protection settings at the **EU Grid Supply Point** (whether by **The Company**, the **Relevant Transmission Licensee**, the **Network Operator** or the **Non Embedded Customer**) shall be agreed between **The Company** (in co-ordination with the **Relevant Transmission Licensee**) and the **Network Operator** or **Non Embedded Customer** in accordance with the Grid Code (ECC.6.2.3.4). No alterations are to be made to

any busbar protection schemes unless agreement has been reached between **The Company**, the **Relevant Transmission Licensee**, the **Network Operator** or **Non Embedded Customer**.

No **Network Operator** or **Non-Embedded Customer** equipment shall be energised until the **Protection** settings have been agreed prior to commissioning. The **Network Operator** or **Non-Embedded Customer** shall agree with **The Company** (in coordination with the **Relevant Transmission Licensee**) and carry out a combined commissioning programme for the **Protection** systems, and generally, to a minimum standard as specified in the **Bilateral Agreement**.

ECC.6.2.3.7.2 Network Operators Systems

Network Operators shall, if required in a **Restoration Plan**, have the ability to switch:-

- a) From the normal to the alternative **Protection** settings on their **Plant** and **Apparatus**; and:-
- b) From the alternative to the normal **Protection** settings whilst their **Plant** remains in service,

Any alternative **Protection** settings shall be included in the **Restoration Plan**. Normal and alternative **Protection** settings shall be agreed between **The Company** and the **Network Operator** as part of developing a **Restoration Plan**.

ECC.6.2.3.8 Control Requirements

ECC.6.2.3.8.1 **The Company** in coordination with the **Relevant Transmission Licensee** and the **Network Operator** or **Non Embedded Customer** shall agree on the control schemes and settings at each **EU Grid Supply Point** of the different control devices of the **Network Operator's** or **Non Embedded Customer's System** relevant for security of the **National Electricity Transmission System**. Such requirements would be pursuant to the terms of the **Bilateral Agreement** which shall also cover at least the following elements:

- (a) Isolated (**National Electricity Transmission System**) operation;
- (b) Damping of oscillations;
- (c) Disturbances to the **National Electricity Transmission System**;
- (d) Automatic switching to emergency supply and restoration to normal topology;
- (e) Automatic circuit breaker re-closure (on 1-phase faults).

ECC.6.2.3.8.2 Subject to the requirements of ECC.6.2.3.8.1, any changes to the schemes and settings, defined in ECC.6.2.3.8.1 of the different control devices of the **Network Operator's** or **Non-Embedded Customer's System** at the **EU Grid Supply Point** shall be coordinated and agreed between **The Company**, the **Relevant Transmission Licensee**, the **Network Operator** or **Non Embedded Customer**. **Network Operators** shall have the ability to switch between alternative control settings on their **Plant** and **Apparatus** if they are required to do so to be able to satisfy their obligations of a **Restoration Plan**. Any alternative control settings shall be included in the **Restoration Plan**.

ECC.6.2.3.9 Ranking of Protection and Control

ECC.6.2.3.9.1 The **Network Operator** or the **Non Embedded Customer** who owns or operates an **EU Grid Supply Point** shall set the **Protection** and control devices of its **System**, in compliance with the following priority ranking, organised in decreasing order of importance:

- (a) **National Electricity Transmission System Protection**;
- (b) **Protection** equipment at each **EU Grid Supply Point**;
- (c) **Frequency** control (**Active Power** adjustment);

(d) Power restriction.

ECC.6.2.3.10 Synchronising

ECC.6.2.3.10.1 Each **Network Operator** or **Non Embedded Customer** at each **EU Grid Supply Point** shall be capable of synchronisation within the range of frequencies specified in ECC.6.1.2 unless otherwise agreed with **The Company**.

ECC.6.2.3.10.2 **The Company** and the **Network Operator** or **Non Embedded Customer** shall agree on the settings of the synchronisation equipment at each **EU Grid Supply Point** prior to the **Completion Date**. **The Company** and the relevant **Network Operator** or **Non-Embedded Customer** shall agree the synchronisation settings which shall include the following elements.

- (a) Voltage;
- (b) **Frequency**;
- (c) phase angle range;
- (d) deviation of voltage and **Frequency**.

ECC.6.3 GENERAL POWER GENERATING MODULE, OTSDUW AND HVDC EQUIPMENT REQUIREMENTS

ECC.6.3.1 This section sets out the technical and design criteria and performance requirements for **Power Generating Modules** (which includes **Electricity Storage Modules**) and **HVDC Equipment** (whether directly connected to the **National Electricity Transmission System** or **Embedded**) and (where provided in this section) **OTSDUW Plant and Apparatus** which each **Generator** or **HVDC System Owner** must ensure are complied with in relation to its **Power Generating Modules**, **HVDC Equipment** and **OTSDUW Plant and Apparatus**. References to **Power Generating Modules**, **HVDC Equipment** in this ECC.6.3 should be read accordingly. For the avoidance of doubt, the requirements applicable to **Synchronous Power Generating Modules** also apply to **Synchronous Electricity Storage Modules** and the requirements applicable to **Power Park Modules** apply to **Non-Synchronous Electricity Storage Modules**. In addition, the requirements applicable to **Electricity Storage Modules** also apply irrespective of whether the **Electricity Storage Module** operates in such a mode as to import or export power from the **Total System**.

Plant Performance Requirements

ECC.6.3.2 REACTIVE CAPABILITY

ECC.6.3.2.1 Reactive Capability for Type B Synchronous Power Generating Modules

ECC.6.3.2.1.1 When operating at **Maximum Capacity**, all **Type B Synchronous Power Generating Modules** must be capable of continuous operation at any points between the limits of 0.95 **Power Factor** lagging and 0.95 **Power Factor** leading at the **Grid Entry Point** or **User System Entry Point** unless otherwise agreed with **The Company** or relevant **Network Operator**. At **Active Power** output levels other than **Maximum Capacity**, all **Generating Units** within a **Type B Synchronous Power Generating Module** must be capable of continuous operation at any point between the **Reactive Power** capability limits identified on the **HV Generator Performance Chart** unless otherwise agreed with **The Company** or relevant **Network Operator**.

ECC.6.3.2.2 Reactive Capability for Type B Power Park Modules

ECC.6.3.2.2.1 When operating at **Maximum Capacity** all **Type B Power Park Modules** must be capable of continuous operation at any points between the limits of 0.95 **Power Factor** lagging and 0.95 **Power Factor** leading at the **Grid Entry Point** or **User System Entry Point** unless otherwise agreed with **The Company** or relevant **Network Operator**. At **Active Power** output levels other than **Maximum Capacity**, each **Power Park Module** must be capable of continuous operation at any point between the **Reactive Power** capability limits identified on the **HV Generator Performance Chart** unless otherwise agreed with **The Company** or **Network Operator**.

ECC.6.3.2.3 Reactive Capability for Type C and D Synchronous Power Generating Modules

ECC.6.3.2.3.1 In addition to meeting the requirements of ECC.6.3.2.3.2 – ECC.6.3.2.3.5, **EU Generators** which connect a **Type C** or **Type D Synchronous Power Generating Module(s)** to a **Non Embedded Customers System** or private network, may be required to meet additional reactive compensation requirements at the point of connection between the **System** and the **Non Embedded Customer** or private network where this is required for **System** reasons.

ECC.6.3.2.3.2 All **Type C** and **Type D Synchronous Power Generating Modules** shall be capable of satisfying the **Reactive Power** capability requirements at the **Grid Entry Point** or **User System Entry Point** as defined in Figure ECC.6.3.2.3 when operating at **Maximum Capacity**.

ECC.6.3.2.3.3 At **Active Power** output levels other than **Maximum Capacity**, all **Generating Units** within a **Synchronous Power Generating Module** must be capable of continuous operation at any point between the **Reactive Power** capability limit identified on the **HV Generator Performance Chart** at least down to the **Minimum Stable Operating Level**. At reduced **Active Power** output, **Reactive Power** supplied at the **Grid Entry Point** (or **User System Entry Point** if **Embedded**) shall correspond to the **HV Generator Performance Chart** of the **Synchronous Power Generating Module**, taking the auxiliary supplies and the **Active Power** and **Reactive Power** losses of the **Generating Unit** transformer or **Station Transformer** into account.

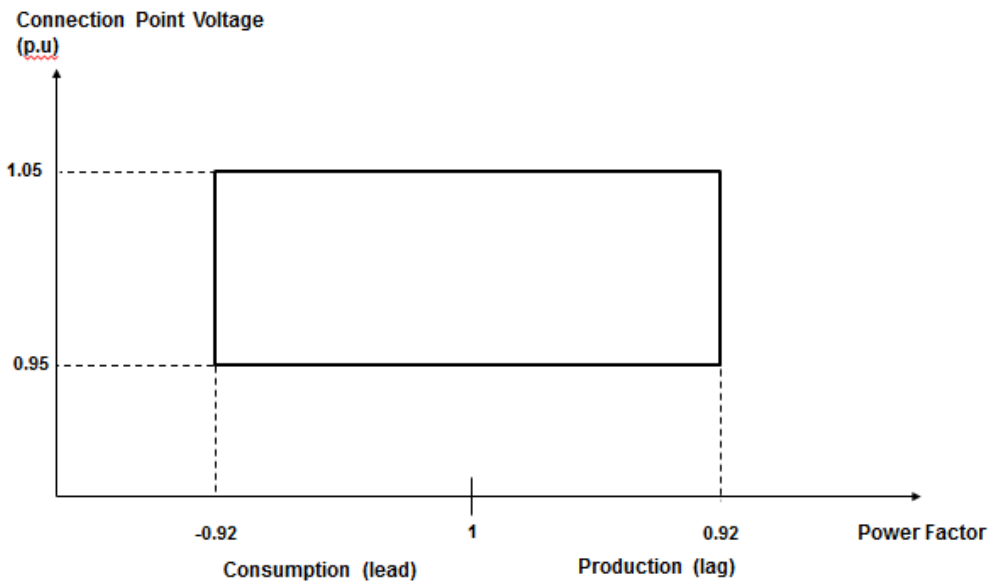

Figure ECC.6.3.2.3

ECC.6.3.2.3.4 In addition, to the requirements of ECC.6.3.2.3.1 – ECC.6.3.2.3.3 the short circuit ratio of all **Onshore Synchronous Generating Units** with an **Apparent Power** rating of less than 1600MVA shall not be less than 0.5. The short circuit ratio of **Onshore Synchronous Generating Units** with a rated **Apparent Power** of 1600MVA or above shall be not less than 0.4.

ECC.6.3.2.4 Reactive Capability for Type C and D Power Park Modules, HVDC Equipment and OTSDUW Plant and Apparatus at the Interface Point

ECC.6.3.2.4.1 **EU Generators** or **HVDC System Owners** which connect an **Onshore Type C** or **Onshore Type D Power Park Module** or **HVDC Equipment** to a **Non Embedded Customers System** or private network, may be required to meet additional reactive compensation requirements at the point of connection between the **System** and the **Non Embedded Customer** or private network where this is required for **System** reasons.

ECC.6.3.2.4.2

All **Onshore Type C Power Park Modules** and **Onshore Type D Power Park Modules** or **HVDC Converters** at an **HVDC Converter Station** with a **Grid Entry Point** or **User System Entry Point** voltage above 33kV, or **Remote End HVDC Converters** with an **HVDC Interface Point** voltage above 33kV, or **OTSDUW Plant and Apparatus** with an **Interface Point** voltage above 33kV shall be capable of satisfying the **Reactive Power** capability requirements at the **Grid Entry Point** or **User System Entry Point** (or **Interface Point** in the case of **OTSDUW Plant and Apparatus**, or **HVDC Interface Point** in the case of a **Remote End HVDC Converter Station**) as defined in Figure ECC.6.3.2.4(a) when operating at **Maximum Capacity** (or **Interface Point Capacity** in the case of **OTSUW Plant and Apparatus**). In the case of **Remote End HVDC Converters** and **DC Connected Power Park Modules**, **The Company** in co-ordination with the **Relevant Transmission Licensee** may agree to alternative reactive capability requirements to those specified in Figure ECC.6.3.2.4(a), where it is demonstrated that it is uneconomic and inefficient to do so, for example in the case of new technologies or advanced control strategies. For the avoidance of doubt, the requirements for **Offshore Power Park Modules** and **DC Connected Power Park Modules** are defined in ECC.6.3.2.5 and ECC.6.3.2.6.

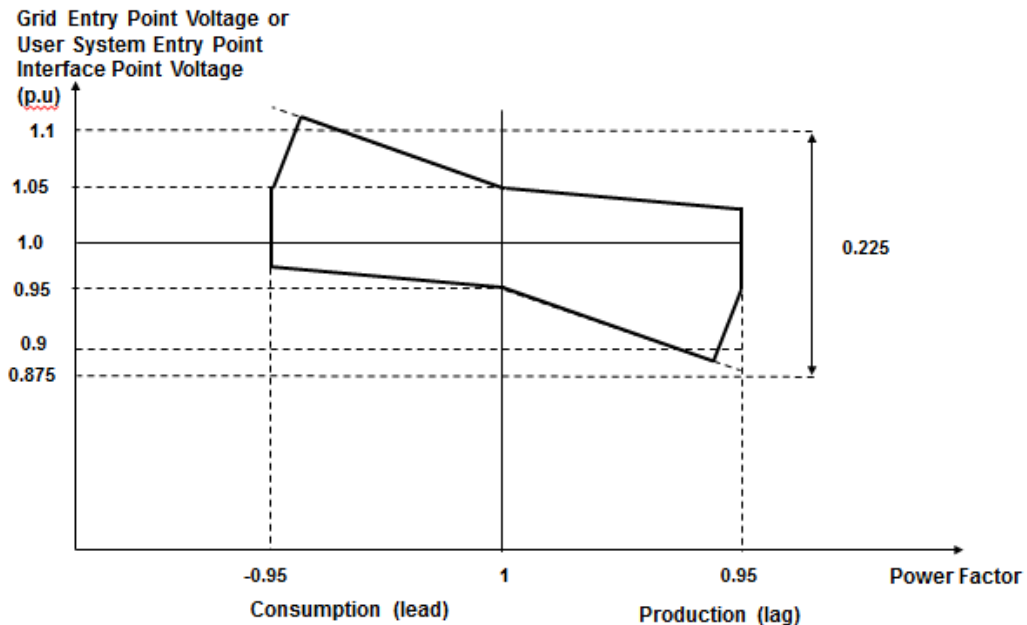

Figure ECC.6.3.2.4(a)

ECC.6.3.2.4.3

All **Onshore Type C** or **Type D Power Park Modules** or **HVDC Converters** at a **HVDC Converter Station** with a **Grid Entry Point** or **User System Entry Point** voltage at or below 33kV or **Remote End HVDC Converter Station** with an **HVDC Interface Point Voltage** at or below 33kV shall be capable of satisfying the **Reactive Power** capability requirements at the **Grid Entry Point** or **User System Entry Point** as defined in Figure ECC.6.3.2.4(b) when operating at **Maximum Capacity**. In the case of **Remote End HVDC Converters** **The Company** in co-ordination with the **Relevant Transmission Licensee** may agree to alternative reactive capability requirements to those specified in Figure ECC.6.3.2.4(b), where it is demonstrated that it is uneconomic and inefficient to do so, for example in the case of new technologies or advanced control strategies. For the avoidance of doubt, the requirements for **Offshore Power Park Modules** and **DC Connected Power Park Modules** are defined in ECC.6.3.2.5 and ECC.6.3.2.6.

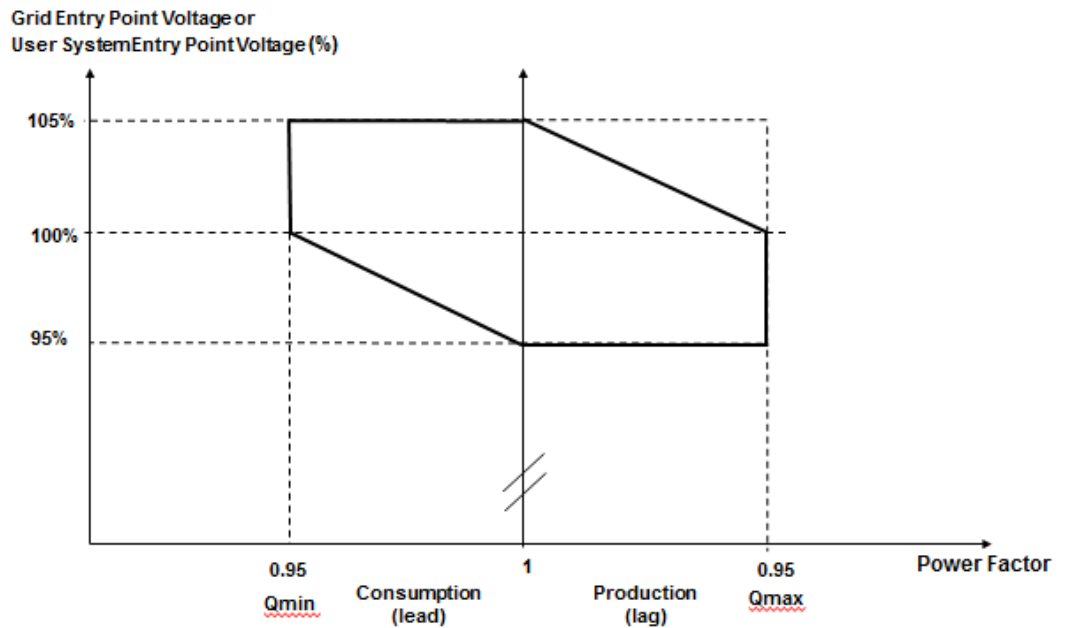

Figure ECC.6.3.2.4(b)

ECC.6.3.2.4.4 All **Type C** and **Type D Power Park Modules, HVDC Converters** at a **HVDC Converter Station** including **Remote End HVDC Converters** or **OTSDUW Plant and Apparatus**, shall be capable of satisfying the **Reactive Power** capability requirements at the **Grid Entry Point** or **User System Entry Point** (or **Interface Point Capacity** in the case of **OTSUW Plant and Apparatus** or **HVDC Interface Point** in the case of **Remote End HVDC Converter Stations**) as defined in Figure ECC.6.3.2.4(c) when operating below **Maximum Capacity**. With all **Plant** in service, the **Reactive Power** limits will reduce linearly below 50% **Active Power** output as shown in Figure ECC.6.3.2.4(c) unless the requirement to maintain the **Reactive Power** limits defined at **Maximum Capacity** (or **Interface Point Capacity** in the case of **OTSDUW Plant and Apparatus**) under absorbing **Reactive Power** conditions down to 20% **Active Power** output has been specified by **The Company**. These **Reactive Power** limits will be reduced pro rata to the amount of **Plant** in service. In the case of **Remote End HVDC Converters**, **The Company** in co-ordination with the **Relevant Transmission Licensee** may agree to alternative reactive capability requirements to those specified in Figure ECC.6.3.2.4(a), where it is demonstrated that it is uneconomic and inefficient to do so, for example in the case of new technologies or advanced control strategies. For the avoidance of doubt, the requirements for **Offshore Power Park Modules** and **DC Connected Power Park Modules** are defined in ECC.6.3.2.5 and ECC.6.3.2.6.

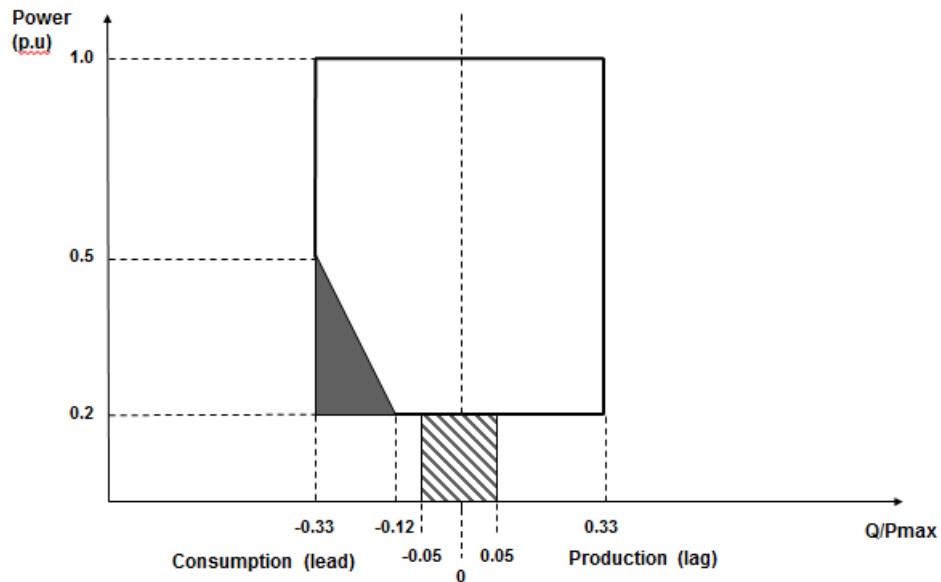

Figure ECC.6.3.2.4(c)

ECC.6.3.2.5 Reactive Capability for Offshore Synchronous Power Generating Modules, Configuration 1 AC connected Offshore Power Park Modules and Configuration 1 DC Connected Power Park Modules.

ECC.6.3.2.5.1 The short circuit ratio of any **Offshore Synchronous Generating Units** within a **Synchronous Power Generating Module** shall not be less than 0.5. Notwithstanding the requirements of ECC.6.3.2.5.2 and ECC.6.3.2.5.3, all **Offshore Synchronous Generating Units, Configuration 1 AC Connected Offshore Power Park Modules or Configuration 1 DC Connected Power Park Modules** must be capable of maintaining zero transfer of **Reactive Power** at the **Offshore Grid Entry Point**. The steady state tolerance on **Reactive Power** transfer to and from an **Offshore Transmission System** expressed in **MVAR** shall be no greater than 5% of the **Maximum Capacity**.

ECC.6.3.2.5.2 If an **EU Generator** (including those in respect of **DC Connected Power Park Modules** or those which are **Restoration Contractors**), wish to provide a **Reactive Power** capability in excess of the minimum requirements defined in ECC.6.3.2.5.1, then such capability (including steady state tolerance) shall be agreed between the **Generator, Offshore Transmission Licensee and The Company** and/or the relevant **Network Operator**.

ECC.6.3.2.5.3 In the case of **EU Code Users** and **Restoration Contractors** who own and operate **Anchor Plant** and/or **Top Up Restoration Plant** or **EU Code Users** who own and operate **Plant** and **Apparatus** which is operating with a **Grid Forming Capability** in service, the **Reactive Power** capability requirements (including steady state tolerance) at the **Offshore Grid Entry Point** shall be agreed between the **Restoration Contractor or EU Code User, the Offshore Transmission Licensee and The Company** in order to facilitate the operation of an **Offshore Local Joint Restoration Plan**.

ECC.6.3.2.6 Reactive Capability for Configuration 2 AC Connected Offshore Power Park Modules and Configuration 2 DC Connected Power Park Modules.

ECC.6.3.2.6.1 All **Configuration 2 AC connected Offshore Power Park Modules** and **Configuration 2 DC Connected Power Park Modules** shall be capable of satisfying the minimum **Reactive Power** capability requirements at the **Offshore Grid Entry Point** as defined in Figure ECC.6.3.2.6(a) when operating at **Maximum Capacity**. **The Company** in co-ordination with the **Relevant Transmission Licensee** may agree to alternative reactive capability requirements to those specified in Figure ECC.6.3.2.6(a), where it is demonstrated that it is uneconomic and inefficient to do so, for example in the case of new technologies or advanced control strategies.

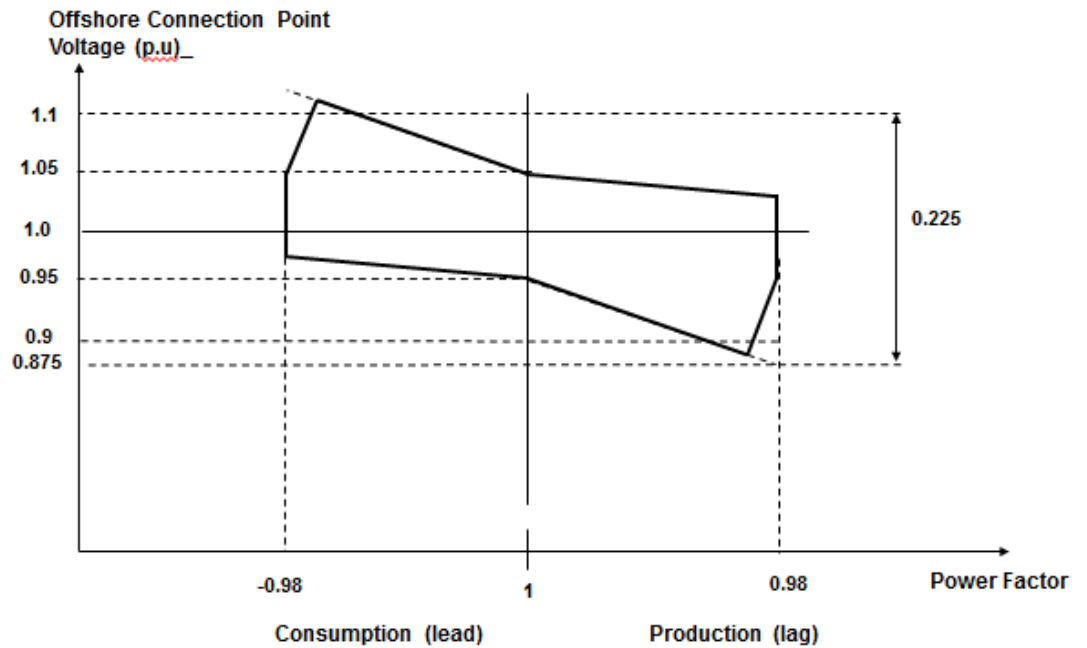

Figure ECC.6.3.2.6(a)

ECC.6.3.2.6.2

All **AC Connected Configuration 2 Offshore Power Park Modules** and **Configuration 2 DC Connected Power Park Modules** shall be capable of satisfying the **Reactive Power** capability requirements at the **Offshore Grid Entry Point** as defined in Figure ECC.6.3.2.6(b) when operating below **Maximum Capacity**. With all **Plant** in service, the **Reactive Power** limits will reduce linearly below 50% **Active Power** output as shown in Figure ECC.6.3.2.6(b) unless the requirement to maintain the **Reactive Power** limits defined at **Maximum Capacity** (or **Interface Point Capacity** in the case of **OTSDUW Plant and Apparatus**) under absorbing **Reactive Power** conditions down to 20% **Active Power** output has been specified with **The Company**. These **Reactive Power** limits will be reduced pro rata to the amount of **Plant** in service. **The Company** in co-ordination with the **Relevant Transmission Licensee** may agree to alternative reactive capability requirements to those specified in Figure ECC.6.3.2.6(b), where it is demonstrated that it is uneconomic and inefficient to do so, for example in the case of new technologies or advanced control strategies.

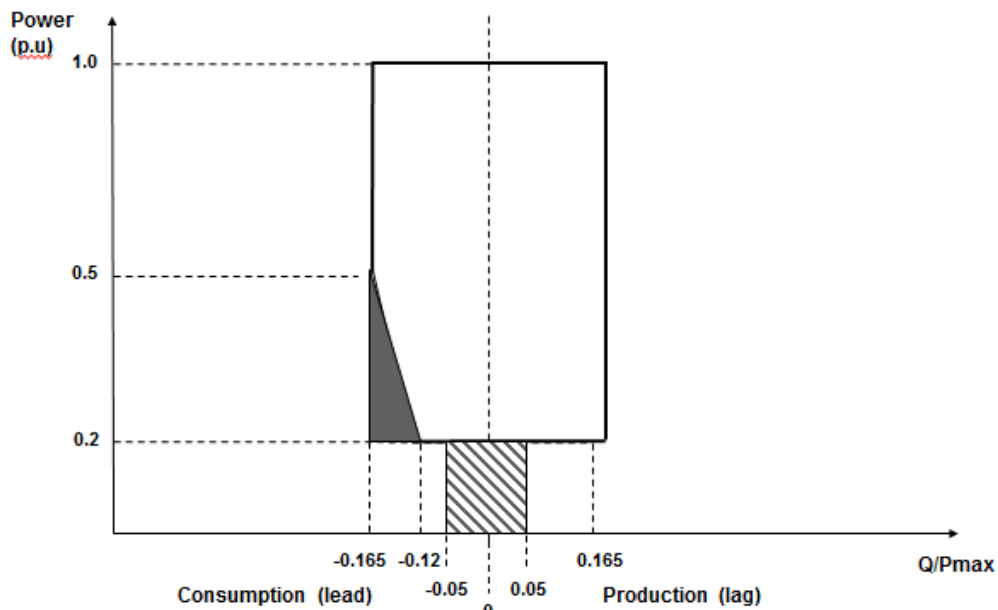

Figure ECC.6.3.2.6(b)

ECC.6.3.2.6.3 For the avoidance of doubt, if an **EU Generator** (including **Generators** in respect of **DC Connected Power Park Modules** or those which are **Restoration Contractors** referred to in ECC.6.3.2.6.2) wishes to provide a **Reactive Power** capability in excess of the minimum requirements defined in ECC.6.3.2.6.1, then such capability (including any steady state tolerance) shall be agreed between the **EU Generator, Offshore Transmission Licensee** and **The Company** and/or the relevant **Network Operator**.

ECC.6.3.2.6.4 In addition to the requirements of ECC.6.3.2.6.2, **EU Generators** and **HVDC System Owners** and **Restoration Contractors** who own and operate **Anchor Plant** and/or **Top Up Restoration Plant**, then the **Reactive Power** capability requirements (including steady state tolerance) at the **Offshore Grid Entry Point** shall be agreed between the **Generator, Offshore Transmission Licensee** and **The Company** in order to facilitate the operation of an **Offshore Local Joint Restoration Plan**.

ECC.6.3.3 OUTPUT POWER WITH FALLING FREQUENCY

ECC.6.3.3.1 Output power with falling frequency for **Power Generating Modules** and **HVDC Equipment**

ECC.6.3.3.1.1 Each **Power Generating Module** and **HVDC Equipment** must be capable of:

- (a) continuously maintaining constant **Active Power** output for **System Frequency** changes within the range 50.5 to 49.5 Hz; and

- (b) (subject to the provisions of ECC.6.1.2) maintaining its **Active Power** output at a level not lower than the figure determined by the linear relationship shown in Figure ECC.6.3.3(a) for **System Frequency** changes within the range 49.5 to 47 Hz for all ambient temperatures up to and including 25⁰C, such that if the **System Frequency** drops to 47 Hz the **Active Power** output does not decrease by more than 5%. In the case of a **CCGT Module**, the above requirement shall be retained down to the **Low Frequency Relay** trip setting of 48.8 Hz, which reflects the first stage of the Automatic Low **Frequency Demand Disconnection** scheme notified to **Network Operators** under OC6.6.2. For **System Frequency** below that setting, the existing requirement shall be retained for a minimum period of 5 minutes while **System Frequency** remains below that setting, and special measure(s) that may be required to meet this requirement shall be kept in service during this period. After that 5 minutes period, if **System Frequency** remains below that setting, the special measure(s) must be discontinued if there is a materially increased risk of the **Gas Turbine** tripping. The need for special measure(s) is linked to the inherent **Gas Turbine Active Power** output reduction caused by reduced shaft speed due to falling **System Frequency**. Where the need for special measures is identified in order to maintain output in line with the level identified in Figure ECC.6.3.3(a) these measures should be still continued at ambient temperatures above 25⁰C maintaining as much of the **Active Power** achievable within the capability of the plant. For the avoidance of doubt, **Generators** in respect of **Pumped Storage** shall also be required to satisfy the requirements of OC6.6.6.

Figure ECC.6.3.3(a) **Active Power** Output with falling frequency for **Power Generating Modules and HVDC Systems and Electricity Storage Modules** when operating in an exporting mode of operation

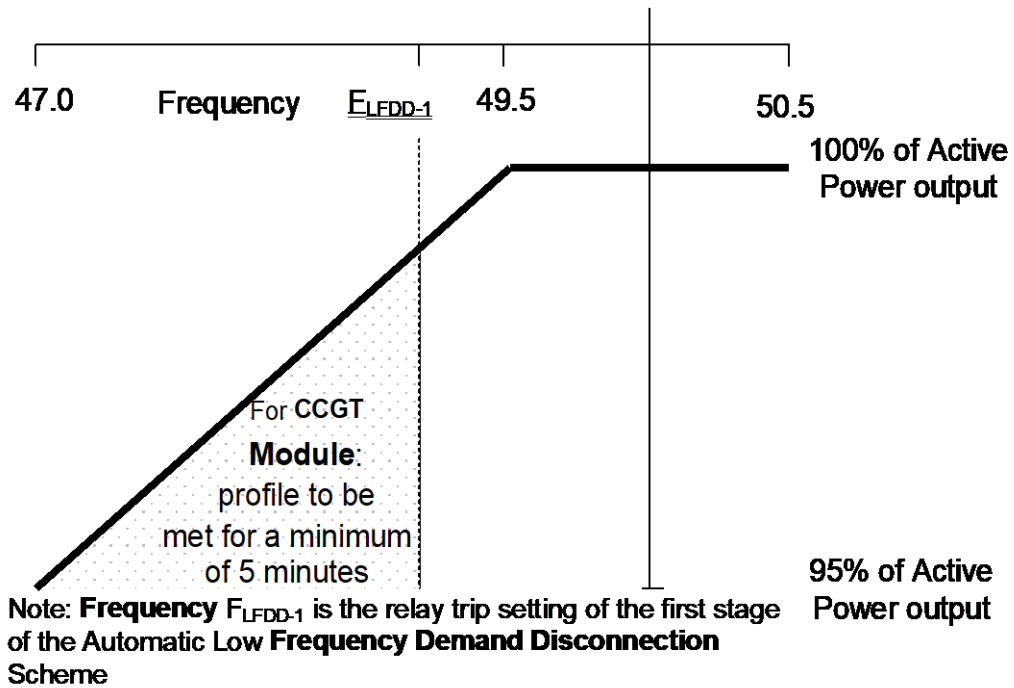

- (c) For the avoidance of doubt, in the case of a **Power Generating Module** including a **DC Connected Power Park Module** using an **Intermittent Power Source** where the mechanical power input will not be constant over time, the requirement is that the **Active Power** output shall be independent of **System Frequency** under (a) above and should not drop with **System Frequency** by greater than the amount specified in (b) above.
- (d) An **HVDC System** must be capable of maintaining its **Active Power** input (i.e. when operating in a mode analogous to **Demand**) from the **National Electricity Transmission System** (or **User System** in the case of an **Embedded HVDC System**) at a level not greater than the figure determined by the linear relationship shown in Figure ECC.6.3.3(b) for **System Frequency** changes within the range 49.5 to 47 Hz, such that if the **System Frequency** drops to 47.8 Hz the **Active Power** input decreases by more than 60%.

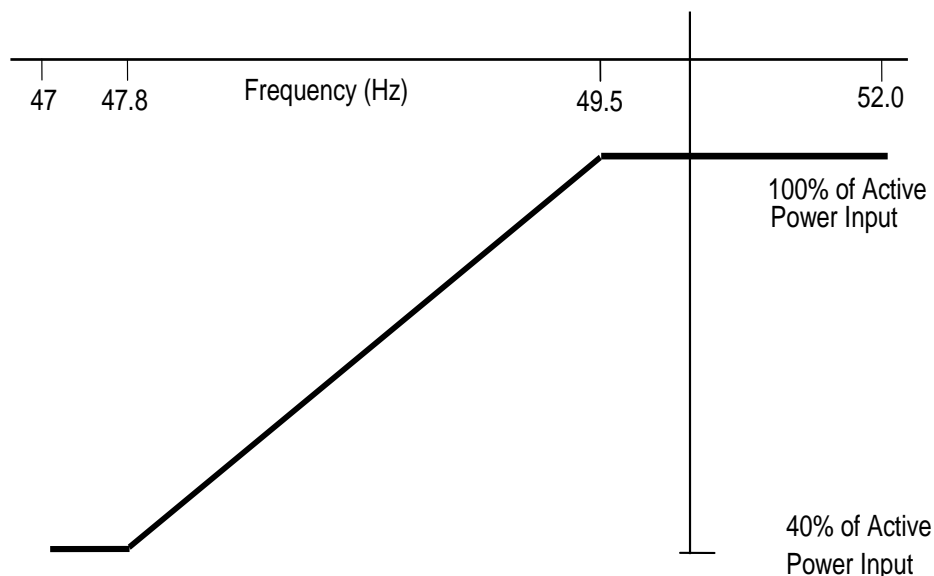

Figure ECC.6.3.3(b) **Active Power** input with falling frequency for **HVDC Systems**

- (e) In the case of an **Offshore Generating Unit** or **Offshore Power Park Module** or **DC Connected Power Park Module** or **Remote End HVDC Converter** or **Transmission DC Converter**, the **EU Generator** shall comply with the requirements of ECC.6.3.3. **EU Generators** should be aware that Section K of the **STC** places requirements on **Offshore Transmission Licensees** which utilise a **Transmission DC Converter** as part of their **Offshore Transmission System** to make appropriate provisions to enable **EU Generators** to fulfil their obligations.
- (f) **Transmission DC Converters** and **Remote End HVDC Converters** shall provide a continuous signal indicating the real time frequency measured at the **Interface Point** to the **Offshore Grid Entry Point** or **HVDC Interface Point** for the purpose of **Offshore Generators** or **DC Connected Power Park Modules** to respond to changes in **System Frequency** on the Main Interconnected **Transmission System**. A **DC Connected Power Park Module** or **Offshore Power Generating Module** shall be capable of receiving and processing this signal within 100ms.
- (g) For **HVDC Systems** with a **Completion Date** on or after 31 December 2026, **HVDC System Owners** shall ensure that each **HVDC System** has the capability to provide a continuous signal indicating the real time frequency measured at the **Grid Entry Point** and **HVDC Interface Point** and other signals as agreed with **The Company** for the purpose of participating in a **Local Joint Restoration Plan** or wider **System Restoration** event. The frequency signal at the **Interface Point** shall be capable of being received and processed within 100ms.
- (h) For **Transmission DC Converters** with a **Completion Date** on or after 31 December 2026, **Offshore Transmission Licensees** shall ensure that each **Transmission DC Converter** has the capability to provide a continuous signal indicating the real time frequency measured at the **Offshore Grid Entry Point** and **HVDC Interface Point** to the **Interface Point** for the purpose of participating in an **Offshore Local Joint Restoration Plan** or wider **System Restoration** event. The frequency signal at the **Interface Point** shall be capable of being received and processed within 100ms. This requirement shall be necessary where one or more **Offshore Generators** are part of an **Offshore Local Joint Restoration Zone Plan**.

ECC.6.3.4 ACTIVE POWER OUTPUT UNDER SYSTEM VOLTAGE VARIATIONS

ECC.6.3.4.1 At the **Grid Entry Point** or **User System Entry Point**, the **Active Power** output under steady state conditions of any **Power Generating Module** or **HVDC Equipment** directly connected to the **National Electricity Transmission System** or in the case of **OTSDUW**, the **Active Power** transfer at the **Interface Point**, under steady state conditions of any **OTSDUW Plant and Apparatus** should not be affected by voltage changes in the normal operating range specified in paragraph ECC.6.1.4 by more than the change in **Active Power** losses at reduced or increased voltage.

ECC.6.3.5 SYSTEM RESTORATION

ECC.6.3.5.1 It is not a mandatory requirement for **Generators**, or **HVDC System Owners** to provide an **Anchor Plant Capability** or **Top Up Restoration Capability**, however **EU Code Users** may wish to notify **The Company** of their ability to provide such a facility and the cost of the service. **The Company** will then consider whether it wishes to contract with the **EU Code User** for the provision of such a service which would be specified via an **Anchor Restoration Contract** or **Top Up Restoration Contract**. Where an **EU Code User** does not offer to provide a cost for the provision of an **Anchor Plant Capability**, **The Company** may make such a request if it considers **System** security to be at risk due to a lack of **Anchor Plant** capability.

- ECC.6.3.5.2 It is an essential requirement that **The Company** has a means of implementing **System Restoration** in accordance with the requirements of the **Electricity System Restoration Standard**. This is facilitated by agreeing contracts with **Restoration Contractors** who have **Plant** at a number of strategically located sites. In the case of **Restoration Contractors** who are party to a **Distribution Restoration Zone Plan**, **The Company** shall agree the requirements with the relevant **Network Operator** and **Restoration Contractors**.
- ECC.6.3.5.3 The following requirements shall apply in respect of each **Type C Power Generating Module**, **Type D Power Generating Module** and **DC Connected Power Park Module** which have an **Anchor Restoration Contract**.
- (i) The **Power-Generating Module** or **DC Connected Power Park Module** shall be capable of starting from a **Total Shutdown** or **Partial Shutdown** without any external electrical energy supply within either 2 hours of receiving an instruction from **The Company** in the case of **Local Joint Restoration Plan** or alternatively 8 hours of receiving an instruction from a **Network Operator** in the case of a **Distribution Restoration Zone Plan**;
 - (ii) Each **Power Generating Module** or **DC Connected Power Park Module** shall be able to synchronise within the frequency limits defined in ECC.6.1.2 and, where applicable, voltage limits specified in ECC.6.1.4;
 - (iii) The **Power Generating Module** or **DC Connected Power Park Module** shall be capable of energising an unenergised part of the **System**;
 - (iv) The **Power-Generating Module** or **DC Connected Power Park Module** shall be capable of automatically regulating dips in voltage caused by connection of demand;
 - (v) The **Power Generating Module** or **DC Connected Power Park Module** shall;
 - be capable of a **Block Load Capability**,
 - be capable of operating in **LFSM-O** and **LFSM-U**, as specified in ECC.6.3.7.1 and ECC.6.3.7.2,
 - control **Frequency** in case of overfrequency and underfrequency within the whole **Active Power** output range between the **Minimum Regulating Level** and **Maximum Capacity** as well as at **Houseload Operation** levels, and
 - be capable of parallel operation together with other **Power Generating Modules** including **DC Connected Power Park Modules** within an isolated part of the **Total System** that is still supplying **Customers**, and controlling voltage automatically during the system restoration phase;
 - (vi) **Power Park Modules** (including **DC Connected Power Park Modules**) and **HVDC Equipment** which provide an **Anchor Plant Capability**, shall also be capable of satisfying the relevant **Grid Forming Capability** requirements defined in ECC.6.3.19 as agreed with **The Company**.
- ECC.6.3.5.4 Each **HVDC System** or **Remote End HVDC Converter Station** which has **Anchor Plant Capability** and an **Anchor Restoration Contract** shall be capable of energising the busbar of an AC substation to which another **HVDC Converter Station** is connected. The timeframe after shutdown of the **HVDC System** prior to energisation of the AC substation shall be pursuant to the terms of the **Anchor Restoration Contract**. The **HVDC System** shall be able to synchronise within the **Frequency** limits defined in ECC.6.1.2.1.2 and voltage limits defined in ECC.6.1.4.1 unless otherwise specified in the **Anchor Restoration Contract**. Wider **Frequency** and voltage ranges can be specified in the **Anchor Restoration Contract** in order to restore **System** security.
- ECC.6.3.5.5 With regard to the capability to take part in operation of an isolated part of the **Total System** that is still supplying **Customers**:
- i **Power Generating Modules** including **DC Connected Power Park Modules** shall be capable of taking part in island operation if specified in the **Anchor Restoration Contract** or **Top Up Restoration Contract** and:

- ii the **Frequency** limits for island operation shall be those specified in ECC.6.1.2;
- iii the voltage limits for island operation shall be those defined in ECC.6.1.4;
- iv **Power Generating Modules** including **DC Connected Power Park Modules** shall be able to operate in **Frequency Sensitive Mode** during island operation, as specified in ECC.6.3.7.3. In the event of a power surplus, **Power Generating Modules** including **DC Connected Power Park Modules** shall be capable of reducing the **Active Power** output from a previous operating point to any new operating point within the **Power Generating Module Performance Chart**. **Power Generating Modules** including **DC Connected Power Park Modules** shall be capable of reducing **Active Power** output as much as inherently technically feasible, but to at least 55 % of **Maximum Capacity**;
- v The method for detecting a change from interconnected system operation to island operation shall be agreed between the **EU Generator**, **The Company** and the **Relevant Transmission Licensee**. The agreed method of detection must not rely solely on **The Company**, **Relevant Transmission Licensee's** or **Network Operators** switchgear position signals;
- vi **Power Generating Modules** including **DC Connected Power Park Modules** shall be able to operate in **LFSM-O** and **LFSM-U** during island operation, as specified in ECC.6.3.7.1 and ECC.6.3.7.2;

ECC.6.3.5.6 With regard to quick re-synchronisation capability:

- (i) In case of disconnection of the **Power Generating Module** including **DC Connected Power Park Modules** from the **System**, the **Power Generating Module** shall be capable of quick re-synchronisation in line with the **Protection** strategy agreed between **The Company** and/or **Network Operator** in co-ordination with the **Relevant Transmission Licensee** and the **Generator**;
- (ii) A **Power Generating Module** including a **DC Connected Power Park Module** with a minimum re-synchronisation time greater than 15 minutes after its disconnection from any external power supply must be capable of **Houseload Operation** from any operating point on its **Power Generating Module Performance Chart**. In this case, the identification of **Houseload Operation** must not be based solely on the **Total System's**-switchgear position signals;
- (iii) **Power Generating Modules** including **DC Connected Power Park Modules** shall be capable of **Houseload Operation**, irrespective of any auxiliary connection to the **Total System**. The minimum operation time shall be specified by **The Company**, taking into consideration the specific characteristics of prime mover technology.

ECC.6.3.5.7 **Restoration Contractors** who are **Offshore Generators** and **Transmission DC Converter** owners who are part of an **Offshore Local Joint Restoration Plan** shall ensure their **Plant** and **Apparatus** is designed to satisfy the requirements of ECC.7.10 and ECC.7.11.

ECC.6.3.6 CONTROL ARRANGEMENTS

ECC.6.3.6.1 ACTIVE POWER CONTROL

ECC.6.3.6.1.1 Active Power control in respect of Power Generating Modules including DC Connected Power Park Modules

ECC.6.3.6.1.1.1 **Type A Power Generating Modules** shall be equipped with a logic interface (input port) in order to cease **Active Power** output within five seconds following receipt of a signal from **The Company**. **The Company** shall specify the requirements for such facilities, including the need for remote operation, in the **Bilateral Agreement** where they are necessary for **System** reasons .

ECC.6.3.6.1.1.2 **Type B Power Generating Modules** shall be equipped with an interface (input port) in order to be able to reduce **Active Power** output following receipt of a signal from **The Company**. **The Company** shall specify the requirements for such facilities, including the need for remote operation, in the **Bilateral Agreement** where they are necessary for **System** reasons.

ECC.6.3.6.1.1.3 **Type C and Type D Power Generating Modules and DC Connected Power Park Modules** shall be capable of adjusting the **Active Power** setpoint in accordance with instructions issued by **The Company**.

ECC.6.3.6.1.2 **Active Power control in respect of HVDC Systems and Remote End HVDC Converter Stations**

ECC.6.3.6.1.2.1 **HVDC Systems** shall be capable of adjusting the transmitted **Active Power** upon receipt of an instruction from **The Company** which shall be in accordance with the requirements of BC2.6.1.

ECC.6.3.6.1.2.2 The requirements for fast **Active Power** reversal (if required) shall be specified by **The Company**. Where **Active Power** reversal is specified in the **Bilateral Agreement**, each **HVDC System** and **Remote End HVDC Converter Station** shall be capable of operating from maximum import to maximum export in a time which is as fast as technically feasible or in a time that is no greater than 2 seconds except where a **HVDC Converter Station Owner** has justified to **The Company** that a longer reversal time is required.

ECC.6.3.6.1.2.3 Where an **HVDC System** connects various **Control Areas** or **Synchronous Areas**, each **HVDC System** or **Remote End HVDC Converter Station** shall be capable of responding to instructions issued by **The Company** under the **Balancing Code** to modify the transmitted **Active Power** for the purposes of cross-border balancing.

ECC.6.3.6.1.2.4 An **HVDC System** shall be capable of adjusting the ramping rate of **Active Power** variations within its technical capabilities in accordance with instructions issued by **The Company**. In case of modification of **Active Power** according to ECC.6.3.15 and ECC.6.3.6.1.2.2, there shall be no adjustment of ramping rate.

ECC.6.3.6.1.2.5 If specified by **The Company**, in coordination with the **Relevant Transmission Licensees**, the control functions of an **HVDC System** shall be capable of taking automatic remedial actions including, but not limited to, stopping the ramping and blocking FSM, LFSM-O, LFSM-U and **Frequency** control. The triggering and blocking criteria shall be specified by **The Company**.

ECC.6.3.6.2 **MODULATION OF ACTIVE POWER**

ECC.6.3.6.2.1 Each **Power Generating Module** (including **DC Connected Power Park Modules**) and **Onshore HVDC Converters** at an **Onshore HVDC Converter Station** must be capable of contributing to **Frequency** control by continuous modulation of **Active Power** supplied to the **National Electricity Transmission System**. For the avoidance of doubt each **Onshore HVDC Converter** at an **Onshore HVDC Converter Station** and/or **OTSDUW DC Converter** shall provide each **EU Code User** in respect of its **Offshore Power Stations** connected to and/or using an **Offshore Transmission System** a continuous signal indicating the real time **Frequency** measured at the **Transmission Interface Point**. A **DC Connected Power Park Module** or **Offshore Power Generating Module** shall be capable of receiving and processing this signal within 100ms.

ECC.6.3.6.3 **MODULATION OF REACTIVE POWER**

ECC.6.3.6.3.1 Notwithstanding the requirements of ECC.6.3.2, each **Power Generating Module** or **HVDC Equipment** (and **OTSDUW Plant and Apparatus** at a **Transmission Interface Point** and **Remote End HVDC Converter** at an **HVDC Interface Point**) (as applicable) must be capable of contributing to voltage control by continuous changes to the **Reactive Power** supplied to the **National Electricity Transmission System** or the **User System** in which it is **Embedded**.

ECC.6.3.7 **FREQUENCY RESPONSE**

ECC.6.3.7.1 Limited Frequency Sensitive Mode – Overfrequency (LFSM-O)

- ECC.6.3.7.1.1 Each **Power Generating Module** (including **DC Connected Power Park Modules**) and **HVDC Systems** shall be capable of reducing **Active Power** output in response to **Frequency** on the **Total System** when this rises above 50.4Hz. For the avoidance of doubt, the provision of this reduction in **Active Power** output is not an **Ancillary Service**. Such provision is known as **Limited High Frequency Response**. The **Power Generating Module** (including **DC Connected Power Park Modules**) or **HVDC Systems** shall be capable of operating stably during **LFSM-O** operation. However for a **Power Generating Module** (including **DC Connected Power Park Modules**) or **HVDC Systems** operating in **Frequency Sensitive Mode** the requirements of **LFSM-O** shall apply when the frequency exceeds 50.5Hz.
- ECC.6.3.7.1.2 (i) The rate of change of **Active Power** output must be at a minimum a rate of 2 percent of output per 0.1 Hz deviation of **System Frequency** above 50.4Hz (ie a **Droop** of 10%) as shown in Figure ECC.6.3.7.1 below. This would not preclude a **EU Generator** or **HVDC System Owner** from designing their **Power Generating Module** with a **Droop** of less than 10% but in all cases the **Droop** should be 2% or greater.
- (ii) The reduction in **Active Power** output must be continuously and linearly proportional, as far as is practicable, to the excess of **Frequency** above 50.4 Hz and must be provided increasingly with time over the period specified in (iii) below.
- (iii) As much as possible of the proportional reduction in **Active Power** output must result from the frequency control device (or speed governor) action and must be achieved within 10 seconds of the time of the **Frequency** increase above 50.4 Hz. The **Power Generating Module** (including **DC Connected Power Park Modules**) or **HVDC Systems** shall be capable of initiating a power **Frequency** response with an initial delay that is as short as possible. If the delay exceeds 2 seconds the **EU Generator** or **HVDC System Owner** shall justify the variation, providing technical evidence to **The Company**.
- (iv) The residue of the proportional reduction in **Active Power** output which results from automatic action of the **Power Generating Module** (including **DC Connected Power Park Modules**) or **HVDC System** output control devices other than the frequency control devices (or speed governors) must be achieved within 3 minutes for the time of the **Frequency** increase above 50.4Hz.
- (v) For the avoidance of doubt, the **LFSM-O** response must be reduced when the **Frequency** falls again and, when to a value less than 50.4Hz, as much as possible of the increase in **Active Power** must be achieved within 10 seconds.
- (vi) For **Type A** and **Type B Power Generating Modules** which are not required to have **Frequency Sensitive Mode (FSM)** as described in ECC.6.3.7.3 for deviations in **Frequency** up to 50.9Hz at least half of the proportional reduction in **Active Power** output must be achieved in 10 seconds of the time of the **Frequency** increase above 50.4Hz. For deviations in **Frequency** beyond 50.9Hz the measured rate of change of **Active Power** reduction must exceed 0.5%/sec of the initial output. The **LFSM-O** response must be reduced when the **Frequency** subsequently falls again and when to a value less than 50.4Hz, at least half the increase in **Active Power** must be achieved in 10 seconds. For a **Frequency** excursion returning from beyond 50.9Hz the measured rate of change of **Active Power** increase must exceed 0.5%/second.

Active Power Frequency response capability of when operating in LFSM-O

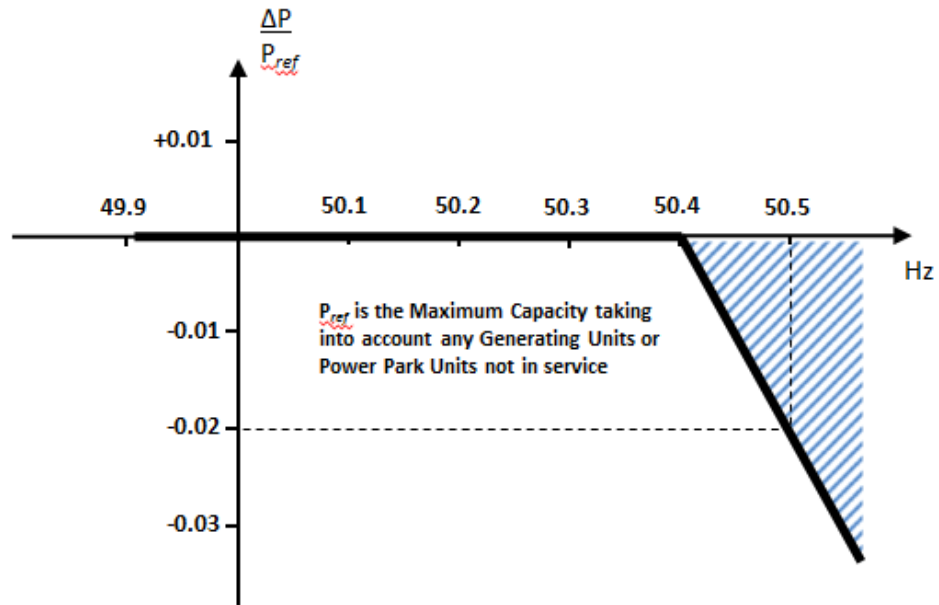

Figure ECC.6.3.7.1 – P_{ref} is the reference **Active Power** to which ΔP is related and ΔP is the change in **Active Power** output from the **Power Generating Module** (including **DC Connected Power Park Modules**) or **HVDC System**. The **Power Generating Module** (including **DC Connected Power Park Modules** or **HVDC Systems**) has to provide a negative **Active Power** output change with a droop of 10% or less based on P_{ref} .

ECC.6.3.7.1.3 Each **Power Generating Module** (including **DC Connected Power Park Modules**) or **HVDC Systems** which is providing **Limited High Frequency Response (LFSM-O)** must continue to provide it until the **Frequency** has returned to or below 50.4Hz or until otherwise instructed by **The Company**. **EU Generators** in respect of **Gensets** and **HVDC Converter Station Owners** in respect of an **HVDC System** should also be aware of the requirements in BC.3.7.2.2.

ECC.6.3.7.1.4 Steady state operation below the **Minimum Stable Operating Level** in the case of **Power Generating Modules** including **DC Connected Power Park Modules** or **Minimum Active Power Transmission Capacity** in the case of **HVDC Systems** is not expected but if **System** operating conditions cause operation below the **Minimum Stable Operating Level** or **Minimum Active Power Transmission Capacity** which could give rise to operational difficulties for the **Power Generating Module** including a **DC Connected Power Park Module** or **HVDC Systems** then the **EU Generator** or **HVDC System Owner** shall be able to return the output of the **Power Generating Module** including a **DC Connected Power Park Module** to an output of not less than the **Minimum Stable Operating Level** or **HVDC System** to an output of not less than the **Minimum Active Power Transmission Capacity**.

ECC.6.3.7.1.5 All reasonable efforts should in the event be made by the **EU Generator** or **HVDC System Owner** to avoid such tripping provided that the **System Frequency** is below 52Hz in accordance with the requirements of ECC.6.1.2. If the **System Frequency** is at or above 52Hz, the requirement to make all reasonable efforts to avoid tripping does not apply and the **EU Generator** or **HVDC System Owner** is required to take action to protect its **Power Generating Modules** including **DC Connected Power Park Modules** or **HVDC Converter Stations**.

ECC.6.3.7.2 Limited Frequency Sensitive Mode – Underfrequency (LFSM-U)

ECC.6.3.7.2.1 Each **Type C Power Generating Module** and **Type D Power Generating Module** (including **DC Connected Power Park Modules**) or **HVDC Systems** operating in **Limited Frequency Sensitive Mode** shall be capable of increasing **Active Power** output in response to **System Frequency** when this falls below 49.5Hz. For the avoidance of doubt, the provision of this increase in **Active Power** output is not a mandatory **Ancillary Service** and it is not anticipated **Power Generating Modules** (including **DC Connected Power Park Modules**) or **HVDC Systems** are operated in an inefficient mode to facilitate delivery of **LFSM-U** response, but any inherent capability (where available) should be made without undue delay. The **Power Generating Module** (including **DC Connected Power Park Modules**) or **HVDC Systems** shall be capable of stable operation during **LFSM-U Mode**. For example, an **EU Generator** which is operating with no headroom (eg it is operating at maximum output or is de-loading as part of a run down sequence and has no headroom) would not be required to provide **LFSM-U**.

ECC.6.3.7.2.2 (i) The rate of change of **Active Power** output must be at a minimum a rate of 2 percent of output per 0.1 Hz deviation of **System Frequency** below 49.5Hz (ie a **Droop** of 10%) as shown in Figure ECC.6.3.7.2.2 below. This requirement only applies if the **Power Generating Module** has headroom and the ability to increase **Active Power** output. In the case of a **Power Park Module** or **DC Connected Power Park Module** the requirements of Figure ECC.6.3.7.2.2 shall be reduced pro-rata to the amount of **Power Park Units** in service and available to generate. For the avoidance of doubt, this would not preclude an **EU Generator** or **HVDC System Owner** from designing their **Power Generating Module** with a lower **Droop** setting, for example between 3 – 5%.

(ii) As much as possible of the proportional increase in **Active Power** output must result from the **Frequency** control device (or speed governor) action and must be achieved for **Frequencies** below 49.5 Hz. The **Power Generating Module** (including **DC Connected Power Park Modules**) or **HVDC Systems** shall be capable of initiating a power **Frequency** response with minimal delay. If the delay exceeds 2 seconds the **EU Generator** or **HVDC System Owner** shall justify the delay, providing technical evidence to **The Company**).

(iii) The actual delivery of **Active Power Frequency Response** in **LFSM-U** mode shall take into account

The ambient conditions when the response is to be triggered

The operating conditions of the **Power Generating Module** (including **DC Connected Power Park Modules**) or **HVDC Systems** in particular limitations on operation near **Maximum Capacity** or **Maximum HVDC Active Power Transmission Capacity** at low frequencies and the respective impact of ambient conditions as detailed in ECC.6.3.3.

The availability of primary energy sources.

(iv) In **LFSM_U Mode**, the **Power Generating Module** (including **DC Connected Power Park Modules**) and **HVDC Systems**, shall be capable of providing a power increase up to its **Maximum Capacity** or **Maximum HVDC Active Power Transmission Capacity** (as applicable).

Active Power Frequency response capability of when operating in LFSM-U

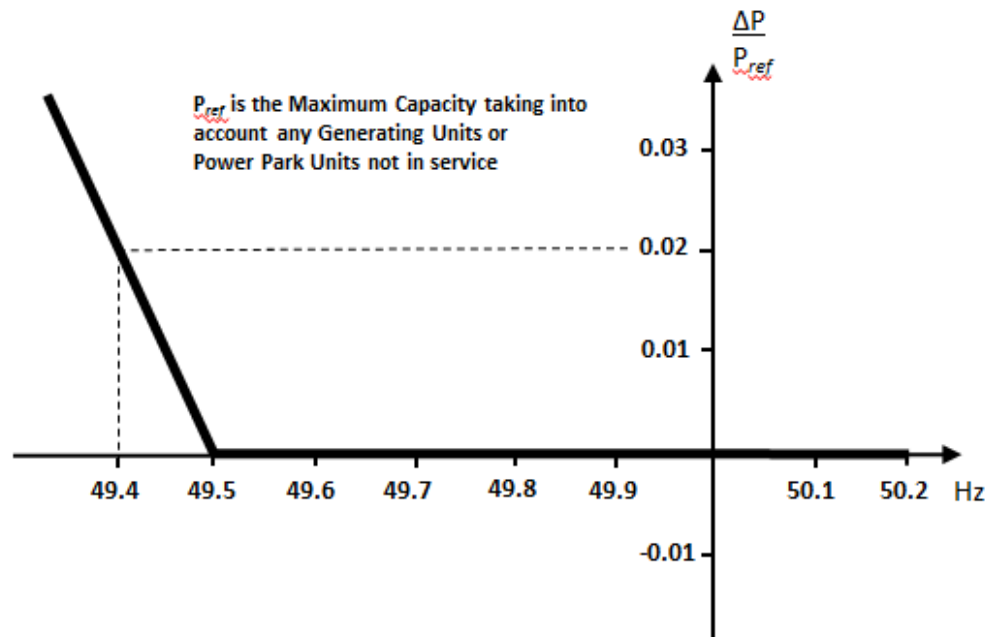

Figure ECC.6.3.7.2.2 – P_{ref} is the reference **Active Power** to which ΔP is related and ΔP is the change in **Active Power** output from the **Power Generating Module** (including **DC Connected Power Park Modules**) or **HVDC System**. The **Power Generating Module** (including **DC Connected Power Park Modules** or **HVDC Systems**) has to provide a positive **Active Power** output change with a droop of 10% or less based on P_{ref} .

ECC.6.3.7.2.3 Limited Frequency Sensitive Mode Electricity Storage Modules when operating in an importing mode of operation

ECC.6.3.7.2.3.1 Each **Generator** or **Defence Service Provider** or **Restoration Contractor** or **Non-Embedded Customer** in respect of an **Electricity Storage Module** is required to meet the requirements of ECC.6.3.7.2.3.1 (a) – (f) except where it has been agreed with **The Company** that such an **Electricity Storage Module** is unable to meet these requirements in which case the requirements of OC6.6.6 shall apply:-

- (a) Be capable of automatically maintaining its **Active Power** output within the shaded operating region shown in Figure ECC.6.3.7.2.3(a) until the stored energy has been depleted, except in the case of a **Restoration Contractor** which shall not deplete its stored energy below the level required to meet its contractual obligations. The **Electricity Storage Module** could initially be operating at any level of import between zero **Active Power** and the **Maximum Import Power** within a **System Frequency** range of 50Hz and 49.5Hz as shown in Figure ECC.6.3.7.2.3(a). For the avoidance of doubt, the **Electricity Storage Module** would only be required to reach its **Maximum Capacity** if the **Electricity Storage Module** has headroom and the ability to increase **Active Power** output. A typical value of the **Droop** would be 0.6% where this does not result in control system instability or plant difficulties. In all cases the **Droop** shall be between 0.6% and 1.2% and shall be agreed with **The Company**.
- (b) Automatically respond in accordance with the characteristic of Figure ECC.6.3.7.2.3(a) when the **System Frequency** falls to 49.5Hz and below.
- (c) The reduction in **Active Power** import (during an import mode of operation), and the transition to the final value of **Active Power** output shall be continuously and linearly proportional, as far as is practicable, to the reduction in **Frequency** below 49.5 Hz. **Active Power** output must be provided increasingly with time as required by ECC.6.3.7.2.3.1 (d) below.

- (d) As much as possible of the proportional reduction in **Active Power** import (when the **Electricity Storage Module** is in a mode analogous to **Demand**) must result from the **Frequency** control device (or speed governor) action and must be achieved within 10 seconds of the time of the **Frequency** decreases below 49.5 Hz. The **Electricity Storage Module** shall be capable of initiating a power **Frequency** response with an initial delay that is as short as possible. Delays that exceed 2 seconds shall be justified by the **Generator** or **Defence Service Provider** or **Restoration Contractor** or **Non-Embedded Customer** providing technical evidence to **The Company** and in any event as much as possible of the proportional reduction in **Active Power** import shall be achieved within 10 seconds. This performance requirement is to be maintained when the **Electricity Storage Module** makes the transition to an **Active Power** export mode of operation unless the energy store is depleted, in which case it shall be required to operate at zero **Active Power** output.
- (e) Where the **Electricity Storage Module** is not capable of making a transition from import operation to export operation within 20 seconds of the **System Frequency** falling to 49.2Hz, then it shall then immediately reduce its **Active Power** import to zero.
- (f) If the **Electricity Storage Module** has not achieved at least a zero **Active Power** import when the **System Frequency** has reached 48.9Hz, it shall be instantaneously tripped. Where a **Electricity Storage Module** trips, it shall not be permitted to reconnect to the **System** until instructed by **The Company** in accordance with BC2.5.2 and as provided for in ECC.6.2.2.11.

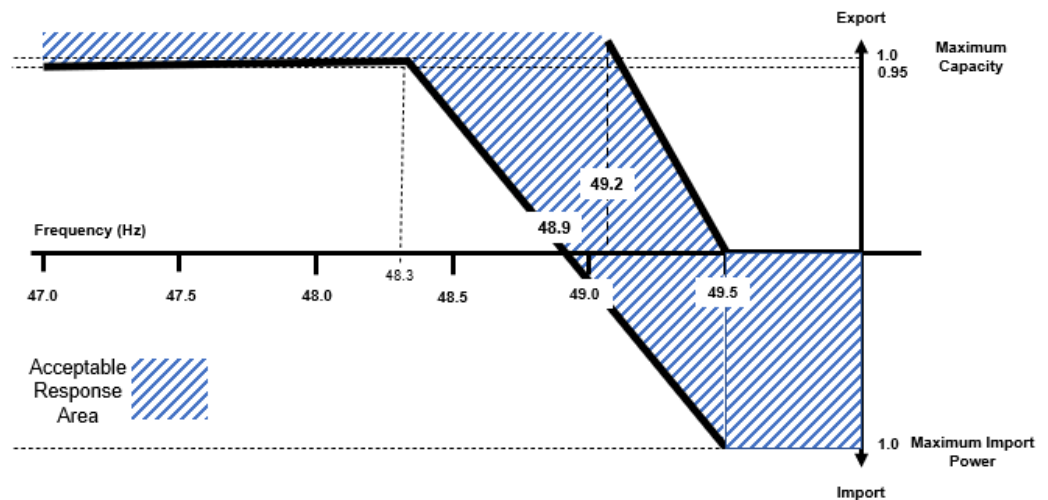

Figure ECC.6.3.7.2.3(a) **Active Power** performance with falling frequency

ECC.6.3.7.2.3.2 Where an **Electricity Storage Module** has been importing and has responded in accordance with the requirements of ECC.6.3.7.2.3.1, its performance, once the **System Frequency** starts to rise above the minimum reached, shall be in accordance with Figure ECC.6.3.7.2.3(b) in respect of the **Active Power** output and **Active Power** import. For example, Figure ECC.6.3.7.2.3(b), illustrates the four operating points W, X, Y and Z. If points W, X, Y and Z denotes the minimum frequency that the **Total System** reached during a particular low **System Frequency** event, as the **System Frequency** starts to rise, the **Active Power** output of the **Electricity Storage Module** should remain at a constant level (where the energy source has not been depleted) until 49.5Hz is reached as denoted by the dashed black lines. Once the **System Frequency** has risen above 49.5Hz the **Electricity Storage Module** is permitted to reduce **Active Power** output so long as it is operates within the shaded area above 49.5Hz shown in Figure ECC.6.3.7.2.3(b), unless the **Electricity Storage Module** has insufficient capability in which case it shall operate at zero **Active Power**.

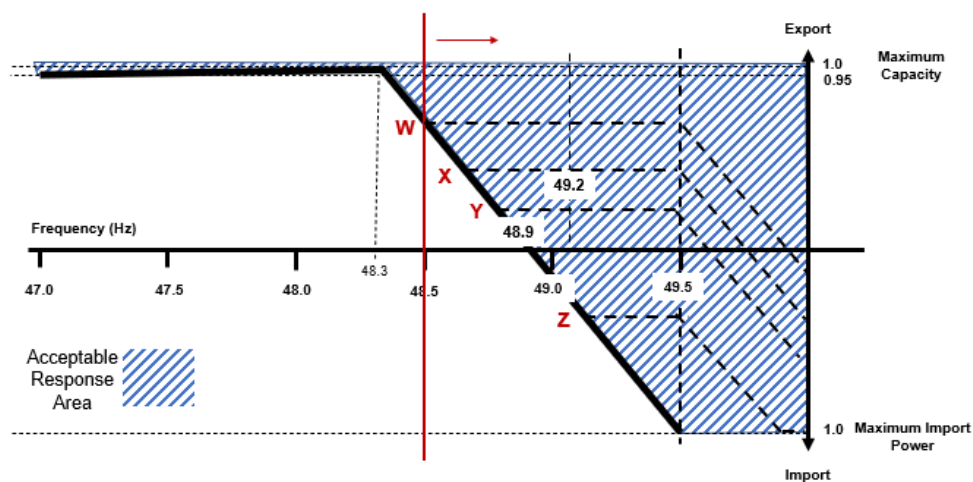

Figure ECC.6.3.7.2.3(b) **Active Power** performance with increasing frequency

ECC.6.3.7.2.3.3 Where an **Electricity Storage Module** is exporting **Active Power** to the **Total System** (including zero) and the **System Frequency** falls below 49.5Hz the requirements of ECC.6.3.7.2.1 and ECC.6.3.7.2.2 shall apply.

ECC.6.3.7.3 Frequency Sensitive Mode – (FSM)

ECC.6.3.7.3.1 In addition to the requirements of ECC.6.3.7.1 and ECC.6.3.7.2 each **Type C Power Generating Module** and **Type D Power Generating Module** (including **DC Connected Power Park Modules**) or **HVDC Systems** must be fitted with a fast acting proportional **Frequency** control device (or turbine speed governor) and unit load controller or equivalent control device to provide **Frequency** response under normal operational conditions in accordance with **Balancing Code 3 (BC3)**. In the case of a **Power Park Module** including a **DC Connected Power Park Module**, the **Frequency** or speed control device(s) may be on the **Power Park Module** (including a **DC Connected Power Park Module**) or on each individual **Power Park Unit** (including a **Power Park Unit** within a **DC Connected Power Park Module**) or be a combination of both. The **Frequency** control device(s) (or speed governor(s)) must be designed and operated to the appropriate:

- (i) **European Specification:** or
- (ii) in the absence of a relevant **European Specification**, such other standard which is in common use within the European Community (which may include a manufacturer specification);

as at the time when the installation of which it forms part was designed or (in the case of modification or alteration to the **Frequency** control device (or turbine speed governor)) when the modification or alteration was designed.

The **European Specification** or other standard utilised in accordance with sub paragraph ECC.6.3.7.3.1 (a) (ii) will be notified to **The Company** by the **EU Generator** or **HVDC System Owner**:

- (i) as part of the application for a **Bilateral Agreement**; or
- (ii) as part of the application for a varied **Bilateral Agreement**; or
- (iii) in the case of an Embedded Development, within 28 days of entry into the Embedded Development Agreement (or such later time as agreed with **The Company**) or
- (iv) as soon as possible prior to any modification or alteration to the **Frequency** control device (or governor); and

ECC.6.3.7.3.2 The **Frequency** control device (or speed governor) in co-ordination with other control devices must control each **Type C Power Generating Module** and **Type D Power Generating Module** (including **DC Connected Power Park Modules**) or **HVDC Systems Active Power Output** or **Active Power** transfer capability with stability over the entire operating range of the **Power Generating Module** (including **DC Connected Power Park Modules**) or **HVDC Systems** ; and

ECC.6.3.7.3.3 **Type C** and **Type D Power Generating Modules** and **DC Connected Power Park Modules** shall also meet the following minimum requirements:

- (i) capable of providing **Active Power Frequency** response in accordance with the performance characteristic shown in Figure 6.3.7.3.3(a) and parameters in Table 6.3.7.3.3(a)

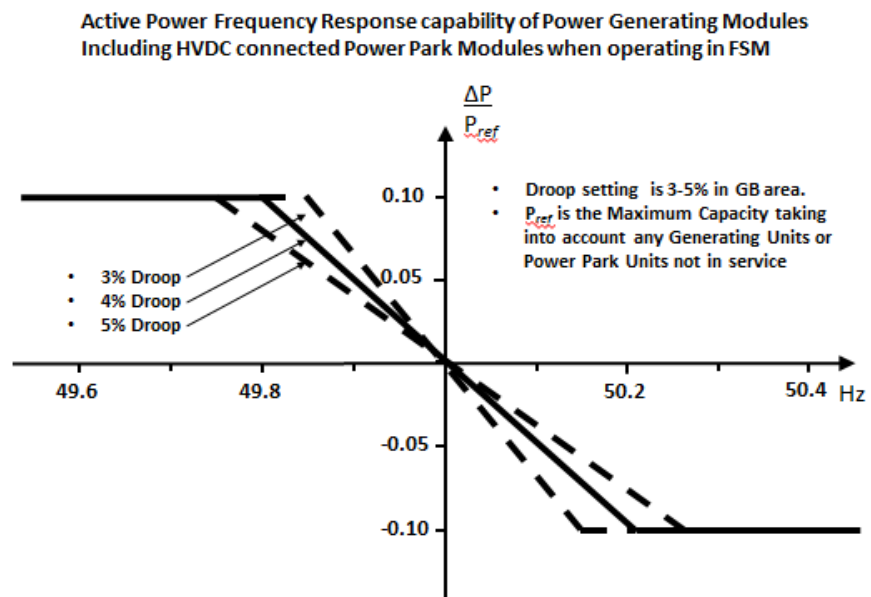

Figure 6.3.7.3.3(a) – **Frequency Sensitive Mode** capability of **Power Generating Modules** and **DC Connected Power Park Modules**

Parameter	Setting
Nominal System Frequency	50Hz
Active Power as a percentage of Maximum Capacity ($\frac{ \Delta P_1 }{P_{max}}$)	10%

Frequency Response Insensitivity in mHz ($ \Delta f_i $)	± 15 mHz
Frequency Response Insensitivity as a percentage of nominal frequency ($\frac{ \Delta f_i }{f_n}$)	$\pm 0.03\%$
Frequency Response Deadband in mHz	0 (mHz)
Droop (%)	3 – 5%

Table 6.3.7.3.3(a) – Parameters for **Active Power Frequency** response in **Frequency Sensitive Mode** including the mathematical expressions in Figure 6.3.7.3.3(a).

- (ii) In satisfying the performance requirements specified in ECC.6.3.7.3(i) **EU Generators** in respect of each **Type C** and **Type D Power Generating Modules and DC Connected Power Park Module** should be aware:-

in the case of overfrequency, the **Active Power Frequency** response is limited by the **Minimum Regulating Level**,

in the case of underfrequency, the **Active Power Frequency** response is limited by the **Maximum Capacity**,

the actual delivery of **Active Power** frequency response depends on the operating and ambient conditions of the **Power Generating Module** (including **DC Connected Power Park Modules**) when this response is triggered, in particular limitations on operation near **Maximum Capacity** at low **Frequencies** as specified in ECC.6.3.3 and available primary energy sources.

The frequency control device (or speed governor) must also be capable of being set so that it operates with an overall speed **Droop** of between 3 – 5%. The **Frequency Response Deadband** and **Droop** must be able to be reselected repeatedly. For the avoidance of doubt, in the case of a **Power Park Module** (including **DC Connected Power Park Modules**) the speed **Droop** should be equivalent of a fixed setting between 3% and 5% applied to each **Power Park Unit** in service.

- (iii) In the event of a **Frequency** step change, each **Type C** and **Type D Power Generating Module** and **DC Connected Power Park Module** shall be capable of activating full and stable **Active Power Frequency** response (without undue power oscillations), in accordance with the performance characteristic shown in Figure 6.3.7.3.3(b) and parameters in Table 6.3.7.3.3(b).

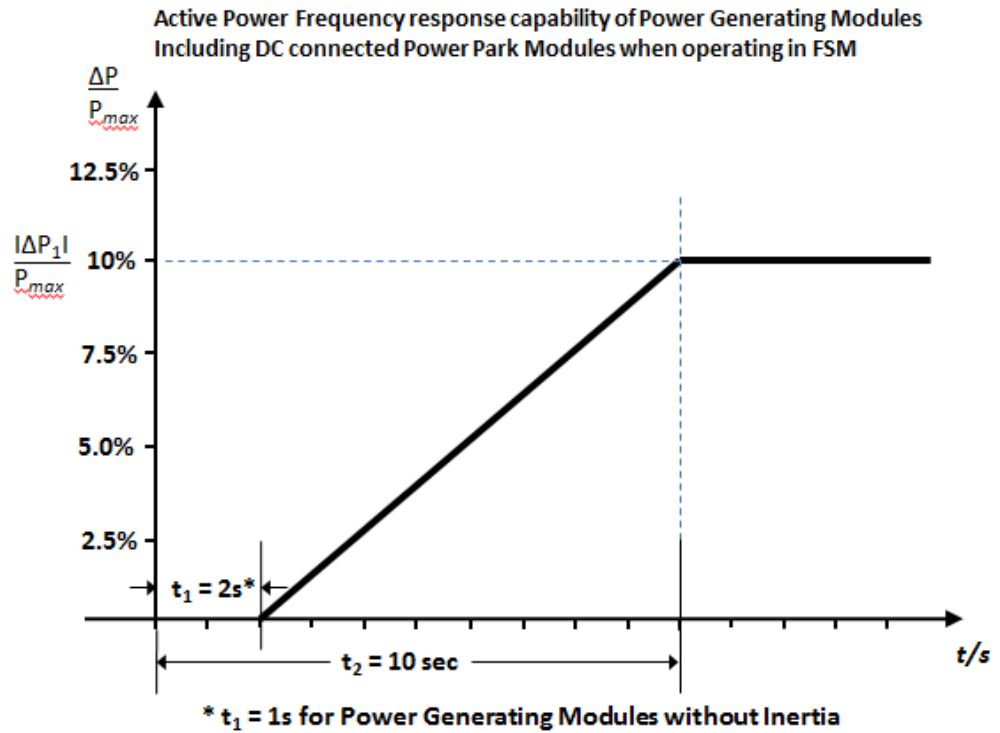

Figure 6.3.7.3.3(b) Active Power Frequency Response capability.

Parameter	Setting
Active Power as a percentage of Maximum Capacity (frequency response range) $(\frac{ \Delta P_1 }{P_{max}})$	10%
Maximum admissible initial delay t_1 for Power Generating Modules (including DC Connected Power Park Modules) with inertia unless justified as specified in ECC.6.3.7.3.3 (iv)	2 seconds
Maximum admissible initial delay t_1 for Power Generating Modules (including DC Connected Power Park Modules) which do not contribute to System inertia unless justified as specified in ECC.6.3.7.3.3 (iv)	1 second
Activation time t_2	10 seconds

Table 6.3.7.3.3(b) – Parameters for full activation of **Active Power Frequency** response resulting from a **Frequency** step change. Table 6.3.7.3.3(b) also includes the mathematical expressions used in Figure 6.3.7.3.3(b).

- (iv) The initial activation of **Active Power Primary Frequency** response shall not be unduly delayed. For **Type C** and **Type D Power Generating Modules** (including **DC Connected Power Park Modules**) with inertia the delay in initial **Active Power Frequency** response shall not be greater than 2 seconds. For **Type C** and **Type D Power Generating Modules** (including **DC Connected Power Park Modules**) without inertia, the delay in initial **Active Power Frequency** response shall not be greater than 1 second. If the **Generator** cannot meet this requirement they shall provide technical evidence to **The Company** demonstrating why a longer time is needed for the initial activation of **Active Power Frequency** response.
- (v) in the case of **Type C** and **Type D Power Generating Modules** (including **DC Connected Power Park Modules**) other than the **Steam Unit** within a **CCGT Module** the combined effect of the **Frequency Response Insensitivity** and **Frequency Response Deadband** of the **Frequency** control device (or speed governor) should be no greater than 0.03Hz (for the avoidance of doubt, $\pm 0.015\text{Hz}$). In the case of the **Steam Unit** within a **CCGT Module**, the **Frequency Response Deadband** should be set to an appropriate value consistent with the requirements of ECC.6.3.7.3.5(ii) and the requirements of BC3.7.2.2 for the provision of **LFSM-O** taking account of any **Frequency Response Insensitivity** of the **Frequency** control device (or speed governor);

ECC.6.3.7.3.4 **HVDC Systems** shall also meet the following minimum requirements:

- (i) **HVDC Systems** shall be capable of responding to **Frequency** deviations in each connected **AC System** by adjusting their **Active Power** import or export as shown in Figure 6.3.7.3.4(a) with the corresponding parameters in Table 6.3.7.3.4(a).

Active Power Frequency response capability of HVDC systems when operating in FSI

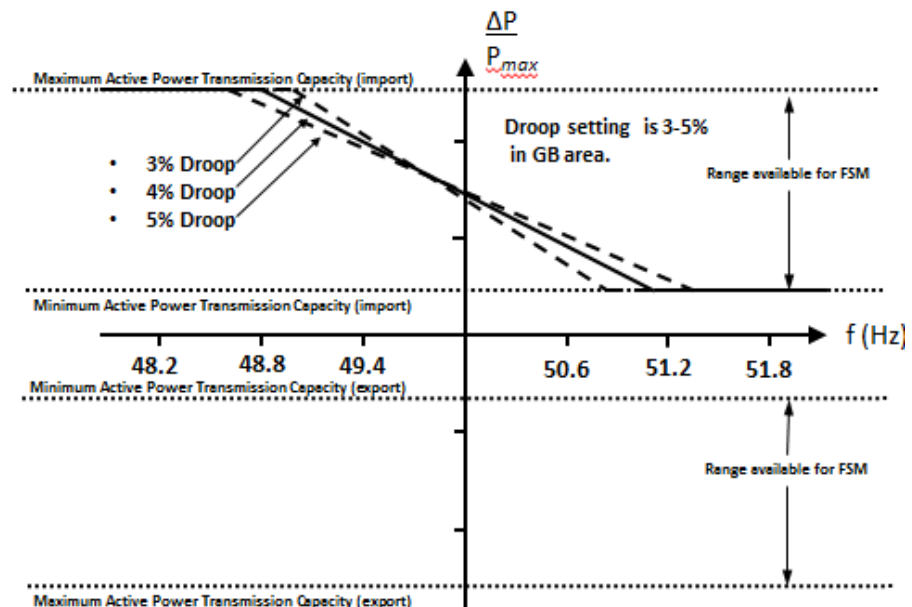

Figure 6.3.7.3.4(a) – **Active Power** frequency response capability of a **HVDC System** operating in **Frequency Sensitive Mode** (FSM). ΔP is the change in active power output from the **HVDC System**.

Parameter	Setting
Frequency Response Deadband	0

Droop S1 and S2 (upward and downward regulation) where S1=S2.	3 – 5%
Frequency Response Insensitivity	±15mHz

Table 6.3.7.3.4(a) – Parameters for **Active Power Frequency** response in **FSM** including the mathematical expressions in Figure 6.3.7.3.4.

- (ii) Each **HVDC System** shall be capable of adjusting the **Droop** for both upward and downward regulation and the **Active Power** range over which **Frequency Sensitive Mode** of operation is available as defined in ECC.6.3.7.3.4.
- (iii) In addition to the requirements in ECC.6.3.7.4(i) and ECC.6.3.7.4(ii) each **HVDC System** shall be capable of:-

delivering the response as soon as technically feasible

delivering the response on or above the solid line in Figure 6.3.7.3.4(b) in accordance with the parameters shown in Table 6.3.7.3.4(b)

initiating the delivery of **Primary Response** in no less than 0.5 seconds unless otherwise agreed with **The Company**. Where the initial delay time (t_1 – as shown in Figure 6.3.7.3.4(b)) is longer than 0.5 seconds the **HVDC Converter Station Owner** shall reasonably justify it to **The Company**.

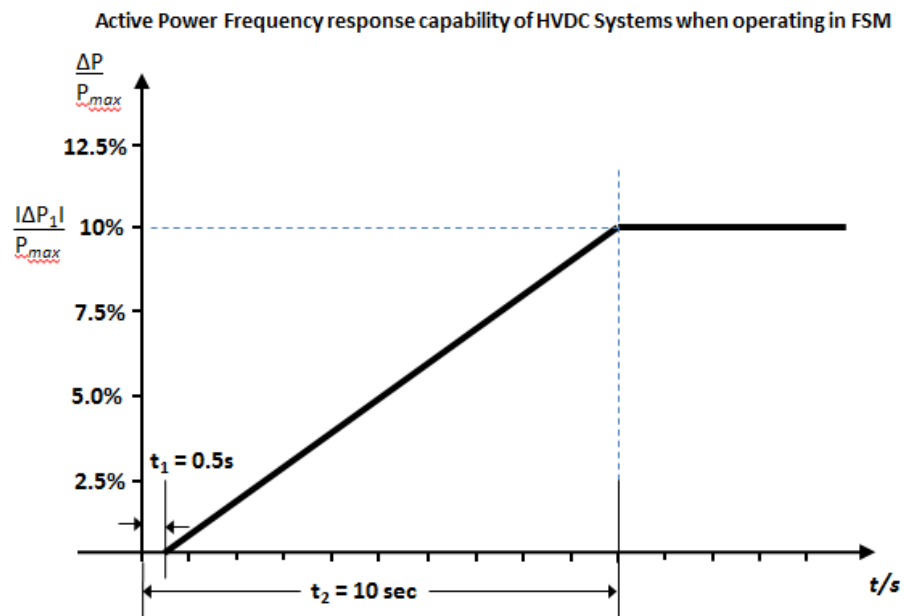

Figure 6.3.7.3.4(b) **Active Power Frequency Response** capability of a **HVDC System**. ΔP is the change in **Active Power** triggered by the step change in frequency

Parameter	Setting
Active Power as a percentage of Maximum Capacity (frequency response range) ($\frac{ \Delta P_1 }{P_{max}}$)	10%
Maximum admissible delay t_1	0.5 seconds

Maximum admissible time for full activation t_2 , unless longer activation times are agreed with The Company	10 seconds
---	------------

Table 6.3.7.3.4(b) – Parameters for full activation of **Active Power Frequency** response resulting from a **Frequency** step change.

- (iv) For **HVDC Systems** connecting various **Synchronous Areas**, each **HVDC System** shall be capable of adjusting the full **Active Power Frequency Response** when operating in **Frequency Sensitive Mode** at any time and for a continuous time period. In addition, the **Active Power** controller of each **HVDC System** shall not have any adverse impact on the delivery of frequency response.

ECC.6.3.7.3.5 For **HVDC Systems** and **Type C** and **Type D Power Generating Modules** (including **DC Connected Power Park Modules**), other than the **Steam Unit** within a **CCGT Module** the combined effect of the **Frequency Response Insensitivity** and **Frequency Response Deadband** of the **Frequency** control device (or speed governor) should be no greater than 0.03Hz (for the avoidance of doubt, $\pm 0.015\text{Hz}$). In the case of the **Steam Unit** within a **CCGT Module**, the **Frequency Response Deadband** should be set to an appropriate value consistent with the requirements of ECC.6.3.7.3.5(ii) and the requirements of BC3.7.2.2 for the provision of **LFSM-O** taking account of any **Frequency Response Insensitivity** of the **Frequency** control device (or speed governor);

- (i) With regard to disconnection due to underfrequency, **EU Generators** responsible for **Type C** and **Type D Power Generating Modules** (including **DC Connected Power Park Modules**) capable of acting as a load, including but not limited to **Pumped Storage** and tidal **Power Generating Modules**, **HVDC Systems** and **Remote End HVDC Converter Stations**, shall be capable of disconnecting their load in case of underfrequency which will be agreed with **The Company**. For the avoidance of doubt this requirement does not apply to station auxiliary supplies; **EU Generators** in respect of **Type C** and **Type D Pumped Storage Power Generating Modules** should also be aware of the requirements in OC.6.6.6.

- (ii) Where a **Type C** or **Type D Power Generating Module**, **DC Connected Power Park Module** or **HVDC System** becomes isolated from the rest of the **Total System** but is still supplying **Customers**, the **Frequency** control device (or speed governor) must also be able to control **System Frequency** below 52Hz unless this causes the **Type C** or **Type D Power Generating Module** or **DC Connected Power Park Module** to operate below its **Minimum Regulating Level** or **Minimum Active Power Transmission Capacity** when it is possible that it may, as detailed in BC 3.7.3, trip after a time. For the avoidance of doubt **Power Generating Modules** (including **DC Connected Power Park Modules**) and **HVDC Systems** are only required to operate within the **System Frequency** range 47 - 52 Hz as defined in ECC.6.1.2 and for converter based technologies, the remaining island contains sufficient fault level for effective commutation;

- (iii) Each **Type C** and **Type D Power Generating Module** and **HVDC Systems** shall have the facility to modify the **Target Frequency** setting either continuously or in a maximum of 0.05Hz steps over at least the range $50 \pm 0.1\text{Hz}$ should be provided in the unit load controller or equivalent device.

ECC.6.3.7.3.6 In addition to the requirements of ECC.6.3.7.3 each **Type C** and **Type D Power Generating Module** and **HVDC System** shall be capable of meeting the minimum **Frequency** response requirement profile subject to and in accordance with the provisions of Appendix A3.

ECC.6.3.7.3.7 For the avoidance of doubt, the requirements of Appendix A3 do not apply to **Type A** and **Type B Power Generating Modules**.

ECC.6.3.7.3.8 Frequency control device (or speed governor) requirements during System Restoration

- ECC.6.3.7.3.8.1 **Restoration Contractors** shall be capable of operating their **Generating Units** or **Power Generating Modules** or **HVDC Systems** such that the **Frequency** control device (or turbine speed governor) and unit load controller or equivalent control device can be switched to **Frequency** control only with no load influence, during the early stages of a **System Restoration** whilst in island operation.
- ECC.6.3.7.8.3.2 **Generators** and **HVDC System Owners** shall advise **The Company** of the capability of operating their **Generating Units** or **Power Generating Modules** or **HVDC Systems** such that the **Frequency** control device (or turbine speed governor) and unit load controller or equivalent control device can be switched to **Frequency** control only with no load influence during the early stages of **System Restoration** whilst in island operation. If there is a suitable capability, **The Company** and the **User** shall agree on how it shall be used and kept available.
- ECC.6.3.7.8.3.3 In addition to the requirements of ECC.6.3.7.8.3.1 and ECC.6.3.7.8.3.2 the following shall apply:-
- (i) Changes to any control schemes and settings identified from ECC.6.3.7.8.3.1, and ECC.6.3.7.8.3.2 shall be agreed between **The Company** and/or **Relevant Transmission Licensee** and/or **Network Operator** as recorded in the **Restoration Plan**.
 - (ii) During **System Restoration**, any changes to the schemes and settings defined in ECC.6.3.7.8.3.1 and ECC.6.3.7.8.3.2, of the different control devices of the **Generating Unit** or **Power Generating Module** or **Restoration Contractor's Plant** or **HVDC System** shall be coordinated and agreed between the **Relevant Transmission Licensee**, the **EU Generator**, **Restoration Contractor** and **HVDC System Owner** as part of a **Restoration Plan**.

ECC.6.3.8 EXCITATION AND VOLTAGE CONTROL PERFORMANCE REQUIREMENTS

ECC.6.3.8.1 Excitation Performance Requirements for Type B Synchronous Power Generating Modules

ECC.6.3.8.1.1 Each **Synchronous Generating Unit** within a **Type B Synchronous Power Generating Module** shall be equipped with a permanent automatic excitation control system that shall have the capability to provide constant terminal voltage control at a selectable setpoint without instability over the entire operating range of the **Type B Synchronous Power Generating Module**.

ECC.6.3.8.1.2 In addition to the requirements of ECC.6.3.8.1.1, **The Company** or the relevant **Network Operator** will specify if the control system of the **Type B Synchronous Power Generating Module** shall contribute to voltage control or **Reactive Power** control or **Power Factor** control at the **Grid Entry Point** or **User System Entry Point** (or other defined busbar). The performance requirements of the control system including slope (where applicable) shall be agreed between **The Company** and/or the relevant **Network Operator** and the **EU Generator**.

ECC.6.3.8.2 Voltage Control Requirements for Type B Power Park Modules

ECC.6.3.8.2.1 **The Company** or the relevant **Network Operator** will specify if the control system of the **Type B Power Park Module** shall contribute to voltage control or **Reactive Power** control or **Power Factor** control at the **Grid Entry Point** or **User System Entry Point** (or other defined busbar). The performance requirements of the control system including slope (where applicable) shall be agreed between **The Company** and/or the relevant **Network Operator** and the **EU Generator**.

ECC.6.3.8.3 Excitation Performance Requirements for Type C and Type D Onshore Synchronous Power Generating Modules

- ECC.6.3.8.3.1 Each **Synchronous Generating Unit** within a **Type C** and **Type D Onshore Synchronous Power Generating Modules** shall be equipped with a permanent automatic excitation control system that shall have the capability to provide constant terminal voltage control at a selectable setpoint without instability over the entire operating range of the **Synchronous Power Generating Module**.
- ECC.6.3.8.3.2 The requirements for excitation control facilities are specified in ECC.A.6. Any site specific requirements shall be specified by **The Company** or the relevant **Network Operator**.
- ECC.6.3.8.3.3 Unless otherwise required for testing in accordance with OC5.A.2, the automatic excitation control system of an **Onshore Synchronous Power Generating Module** shall always be operated such that it controls the **Onshore Synchronous Generating Unit** terminal voltage to a value that is
- equal to its rated value: or
 - only where provisions have been made in the **Bilateral Agreement**, greater than its rated value.
- ECC.6.3.8.3.4 In particular, other control facilities including constant **Reactive Power** output control modes and constant **Power Factor** control modes (but excluding VAR limiters) are not required. However if present in the excitation or voltage control system they will be disabled unless otherwise agreed with **The Company** or the relevant **Network Operator**. Operation of such control facilities will be in accordance with the provisions contained in **BC2**.
- ECC.6.3.8.3.5 The excitation performance requirements for **Offshore Synchronous Power Generating Modules** with an **Offshore Grid Entry Point** shall be specified by **The Company**.
- ECC.6.3.8.4 Voltage Control Performance Requirements for **Type C** and **Type D Onshore Power Park Modules, Onshore HVDC Converters** and **OTSDUW Plant and Apparatus** at the **Interface Point**
- ECC.6.3.8.4.1 Each **Type C** and **Type D Onshore Power Park Module, Onshore HVDC Converter** and **OTSDUW Plant and Apparatus** shall be fitted with a continuously acting automatic control system to provide control of the voltage at the **Grid Entry Point** or **User System Entry Point** (or **Interface Point** in the case of **OTSDUW Plant and Apparatus**) without instability over the entire operating range of the **Onshore Power Park Module, or Onshore HVDC Converter** or **OTSDUW Plant and Apparatus**. Any **Plant** or **Apparatus** used in the provisions of such voltage control within an **Onshore Power Park Module** may be located at the **Power Park Unit** terminals, an appropriate intermediate busbar or the **Grid Entry Point** or **User System Entry Point**. In the case of an **Onshore HVDC Converter** at a **HVDC Converter Station** any **Plant** or **Apparatus** used in the provisions of such voltage control may be located at any point within the **User's Plant and Apparatus** including the **Grid Entry Point** or **User System Entry Point**. **OTSDUW Plant and Apparatus** used in the provision of such voltage control may be located at the **Offshore Grid Entry Point** an appropriate intermediate busbar or at the **Interface Point**. When operating below 20% **Maximum Capacity** the automatic control system may continue to provide voltage control using any available reactive capability. If voltage control is not being provided, the automatic control system shall be designed to ensure a smooth transition between the shaded area below 20% of **Active Power** output and the non-shaded area above 20% of **Active Power** output in Figure ECC.6.3.2.4(c) and Figure ECC.6.3.2.6(b) The performance requirements for a continuously acting automatic voltage control system that shall be complied with by the **User** in respect of **Onshore Power Park Modules, Onshore HVDC Converters** at an **Onshore HVDC Converter Station, OTSDUW Plant and Apparatus** at the **Interface Point** are defined in ECC.A.7.

- ECC.6.3.8.4.3 In particular, other control facilities, including constant **Reactive Power** output control modes and constant **Power Factor** control modes (but excluding VAR limiters) are not required. However if present in the voltage control system they will be disabled unless otherwise agreed with **The Company** or the relevant **Network Operator**. Operation of such control facilities will be in accordance with the provisions contained in BC2. Where **Reactive Power** output control modes and constant **Power Factor** control modes have been fitted within the voltage control system they shall be required to satisfy the requirements of ECC.A.7.3 and ECC.A.7.4.
- ECC.6.3.8.5 Excitation Control Performance requirements applicable to AC Connected **Offshore Synchronous Power Generating Modules** and voltage control performance requirements applicable to AC connected **Offshore Power Park Modules, DC Connected Power Park Modules** and **Remote End HVDC Converters**
- ECC.6.3.8.5.1 A continuously acting automatic control system is required to provide control of **Reactive Power** (as specified in ECC.6.3.2.5 and ECC.6.3.2.6) at the **Offshore Grid Entry Point** (or **HVDC Interface Point** in the case of **Configuration 1 DC Connected Power Park Modules** and **Remote End HVDC Converters**) without instability over the entire operating range of the AC connected **Offshore Synchronous Power Generating Module** or **Configuration 1 AC connected Offshore Power Park Module** or **Configuration 1 DC Connected Power Park Modules** or **Remote End HVDC Converter**. The performance requirements for this automatic control system will be specified by **The Company** which would be consistent with the requirements of ECC.6.3.2.5 and ECC.6.3.2.6.
- ECC.6.3.8.5.2 A continuously acting automatic control system is required to provide control of **Reactive Power** (as specified in ECC.6.3.2.8) at the **Offshore Grid Entry Point** (or **HVDC Interface Point** in the case of **Configuration 2 DC Connected Power Park Modules**) without instability over the entire operating range of the **Configuration 2 AC connected Offshore Power Park Module** or **Configuration 2 DC Connected Power Park Modules**. otherwise the requirements of ECC.6.3.2.6 shall apply. The performance requirements for this automatic control system are specified in ECC.A.8
- ECC.6.3.8.5.3 In addition to ECC.6.3.8.5.1 and ECC.6.3.8.5.2 the requirements for excitation or voltage control facilities, including **Power System Stabilisers**, where these are necessary for system reasons, will be specified by **The Company**. Reference is made to on-load commissioning witnessed by **The Company** in BC2.11.2.
- ECC.6.3.9 STEADY STATE LOAD INACCURACIES
- ECC.6.3.9.1 The standard deviation of **Load** error at steady state **Load** over a 30 minute period must not exceed 2.5 per cent of a **Type C** or **Type D Power Generating Modules** (including a **DC Connected Power Park Module**) **Maximum Capacity**. Where a **Type C** or **Type D Power Generating Module** (including a **DC Connected Power Park Module**) is instructed to **Frequency** sensitive operation, allowance will be made in determining whether there has been an error according to the governor droop characteristic registered under the **PC**.
- For the avoidance of doubt in the case of a **Power Park Module** (excluding a **Non-Synchronous Electricity Storage Module**) an allowance will be made for the full variation of mechanical power output.
- In the case of an **Electricity Storage Module**, an allowance will be made for the storage reserve capability of the **Electricity Storage Module**.
- ECC.6.3.10 NEGATIVE PHASE SEQUENCE LOADINGS
- ECC.6.3.10.1 In addition to meeting the conditions specified in ECC.6.1.5(b), each **Synchronous Power Generating Module** will be required to withstand, without tripping, the negative phase sequence loading incurred by clearance of a close-up phase-to-phase fault, by **System Back-Up Protection** on the **National Electricity Transmission System** or **User System** located **Onshore** in which it is **Embedded**.
- ECC.6.3.11 NEUTRAL EARTHING

- ECC.6.3.11 At nominal **System** voltages of 110kV and above the higher voltage windings of a transformer of a **Power Generating Module** or **HVDC Equipment** or transformer resulting from **OTSDUW** must be star connected with the star point suitable for connection to earth. The earthing and lower voltage winding arrangement shall be such as to ensure that the **Earth Fault Factor** requirement of paragraph ECC.6.2.1.1 (b) will be met on the **National Electricity Transmission System** at nominal **System** voltages of 110kV and above.
- ECC.6.3.12 FREQUENCY AND VOLTAGE DEVIATIONS
- ECC.6.3.12.1 As stated in ECC.6.1.2, the **System Frequency** could rise to 52Hz or fall to 47Hz. Each **Power Generating Module** (including **DC Connected Power Park Modules**) must continue to operate within this **Frequency** range for at least the periods of time given in ECC.6.1.2 unless **The Company** has specified any requirements for combined **Frequency** and voltage deviations which are required to ensure the best use of technical capabilities of **Power Generating Modules** (including **DC Connected Power Park Modules**) if required to preserve or restore system security.- Notwithstanding this requirement, **EU Generators** should also be aware of the requirements of ECC.6.3.13.
- ECC.6.3.13 FREQUENCY, RATE OF CHANGE OF FREQUENCY AND VOLTAGE PROTECTION SETTING ARRANGEMENTS
- ECC.6.3.13.1 **EU Generators** (including in respect of **OTSDUW Plant and Apparatus**) and **HVDC System Owners** will be responsible for protecting all their **Power Generating Modules** (and **OTSDUW Plant and Apparatus**) or **HVDC Equipment** against damage should **Frequency** excursions outside the range 52Hz to 47Hz ever occur. Should such excursions occur, it is up to the **EU Generator** or **HVDC System Owner** to decide whether to disconnect their **Apparatus** for reasons of safety of **Apparatus, Plant** and/or personnel.
- ECC.6.3.13.2 Each **Power Park Module** with a **Grid Forming Capability** as provided for in ECC.6.3.19, when connected and synchronised to the **System**, is required to be capable of withstanding without tripping a rate of change of **Frequency** up to and including 2 Hz per second as measured over a rolling 500 milliseconds period. All other **Power Generating Modules** when connected and synchronised to the **System**, shall be capable of withstanding without tripping a rate of change of **Frequency** up to and including 1 Hz per second as measured over a rolling 500 milliseconds period. Voltage dips may cause localised rate of change of **Frequency** values in excess of 1 Hz per second (or 2Hz/s in the case of **Power Park Modules** with a **Grid Forming Capability**) for short periods, and in these cases, the requirements under ECC.6.3.15 (fault ride through) supersedes this clause. For the avoidance of doubt, this requirement relates to the capabilities of **Power Generating Modules** only and does not impose the need for rate of change of **Frequency** protection nor does it impose a specific setting for anti-islanding or loss-of-mains protection relays.
- ECC.6.3.13.3 Each **HVDC System** and **Remote End HVDC Converter Station** when connected and synchronised to the **System**, shall be capable of withstanding without tripping a rate of change of **Frequency** up to and including ± 2.5 Hz per second as measured over the previous 1 second period. Voltage dips may cause localised rate of change of **Frequency** values in excess of ± 2.5 Hz per second for short periods, and in these cases, the requirements under ECC.6.3.15 (fault ride through) supersedes this clause. For the avoidance of doubt, this requirement relates to the capabilities of **HVDC Systems** and **Remote End HVDC Converter Stations** only and does not impose the need for rate of change of **Frequency** protection nor does it impose a specific setting for anti-islanding or loss-of-mains protection relays.
- ECC.6.3.13.4 Each **DC Connected Power Park Module** when connected to the **System**, shall be capable of withstanding without tripping a rate of change of **Frequency** up to and including ± 2.0 Hz per second as measured over the previous 1 second period. **Voltage** dips may cause localised rate of change of **Frequency** values in excess of ± 2.0 Hz per second for short periods, and in these cases, the requirements under ECC.6.3.15 (fault ride through) supersedes this clause. For the avoidance of doubt, this requirement relates to the capabilities of **DC Connected Power Park Modules** only and does not impose the need for rate of change of **Frequency** protection nor does it impose a specific setting for anti-islanding or loss-of-mains protection relays.

- ECC.6.3.13.5 As stated in ECC.6.1.2, the **System Frequency** could rise to 52Hz or fall to 47Hz and the **System** voltage at the **Grid Entry Point** or **User System Entry Point** could rise or fall within the values outlined in ECC.6.1.4. Each **Type C** and **Type D Power Generating Module** (including **DC Connected Power Park Modules**) or any constituent element must continue to operate within this **Frequency** range for at least the periods of time given in ECC.6.1.2 and voltage range as defined in ECC.6.1.4 unless **The Company** has agreed to any simultaneous overvoltage and underfrequency relays and/or simultaneous undervoltage and over frequency relays which will trip such **Power Generating Module** (including **DC Connected Power Park Modules**), and any constituent element within this **Frequency** or voltage range. In the case of **Grid Forming Plant**, **Grid Forming Plant Owners** are also required to satisfy the **System Frequency** and **System** voltage requirements as defined in ECC.6.3.19.
- ECC.6.3.14 FAST START CAPABILITY
- ECC.6.3.14.1 It may be agreed in the **Bilateral Agreement** that a **Genset** shall have a **Fast-Start Capability**. Such **Gensets** may be used for **Operating Reserve** and their **Start-Up** may be initiated by **Frequency-level** relays with settings in the range 49Hz to 50Hz as specified pursuant to **OC2**.
- ECC.6.3.15 FAULT RIDE THROUGH
- ECC.6.3.15.1 General **Fault Ride Through** requirements, principles and concepts applicable to **Type B**, **Type C** and **Type D Power Generating Modules** and **OTSDUW Plant and Apparatus** subject to faults up to 140ms in duration
- ECC.6.3.15.1.1 ECC.6.3.15.1 – ECC.6.3.15.8 section sets out the **Fault Ride Through** requirements on **Type B**, **Type C** and **Type D Power Generating Modules**, **OTSDUW Plant and Apparatus** and **HVDC Equipment** that shall apply in the event of a fault lasting up to 140ms in duration.
- ECC.6.3.15.1.2 Each **Power Generating Module**, **Power Park Module**, **HVDC Equipment** and **OTSDUW Plant and Apparatus** is required to remain connected and stable for any balanced and unbalanced fault where the voltage at the **Grid Entry Point** or **User System Entry Point** or (**HVDC Interface Point** in the case of **Remote End DC Converter Stations** or **Interface Point** in the case of **OTSDUW Plant and Apparatus**) remains on or above the heavy black line defined in sections ECC.6.3.15.2 – ECC.6.3.15.7 below. For up to 30 minutes following such a fault event each **Power Generating Module**, **Power Park Module**, **HVDC Equipment** and **OTSDUW Plant and Apparatus** is required to remain connected and stable provided **System** operating conditions have returned within those specified in ECC.6.1.
- ECC.6.3.15.1.3 The voltage against time curves defined in ECC.6.3.15.2 – ECC.6.3.15.7 expresses the lower limit (expressed as the ratio of its actual value and its reference 1pu) of the actual course of the phase to phase voltage (or phase to earth voltage in the case of asymmetrical/unbalanced faults) on the **System** voltage level at the **Grid Entry Point** or **User System Entry Point** (or **HVDC Interface Point** in the case of **Remote End HVDC Converter Stations** or **Interface Point** in the case of **OTSDUW Plant and Apparatus**) during a symmetrical or asymmetrical/unbalanced fault, as a function of time before, during and after the fault.
- ECC.6.3.15.2 Voltage against time curve and parameters applicable to **Type B Synchronous Power Generating Modules**

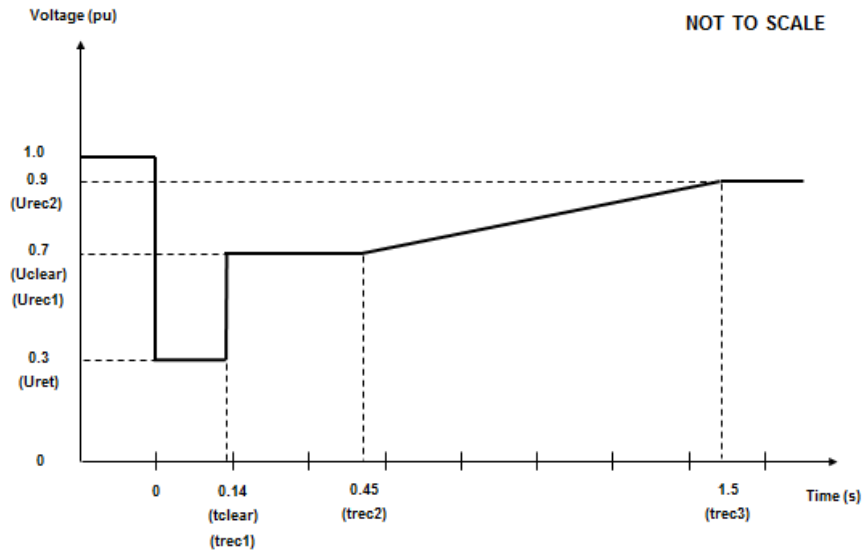

Figure ECC.6.3.15.2 - Voltage against time curve applicable to **Type B Synchronous Power Generating Modules**

Voltage parameters (pu)		Time parameters (seconds)	
Uret	0.3	tclear	0.14
Uclear	0.7	trec1	0.14
Urec1	0.7	trec2	0.45
Urec2	0.9	trec3	1.5

Table ECC.6.3.15.2 Voltage against time parameters applicable to **Type B Synchronous Power Generating Modules**

ECC.6.3.15.3 **Voltage against time curve and parameters applicable to Type C and D Synchronous Power Generating Modules connected below 110kV**

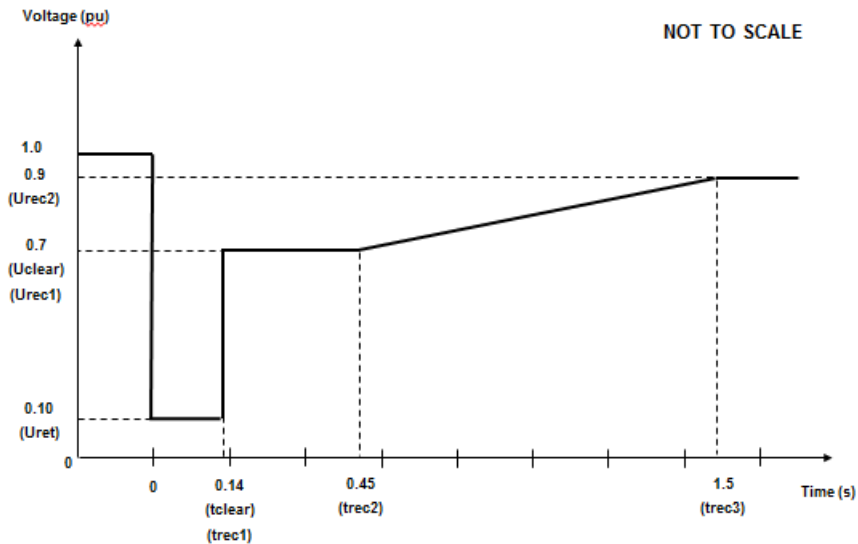

Figure ECC.6.3.15.3 - Voltage against time curve applicable to **Type C and D Synchronous Power Generating Modules** connected below 110kV

Voltage parameters (pu)		Time parameters (seconds)	
Uret	0.1	tclear	0.14
Uclear	0.7	trec1	0.14
Urec1	0.7	trec2	0.45
Urec2	0.9	trec3	1.5

Table ECC.6.3.15.3 Voltage against time parameters applicable to **Type C and D Synchronous Power Generating Modules** connected below 110kV

ECC.6.3.15.4 Voltage against time curve and parameters applicable to **Type D Synchronous Power Generating Modules** connected at or above 110kV

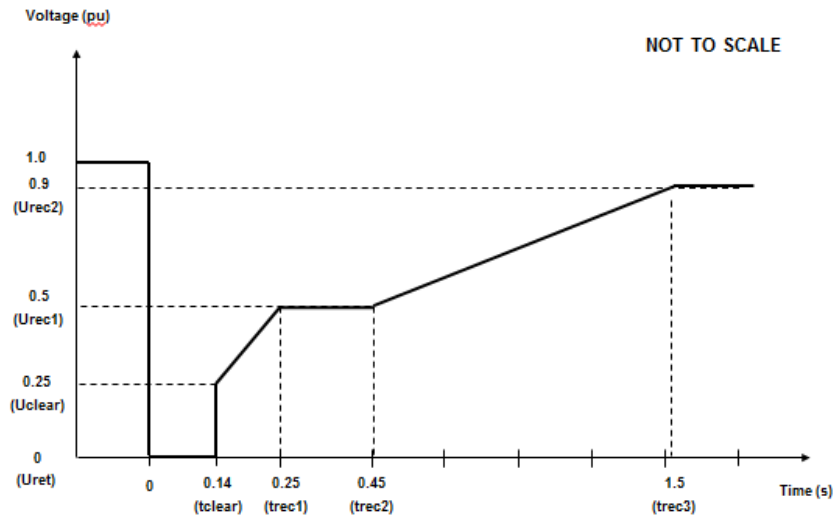

Figure ECC.6.3.15.4 - Voltage against time curve applicable to **Type D Synchronous Power Generating Modules** connected at or above 110kV

Voltage parameters (pu)		Time parameters (seconds)	
Uret	0	tclear	0.14
Uclear	0.25	trec1	0.25
Urec1	0.5	trec2	0.45
Urec2	0.9	trec3	1.5

Table ECC.6.3.15.4 Voltage against time parameters applicable to **Type D Synchronous Power Generating Modules** connected at or above 110kV

ECC.6.3.15.5 Voltage against time curve and parameters applicable to **Type B, C and D Power Park Modules** connected below 110kV

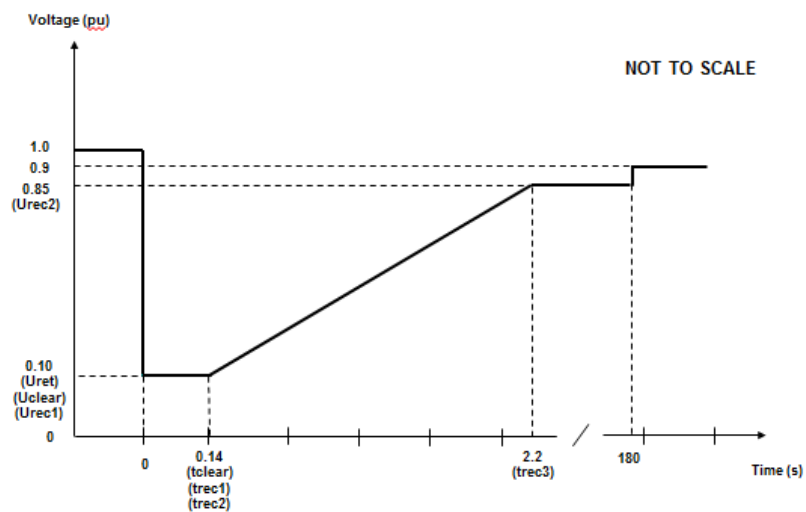

Figure ECC.6.3.15.5 - Voltage against time curve applicable to **Type B, C and D Power Park Modules** connected below 110kV

Voltage parameters (pu)		Time parameters (seconds)	
Uret	0.10	tclear	0.14

Uclear	0.10	trec1	0.14
Urec1	0.10	trec2	0.14
Urec2	0.85	trec3	2.2

Table ECC.6.3.15.5 Voltage against time parameters applicable to **Type B, C and D Power Park Modules** connected below 110kV

ECC.6.3.15.6 Voltage against time curve and parameters applicable to **Type D Power Park Modules** with a **Grid Entry Point** or **User System Entry Point** at or above 110kV, **DC Connected Power Park Modules** at the **HVDC Interface Point** or **OTSDUW Plant and Apparatus** at the **Interface Point**.

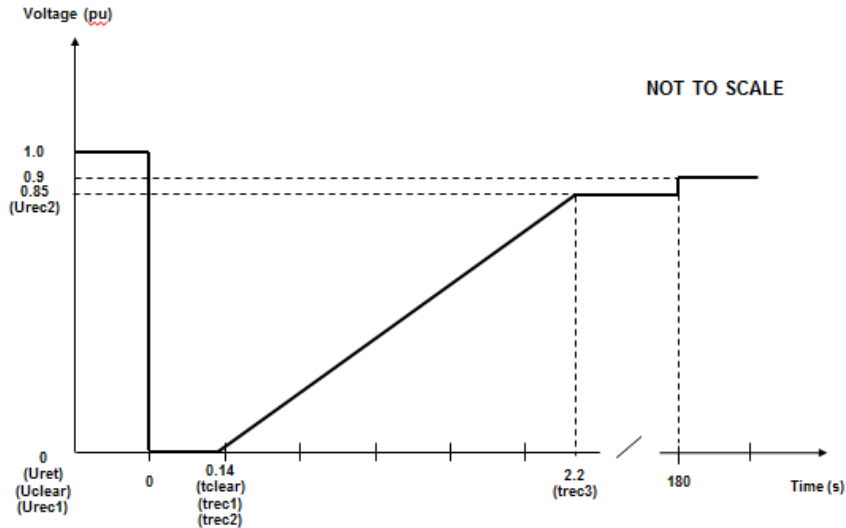

Figure ECC.6.3.15.6 - Voltage against time curve applicable to **Type D Power Park Modules** with a **Grid Entry Point** or **User System Entry Point** at or above 110kV, **DC Connected Power Park Modules** at the **HVDC Interface Point** or **OTSDUW Plant and Apparatus** at the **Interface Point**.

Voltage parameters (pu)		Time parameters (seconds)	
Uret	0	tclear	0.14
Uclear	0	trec1	0.14
Urec1	0	trec2	0.14
Urec2	0.85	trec3	2.2

Table ECC.6.3.15.6 Voltage against time parameters applicable to a **Type D Power Park Modules** with a **Grid Entry Point** or **User System Entry Point** at or above 110kV, **DC Connected Power Park Modules** at the **HVDC Interface Point** or **OTSDUW Plant and Apparatus** at the **Interface Point**.

ECC.6.3.15.7 Voltage against time curve and parameters applicable to **HVDC Systems** and **Remote End HVDC Converter Stations**

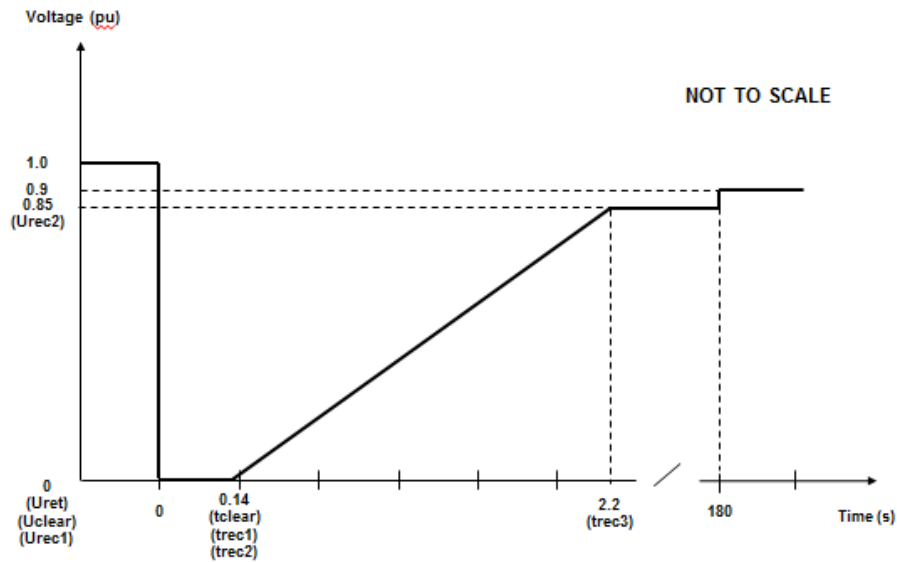

Figure ECC.6.3.15.7 - Voltage against time curve applicable to **HVDC Systems** and **Remote End HVDC Converter Stations**

Voltage parameters (pu)		Time parameters (seconds)	
Uret	0	tclear	0.14
Uclear	0	trec1	0.14
Urec1	0	trec2	0.14
Urec2	0.85	trec3	2.2

Table ECC.6.3.15.7 Voltage against time parameters applicable to **HVDC Systems** and **Remote End HVDC Converter Stations**

ECC.6.3.15.8

In addition to the requirements in ECC.6.3.15.1 – ECC.6.3.15.7:

- (i) Each **Type B, Type C** and **Type D Power Generating Module** at the **Grid Entry Point** or **User System Entry Point**, **HVDC Equipment** (or **OTSDUW Plant and Apparatus** at the **Interface Point**) shall be capable of satisfying the above requirements when operating at **Rated MW** output and maximum leading **Power Factor**.
- (ii) **The Company** will specify upon request by the **User** the pre-fault and post fault short circuit capacity (in MVA) at the **Grid Entry Point** or **User System Entry Point** (or **HVDC Interface Point** in the case of a remote end **HVDC Converter Stations** or **Interface Point** in the case of **OTSDUW Plant and Apparatus**).
- (iii) The pre-fault voltage shall be taken to be 1.0pu and the post fault voltage shall not be less than 0.9pu.
- (iv) To allow a **User** to model the **Fault Ride Through** performance of its **Type B, Type C** and/or **Type D Power Generating Modules** or **HVDC Equipment**, **The Company** will provide additional network data as may reasonably be required by the **EU Code User** to undertake such study work in accordance with PC.A.8. Alternatively, **The Company** may provide generic values derived from typical cases.
- (v) **The Company** will publish fault level data under maximum and minimum demand conditions in the **Electricity Ten Year Statement**.

- (vi) Each **EU Generator** (in respect of **Type B, Type C, Type D Power Generating Modules** and **DC Connected Power Park Modules**) and **HVDC System Owners** (in respect of **HVDC Systems**) shall satisfy the requirements in ECC.6.3.15.8(i) – (vii) unless the protection schemes and settings for internal electrical faults trips the **Type B, Type C** and **Type D Power Generating Module, HVDC Equipment** (or **OTSDUW Plant and Apparatus**) from the **System**. The protection schemes and settings should not jeopardise **Fault Ride Through** performance as specified in ECC.6.3.15.8(i) – (vii). The undervoltage protection at the **Grid Entry Point** or **User System Entry Point** (or **HVDC Interface Point** in the case of a **Remote End HVDC Converter Stations** or **Interface Point** in the case of **OTSDUW Plant and Apparatus**) shall be set by the **EU Generator** (or **HVDC System Owner** or **OTSDUA** in the case of **OTSDUW Plant and Apparatus**) according to the widest possible range unless **The Company** and the **EU Code User** have agreed to narrower settings. All protection settings associated with undervoltage protection shall be agreed between the **EU Generator** and/or **HVDC System Owner** with **The Company** and **Relevant Transmission Licensee's** and relevant **Network Operator** (as applicable).
- (vii) Each **Type B, Type C** and **Type D Power Generating Module, HVDC System** and **OTSDUW Plant and Apparatus** at the **Interface Point** shall be designed such that upon clearance of the fault on the **Onshore Transmission System** and within 0.5 seconds of restoration of the voltage at the **Grid Entry Point** or **User System Entry Point** or **HVDC Interface Point** in the case of a **Remote End HVDC Converter Stations** or **Interface Point** in the case of **OTSDUW Plant and Apparatus** to 90% of nominal voltage or greater, **Active Power** output (or **Active Power** transfer capability in the case of **OTSDW Plant and Apparatus** or **Remote End HVDC Converter Stations**) shall be restored to at least 90% of the level immediately before the fault. Once **Active Power** output (or **Active Power** transfer capability in the case of **OTSDUW Plant and Apparatus** or **Remote End HVDC Converter Stations**) has been restored to the required level, **Active Power** oscillations shall be acceptable provided that:
- The total **Active Energy** delivered during the period of the oscillations is at least that which would have been delivered if the **Active Power** was constant
 - The oscillations are adequately damped.
 - In the event of power oscillations, **Power Generating Modules** shall retain steady state stability when operating at any point on **the Power Generating Module Performance Chart**.
- For AC Connected **Onshore** and **Offshore Power Park Modules** comprising switched reactive compensation equipment (such as mechanically switched capacitors and reactors), such switched reactive compensation equipment shall be controlled such that it is not switched in or out of service during the fault but may act to assist in post fault voltage recovery.

- ECC.6.3.15.9 General Fault Ride Through requirements for faults in excess of 140ms in duration.
- ECC.6.3.15.9.1 General Fault Ride Through requirements applicable to HVDC Equipment and OTSDUW DC Converters subject to faults and voltage dips in excess of 140ms.
- ECC.6.3.15.9.1.1 The requirements applicable to **HVDC Equipment** including **OTSDUW DC Converters** subject to faults and voltage disturbances at the **Grid Entry Point** or **User System Entry Point** or **Interface Point** or **HVDC Interface Point**, including **Active Power** transfer capability shall be specified in the **Bilateral Agreement**.
- ECC.6.3.15.9.2 Fault Ride Through requirements for Type C and Type D Synchronous Power Generating Modules and Type C and Type D Power Park Modules and OTSDUW Plant and Apparatus subject to faults and voltage disturbances on the Onshore Transmission System in excess of 140ms

ECC.6.3.15.9.2.1 The **Fault Ride Through** requirements for **Type C** and **Type D Synchronous Power Generating Modules** subject to faults and voltage disturbances on the Onshore Transmission System in excess of 140ms are defined in ECC.6.3.15.9.2.1(a) and the **Fault Ride Through Requirements for Type C and Type D Power Park Modules and OTSDUW Plant and Apparatus** subject to faults and voltage disturbances on the Onshore Transmission System greater than 140ms in duration are defined in ECC.6.3.15.9.2.1(b).

- (a) Requirements applicable to **Synchronous Power Generating Modules** subject to **Supergrid Voltage** dips on the **Onshore Transmission System** greater than 140ms in duration.

In addition to the requirements of ECC.6.3.15.1 – ECC.6.3.15.8 each **Synchronous Power Generating Module** shall:

- (i) remain transiently stable and connected to the **System** without tripping of any **Synchronous Power Generating Module** for balanced **Supergrid Voltage** dips and associated durations on the **Onshore Transmission System** (which could be at the **Interface Point**) anywhere on or above the heavy black line shown in Figure ECC.6.3.15.9(a) Appendix 4 and Figures EA.4.3.2(a), (b) and (c) provide an explanation and illustrations of Figure ECC.6.3.15.9(a); and,

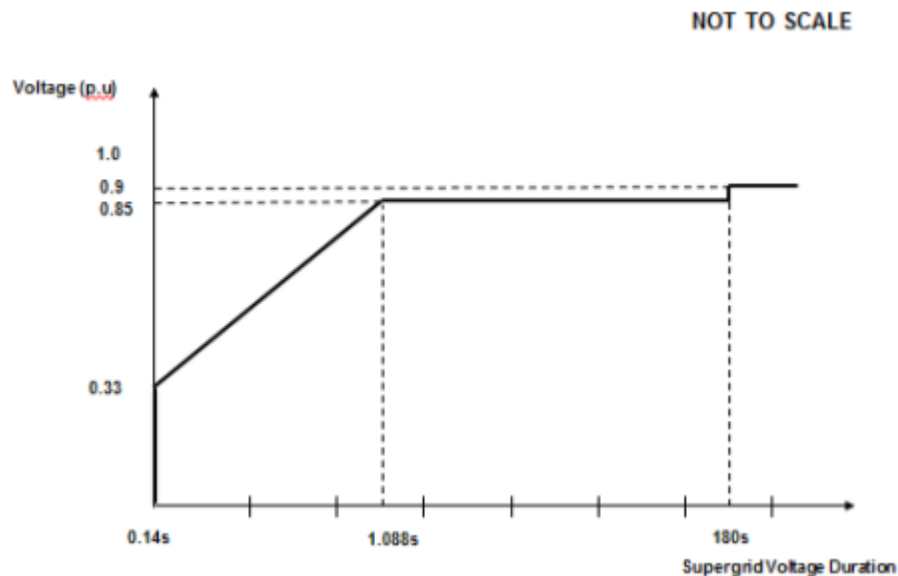

Figure ECC.6.3.15.9(a)

- (ii) provide **Active Power** output at the **Grid Entry Point**, during **Supergrid Voltage** dips on the **Onshore Transmission System** as described in Figure ECC.6.3.15.9(a), at least in proportion to the retained balanced voltage at the **Onshore Grid Entry Point** (for **Onshore Synchronous Power Generating Modules**) or **Interface Point** (for **Offshore Synchronous Power Generating Modules**) (or the retained balanced voltage at the **User System Entry Point** if **Embedded**) and shall generate maximum reactive current (where the voltage at the **Grid Entry Point** is outside the limits specified in ECC.6.1.4) without exceeding the transient rating limits of the **Synchronous Power Generating Module** and,
- (iii) restore **Active Power** output following **Supergrid Voltage** dips on the **Onshore Transmission System** as described in Figure ECC.6.3.15.9(a), within 1 second of restoration of the voltage to 1.0pu of the nominal voltage at the:

Onshore Grid Entry Point for directly connected **Onshore Synchronous Power Generating Modules** or,

Interface Point for **Offshore Synchronous Power Generating Modules**
or,

User System Entry Point for **Embedded Onshore Synchronous Power Generating Modules**

or,
User System Entry Point for Embedded Medium Power Stations not subject to a **Bilateral Agreement** which comprise **Synchronous Generating Units** and with an **Onshore User System Entry Point** (irrespective of whether they are located **Onshore** or **Offshore**)

to at least 90% of the level available immediately before the occurrence of the dip. Once the **Active Power** output has been restored to the required level, **Active Power** oscillations shall be acceptable provided that:

- the total **Active Energy** delivered during the period of the oscillations is at least that which would have been delivered if the **Active Power** was constant
- the oscillations are adequately damped.

For the avoidance of doubt a balanced **Onshore Transmission System Supergrid Voltage** meets the requirements of ECC.6.1.5 (b) and ECC.6.1.6.

(iv) For up to 30 minutes following such a **Supergrid Voltage** dip on the **Onshore Transmission System** each **Synchronous Power Generating Module** is required to remain connected and stable provided **System** operating conditions have returned within those specified in ECC.6.1

- (b) Requirements applicable to **Type C** and **Type D Power Park Modules** and **OTSDUW Plant and Apparatus** (excluding **OTSDUW DC Converters**) subject to **Supergrid Voltage** dips on the **Onshore Transmission System** greater than 140ms in duration.

In addition to the requirements of ECC.6.3.15.5, ECC.6.3.15.6 and ECC.6.3.15.8 (as applicable) each **OTSDUW Plant and Apparatus** or each **Power Park Module** and / or any constituent **Power Park Unit**, shall:

- (i) remain transiently stable and connected to the **System** without tripping of any **OTSDUW Plant and Apparatus**, or **Power Park Module** and / or any constituent **Power Park Unit**, for balanced **Supergrid Voltage** dips and associated durations on the **Onshore Transmission System** (which could be at the **Interface Point**) anywhere on or above the heavy black line shown in Figure ECC.6.3.15.9(b). Appendix 4 and Figures EA.4.3.4 (a), (b) and (c) provide an explanation and illustrations of Figure ECC.6.3.15.9(b) ; and,

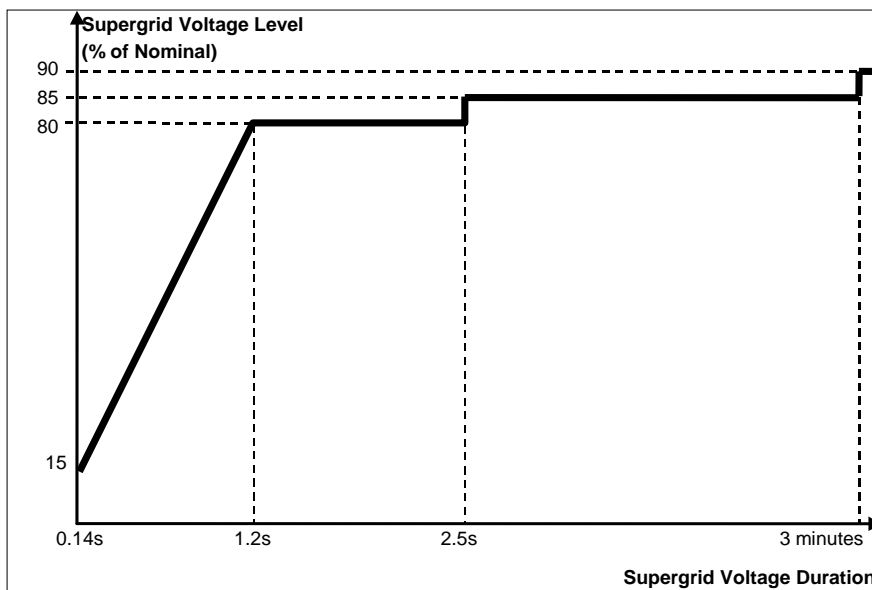

Figure ECC.6.3.15.9(b)

- (ii) be required to satisfy the requirements of ECC.6.3.16. In the case of a **Non-Synchronous Generating Unit** or **OTSDUW Plant and Apparatus** or **Power Park Module** where there has been a reduction in the **Intermittent Power Source** or in the case of **OTSDUW Active Power** transfer capability in the time range in Figure ECC.6.3.15.9(b) an allowance shall be made for the fall in input power and the

corresponding reduction of real and reactive current.

- (iii) restore **Active Power** output (or, in the case of **OTSDUW, Active Power** transfer capability), following **Supergrid Voltage** dips on the **Onshore Transmission System** as described in Figure ECC.6.3.15.9(b), within 1 second of restoration of the voltage to 0.9 pu of the nominal voltage at the:

Onshore Grid Entry Point for directly connected **Onshore Power Park Modules** or,

Interface Point for **OTSDUW Plant and Apparatus** and **Offshore Power Park Modules** or,

User System Entry Point for **Embedded Onshore Power Park Modules** or ,

User System Entry Point for **Embedded Medium Power Stations** which comprise **Power Park Modules** not subject to a **Bilateral Agreement** and with an **Onshore User System Entry Point** (irrespective of whether they are located **Onshore** or **Offshore**)

to at least 90% of the level available immediately before the occurrence of the dip except in the case of a **Non-Synchronous Generating Unit, OTSDUW Plant and Apparatus** or **Power Park Module** where there has been a reduction in the **Intermittent Power Source** in the time range in Figure ECC.6.3.15.9(b) that restricts the **Active Power** output or, in the case of **OTSDUW, Active Power** transfer capability below this level. Once the **Active Power** output or, in the case of **OTSDUW, Active Power** transfer capability has been restored to the required level, **Active Power** oscillations shall be acceptable provided that:

- the total **Active Energy** delivered during the period of the oscillations is at least that which would have been delivered if the **Active Power** was constant
- the oscillations are adequately damped.

For the avoidance of doubt a balanced **Onshore Transmission System Supergrid Voltage** meets the requirements of ECC.6.1.5 (b) and ECC.6.1.6.

- (iv) For up to 30 minutes following such a **Supergrid Voltage** dip on the **Onshore Transmission System** each **Power Park Module** and / or any constituent **Power Park Unit** and **OTSDUW Plant and Apparatus** is required to remain connected and stable provided **System** operating conditions have returned within those specified in ECC.6.1.

ECC.6.3.15.10 Other Fault Ride Through Requirements

- (i) In the case of a **Power Park Module** (excluding **Non-Synchronous Electricity Storage Modules**), the requirements in ECC.6.3.15.9 do not apply when the **Power Park Module** (excluding **Non-Synchronous Electricity Storage Modules**) is operating at less than 5% of its **Rated MW** or during very high primary energy source conditions when more than 50% of the **Power Park Units** in a **Power Park Module** have been shut down or disconnected under an emergency shutdown sequence to protect **User's Plant** and **Apparatus**.
- (ii) In addition to meeting the conditions specified in ECC.6.1.5(b) and ECC.6.1.6, each **Non-Synchronous Generating Unit, OTSDUW Plant and Apparatus** or **Power Park Module** and any constituent **Power Park Unit** thereof will be required to withstand, without tripping, the negative phase sequence loading incurred by clearance of a close-up phase-to-phase fault, by **System Back-Up Protection** on the **Onshore Transmission System** operating at **Supergrid Voltage**.

- (iii) **Generators** in respect of **Type B, Type C and Type D Power Park Modules** and **HVDC System Owners** are required to confirm to **The Company**, their repeated ability to operate through balanced and unbalanced faults and **System** disturbances each time the voltage at the **Grid Entry Point** or **User System Entry Point** falls outside the limits specified in ECC.6.1.4. Demonstration of this capability would be satisfied by **EU Generators** and **HVDC System Owners** supplying the protection settings of their plant, informing **The Company** of the maximum number of repeated operations that can be performed under such conditions and any limiting factors to repeated operation such as protection or thermal rating; and
- (iv) Notwithstanding the requirements of ECC.6.3.15(v), **Power Generating Modules** shall be capable of remaining connected during single phase or three phase auto-reclosures to the **National Electricity Transmission System** and operating without power reduction as long as the voltage and frequency remain within the limits defined in ECC.6.1.4 and ECC.6.1.2; and
- (v) For the avoidance of doubt the requirements specified in ECC.6.3.15 do not apply to **Power Generating Modules** connected to either an unhealthy circuit and/or islanded from the **Transmission System** even for delayed auto reclosure times.
- (vi) To avoid unwanted island operation, **Non-Synchronous Generating Units** in Scotland (and those directly connected to a **Scottish Offshore Transmission System**), **Power Park Modules** in Scotland (and those directly connected to a **Scottish Offshore Transmission System**), or **OTSDUW Plant and Apparatus** with an **Interface Point** in Scotland shall be tripped for the following conditions:
 - (1) **Frequency** above 52Hz for more than 2 seconds
 - (2) **Frequency** below 47Hz for more than 2 seconds
 - (3) Voltage as measured at the **Onshore Connection Point** or **Onshore User System Entry Point** or **Offshore Grid Entry Point** or **Interface Point** in the case of **OTSDUW Plant and Apparatus** is below 80% for more than 2.5 seconds

Voltage as measured at the **Onshore Connection Point** or **Onshore User System Entry Point** or **Offshore Grid Entry Point** or **Interface Point** in the case of **OTSDUW Plant and Apparatus** is above 120% (115% for 275kV) for more than 1 second. The times in sections (1) and (2) are maximum trip times. Shorter times may be used to protect the **Non-Synchronous Generating Units**, or **OTSDUW Plant and Apparatus**.

ECC.6.3.15.11 HVDC System Robustness

ECC.6.3.15.11.1 The **HVDC System** shall be capable of finding stable operation points with a minimum change in **Active Power** flow and voltage level, during and after any planned or unplanned change in the **HVDC System** or **AC System** to which it is connected. **The Company** shall specify the changes in the System conditions for which the **HVDC Systems** shall remain in stable operation.

ECC.6.3.15.11.2 The **HVDC System** owner shall ensure that the tripping or disconnection of an **HVDC Converter Station**, as part of any multi-terminal or embedded **HVDC System**, does not result in transients at the **Grid Entry Point** or **User System Entry Point** beyond the limit specified by **The Company** in co-ordination with the **Relevant Transmission Licensee**.

ECC.6.3.15.11.3 The **HVDC System** shall withstand transient faults on HVAC lines in the network adjacent or close to the **HVDC System**, and shall not cause any of the equipment in the **HVDC System** to disconnect from the network due to autoreclosure of lines in the **System**.

ECC.6.3.15.11.4 The **HVDC System Owner** shall provide information to **The Company** on the resilience of the **HVDC System** to **AC System** disturbances.

ECC.6.3.16 FAST FAULT CURRENT INJECTION

ECC.6.3.16.1 General Fast Fault Current injection, principles and concepts applicable to Type B, Type C and Type D Power Park Modules and HVDC Equipment

ECC.6.3.16.1.1 In addition to the requirements of ECC.6.1.4, ECC.6.3.2, ECC.6.3.8 and ECC.A.7, each **Type B, Type C and Type D Power Park Module** or each **Power Park Unit** within a **Type B, Type C and Type D Power Park Module** or **HVDC Equipment** shall be required to satisfy the following requirements unless operating in a **Grid Forming Capability** mode in which case the requirements of ECC.6.3.19 shall apply instead. For the purposes of this requirement, current and voltage are assumed to be positive phase sequence values.

ECC.6.3.16.1.2 For any balanced fault which results in the positive phase sequence voltage falling below the voltage levels specified in ECC.6.1.4 at the **Grid Entry Point** or **User System Entry Point** (if **Embedded**), each **Type B, Type C and Type D Power Park Module** or each **Power Park Unit** within a **Type B, Type C and Type D Power Park Module** or **HVDC Equipment** shall, as a minimum (unless an alternative type registered solution has otherwise been agreed with **The Company**), be required to inject a reactive current above the heavy black line shown in Figure ECC.16.3.16(a)

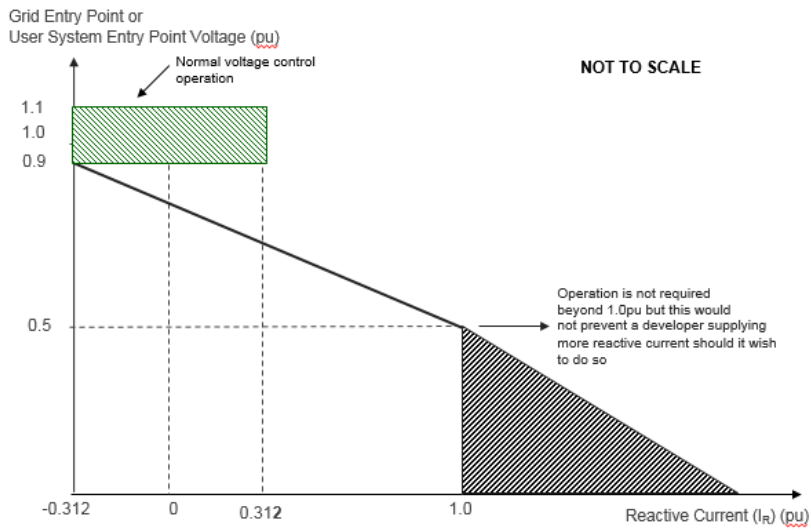

Figure ECC.6.3.16(a)

ECC.6.3.16.1.3 Figure ECC.6.3.16(a) defines the reactive current (I_R) to be supplied under a faulted condition which shall be dependent upon the pre-fault operating condition and the retained voltage at the **Grid Entry Point** or **User System Entry Point** voltage. For the avoidance of doubt, each **Power Park Module** (and any constituent element thereof) or **HVDC Equipment**, shall be required to inject a reactive current (I_R) which shall be not less than its pre-fault reactive current and which shall as a minimum increase with the fall in the retained voltage each time the voltage at the **Grid Entry Point** or **User System Entry Point** (if **Embedded**) falls below 0.9pu whilst ensuring the overall rating of the **Power Park Module** (or constituent element thereof) or **HVDC Equipment** shall not be exceeded.

ECC.6.3.16.1.4 In addition to the requirements of ECC.6.3.16.1.2 and ECC.6.3.16.1.3, each **Type B, Type C and Type D Power Park Module** or each **Power Park Unit** within a **Type B, Type C and Type D Power Park Module** or **HVDC Equipment** shall be required to inject reactive current above the shaded area shown in Figure ECC.6.3.16(b) and Figure ECC.6.3.16(c) which illustrates how the reactive current shall be injected over time from fault inception in which the value of I_R is determined from Figure ECC.6.3.16(a). In figures ECC.6.3.16(b) and ECC.6.3.16(c) ΔI_R is the value of the reactive current (I_R) less the pre-fault current. In this context fault inception is taken to be when the voltage at the **Grid Entry Point** or **User System Entry Point** falls below 0.9pu.

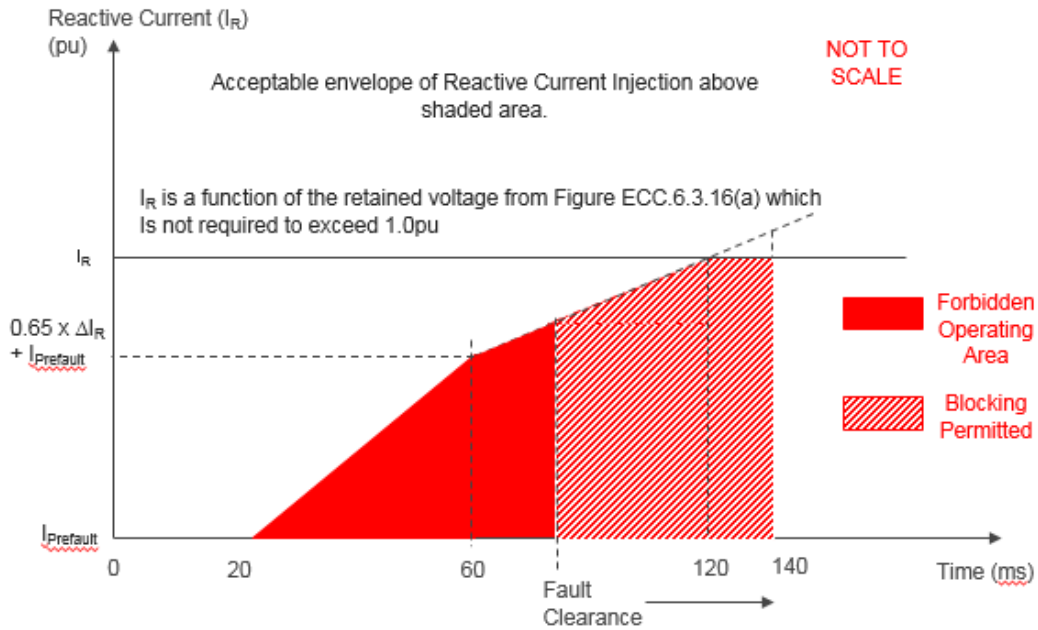

Figure ECC.16.3.16(b)

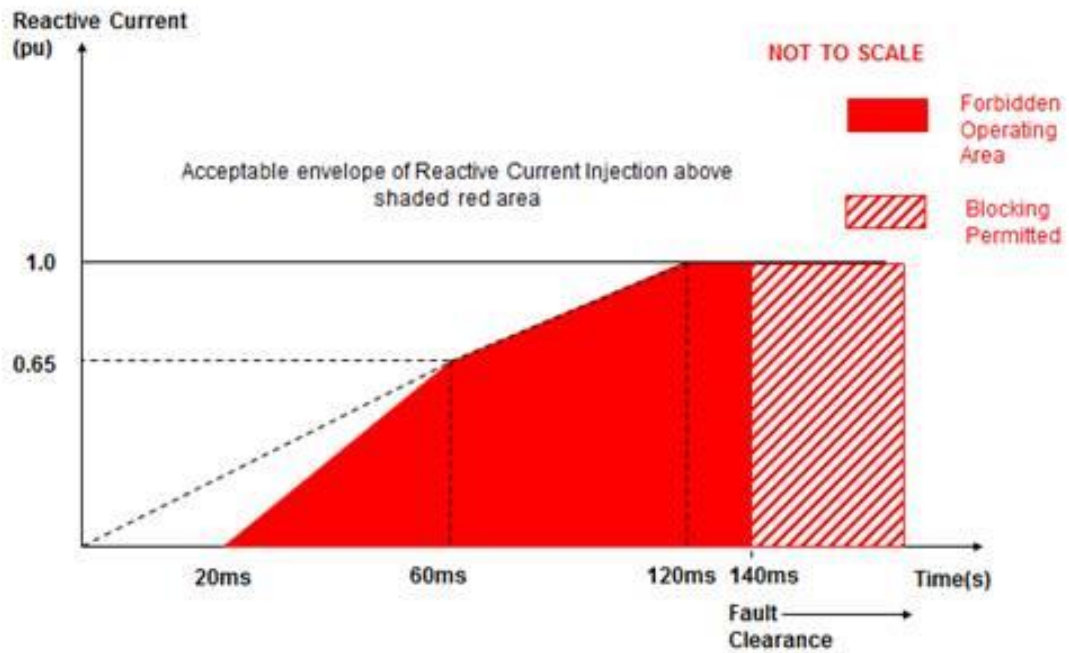

Figure ECC.16.3.16(c)

ECC.6.3.16.1.5 The injected reactive current (I_R) shall be above the shaded area shown in Figure ECC.6.3.16(b) and Figure ECC.6.3.16(c) with priority being given to reactive current injection with any residual capability being supplied as active current. Under any faulted condition, where the voltage falls outside the limits specified in ECC.6.1.4, there would be no requirement for each **Power Park Module** or constituent **Power Park Unit** or **HVDC Equipment** to exceed its transient or steady state rating of 1.0pu as defined in ECC.6.3.16.1.7.

ECC.6.3.16.1.6 For any planned or switching events (as outlined in ECC.6.1.7 of the Grid Code) or unplanned events which results in temporary power frequency over voltages (TOV's), each **Type B, Type C and Type D Power Generating Module** or each **Power Park Unit** within a **Type B, Type C or Type D Power Park Module** or **HVDC Equipment** will be required to satisfy the transient overvoltage limits specified in the **Bilateral Agreement**.

ECC.6.3.16.1.7 For the purposes of this requirement, the maximum rated current is taken to be the maximum current each **Power Park Module** (or the sum of the constituent **Power Park Units** which are connected to the **System** at the **Grid Entry Point** or **User System Entry Point**) or **HVDC Converter** is capable of supplying. In the case of a **Power Park Module** this would be the maximum rated current at the **Grid Entry Point** (or **User System Entry Point** if **Embedded**) when the **Power Park Module** is operating at rated **Active Power** and rated **Reactive Power** (as required under ECC.6.3.2) whilst operating over the nominal voltage range as required under ECC.6.1.4 at the **Grid Entry Point** (or **User System Entry Point** if **Embedded**). In the case of a **Power Park Unit** forming part of a **Type B, Type C and Type D Power Park Module**, the maximum rated current expected would be the maximum current supplied from each constituent **Power Park Unit** when the **Power Park Module** is operating at rated **Active Power** and rated **Reactive Power** over the nominal voltage operating range as defined in ECC.6.1.4 less the contribution from the reactive compensation equipment.

For example, in the case of a 100MW **Power Park Module** (consisting of 50 x 2MW Power Park Units and +10MVA reactive compensation equipment) the **Rated Active Power** at the **Grid Entry Point** (or **User System Entry Point** if **Embedded**) would be taken as 100MW and the rated **Reactive Power** at the **Grid Entry Point** or (**User System Entry Point** if **Embedded**) would be taken as 32.8MVAr (ie **Rated MW** output operating at 0.95 **Power Factor** lead or 0.95 **Power Factor** lag as required under ECC.6.3.2.4). In this example, the maximum rating of each constituent **Power Park Unit** is obtained when the **Power Park Module** is operating at 100MW, and +32.8MVAr less 10MVAr equal to 22.8MVAr or - 32.8MVAr (less the reactive compensation equipment component of 10MVAr (ie - 22.8MVAr) when operating within the normal voltage operating range as defined under ECC.6.1.4 (allowing for any reactive compensation equipment or losses in the **Power Park Module** array network).

For the avoidance of doubt, the total current of 1.0pu would be assumed to be on the MVA rating of the **Power Park Module** or **HVDC Equipment** (less losses). Under all normal and abnormal conditions, the steady state or transient rating of the **Power Park Module** (or any constituent element including the **Power Park Units**) or **HVDC Equipment**, would not be required to exceed the locus shown in Figure 16.3.16(d).

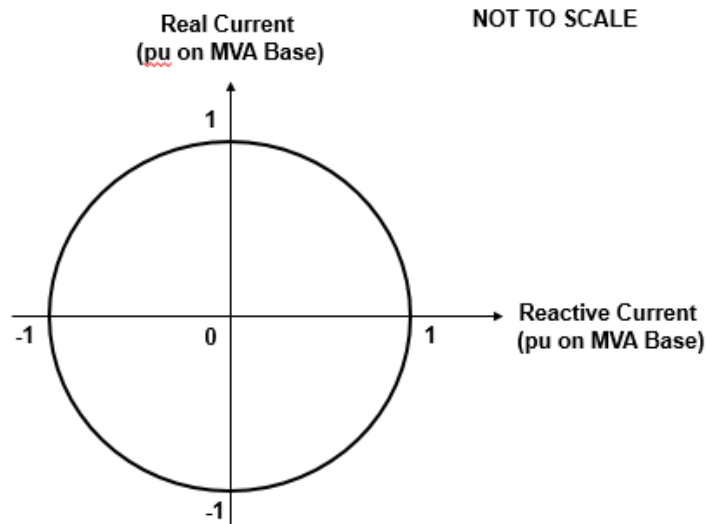

Figure ECC.16.3.16(d)

ECC.6.3.16.1.7

Each **Type B, Type C and Type D Power Park Module or HVDC Equipment** shall be designed to ensure a smooth transition between voltage control mode and fault ride through mode in order to prevent the risk of instability which could arise in the transition between the steady state voltage operating range as defined under ECC.6.1.4 and abnormal conditions where the retained voltage falls below 90% of nominal voltage. Such a requirement is necessary to ensure adequate performance between the pre-fault operating condition of the **Power Park Module or HVDC Equipment** and its subsequent behaviour under faulted conditions. **EU Generators and HVDC System Owners** are required to both advise and agree with **The Company** the control strategy employed to mitigate the risk of such instability.

ECC.6.3.16.1.8

Each **Type B, Type C and Type D Power Park Module or HVDC Equipment** shall be designed to reduce the risk of transient over voltage levels arising following clearance of the fault and in order to mitigate the risk of any form of instability which could result. **EU Generators or HVDC System Owners** shall be permitted to block or employ other means where the anticipated transient overvoltage would otherwise exceed the maximum permitted values specified in ECC.6.1.7. Figure ECC.16.3.16(b) and Figure ECC.16.3.16(c) shows the impact of variations in fault clearance time. For main protection operating times this would not exceed 140ms. The requirements for the maximum transient overvoltage withstand capability and associated time duration, shall be agreed between the **EU Code User** and **The Company** as part of the **Bilateral Agreement**. Where the **EU Code User** is able to demonstrate to **The Company** that blocking or other control strategies are required in order to prevent the risk of transient over voltage excursions as specified in ECC.6.3.16.1.5, **EU Generators and HVDC System Owners** are required to both advise and agree with **The Company** the control strategy, which must also include the approach taken to de-blocking

- ECC.6.3.16.1.9 In addition to the requirements of ECC.6.3.15, **Generators** in respect of **Type B, Type C** and **Type D Power Park Modules** or each **Power Park Unit** within a **Type B, Type C** and **Type D Power Park Module** or **DC Connected Power Park Modules** and **HVDC System Owners** in respect of **HVDC Systems** are required to confirm to **The Company**, their repeated ability to supply **Fast Fault Current** to the **System** each time the voltage at the **Grid Entry Point** or **User System Entry Point** falls outside the limits specified in ECC.6.1.4. **EU Generators** and **HVDC Equipment Owners** should inform **The Company** of the maximum number of repeated operations that can be performed under such conditions and any limiting factors to repeated operation such as protection or thermal rating.
- ECC.6.3.16.1.10 To permit additional flexibility for example from **Power Park Modules** made up of full converter machines, DFIG machines, induction generators or **HVDC Systems** or **Remote End HVDC Converters**, **The Company** will permit transient or marginal deviations below the shaded area shown in Figures ECC.16.3.16(b) or ECC.16.3.16(c) provided the injected reactive current supplied exceeds the area bound in Figure ECC.6.3.16(b) or ECC.6.3.16(c). Such agreement would be confirmed and agreed between **The Company** and **Generator**.
- ECC.6.3.16.1.11 In the case of a **Power Park Module** or **DC Connected Power Park Module**, where it is not practical to demonstrate the compliance requirements of ECC.6.3.16.1.1 to ECC.6.3.16.1.6 at the **Grid Entry Point** or **User System Entry Point**, **The Company** will accept compliance of the above requirements at the **Power Park Unit** terminals.
- ECC.6.3.16.1.12 For the avoidance of doubt, **Generators** in respect of **Type C** and **Type D Power Park Modules** and **OTSDUW Plant and Apparatus** are also required to satisfy the requirements of ECC.6.3.15.9.2.1(b) which specifies the requirements for fault ride through for voltage dips in excess of 140ms.
- ECC.6.3.16.1.13 In the case of an unbalanced fault, each **Type B, Type C** and **Type D Power Park Module** or each **Power Park Unit** within a **Type B, Type C** and **Type D Power Park Module** or **HVDC Equipment** shall be required to inject reactive current (I_R) which shall as a minimum increase with the fall in the retained unbalanced voltage up to its maximum reactive current without exceeding the transient rating of the **Power Park Module** (or constituent element thereof) or **HVDC Equipment**.
- ECC.6.3.16.1.14 In the case of a unbalanced fault, the **Generator** or **HVDC System Owner** shall confirm to **The Company** their ability to prevent transient overvoltages arising on the remaining healthy phases and the control strategy employed.
- ECC.6.3.17 SUBSYNCHRONOUS TORSIONAL INTERACTION DAMPING CAPABILITY, POWER OSCILLATION DAMPING CAPABILITY AND CONTROL FACILITIES FOR HVDC SYSTEMS
- ECC.6.3.17.1 Subsynchronous Torsional Interaction Damping Capability
- ECC.6.3.17.1.1 **HVDC System Owners**, or **Generators** in respect of **OTSDUW DC Converters** or **Network Operators** in the case of an **Embedded HVDC Systems** not subject to a **Bilateral Agreement** must ensure that any of their **Onshore HVDC Systems** or **OTSDUW DC Converters** will not cause a sub-synchronous resonance problem on the **Total System**. Each **HVDC System** or **OTSDUW DC Converter** is required to be provided with sub-synchronous resonance damping control facilities. **HVDC System Owners** and **EU Generators** in respect of **OTSDUW DC Converters** should also be aware of the requirements in ECC.6.1.9 and ECC.6.1.10.
- ECC.6.3.17.1.2 Where specified in the **Bilateral Agreement**, each **OTSDUW DC Converter** is required to be provided with power oscillation damping or any other identified additional control facilities.

- ECC.6.3.17.1.3 Each **HVDC System** shall be capable of contributing to the damping of power oscillations on the **National Electricity Transmission System**. The control system of the **HVDC System** shall not reduce the damping of power oscillations. **The Company** in coordination with the **Relevant Transmission Licensee** (as applicable) shall specify a frequency range of oscillations that the control scheme shall positively damp and the **System** conditions when this occurs, at least accounting for any dynamic stability assessment studies undertaken by the **Relevant Transmission Licensee** or **The Company** (as applicable) to identify the stability limits and potential stability problems on the **National Electricity Transmission System**. The selection of the control parameter settings shall be agreed between **The Company** in coordination with the **Relevant Transmission Licensee** and the **HVDC System Owner**.
- ECC.6.3.17.1.4 **The Company** shall specify the necessary extent of SSTI studies and provide input parameters, to the extent available, related to the equipment and relevant system conditions on the **National Electricity Transmission System**. The SSTI studies shall be provided by the **HVDC System Owner**. The studies shall identify the conditions, if any, where SSTI exists and propose any necessary mitigation procedure. The responsibility for undertaking the studies in accordance with these requirements lies with the **Relevant Transmission Licensee** in co-ordination with **The Company**. All parties shall be informed of the results of the studies.
- ECC.6.3.17.1.5 All parties identified by **The Company** as relevant to each **Grid Entry Point** or **User System Entry Point** (if **Embedded**), including the **Relevant Transmission Licensee**, shall contribute to the studies and shall provide all relevant data and models as reasonably required to meet the purposes of the studies. **The Company** shall collect this data and, where applicable, pass it on to the party responsible for the studies in accordance with **Retained EU Law** (Article 10 of Commission Regulation (EU) 2016/1447). Specific information relating to the interface schedules, input/output requirements, timing and submission of any studies or data would be agreed between the **User** and **The Company** and specified (where applicable) in the **Bilateral Agreement**.
- ECC.6.3.17.1.6 **The Company** in coordination with the **Relevant Transmission Licensee** shall assess the result of the SSTI studies. If necessary for the assessment, **The Company** in coordination with the **Relevant Transmission Licensee** may request that the **HVDC System Owner** perform further SSTI studies in line with this same scope and extent.
- ECC.6.3.17.1.7 **The Company** in coordination with the **Relevant Transmission Licensee** may review or replicate the study. The **HVDC System Owner** shall provide **The Company** with all relevant data and models that allow such studies to be performed. Submission of this data to **Relevant Transmission Licensee's** shall be in accordance with the requirements of **Retained EU Law** (Article 10 of Commission Regulation (EU) 2016/1447).
- ECC.6.3.17.1.8 Any necessary mitigating actions identified by the studies carried out in accordance with paragraphs ECC.6.3.17.1.4 or ECC.6.3.17.1.6, and reviewed by **The Company** in coordination with the **Relevant Transmission Licensees**, shall be undertaken by the **HVDC System Owner** as part of the connection of the new **HVDC Converter Station**.
- ECC.6.3.17.1.9 As part of the studies and data flow in respect of ECC.6.3.17.1 – ECC.6.3.17.8 the following data exchange would take place with the time scales being pursuant to the terms of the **Bilateral Agreement**.

Information supplied by **The Company** and **Relevant Transmission Licensees**

Studies provided by the **User**

User review

The Company review

Changes to studies and agreed updates between **The Company**, the **Relevant Transmission Licensee** and **User**

Final review

ECC.6.3.17.2 Interaction between **HVDC Systems** or other **User's Plant and Apparatus**

ECC.6.3.17.2.1 Notwithstanding the requirements of ECC6.1.9 and ECC.6.1.10, when several **HVDC Converter Stations** or other **User's Plant and Apparatus** are within close electrical proximity, **The Company** may specify that a study is required, and the scope and extent of that study, to demonstrate that no adverse interaction will occur. If adverse interaction is identified, the studies shall identify possible mitigating actions to be implemented to ensure compliance with the requirements of ECC.6.1.9

ECC.6.3.17.2.2 The studies shall be carried out by the connecting **HVDC System Owner** with the participation of all other **User's** identified by **The Company** in coordination with **Relevant Transmission Licensees** as relevant to each **Connection Point**.

ECC.6.3.17.2.3 All **User's** identified by **The Company** as relevant to the connection, and where applicable **Relevant Transmission Licensee's**, shall contribute to the studies and shall provide all relevant data and models as reasonably required to meet the purposes of the studies. **The Company** shall collect this input and, where applicable, pass it on to the party responsible for the studies in accordance with **Retained EU Law** (Article 10 of Commission Regulation (EU) 2016/1447). Specific information relating to the interface schedules, input/output requirements, timing and submission of any studies or data would be agreed between the **User** and **The Company** and specified (where applicable) in the **Bilateral Agreement**.

ECC.6.3.17.2.4 **The Company** in coordination with **Relevant Transmission Licensees** shall assess the result of the studies based on their scope and extent as specified in accordance with ECC.6.3.17.2.1. If necessary for the assessment, **The Company** in coordination with the **Relevant Transmission Licensee** may request the **HVDC System Owner** to perform further studies in line with the scope and extent specified in accordance with ECC.6.3.17.2.1.

ECC.6.3.17.2.5 **The Company** in coordination with the **Relevant Transmission Licensee** may review or replicate some or all of the studies. The **HVDC System Owner** shall provide **The Company** all relevant data and models that allow such studies to be performed.

ECC.6.3.17.2.6 The **EU Code User** and **The Company**, in coordination with the **Relevant Transmission Licensee**, shall agree any mitigating actions identified by the studies carried out following the site specific requirements and works, including any transmission reinforcement works and / or **User** works required to ensure that all sub-synchronous oscillations are sufficiently damped.

ECC.6.1.17.3 Fast Recovery from DC faults

ECC.6.1.17.3.1 **HVDC Systems**, including DC overhead lines, shall be capable of fast recovery from transient faults within the **HVDC System**. Details of this capability shall be subject to the **Bilateral Agreement** and the protection requirements specified in ECC.6.2.2 .

ECC.6.1.17.4 Maximum loss of Active Power

ECC.6.1.14.4.1 An **HVDC System** shall be configured in such a way that its loss of **Active Power** injection in the **GB Synchronous Area** shall be in accordance with the requirements of the **SQSS**.

ECC.6.3.18 SYSTEM TO GENERATOR OPERATIONAL INTERTRIPPING SCHEMES

ECC.6.3.18.1 **The Company** may require that a **System to Generator Operational Intertripping Scheme** be installed as part of a condition of the connection of the **EU Generator**. Scheme specific details shall be included in the relevant **Bilateral Agreement** and shall, include the following information:

- (1) the relevant category(ies) of the scheme (referred to as **Category 1 Intertripping Scheme, Category 2 Intertripping Scheme, Category 3 Intertripping Scheme** and **Category 4 Intertripping Scheme**);
- (2) the **Power Generating Module** to be either permanently armed or that can be instructed to be armed in accordance with BC2.8;
- (3) the time within which the **Power Generating Module** circuit breaker(s) are to be automatically tripped;

- (4) the location to which the trip signal will be provided by **The Company**. Such location will be provided by **The Company** prior to the commissioning of the **Power Generating Module**.

Where applicable, the **Bilateral Agreement** shall include the conditions on the **National Electricity Transmission System** during which **The Company** may instruct the **System to Generator Operational Intertripping Scheme** to be armed and the conditions that would initiate a trip signal.

ECC.6.3.18.2 The time within which the **Power Generating Module(s)** circuit breaker(s) need to be automatically tripped is determined by the specific conditions local to the **EU Generator**. This 'time to trip' (defined as the time from provision of the trip signal by **The Company** to the specified location, to circuit breaker main contact opening) can typically range from 100ms to 10sec. A longer time to trip may allow the initiation of an automatic reduction in the **Power Generating Module(s)** output prior to the automatic tripping of the **Power Generating Module(s)** circuit breaker. Where applicable **The Company** may provide separate trip signals to allow for either a longer or shorter 'time to trip' to be initiated.

ECC.6.3.19 **GRID FORMING CAPABILITY**

ECC.6.3.19.1 In order for the **National Electricity Transmission System** to satisfy the stability requirements defined in the **National Electricity Transmission System Security and Quality of Supply Standards**, it is an essential requirement that an appropriate volume of **Grid Forming Plant** is available and capable of providing a **Grid Forming Capability**.

ECC.6.3.19.2 **Grid Forming Capability** is not a mandatory requirement but one which will be delivered through market arrangements, the details of which shall be published on **The Company's Website**. **Grid Forming Capability** can be implemented by any technology including **Electronic Power Converters** with a **GBGF- I** ability, rotating **Synchronous Generating Units** or a combination of the two.

ECC.6.3.19.3 As noted in ECC.6.3.19.2, **Grid Forming Capability** is not a mandatory requirement, however where a **User** (be they a **GB Code User** or **EU Code User**) or **Non-CUSC Party** wishes to offer a **Grid Forming Capability**, then they will be required to ensure their **Grid Forming Plant** meets the following requirements.

- (i) The **Grid Forming Plant** must fully comply with the applicable requirements of the Grid Code including but not limited to the **Planning Code (PC)**, **Connection Conditions (CC's)** or **European Connection Conditions (ECC's)** (as applicable), **Compliance Processes (CP's)** or **European Compliance Processes (ECP's)** (as applicable), **Operating Codes (OC's)**, **Balancing Codes (BC's)** and **Data Registration Code (DRC)**.
- (ii) Each **GBGF-I** shall comprise an **Internal Voltage Source** and reactance. For the avoidance of doubt, the reactance between the **Internal Voltage Source** and **Grid Entry Point** or **User System Entry Point (if Embedded)** within the **Grid Forming Plant** can only be made by a combination of several physical discrete reactances. This could include the reactance of the **Synchronous Generating Unit** or **Power Park Unit** or **HVDC System** or **Electricity Storage Unit** or **Dynamic Reactive Compensation Equipment** and the electrical **Plant and Apparatus** connecting the **Synchronous Generating Unit** or **Power Park Unit** or **HVDC System** or **Electricity Storage Unit** (such as a transformer) to the **Grid Entry Point** or **User System Entry Point (if Embedded)**.
- (iii) In addition to meeting the requirements of CC.6.3.15 or ECC.6.3.15, each **Grid Forming Plant** is required to remain in synchronism with the **Total System** and maintain a **Load Angle** whose value can vary between 0 and 90 degrees ($\pi/2$ radians).

- (iv) When subject to a fault or disturbance, or **System Frequency** change, each **Grid Forming Plant** shall be capable of supplying **Active ROCOF Response Power**, **Active Phase Jump Power**, **Active Damping Power**, **Active Control Based Power**, **Control Based Reactive Power**, **Voltage Jump Reactive Power** and **GBGF Fast Fault Current Injection**.
- (v) Each **GBGF-I** shall be capable of:-
- Providing a symmetrical ability for importing and exporting **Active ROCOF Response Power**, **Active Phase Jump Power**, **Active Damping Power** and **Active Control Based Power** under both rising and falling **System Frequency** conditions. Such requirements will apply over the full **System Frequency** range as detailed in CC.6.1.2 and CC.6.1.3 or ECC.6.1.2 (as applicable). In satisfying these requirements, **User's** and **Non-CUSC Parties** should be aware of (but not limited to) the exclusions in CC.6.3.3, CC.6.3.7 and BC3.7.2.1 (as applicable for **GB Code User's**) or ECC.6.1.2, ECC.6.3.3, ECC.6.3.7 and BC3.7.2.1(b)(i) (as applicable for **EU Code User's** and **Non-CUSC Parties**) during **System Frequencies** between 47Hz – 52Hz, excluding CC.6.1.3 or ECC.6.1.2.1,2 for a **Grid Forming Plant** with time limited output ratings. For the avoidance of doubt, an asymmetrical response is permissible as agreed with **The Company** when required to protect **User's** and **Non-CUSC Parties Plant** and **Apparatus** or asymmetry in energy availability.
 - Operating as a voltage source behind a real reactance.
 - being designed so as not to cause any undue interactions which could cause damage to the **Total System** or other **User's Plant** and **Apparatus**.
 - include an **Active Control Based Power** part of the control system that can respond to changes in the **Grid Forming Plant** or external signals from the **Total System** available at the **Grid Entry Point** or **User System Entry Point** but with a bandwidth below 5 Hz to avoid AC **System** resonance problems.
 - meeting the requirements of ECC.6.3.13 irrespective of being owned or operated by a **GB Code User**, **EU Code User** or **Non-CUSC Party**.
 - GBGF-I** with an importing capability mode of operation such as **DC Converters**, **HVDC Systems** and **Electricity Storage Modules** are required to have a predefined frequency response operating characteristic over the full import and export range which is contained within the envelope defined by the red and blue lines shown in Figure ECC.6.3.19.3. This characteristic shall be submitted to **The Company**. For the avoidance of doubt, **Grid Forming Plants** which are only capable of exporting **Active Power** to the **Total System** are only required to operate over the exporting power region

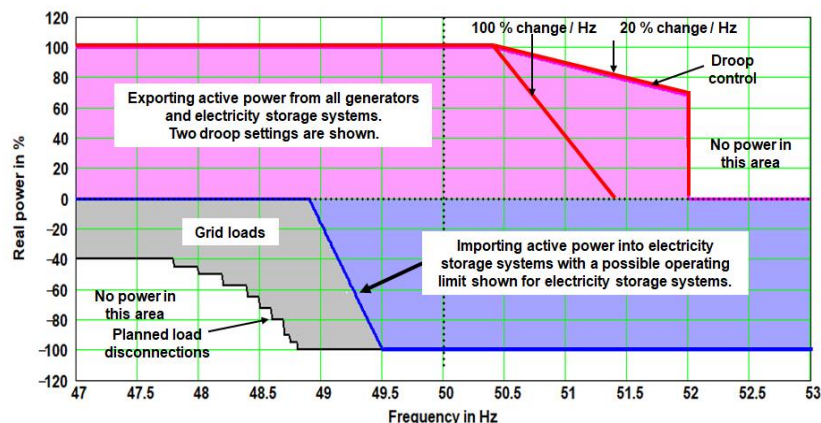

Figure ECC.6.3.19.3

- (vi) Each **User** or **Non-CUSC Party** shall design their **GBGF-I** system with an equivalent **Damping Factor** of between 0.2 and 5.0. It is down to the **User** or **Non-CUSC Party** to determine the **Damping Factor**, whose value shall be agreed with **The Company**. It is typical for the **Damping Factor** to be less than 1.0, though this will be dependent upon the parameters of the **Grid Forming Plant** and the equivalent **System** impedance at the **Grid Entry Point** or **User System Entry Point**.

The output of the **Grid Forming Plant** shall be designed such that following a disturbance on the **System**, the **Active Power** output and **Reactive Power** output shall be adequately damped. The damping shall be judged to be adequate if the corresponding **Active Power** response to a disturbance decays with a response that is in line with the response of second order system that has the same equivalent **Damping Factor**.

- (vii) Each **GBGF-I** shall be designed so as not to interact and affect the operation, performance, safety or capability of other **User's Plant** and **Apparatus** connected to the **Total System**. To achieve this requirement, each **User** and **Non-CUSC Party** shall be required to submit the data required in PC.A.5.8

ECC.6.3.19.4 In addition to the requirements of ECC.6.3.19.1 – ECC.6.3.19.3 each **Grid Forming Plant** shall also be capable of: -

- (i) satisfying the requirements of ECC.6.3.19.5.
- (ii) operating at a minimum short circuit level of zero MVA at the **Grid Entry Point** or **User System Entry Point**.
- (iii) providing any additional quality of supply requirements, including but not limited to reductions in the permitted frequency of Temporary Power **System** Over-voltage events (TOV's) and **System Frequency** bandwidth limitations, as agreed with **The Company**. Such requirements will be pursuant to the terms of the **Bilateral Agreement**. For the avoidance of doubt, this requirement is in addition the minimum quality of supply requirements detailed in CC.6.1.5, CC.6.1.6 and CC.6.1.7 (as applicable) or ECC.6.1.5, ECC.6.1.6 and ECC.6.1.7 (as applicable),

ECC.6.3.19.5 **GBGF Fast Fault Current Injection**

ECC.6.3.19.5.1 For any balanced fault which results in the positive phase sequence voltage falling below the voltage levels specified in CC.6.1.4 or ECC.6.1.4 (as applicable) at the **Grid Entry Point** or **User System Entry Point** (if **Embedded**), a **Grid Forming Plant** shall, as a minimum be required to inject a reactive current of at least their **Peak Current Rating** when the voltage at the **Grid Entry Point** or **User System Entry Point** drops to zero. For intermediate retained voltages at the **Grid Entry Point** or **User System Entry Point**, the injected reactive current shall be on or above a line drawn from the bottom left hand corner of the normal voltage control operating zone (shown in the rectangular green shaded area of Figure ECC.6.3.19.5(a)) and the specified **Peak Current Rating** at a voltage of zero at the **Grid Entry Point** or **User System Entry Point** as shown in Figure ECC.16.3.19.5(a). Typical examples of limit lines are shown in Figure ECC.16.3.19.5(a) for a **Peak Current Rating** of 1.0pu where the injected reactive current must be on or above the black line and a **Peak Current Rating** of 1.5pu where injected reactive current must be on or above the red line.

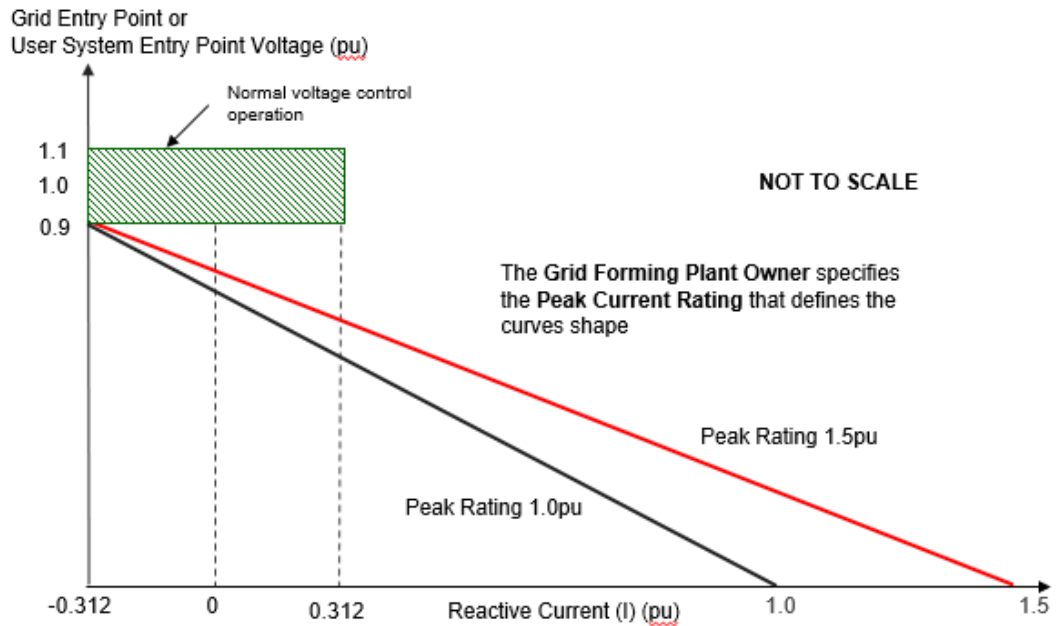

Figure ECC.6.3.19.5(a)

ECC.6.3.19.5.2 Figure ECC.6.3.19.5(a) defines the reactive current to be supplied under a faulted condition which shall be dependent upon the pre-fault operating condition and the retained voltage at the **Grid Entry Point** or **User System Entry Point** voltage. For the avoidance of doubt, each **Grid Forming Plant** (and any constituent element thereof), shall be required to inject a reactive current which shall be not less than its pre-fault reactive current and which shall as a minimum, increase each time the voltage at the **Grid Entry Point** or **User System Entry Point** (if **Embedded**) falls below 0.9pu whilst ensuring the overall rating of the **Grid Forming Plant** (or constituent element thereof) shall not be exceeded.

ECC.6.3.19.5.3 In addition to the requirements of ECC.6.3.19.5.1 and ECC.6.3.19.5.2, each **Grid Forming Plant** shall be required to inject reactive current above the shaded area shown in Figure ECC.6.3.19.5(b) when the retained voltage at the **Grid Entry Point** or **User System Entry Point** falls to 0pu. Where the retained voltage at the **Grid Entry Point** or **User System Entry Point** is below 0.9pu but above 0pu (for example when significant active current is drawn by loads and/or resistive components arising from both local and remote faults or disturbances from other **Plant** and **Apparatus** connected to the **Total System**) the injected reactive current component shall be in accordance with Figure ECC.6.3.19.5(a).

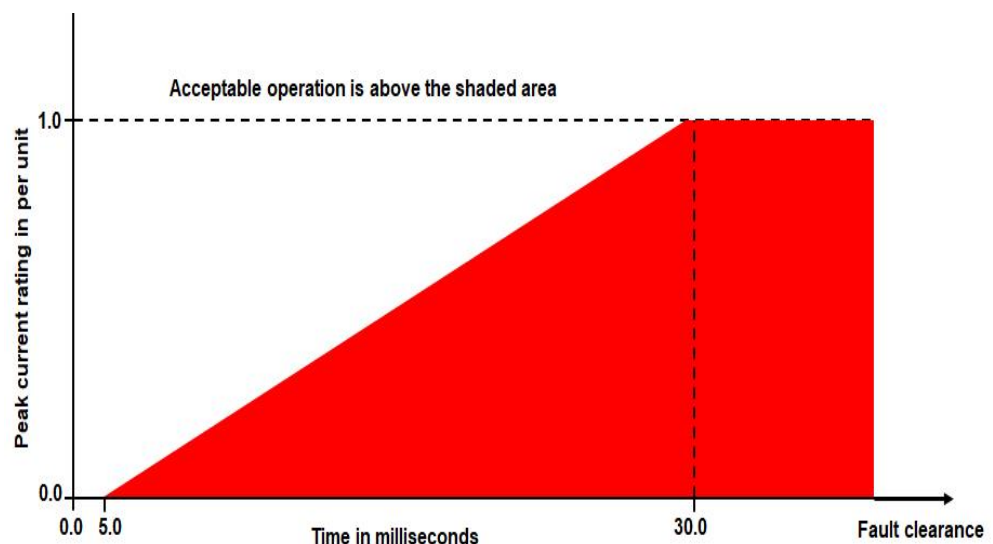

Figure ECC.6.3.19.5(b)

- ECC.6.3.19.5.4 The injected current shall be above the shaded area shown in Figure ECC.6.3.19.5(b) for the duration of the fault clearance time which for faults on the **Transmission System** cleared in **Main Protection** operating times shall be up to 140ms. Under any faulted condition, where the voltage falls outside the limits specified in CC.6.1.4 or ECC.6.1.4 (as applicable), there will be no requirement for each **Grid Forming Plant** or constituent part to exceed its transient or steady state rating as defined in Table PC.A.5.8.2.
- ECC.6.3.19.5.5 For any planned or switching events (as outlined in CC.6.1.7 or ECC.6.1.7 of the Grid Code) or unplanned events which results in Temporary Power **System** Over Voltages (TOV's), each **Grid Forming Plant** will be required to satisfy the transient overvoltage limits specified in the **Bilateral Agreement**.
- ECC.6.3.19.5.6 For the purposes of this requirement, the maximum rated current will be the **Peak Current Rating** declared by the **Grid Forming Plant Owner** in accordance with Table PC.A.5.8.2.
- ECC.6.3.19.5.7 Each **Grid Forming Plant** shall be designed to ensure a smooth transition between voltage control mode and **Fault Ride Through** mode in order to prevent the risk of instability which could arise in the transition between the steady state voltage operating range as defined under CC.6.1.4 or ECC.6.1.4 (as applicable) and abnormal conditions where the retained voltage falls below 90% of nominal voltage. Such a requirement is necessary to ensure adequate performance between the pre-fault operating condition of the **Grid Forming Plant** and its subsequent behaviour under faulted conditions. **Grid Forming Plant Owners** are required to both advise and agree with **The Company** the control strategy employed to mitigate the risk of such instability.
- ECC.6.3.19.5.8. Each **Grid Forming Plant** shall be designed to reduce the risk of transient over voltage levels arising following clearance of the fault and in order to mitigate the risk of any form of instability which could result. The requirements for the maximum transient overvoltage withstand capability and associated time duration, shall be agreed between the **User** or **Non-CUSC Party** and **The Company** as part of the **Bilateral Agreement**.
- ECC.6.3.19.5.9 In addition to the requirements of CC.6.3.15 or ECC.6.3.15, each **Grid Forming Plant Owner** is required to confirm to **The Company**, their repeated ability to supply **GBGF Fast Fault Current Injection** to the **System** each time the voltage at the **Grid Entry Point** or **User System Entry Point** falls outside the limits specified in CC.6.1.4 or ECC.6.1.4 (as applicable). **Grid Forming Plant Owners** should inform **The Company** of the maximum number of repeated operations that can be performed under such conditions and any limiting factors to repeated operation such as protection or thermal rating.
- ECC.6.3.19.5.10 In the case of a **Power Park Module** or **DC Connected Power Park Module**, where it is not practical to demonstrate the compliance requirements of ECC.6.3.19.5.1 to ECC.6.3.19.5.5 at the **Grid Entry Point** or **User System Entry Point**, **The Company** will accept compliance of the above requirements at the **Power Park Unit** terminals.
- ECC.6.3.19.5.11 In the case of an unbalanced fault, each **Grid Forming Plant**, shall be required to inject current which shall as a minimum increase with the fall in the unbalanced voltage without exceeding the transient **Peak Current Rating** of the **Grid Forming Plant** (or constituent element thereof).
- ECC.6.3.19.5.12 In the case of an unbalanced fault, the **User** or **Non-CUSC Party** shall confirm to **The Company** their ability to prevent transient overvoltages arising on the remaining healthy phases and the control strategy employed.
- ECC.6.4 General Network Operator And Non-Embedded Customer Requirements
- ECC.6.4.1 This part of the **Grid Code** describes the technical and design criteria and performance requirements for **Network Operators** and **Non-Embedded Customers**.

Neutral Earthing

ECC.6.4.2 At nominal **System** voltages of 132kV and above the higher voltage windings of three phase transformers and transformer banks connected to the **National Electricity Transmission System** must be star connected with the star point suitable for connection to earth. The earthing and lower voltage winding arrangement shall be such as to ensure that the **Earth Fault Factor** requirement of paragraph ECC.6.2.1.1 (b) will be met on the **National Electricity Transmission System** at nominal **System** voltages of 132kV and above.

Frequency Sensitive Relays

ECC.6.4.3 As explained under **OC6**, each **Network Operator** and **Non Embedded Customer**, will make arrangements that will facilitate automatic low **Frequency Disconnection of Demand** (based on **Annual ACS Conditions**). ECC.A.5.5. of Appendix E5 includes specifications of the local percentage **Demand** that shall be disconnected at specific frequencies. The manner in which **Demand** subject to low **Frequency** disconnection will be split into discrete MW blocks is specified in OC6.6. Technical requirements relating to **Low Frequency Relays** are also listed in Appendix E5.

Operational Metering

ECC.6.4.4 Where **The Company** can reasonably demonstrate that an **Embedded Medium Power Station** or **Embedded HVDC System** has a significant effect on the **National Electricity Transmission System**, it may require the **Network Operator** within whose **System** the **Embedded Medium Power Station** or **Embedded HVDC System** is situated to ensure that the operational metering equipment described in ECC.6.5.6 is installed such that **The Company** can receive the data referred to in ECC.6.5.6. In the case of an **Embedded Medium Power Station** subject to, or proposed to be subject to a **Bilateral Agreement**, **The Company** shall notify such **Network Operator** of the details of such installation in writing within 3 months of being notified of the application to connect under **CUSC** and in the case of an **Embedded Medium Power Station** not subject to, or not proposed to be subject to a **Bilateral Agreement** in writing as a **Site Specific Requirement** in accordance with the timescales in CUSC 6.5.5. In either case the **Network Operator** shall ensure that the data referred to in ECC.6.5.6 is provided to **The Company**.

ECC.6.4.5 Reactive Power Requirements at each EU Grid Supply Point

ECC.6.4.5.1 At each **EU Grid Supply Point**, **Non-Embedded Customers** and **Network Operators** who are **EU Code Users** shall ensure their **Systems** are capable of steady state operation within the **Reactive Power** limits as specified in ECC.6.4.5.1(a) and ECC.6.4.5.1(b). Where **The Company** requires a **Reactive Power** range which is broader than the limits defined in ECC.6.4.5.1(a) and ECC.6.4.5.1(b), this will be agreed as a reasonable requirement through joint assessment between the relevant **EU Code User** and **The Company** and justified in accordance with the requirements of ECC.6.4.5.1(c), (d), (e) and (f). For **Non-Embedded Customers** who are **EU Code Users**, the **Reactive Power** range at each **EU Grid Supply Point**, under both importing and exporting conditions, shall not exceed 48% of the larger of the **Maximum Import Capability** or **Maximum Export Capability** (0.9 **Power Factor** import or export of **Active Power**), except in situations where either technical or financial system benefits are demonstrated for **Non-Embedded Customers** and accepted by **The Company** in coordination with the **Relevant Transmission Licensee**.

(a) For **Network Operators** who are **EU Code Users** at each **EU Grid Supply Point**, the **Reactive Power** range shall not exceed:

- (i) 48 percent (i.e. 0.9 **Power Factor**) of the larger of the **Maximum Import Capability** or **Maximum Export Capability** during **Reactive Power** import (consumption); and
- (ii) 48 percent (i.e. 0.9 **Power Factor**) of the larger of the **Maximum Import Capability** or **Maximum Export Capability** during **Reactive Power** export (production);

Except in situations where either technical or financial system benefits are proved by **The Company** in coordination with the **Relevant Transmission Licensee** and the relevant **Network Operator** through joint analysis.

- (b) **The Company** in co-ordination with the **Relevant Transmission Licensee** shall agree with the **Network Operator** on the scope of the analysis, which shall determine the optimal solution for **Reactive Power** exchange between their **Systems** at each **EU Grid Supply Point**, taking adequately into consideration the specific **System** characteristics, variable structure of power exchange, bidirectional flows and the **Reactive Power** capabilities of the **Network Operator's System**. Any proposed solutions shall take the above issues into account and shall be agreed as a reasonable requirement through joint assessment between the relevant **Network Operator** or **Non-Embedded Customer** and **The Company** in coordination with the **Relevant Transmission Licensee**. In the event of a shared site between a **GB Code User** and **EU Code User**, the requirements would generally be allocated to each **User** on the basis of their **Demand** in the case of a **Network Operator** who is a **GB Code User** and applied on the basis of the **Maximum Import Capability** or **Maximum Export Capability** as specified in ECC.6.4.5.1 in the case of a **Network Operator** who is an **EU Code User**.
- (c) **The Company** in coordination with the **Relevant Transmission Licensee** may specify the **Reactive Power** capability range at the **EU Grid Supply Point** in another form other than **Power Factor**.
- (d) Notwithstanding the ability of **Network Operators** or **Non Embedded Customers** to apply for a derogation from ECC.6.4.5.1 (e), where an **EU Grid Supply Point** is shared between a **Power Generating Module** and a **Non-Embedded Customers System**, the **Reactive Power** range would be apportioned to each **EU Code User** at their **Connection Point**.

ECC.6.4.5.2 Where agreed with the **Network Operator** who is an **EU Code User** and justified through appropriate **System** studies, **The Company** may reasonably require the **Network Operator** not to export **Reactive Power** at the **EU Grid Supply Point** (at nominal voltage) at an **Active Power** flow of less than 25 % of the **Maximum Import Capability**. Where applicable, the **Authority** may require **The Company** in coordination with the **Relevant Transmission Licensee** to justify its request through a joint analysis with the relevant **Network Operator** and demonstrate that any such requirement is reasonable. If this requirement is not justified based on the joint analysis, **The Company** in coordination with the **Relevant Transmission Licensee** and the **Network Operator** shall agree on necessary requirements according to the outcomes of a joint analysis.

ECC.6.4.5.3 Notwithstanding the requirements of ECC.6.4.5.1(b) and subject to agreement between **The Company** and the relevant **Network Operator** there may be a requirement to actively control the exchange of **Reactive Power** at the **EU Grid Supply Point** for the benefit of the **Total System**. **The Company** and the relevant **Network Operator** shall agree on a method to carry out this control, to ensure the justified level of security of supply for both parties. Any such solution including joint study work and timelines would be agreed between **The Company** and the relevant **Network Operator** as reasonable, efficient and proportionate.

ECC.6.4.5.4 In accordance with ECC.6.4.5.3, the relevant **Network Operator** may require **The Company** to consider its **Network Operator's System** for **Reactive Power** management. Any such requirement would need to be agreed between **The Company** and the relevant **Network Operator** and justified by **The Company**.

ECC.6.4.6 System Restoration

- ECC.6.4.6.1 **Distribution Restoration Zone Plans** are dependent upon **Restoration Contractors** who, have an **Anchor Restoration Contract** which requires the capability to **Start-Up** from **Shutdown** within 8 hours and to energise a part of a **Network Operator's System** (and in some cases could extend to energisation of parts of the **Transmission System**) upon instruction from a relevant **Network Operator**, without an external electrical power supply. **Distribution Restoration Zone Plans** may also be dependent upon **Top Up Restoration Contractors**. **Network Operators** shall be responsible for instructing **Restoration Contractors** in accordance with a **Distribution Restoration Zone Plan** once **The Company** has issued an instruction to the **Network Operator** to activate a **Distribution Restoration Zone** as provided for in OC9.4.7.8.1.
- ECC.6.4.6.2. Where a need for a **Distribution Restoration Zone** is agreed in accordance with OC9, the following requirements shall apply:-
- (a) Where there is a requirement for two adjacent **Distribution Restoration Zones** to be **Synchronised** as part of the wider **System Restoration** process and as catered for in the relevant **Distribution Restoration Zone Plans**, appropriate **Synchronising** facilities shall exist or shall be installed by the **Network Operator** or **Relevant Transmission Licensee** as set out in OC9.4.7.6.3(d). Such **Synchronising** facilities shall be identified as part of the development of the **Restoration Plan** as set out in OC9.4.7.6.1. Where a **Distribution Restoration Zone** extends to **Transmission Plant** and **Apparatus** as provided for in OC9.4.7.8.15, the responsibility for the provision of these facilities on **Transmission** equipment is the responsibility of the **Relevant Transmission Licensee**.
 - (b) **The Company** and the **Network Operator** and **Relevant Transmission Licensee** (where necessary) shall agree the monitoring and operational metering which shall be installed in the **Network Operator's System**, including but not limited to, operational metering signals, status indications and the topology of the **Network Operator's System** falling within the scope of the **Local Joint Restoration Plan** or **Distribution Restoration Zone Plan**, and the output and status of **Restoration Contractor's Plant** and **Apparatus**. Where appropriate, some of this information may be supplied as outputs from the **Distribution Restoration Zone Control System** within the **Distribution Restoration Zone** where one is installed. This data shall be provided to **The Company** and **Relevant Transmission Licensee** (where necessary) through appropriate data links as agreed between **The Company** and the **Network Operator**.
 - (c) **Network Operators** shall have secure, robust and power resilient communications systems between their **Control Centres** and the point at which **Restoration Contractor's Plant** and **Apparatus** is connected to the **Network Operator's System** as provided for in ECC.7.10 and ECC.7.11.

ECC.6.5 Communications Plant

ECC.6.5.1 In order to ensure control of the **National Electricity Transmission System**, telecommunications between **Users** and **The Company** must (including in respect of any **OTSDUW Plant and Apparatus** at the **OTSUA Transfer Time**), if required by **The Company**, be established in accordance with the requirements set down below.

ECC.6.5.2 Control Telephony and System Telephony

ECC.6.5.2.1 **Control Telephony** provides secure point to point telephony for routine **Control Calls**, priority **Control Calls** and emergency **Control Calls**.

ECC.6.5.2.2 **System Telephony** uses an appropriate public communications network to provide telephony for **Control Calls**, inclusive of emergency **Control Calls**. For the avoidance of doubt, **System Telephony** could include but shall not be limited to: an analogue or digital telephone line; a mobile telephone or an internet-based voice communication system, all of which would be connected to an appropriate public communications network.

ECC.6.5.2.3 Calls made and received over **Control Telephony** and **System Telephony** may be recorded and subsequently replayed for commercial and operational reasons.

- ECC.6.5.3 Not Used
- ECC.6.5.4 Obligations in respect of Control Telephony and System Telephony
- ECC.6.5.4.1 Where **The Company** requires **Control Telephony**, **Users** are required to use the **Control Telephony** to communicate with **The Company** and / or the **Transmission Licensees'** in respect of all **Connection Points** with the **National Electricity Transmission System**, all **Embedded Large Power Stations**, **Embedded HVDC Systems** and **Network Operator's Control Centres** as appropriate. **The Company** shall provide **Control Telephony** interface equipment at the **User's Control Point** or the **Network Operators Control Centre** as appropriate. Where the **EU Code User's** or **Network Operators Control Centre** telephony equipment is not capable of providing the required facilities or is otherwise incompatible with the **Transmission Control Telephony**, **The Company** shall provide a **Control Telephony** handset(s). Details of and relating to the **Control Telephony** requirements are contained in the **Bilateral Agreement** with **EU Code User's**.
- ECC.6.5.4.2 Where in **The Company's** sole opinion the installation of **Control Telephony** is not practicable at a **User's Control Point(s)**, **The Company** shall specify in the **Bilateral Agreement** whether **System Telephony** is required. Where **System Telephony** is required by **The Company**, the **User** shall ensure that **System Telephony** is installed.
- ECC.6.5.4.3 Where **System Telephony** is installed, **EU Code Users** are required to use the **System Telephony** for communication with **The Company** and the relevant **Transmission Licensees' Control Engineers** in respect of those **Control Point(s)** for which it has been installed. Details of and relating to the **System Telephony** required are contained in the **Bilateral Agreement**.
- ECC.6.5.4.4 Where **Control Telephony** or **System Telephony** is installed, routine testing of such facilities may be required by **The Company** (not normally more than once in any calendar month). The **User** and **The Company** shall use reasonable endeavours to agree a test programme and where **The Company** requests the assistance of the **User** in performing the agreed test programme the **User** shall provide such assistance. **The Company** requires the **EU Code User** to test the backup power supplies feeding its **Control Telephony** facilities at least once every 5 years.
- ECC.6.5.4.5 **Control Telephony** and **System Telephony** shall only be used for the purposes of operational voice communication between **The Company** and the relevant **User**.
- ECC.6.5.4.6 **Control Telephony** contains emergency calling functionality to be used for operational communication only under normal and emergency conditions. Functionality enables **The Company** and **Users** to utilise a priority call in the event of an emergency. **The Company** and **EU Code Users** shall only use such priority call functionality for urgent operational communications.
- ECC.6.5.5 Technical Requirements for Control Telephony and System Telephony
- ECC.6.5.5.1 Detailed information on the technical interfaces and support requirements for **Control Telephony** is provided in the **Control Telephony Electrical Standard** identified in the Annex to the **General Conditions**. Where additional information, or information in relation to **Control Telephony** applicable in Scotland, is requested by **Users**, this will be provided, where possible, by **The Company**.
- ECC.6.5.5.2 **System Telephony** shall consist of a dedicated telephone connected to an appropriate public communications network that shall be configured by the relevant **User**. **The Company** shall provide a dedicated free phone number (UK only), for the purposes of receiving incoming calls to **The Company**, which **Users** shall utilise for **System Telephony**. **System Telephony** shall only be utilised by **The Company's Control Engineer** and the **User's Responsible Engineer/Operator** for the purposes of operational communications.
- ECC.6.5.6 Operational Metering

- ECC.6.5.6.1 It is an essential requirement for **The Company** and **Network Operators** to have visibility of the real time output and status of indications of **User's Plant and Apparatus** so they can control the operation of the **System**.
- ECC.6.5.6.2 **Type B, Type C** and **Type D Power Park Modules, HVDC Equipment, Network Operators** and **Non Embedded Customers** are required to be capable of exchanging operational metering data with **The Company** and **Relevant Transmission Licensees** (as applicable) with time stamping. Time stamping would generally be to a sampling rate of 1 second or better unless otherwise specified by **The Company** in the **Bilateral Agreement**.
- ECC.6.5.6.3 **The Company** in coordination with the **Relevant Transmission Licensee** shall specify in the **Bilateral Agreement** the operational metering signals to be provided by the **EU Generator, HVDC System Owner, Network Operator** or **Non-Embedded Customer**. In the case of **Network Operators** and **Non-Embedded Customers**, detailed specifications relating to the operational metering standards at **EU Grid Supply Points** and the data required are published as **Electrical Standards** in the Annex to the **General Conditions**.
- ECC.6.5.6.4 (a) **The Company** or **The Relevant Transmission Licensee**, as applicable, shall provide system control and data acquisition (SCADA) outstation interface equipment. Each **EU Code User** shall provide such voltage, current, **Frequency, Active Power** and **Reactive Power** measurement outputs and plant status indications and alarms to the **Transmission SCADA** outstation interface equipment as required by **The Company** in accordance with the terms of the **Bilateral Agreement**. In the case of **OTSDUW**, the **User** shall provide such SCADA outstation interface equipment and voltage, current, **Frequency, Active Power** and **Reactive Power** measurement outputs and plant status indications and alarms to the SCADA outstation interface equipment as required by **The Company** in accordance with the terms of the **Bilateral Agreement**.
- (b) For the avoidance of doubt, for **Active Power** and **Reactive Power** measurements, circuit breaker and disconnect status indications from:
- (i) **CCGT Modules** from **Type B, Type C** and **Type D Power Generating Modules**, the outputs and status indications must each be provided to **The Company** on an individual **CCGT Unit** basis. In addition, where identified in the **Bilateral Agreement**, **Active Power** and **Reactive Power** measurements from **Unit Transformers** and/or **Station Transformers** must be provided.
- (ii) For **Type B, Type C** and **Type D Power Park Modules** the outputs and status indications must each be provided to **The Company** on an individual **Power Park Module** basis. In addition, where identified in the **Bilateral Agreement**, **Active Power** and **Reactive Power** measurements from station transformers must be provided.
- (iii) In respect of **OTSDUW Plant and Apparatus**, the outputs and status indications must be provided to **The Company** for each piece of electrical equipment. In addition, where identified in the **Bilateral Agreement**, **Active Power** and **Reactive Power** measurements at the **Interface Point** must be provided.
- (c) For the avoidance of doubt, the requirements of ECC.6.5.6.4(a) in the case of a **Cascade Hydro Scheme** will be provided for each **Generating Unit** forming part of that **Cascade Hydro Scheme**. In the case of **Embedded Generating Units** forming part of a **Cascade Hydro Scheme** the data may be provided by means other than the SCADA outstation located at the **Power Station**, such as, with the agreement of the **Network Operator** in whose system such **Embedded Generating Unit** is located, from the **Network Operator's** SCADA system to **The Company**. Details of such arrangements will be contained in the relevant **Bilateral Agreements** between **The Company** and the **Generator** and the **Network Operator**.

- (d) In the case of a **Power Park Module**, additional energy input signals (e.g. wind speed, and wind direction) may be specified in the **Bilateral Agreement**. A **Power Available** signal will also be specified in the **Bilateral Agreement**. The signals would be used to establish the potential level of energy input from the **Intermittent Power Source** for monitoring pursuant to ECC.6.6.1 and **Ancillary Services** and will, in the case of a wind farm, be used to provide **The Company** with advanced warning of excess wind speed shutdown and to determine the level of **Headroom** available from **Power Park Modules** for the purposes of calculating response and reserve. For the avoidance of doubt, the **Power Available** signal would be automatically provided to **The Company** and represent the sum of the potential output of all available and operational **Power Park Units** within the **Power Park Module**. The refresh rate of the **Power Available** signal shall be specified in the **Bilateral Agreement**. In the case of an **Electricity Storage Module**, the requirement to provide a **Power Available Signal** when the **Plant** is in both an importing and exporting mode of operation would be specified in the **Bilateral Agreement**.
- (e) In the case of an **Electricity Storage Module**, additional input signals (e.g. state of energy (MWhr, and system availability) may be specified in the **Bilateral Agreement**. A **Power Available** signal will also be specified in the **Bilateral Agreement** in accordance with the requirements of ECC.6.5.6.4(d).

ECC.6.5.6.5 In addition to the requirements of the **Balancing Codes**, each **HVDC Converter** unit of an **HVDC system** shall be equipped with an automatic controller capable of receiving instructions from **The Company**. This automatic controller shall be capable of operating the **HVDC Converter** units of the **HVDC System** in a coordinated way. **The Company** shall specify the automatic controller hierarchy per **HVDC Converter** unit.

ECC.6.5.6.6 The automatic controller of the **HVDC System** referred to in paragraph ECC.6.5.6.5 shall be capable of sending the following signal types to **The Company** (where applicable) :

(a) operational metering signals, providing at least the following:

- (i) start-up signals;
- (ii) AC and DC voltage measurements;
- (iii) AC and DC current measurements;
- (iv) **Active** and **Reactive Power** measurements on the AC side;
- (v) DC power measurements;
- (vi) **HVDC Converter** unit level operation in a multi-pole type **HVDC Converter**;
- (vii) elements and topology status; and
- (viii) **Frequency Sensitive Mode, Limited Frequency Sensitive Mode Overfrequency** and **Limited Frequency Sensitive Mode Underfrequency Active Power** ranges (where applicable).

(b) alarm signals, providing at least the following:

- (i) emergency blocking;
- (ii) ramp blocking;
- (iii) fast **Active Power** reversal (where applicable)

ECC.6.5.6.7 The automatic controller referred to in ECC.6.5.6.5 shall be capable of receiving the following signal types from **The Company** (where applicable) :

(a) operational metering signals, receiving at least the following:

- (i) start-up command;
- (ii) **Active Power** setpoints;
- (iii) **Frequency Sensitive Mode** settings;
- (iv) **Reactive Power**, voltage or similar setpoints;

- (v) **Reactive Power** control modes;
- (vi) power oscillation damping control; and

(b) alarm signals, receiving at least the following:

- (i) emergency blocking command;
- (ii) ramp blocking command;
- (iii) **Active Power** flow direction; and
- (iv) fast **Active Power** reversal command.

ECC.6.5.6.8 With regards to operational metering signals, the resolution and refresh rate required would be 1 second or better unless otherwise agreed with **The Company**

ECC.6.5.6.9 In addition to the above requirements, **Restoration Contractors** shall be capable of providing the operational metering requirements specified in the **Anchor Restoration Contract** or **Top Up Restoration Contract** during **System Restoration**. In particular for renewable generation, the volume of primary energy such as wind speed and in the case of storage, storage capacity shall be provided.

Instructor Facilities

ECC.6.5.7 The **EU Code User** shall accommodate **Instructor Facilities** provided by **The Company** for the receipt of operational messages relating to **System** conditions.

Electronic Data Communication Facilities

ECC.6.5.8 (a) All **BM Participants** must ensure that appropriate electronic data communication facilities are in place to permit the submission of data, as required by the **Grid Code**, to **The Company**.

(b) In addition,

(1) any **User** that wishes to participate in the **Balancing Mechanism**;

or

(2) any **BM Participant** in respect of its **BM Units** at a **Power Station** and the **BM Participant** is required to provide all **Part 1 System Ancillary Services** in accordance with ECC.8.1 (unless **The Company** has otherwise agreed)

must ensure that appropriate automatic logging devices are installed at the **Control Points** of its **BM Units** to submit data to and to receive instructions from **The Company**, as required by the **Grid Code**. For the avoidance of doubt, in the case of an **Interconnector User** the **Control Point** will be at the **Control Centre** of the appropriate **Externally Interconnected System Operator**.

(c) Detailed specifications of these required electronic facilities will be provided by **The Company** on request and they are listed as **Electrical Standards** in the Annex to the **General Conditions**.

Facsimile Machines

ECC.6.5.9 Each **User** and **The Company** shall provide a facsimile machine or machines:

- (a) in the case of **Generators**, at the **Control Point** of each **Power Station** and at its **Trading Point**;
- (b) in the case of **The Company** and **Network Operators**, at the **Control Centre(s)**; and
- (c) in the case of **Non-Embedded Customers** and **HVDC Equipment** owners at the **Control Point**.

Each **User** shall notify, prior to connection to the **System** of the **User's Plant and Apparatus**, **The Company** of its or their telephone number or numbers, and will notify **The Company** of any changes. Prior to connection to the **System** of the **User's Plant and Apparatus** **The Company** shall notify each **User** of the telephone number or numbers of its facsimile machine or machines and will notify any changes.

ECC.6.5.10 Busbar Voltage

The Relevant Transmission Licensee shall, subject as provided below, provide each **Generator** or **HVDC System Owner** at each **Grid Entry Point** where one of its **Power Stations** or **HVDC Systems** is connected with appropriate voltage signals to enable the **Generator** or **HVDC System** owner to obtain the necessary information to permit its **Power Generating Modules** (including **DC Connected Power Park Modules**) or **HVDC System** to be **Synchronised** to the **National Electricity Transmission System**. The term "**voltage signal**" shall mean in this context, a point of connection on (or wire or wires from) a relevant part of **Transmission Plant** and/or **Apparatus** at the **Grid Entry Point**, to which the **Generator** or **HVDC System Owner**, with **The Company's** agreement (not to be unreasonably withheld) in relation to the **Plant** and/or **Apparatus** to be attached, will be able to attach its **Plant** and/or **Apparatus** (normally a wire or wires) in order to obtain measurement outputs in relation to the busbar.

ECC.6.5.11 Bilingual Message Facilities

- (a) A Bilingual Message Facility is the method by which the **User's Responsible Engineer/Operator**, the **Externally Interconnected System Operator** and **The Company's Control Engineers** communicate clear and unambiguous information in two languages for the purposes of control of the **Total System** in both normal and emergency operating conditions.
- (b) A Bilingual Message Facility, where required, will provide up to two hundred pre-defined messages with up to five hundred and sixty characters each. A maximum of one minute is allowed for the transmission to, and display of, the selected message at any destination. The standard messages must be capable of being displayed at any combination of locations and can originate from any of these locations. Messages displayed in the UK will be displayed in the English language.
- (c) Detailed information on a Bilingual Message Facility and suitable equipment required for individual **User** applications will be provided by **The Company** upon request.

ECC.6.6 Monitoring

ECC.6.6.1 System Monitoring

ECC.6.6.1.1 Each **Type C** and **Type D Power Generating Module** including **DC Connected Power Park Modules** shall be equipped with a facility to provide fault recording and monitoring of dynamic system behaviour. These requirements are necessary to record conditions during **System** faults and detect poorly damped power oscillations. This facility shall record the following parameters:

- voltage,
- **Active Power**,
- **Reactive Power**, and
- **Frequency**.

ECC.6.6.1.2 Detailed specifications for fault recording and dynamic system monitoring equipment including triggering criteria and sample rates are listed as **Electrical Standards** in the **Annex** to the **General Conditions**. For Dynamic System Monitoring, the specification for the communication protocol and recorded data shall also be included in the **Electrical Standard**.

- ECC.6.6.1.3 **The Company** in coordination with the **Relevant Transmission Licensee** shall specify any requirements for **Power Quality Monitoring** in the **Bilateral Agreement**. The power quality parameters to be monitored, the communication protocols for the recorded data and the time frames for compliance shall be agreed between **The Company**, the **Relevant Transmission Licensee** and **EU Generator**.
- ECC.6.6.1.4 **HVDC Systems** shall be equipped with a facility to provide fault recording and dynamic system behaviour monitoring of the following parameters for each of its **HVDC Converter Stations**:
- (a) AC and DC voltage;
 - (b) AC and DC current;
 - (c) **Active Power**;
 - (d) **Reactive Power**; and
 - (e) **Frequency**.
- ECC.6.6.1.5 **The Company** in coordination with the **Relevant Transmission Licensee** may specify quality of supply parameters to be complied with by the **HVDC System**, provided a reasonable prior notice is given.
- ECC.6.6.1.6 The particulars of the fault recording equipment referred to in ECC.6.6.1.4, including analogue and digital channels, the settings, including triggering criteria and the sampling rates, shall be agreed between the **HVDC System Owner** and **The Company** in coordination with the **Relevant Transmission Licensee**.
- ECC.6.6.1.7 All dynamic system behaviour monitoring equipment shall include an oscillation trigger, specified by **The Company**, in coordination with the **Relevant Transmission Licensee**, with the purpose of detecting poorly damped power oscillations.
- ECC.6.6.1.8 The facilities for quality of supply and dynamic system behaviour monitoring shall include arrangements for the **HVDC System Owner** and **The Company** and/or **Relevant Transmission Licensee** to access the information electronically. The communications protocols for recorded data shall be agreed between the **HVDC System Owner**, **The Company** and the **Relevant Transmission Licensee**.
- ECC.6.6.1.9 In order to accurately monitor the performance of a **Grid Forming Plant**, each **Grid Forming Plant** shall be equipped with a facility to accurately record the following parameters at a rate of 10ms : -
- **System Frequency** using a nominated algorithm as defined by **The Company**
 - The **ROCOF** rate using a nominated algorithm as defined by **The Company** based on a 500ms rolling average
 - A technique for recording the **Grid Phase Jump Angle** by using either a nominated algorithm as defined by **The Company** or an algorithm that records the time period of each half cycle with a time resolution of 10 microseconds. For a 50Hz **System**, a 1 degree phase jump is a time period change of 55.6 microseconds.
- ECC.6.6.1.10 Detailed specifications for **Grid Forming Capability Plant** dynamic performance including triggering criteria, sample rates, the communication protocol and recorded data shall be specified by **The Company** in the **Bilateral Agreement**.
- ECC.6.6.2 Frequency Response Monitoring
- ECC.6.6.2.1 Each **Type C** and **Type D Power Generating Module** including **DC Connected Power Park Modules** shall be fitted with equipment capable of monitoring the real time **Active Power** output of a **Power Generating Module** when operating in **Frequency Sensitive Mode**.
- ECC.6.6.2.2 Detailed specifications of the **Active Power Frequency** response requirements including the communication requirements are listed as **Electrical Standards** in the **Annex** to the **General Conditions**.

- ECC.6.6.2.3 **The Company** in co-ordination with the **Relevant Transmission Licensee** shall specify additional signals to be provided by the **EU Generator** by monitoring and recording devices in order to verify the performance of the **Active Power Frequency** response provision of participating **Power Generating Modules**.
- ECC.6.6.3 Compliance Monitoring
- ECC.6.6.3.1 For all on site monitoring by **The Company** of witnessed tests pursuant to the **CP** or **OC5** or **ECP** the **User** shall provide suitable test signals as outlined in either OC5.A.1 or ECP.A.4 (as applicable).
- ECC.6.6.3.2 The signals which shall be provided by the **User** to **The Company** for onsite monitoring shall be of the following resolution, unless otherwise agreed by **The Company**:
- (i) 1 Hz for reactive range tests
 - (ii) 10 Hz for frequency control tests
 - (iii) 100 Hz for voltage control tests
 - (iv) 1 kHz for **Grid Forming Plant** signals including fast fault current measurements
 - (v) 100Hz for the other **Grid Forming Plant** tests carried out in accordance with ECC.6.6.1.9
- ECC.6.6.3.3 The **User** will provide all relevant signals for this purpose in the form of d.c. voltages within the range -10V to +10V. In exceptional circumstances some signals may be accepted as d.c. voltages within the range -60V to +60V with prior agreement between the **User** and **The Company**. All signals shall:
- (i) in the case of an **Onshore Power Generating Module** or **Onshore HVDC Converter Station**, be suitably terminated in a single accessible location at the **Generator** or **HVDC Converter Station** owner's site.
 - (ii) in the case of an **Offshore Power Generating Module** and **OTSDUW Plant and Apparatus**, be transmitted onshore without attenuation, delay or filtering which would result in the inability to fully demonstrate the objectives of the test, or identify any potential safety or plant instability issues, and be suitably terminated in a single robust location normally located at or near the onshore **Interface Point** of the **Offshore Transmission System** to which it is connected.
- ECC.6.6.3.4 All signals shall be suitably scaled across the range. The following scaling would (unless **The Company** notify the **User** otherwise) be acceptable to **The Company**:
- (a) 0MW to **Maximum Capacity** or **Interface Point Capacity** 0-8V dc
 - (b) Maximum leading **Reactive Power** to maximum lagging **Reactive Power** -8 to 8V dc
 - (c) 48 – 52Hz as -8 to 8V dc
 - (d) Nominal terminal or connection point voltage -10% to +10% as -8 to 8V dc
- ECC.6.6.3.5 The **User** shall provide to **The Company** a 230V power supply adjacent to the signal terminal location.
- ECC.7 SITE RELATED CONDITIONS
- ECC.7.1 Not used.
- ECC.7.2 Responsibilities For Safety
- ECC.7.2.1 Any **User** entering and working on its **Plant** and/or **Apparatus** (including, until the **OTSUA Transfer Time**, any **OTSUA**) on a **Transmission Site** will work to the **Safety Rules** of the **Relevant Transmission Licensee**, as advised by **The Company**.

- ECC.7.2.2 For **User Sites**, **The Company** shall procure that the **Relevant Transmission Licensee** entering and working on **Transmission Plant** and/or **Apparatus** on a **User Site** will work to the **User's Safety Rules**.
- ECC.7.2.3 A **User** may, with a minimum of six weeks notice, apply to **The Company** for permission to work according to that **Users** own **Safety Rules** when working on its **Plant** and/or **Apparatus** on a **Transmission Site** rather than those set out in ECC.7.2.1. If **The Company** is of the opinion that the **User's Safety Rules** provide for a level of safety commensurate with those set out in ECC.7.2.1, **The Company** will notify the **User**, in writing, that, with effect from the date requested by the **User**, the **User** may use its own **Safety Rules** when working on its **Plant** and/or **Apparatus** on the **Transmission Site**. For a **Transmission Site**, in forming its opinion, **The Company** will seek the opinion of the **Relevant Transmission Licensee**. Until receipt of such written approval from **The Company**, the **User** will continue to use the **Safety Rules** as set out in ECC.7.2.1.
- ECC.7.2.4 In the case of a **User Site**, **The Company** may, with a minimum of six weeks notice, apply to a **User** for permission for the **Relevant Transmission Licensee** to work according to the **Relevant Transmission Licensee's Safety Rules** when working on **Transmission Plant** and/or **Apparatus** on that **User Site**, rather than the **User's Safety Rules**. If the **User** is of the opinion that the **Relevant Transmission Licensee's Safety Rules**, provide for a level of safety commensurate with that of that **User's Safety Rules**, it will notify **The Company**, in writing, that, with effect from the date requested by **The Company**, that the **Relevant Transmission Licensee** may use its own **Safety Rules** when working on its **Transmission Plant** and/or **Apparatus** on that **User's Site**. Until receipt of such written approval from the **User**, **The Company** shall procure that the **Relevant Transmission Licensee** shall continue to use the **User's Safety Rules**.
- ECC.7.2.5 For a **Transmission Site**, if **The Company** gives its approval for the **User's Safety Rules** to apply to the **User** when working on its **Plant** and/or **Apparatus**, that does not imply that the **User's Safety Rules** will apply to entering the **Transmission Site** and access to the **User's Plant** and/or **Apparatus** on that **Transmission Site**. Bearing in mind the **Relevant Transmission Licensee's** responsibility for the whole **Transmission Site**, entry and access will always be in accordance with the **Relevant Transmission Licensee's** site access procedures. For a **User Site**, if the **User** gives its approval for **Relevant Transmission Licensee Safety Rules** to apply to the **Relevant Transmission Licensee** when working on its **Plant** and **Apparatus**, that does not imply that the **Relevant Transmission Licensee's Safety Rules** will apply to entering the **User Site**, and access to the **Transmission Plant** and **Apparatus** on that **User Site**. Bearing in mind the **User's** responsibility for the whole **User Site**, entry and access will always be in accordance with the **User's** site access procedures.
- ECC.7.2.6 For **User Sites**, **Users** shall notify **The Company** of any **Safety Rules** that apply to the **Relevant Transmission Licensee's** staff working on **User Sites**. **The Company** shall procure that the **Relevant Transmission Licensee** shall notify **Users** of any **Safety Rules** that apply to the **User's** staff working on the **Transmission Site**.
- ECC.7.2.7 Each **Site Responsibility Schedule** must have recorded on it the **Safety Rules** which apply to each item of **Plant** and/or **Apparatus**.
- ECC.7.2.8 In the case of **OTSUA** a **User Site** or **Transmission Site** shall, for the purposes of this ECC.7.2, include a site at which there is an **Interface Point** until the **OTSUA Transfer Time** when it becomes part of the **National Electricity Transmission System**.
- ECC.7.3 Site Responsibility Schedules
- ECC.7.3.1 In order to inform site operational staff and **The Company's Control Engineers** of agreed responsibilities for **Plant** and/or **Apparatus** at the operational interface, a **Site Responsibility Schedule** shall be produced for **Connection Sites** (and in the case of **OTSUA**, until the **OTSUA Transfer Time**, **Interface Sites**) for **The Company**, the **Relevant Transmission Licensee** and **Users** with whom they interface.
- ECC.7.3.2 The format, principles and basic procedure to be used in the preparation of **Site Responsibility Schedules** are set down in Appendix 1.
- ECC.7.4 Operation And Gas Zone Diagrams

Operation Diagrams

- ECC.7.4.1 An **Operation Diagram** shall be prepared for each **Connection Site** at which a **Connection Point** exists (and in the case of **OTSDUW Plant and Apparatus**, by **User's** for each **Interface Point**) using, where appropriate, the graphical symbols shown in Part 1A of Appendix 2. **Users** should also note that the provisions of **OC11** apply in certain circumstances.
- ECC.7.4.2 The **Operation Diagram** shall include all **HV Apparatus** and the connections to all external circuits and incorporate numbering, nomenclature and labelling, as set out in **OC11**. At those **Connection Sites** (or in the case of **OTSDUW Plant and Apparatus**, **Interface Points**) where gas-insulated metal enclosed switchgear and/or other gas-insulated **HV Apparatus** is installed, those items must be depicted within an area delineated by a chain dotted line which intersects gas-zone boundaries. The nomenclature used shall conform with that used on the relevant **Connection Site** and circuit (and in the case of **OTSDUW Plant and Apparatus**, **Interface Point** and circuit). The **Operation Diagram** (and the list of technical details) is intended to provide an accurate record of the layout and circuit interconnections, ratings and numbering and nomenclature of **HV Apparatus** and related **Plant**.
- ECC.7.4.3 A non-exhaustive guide to the types of **HV Apparatus** to be shown in the **Operation Diagram** is shown in Part 2 of Appendix 2, together with certain basic principles to be followed unless equivalent principles are approved by **The Company**.

Gas Zone Diagrams

- ECC.7.4.4 A **Gas Zone Diagram** shall be prepared for each **Connection Site** at which a **Connection Point** (and in the case of **OTSDUW Plant and Apparatus**, by **User's** for an **Interface Point**) exists where gas-insulated switchgear and/or other gas-insulated **HV Apparatus** is utilised. They shall use, where appropriate, the graphical symbols shown in Part 1B of Appendix 2.
- ECC.7.4.5 The nomenclature used shall conform with that used in the relevant **Connection Site** and circuit (and in the case of **OTSDUW Plant and Apparatus**, relevant **Interface Point** and circuit).
- ECC.7.4.6 The basic principles set out in Part 2 of Appendix 2 shall be followed in the preparation of **Gas Zone Diagrams** unless equivalent principles are approved by **The Company**.

Preparation of Operation and Gas Zone Diagrams for Users' Sites and Transmission Interface Sites

- ECC.7.4.7 In the case of a **User Site**, the **User** shall prepare and submit to **The Company**, an **Operation Diagram** for all **HV Apparatus** on the **User** side of the **Connection Point** (and in the case of **OTSDUW Plant and Apparatus**, on what will be the **Offshore Transmission** side of the **Connection Point** and the **Interface Point**) and **The Company** shall provide the **User** with an **Operation Diagram** for all **HV Apparatus** on the **Transmission** side of the **Connection Point** (and in the case of **OTSDUW Plant and Apparatus** on what will be the **Onshore Transmission** side of the **Interface Point**, in accordance with the timing requirements of the **Bilateral Agreement** and/or **Construction Agreement** prior to the **Completion Date** under the **Bilateral Agreement** and/or **Construction Agreement**.
- ECC.7.4.8 The **User** will then prepare, produce and distribute, using the information submitted on the **User's Operation Diagram** and **The Company's Operation Diagram**, a composite **Operation Diagram** for the complete **Connection Site** (and in the case of **OTSDUW Plant and Apparatus**, **Interface Point**), also in accordance with the timing requirements of the **Bilateral Agreement** and/or **Construction Agreement**.
- ECC.7.4.9 The provisions of ECC.7.4.7 and ECC.7.4.8 shall apply in relation to **Gas Zone Diagrams** where gas-insulated switchgear and/or other gas-insulated **HV Apparatus** is utilised.

Preparation of Operation and Gas Zone Diagrams for Transmission Sites

- ECC.7.4.10 In the case of an **Transmission Site**, the **User** shall prepare and submit to **The Company** an **Operation Diagram** for all **HV Apparatus** on the **User** side of the **Connection Point**, in accordance with the timing requirements of the **Bilateral Agreement** and/or **Construction Agreement**.
- ECC.7.4.11 **The Company** will then prepare, produce and distribute, using the information submitted on the **User's Operation Diagram**, a composite **Operation Diagram** for the complete **Connection Site**, also in accordance with the timing requirements of the **Bilateral Agreement** and/or **Construction Agreement**.
- ECC.7.4.12 The provisions of ECC.7.4.10 and ECC.7.4.11 shall apply in relation to **Gas Zone Diagrams** where gas-insulated switchgear and/or other gas-insulated **HV Apparatus** is utilised.
- ECC.7.4.13 Changes to Operation and Gas Zone Diagrams
- ECC.7.4.13.1 When **The Company** has decided that it wishes to install new **HV Apparatus** or it wishes to change the existing numbering or nomenclature of **Transmission HV Apparatus** at a **Transmission Site**, **The Company** will (unless it gives rise to a **Modification** under the **CUSC**, in which case the provisions of the **CUSC** as to the timing apply) one month prior to the installation or change, send to each such **User** a revised **Operation Diagram** of that **Transmission Site**, incorporating the new **Transmission HV Apparatus** to be installed and its numbering and nomenclature or the changes, as the case may be. **OC11** is also relevant to certain **Apparatus**.
- ECC.7.4.13.2 When a **User** has decided that it wishes to install new **HV Apparatus**, or it wishes to change the existing numbering or nomenclature of its **HV Apparatus** at its **User Site**, the **User** will (unless it gives rise to a **Modification** under the **CUSC**, in which case the provisions of the **CUSC** as to the timing apply) one month prior to the installation or change, send to **The Company** a revised **Operation Diagram** of that **User Site** incorporating the **EU Code User HV Apparatus** to be installed and its numbering and nomenclature or the changes as the case may be. **OC11** is also relevant to certain **Apparatus**.
- ECC.7.4.13.3 The provisions of ECC.7.4.13.1 and ECC.7.4.13.2 shall apply in relation to **Gas Zone Diagrams** where gas-insulated switchgear and/or other gas-insulated **HV Apparatus** is installed.

Validity

- ECC.7.4.14 (a) The composite **Operation Diagram** prepared by **The Company** or the **User**, as the case may be, will be the definitive **Operation Diagram** for all operational and planning activities associated with the **Connection Site**. If a dispute arises as to the accuracy of the composite **Operation Diagram**, a meeting shall be held at the **Connection Site**, as soon as reasonably practicable, between **The Company** and the **User**, to endeavour to resolve the matters in dispute.
- (b) The composite **Operation Diagram** prepared by **The Company** or the **User**, as the case may be, will be the definitive **Operation Diagram** for all operational and planning activities associated with the **Interface Point** until the **OTSUA Transfer Time**. If a dispute arises as to the accuracy of the composite **Operation Diagram** prior to the **OTSUA Transfer Time**, a meeting shall be held at the **Interface Point**, as soon as reasonably practicable, between **The Company** and the **User**, to endeavour to resolve the matters in dispute.
- (c) An equivalent rule shall apply for **Gas Zone Diagrams** where they exist for a **Connection Site**.
- ECC.7.4.15 In the case of **OTSUA**, a **User Site** and **Transmission Site** shall, for the purposes of this ECC.7.4, include a site at which there is an **Interface Point** until the **OTSUA Transfer Time** when it becomes part of the **National Electricity Transmission System** and references to **HV Apparatus** in this ECC.7.4 shall include references to **HV OTSUA**.

ECC.7.5 Site Common Drawings

ECC.7.5.1 **Site Common Drawings** will be prepared for each **Connection Site** (and in the case of **OTSDUW**, each **Interface Point**) and will include **Connection Site** (and in the case of **OTSDUW**, **Interface Point**) layout drawings, electrical layout drawings, common **Protection/control** drawings and common services drawings.

Preparation of Site Common Drawings for a User Site and Transmission Interface Site

ECC.7.5.2 In the case of a **User Site**, **The Company** shall prepare and submit to the **User**, **Site Common Drawings** for the **Transmission** side of the **Connection Point** (and in the case of **OTSDUW Plant and Apparatus**, on what will be the **Onshore Transmission** side of the **Interface Point**), and the **User** shall prepare and submit to **The Company**, **Site Common Drawings** for the **User** side of the **Connection Point** (and in the case of **OTSDUW**, on what will be the **Offshore Transmission** side of the **Interface Point**) in accordance with the timing requirements of the **Bilateral Agreement** and/or **Construction Agreement**.

ECC.7.5.3 The **User** will then prepare, produce and distribute, using the information submitted on the **Transmission Site Common Drawings**, **Site Common Drawings** for the complete **Connection Site** (and in the case of **OTSDUW**, **Interface Point**) in accordance with the timing requirements of the **Bilateral Agreement** and/or **Construction Agreement**.

Preparation of Site Common Drawings for a Transmission Site

ECC.7.5.4 In the case of a **Transmission Site**, the **User** will prepare and submit to **The Company Site Common Drawings** for the **User** side of the **Connection Point** in accordance with the timing requirements of the **Bilateral Agreement** and/or **Construction Agreement**.

ECC.7.5.5 **The Company** will then prepare, produce and distribute, using the information submitted in the **User's Site Common Drawings**, **Site Common Drawings** for the complete **Connection Site** in accordance with the timing requirements of the **Bilateral Agreement** and/or **Construction Agreement**.

ECC.7.5.6 When a **User** becomes aware that it is necessary to change any aspect of the **Site Common Drawings** at a **Connection Site** (and in the case of **OTSDUW**, **Interface Point**) it will:

- (a) if it is a **User Site**, as soon as reasonably practicable, prepare, produce and distribute revised **Site Common Drawings** for the complete **Connection Site** (and in the case of **OTSDUW**, **Interface Point**); and
- (b) if it is a **Transmission Site**, as soon as reasonably practicable, prepare and submit to **The Company** revised **Site Common Drawings** for the **User** side of the **Connection Point** (and in the case of **OTSDUW**, **Interface Point**) and **The Company** will then, as soon as reasonably practicable, prepare, produce and distribute, using the information submitted in the **User's Site Common Drawings**, revised **Site Common Drawings** for the complete **Connection Site** (and in the case of **OTSDUW**, **Interface Point**).

In either case, if in the **User's** reasonable opinion the change can be dealt with by it notifying **The Company** in writing of the change and for each party to amend its copy of the **Site Common Drawings** (or where there is only one set, for the party holding that set to amend it), then it shall so notify and each party shall so amend. If the change gives rise to a **Modification** under the **CUSC**, the provisions of the **CUSC** as to timing will apply.

ECC.7.5.7 When **The Company** becomes aware that it is necessary to change any aspect of the **Site Common Drawings** at a **Connection Site**(and in the case of **OTSDUW**, **Interface Point**) it will:

- (a) if it is a **Transmission Site**, as soon as reasonably practicable, prepare, produce and distribute revised **Site Common Drawings** for the complete **Connection Site** (and in the case of **OTSDUW**, **Interface Point**); and

- (b) if it is a **User Site**, as soon as reasonably practicable, prepare and submit to the **User** revised **Site Common Drawings** for the **Transmission** side of the **Connection Point** (in the case of **OTSDUW, Interface Point**) and the **User** will then, as soon as reasonably practicable, prepare, produce and distribute, using the information submitted in the **Transmission Site Common Drawings**, revised **Site Common Drawings** for the complete **Connection Site** (and in the case of **OTSDUW, Interface Point**).

In either case, if in **The Company's** reasonable opinion the change can be dealt with by it notifying the **User** in writing of the change and for each party to amend its copy of the **Site Common Drawings** (or where there is only one set, for the party holding that set to amend it), then it shall so notify and each party shall so amend. If the change gives rise to a **Modification** under the **CUSC**, the provisions of the **CUSC** as to timing will apply.

Validity

- ECC.7.5.8 (a) The **Site Common Drawings** for the complete **Connection Site** prepared by the **User** or **The Company**, as the case may be, will be the definitive **Site Common Drawings** for all operational and planning activities associated with the **Connection Site**. If a dispute arises as to the accuracy of the **Site Common Drawings**, a meeting shall be held at the **Site**, as soon as reasonably practicable, between **The Company** and the **User**, to endeavour to resolve the matters in dispute.
- (b) The **Site Common Drawing** prepared by **The Company** or the **User**, as the case may be, will be the definitive **Site Common Drawing** for all operational and planning activities associated with the **Interface Point** until the **OTSUA Transfer Time**. If a dispute arises as to the accuracy of the composite **Operation Diagram** prior to the **OTSUA Transfer Time**, a meeting shall be held at the **Interface Point**, as soon as reasonably practicable, between **The Company** and the **User**, to endeavour to resolve the matters in dispute.

ECC.7.5.9 In the case of **OTSUA**, a **User Site** and **Transmission Site** shall, for the purposes of this ECC.7.5, include a site at which there is an **Interface Point** until the **OTSUA Transfer Time** when it becomes part of the **National Electricity Transmission System**.

Access

ECC.7.6.1 The provisions relating to access to **Transmission Sites** by **Users**, and to **Users' Sites** by **Relevant Transmission Licensees**, are set out in each **Interface Agreement** (or in the case of **Interfaces Sites** prior to the **OTSUA Transfer Time** agreements in similar form) with, the **Relevant Transmission Licensee** and each **User**.

ECC.7.6.2 In addition to those provisions, where a **Transmission Site** contains exposed **HV** conductors, unaccompanied access will only be granted to individuals holding an **Authority for Access** issued by the **Relevant Transmission Licensee**.

ECC.7.6.3 The procedure for applying for an **Authority for Access** is contained in the **Interface Agreement**.

Maintenance Standards

ECC.7.7.1 It is the **User's** responsibility to ensure that all its **Plant** and **Apparatus** (including, until the **OTSUA Transfer Time**, any **OTSUA**) on a **Transmission Site** is tested and maintained adequately for the purpose for which it is intended, and to ensure that it does not pose a threat to the safety of any **Transmission Plant, Apparatus** or personnel on the **Transmission Site**. **The Company** will have the right to inspect the test results and maintenance records relating to such **Plant** and **Apparatus** at any time

ECC.7.7.2 For **User Sites**, **The Company** shall procure that the **Relevant Transmission Licensee** has a responsibility to ensure that all **Transmission Plant** and **Apparatus** on a **User Site** is tested and maintained adequately for the purposes for which it is intended and to ensure that it does not pose a threat to the safety of any **User's Plant, Apparatus** or personnel on the **User Site**.

The **User** will have the right to inspect the test results and maintenance records relating to such **Plant** and **Apparatus** on its **User Site** at any time.

ECC.7.8 Site Operational Procedures

ECC.7.8.1 Where there is an interface with **National Electricity Transmission System** **The Company** and **Users** must make available staff to take necessary **Safety Precautions** and carry out operational duties as may be required to enable work/testing to be carried out and for the operation of **Plant** and **Apparatus** (including, prior to the **OTSUA Transfer Time**, any **OTSUA**) connected to the **Total System**.

ECC.7.9 **Generators, HVDC System** owners and **BM Participants** (including **Virtual Lead Parties**) shall provide a **Control Point**.

- a) In the case of **EU Generators** and **HVDC System** owners, for each **Power Station** or **HVDC System** directly connected to the **National Electricity Transmission System** and for each **Embedded Large Power Station** or **Embedded HVDC System**, the **Control Point** shall receive and act upon instructions pursuant to OC7 and BC2 at all times that **Power Generating Modules** at the **Power Station** are generating or available to generate or **HVDC Systems** are importing or exporting or available to do so. In the case of all **BM Participants**, the **Control Point** shall be continuously staffed except where the **Bilateral Agreement** specifies that compliance with BC2 is not required, in which case the **Control Point** shall be staffed between the hours of 0800 and 1800 each day.
- b) In the case of **BM Participants**, the **BM Participant's Control Point** shall be capable of receiving and acting upon instructions from **The Company** and the relevant **Transmission Licensees' Control Engineers**.

The Company will normally issue instructions via automatic logging devices in accordance with the requirements of ECC.6.5.8(b).

Where the **BM Participant's Plant** and **Apparatus** does not respond to an instruction from **The Company** via automatic logging devices, or where it is not possible for **The Company** to issue the instruction via automatic logging devices, **The Company** shall issue the instruction by telephone.

In the case of **BM Participants** who own and/or operate a **Power Station** or **HVDC System** with an aggregated **Registered Capacity** or **BM Participants** with **BM Units** with an aggregated **Demand Capacity** per **Control Point** of less than 50MW, or, where a site is not part of a **Virtual Lead Party** as defined in the **BSC**, a **Registered Capacity** or **Demand Capacity** per site of less than 10MW

- a) where this situation arises, a representative of the **BM Participant** is required to be available to respond to instructions from **The Company** via the **Control Telephony** or **System Telephony** system, as provided for in ECC.6.5.4, between the hours of 0800-1800 each day.
- b) Outside the hours of 0800-1800 each day, the requirements of BC2.9.7 shall apply.

For the avoidance of doubt, **BM Participants** who are unable to provide **Control Telephony** and do not have a continuously staffed **Control Point** may be unable to act as a **Defence Service Provider** and shall be unable to act as a **Restoration Contractor** where these require **Control Telephony** or a **Control Point** in respect of the specification of any such services falling into these categories.

ECC.7.10 Obligations on Users in respect of Critical Tools and Facilities

ECC.7.10.1 From 04/09/2024 **The Company**, each **Generator, HVDC System Owner, Network Operator, Non-Embedded Customer** and each **Restoration Contractor** with a continuously staffed **Control Point** or **Control Centre** as provided for in ECC.7.9 shall:-

- (i) Ensure they have the appropriate **Critical Tools and Facilities**, necessary to control their assets for **System Restoration**, from their **Control Point** or **Control Centre**, as appropriate, for a minimum period of 72 hours (or such longer period as agreed between the **Generator, HVDC System Owner, Network Operator, Non-Embedded Customer** and/or **Restoration Contractor** and **The Company**) following a **Total Shutdown** or **Partial Shutdown**.

- (ii) Ensure as far as reasonably practical that they have adequate control equipment redundancy in place so that in the event of a failure of one or more components of the control system its function is unimpaired.
- (iii) Report on the results of their management and testing for their **Critical Tools and Facilities** on request from **The Company**.

ECC.7.10.2 From 04/09/2024 each **BM Participant** including a **Virtual Lead Party** with a continuously staffed **Control Point** as provided for in ECC.7.9 (excluding those **BM Participants** covered by the requirements of ECC.7.10.1), shall:-

- (i) Ensure they have the appropriate **Critical Tools and Facilities** (as defined in clause (c) of the definition of **Critical Tools and Facilities** in the **Grid Code Glossary and Definitions**) for a minimum period of 72 hours (or such longer period as agreed between the **BM Participant** including a **Virtual Lead Party** and **The Company**) following a **Total Shutdown** or **Partial Shutdown**.
- (ii) Ensure as far as reasonably practical that they have adequate control equipment redundancy in place at their **Control Point** so that in the event of a failure of one or more components of their **Critical Tools and Facilities** its function is unimpaired.
- (iii) Report on the results of their management and testing for their **Critical Tools and Facilities** on request by **The Company**.

ECC.7.10.3 In the case of a **BM Participant** or **Virtual Lead Party** which has an **Anchor Restoration Contract** or **Top Up Restoration Contract** in respect of one or more of its aggregated **Plants**, the requirements of ECC.7.10.1 shall only apply between the **Control Point** of the **BM Participant** or **Virtual Lead Party** and that **Plant** with an **Anchor Plant Capability** or **Top Up Restoration Capability**. For other non-contracted **Plants** under the control of the **BM Participant** or **Virtual Lead Party**, the requirements of ECC.7.10.2 shall continue to apply.

ECC.7.10.4 Where a **Network Operator** installs a **Distribution Restoration Zone Control System** to facilitate operation of a **Distribution Restoration Zone Plan**, the high level functional requirements of the **Distribution Restoration Zone Control System** shall be in accordance with the guidance provided in the applicable electrical standard listed in the annex to the **General Conditions**.

ECC.7.10.5 **Network Operators** shall ensure that their substations which are required to be operable during **System Restoration** have 72 hour electrical supply resilience to facilitate **Network Operators** being able to:

- restore auxiliary supplies to **Transmission** substations;
- switch **Demand** in accordance with a **Restoration Plan**;
- support **The Company** in satisfying the requirements of the **Electricity System Restoration Standard**.

ECC.7.10.6 **The Company**, each **EU Code User** and **Restoration Contractor** shall ensure their **Critical Tools and Facilities** are cyber secure accordance with the Security of Network and Information System (NIS) Regulations. This requirement applies to **The Company**, **EU Code Users** and **Restoration Contractors** at all times.

ECC.7.10.7 Notwithstanding the requirements of ECC.7.10.1, **The Company**, each **EU Code User** and **Restoration Contractor** shall ensure that their control systems, communications systems, operational metering and telemetry systems including SCADA, are sufficiently robust and reliable such that they are capable of handling, processing and prioritising the significant volumes of data that could reasonably be expected to occur during **System Restoration**.

ECC.7.10.8 Where an **Offshore Generator** is connected to an **Offshore Transmission System** and the **Offshore Transmission Licensee** does not have **Critical Tools and Facilities** installed on

its **Offshore Transmission System**, **The Company** will make an allowance for the **Critical Tools and Facilities** required to be installed by the **Offshore Generator**.

ECC.7.11 Obligations on and Assurance from The Company, EU Code Users and Restoration Contractors during Total Shutdown and Partial Shutdown conditions

ECC.7.11.1 In respect of **The Company**, its **Apparatus** shall be designed such that it can safely shutdown and does not pose a risk to personnel or **Apparatus** in the event of a total loss of supply.

ECC.7.11.2 All **EU Code Users** and **Restoration Contractors** shall ensure their **Plant** and **Apparatus** can safely shut down and does not pose a risk to **Plant** and/or personnel in the event of a total loss of supplies at a **EU Code User's Site(s)** or **Restoration Contractor's** site be it caused by a **Total Shutdown**, **Partial Shutdown** or such other event. In satisfying this requirement, **Generators**, **HVDC System Owners** and **Restoration Contractors** shall be able to demonstrate to **The Company** that in the event supplies were to be lost to their **Site**, then on the restoration of supplies, their **Plant** can be made operational and begin to operate in at least the same way and as quickly as would be expected for a cold start following a **Total System Shutdown** or **Partial System Shutdown** in accordance with the data submitted in PC.A.5.7 in accordance with the Week 24 process. For **EU Code Users** where they believe this requirement is cost prohibitive or technically impossible, such **EU Code Users** shall discuss the issue with **The Company**, and **The Company** shall inform **The Authority** of the details agreed. Where such an issue cannot be agreed by **The Company** following all reasonable attempts or where the capability provided by the **EU Code User** cannot be agreed by **The Company** as being sufficient after examining all reasonable alternative solutions through the **Compliance Processes**, the **EU Code User** may apply for a derogation from the Grid Code.

ECC.7.11.3 The requirements of ECC.7.11.1 and ECC.7.11.2 shall apply for a period of total loss of supplies to **The Company's** operational sites or an **EU Code User's Site** or **Restoration Contractor's** site of up to 72 hours. **EU Code Users** and **Restoration Contractors** shall confirm to **The Company** that the total loss of supplies to their **Site** for a period of up to 72 hours shall not result in damage to **Plant** and **Apparatus** such that it would then be unable to operate upon restoration of electrical supplies to the site.

ECC.7.11.4 **Network Operators** shall ensure that in coordination with **The Company** and relevant **Transmission Licensees**, they have the capability to switch **Demand** at sufficient speed to support **The Company** in satisfying the requirements of the **Electricity System Restoration Standard**. This requirement assumes:

- the successful implementation of **Restoration Plans**;
- the successful delivery of the obligations of **Restoration Contractors** who are parties to these plans; and
- the further requirements of OC9 have been implemented.

ECC.8 ANCILLARY SERVICES

ECC.8.1 System Ancillary Services

The **ECC** contain requirements for the capability for certain **Ancillary Services**, which are needed for **System** reasons ("**System Ancillary Services**"). There follows a list of these **System Ancillary Services**, together with the paragraph number of the **ECC** (or other part of the **Grid Code**) in which the minimum capability is required or referred to. The list is divided into two categories: Part 1 lists the **System Ancillary Services** which

- (a) **Generators** in respect of **Type C** and **Type D Power Generating Modules** (including **DC Connected Power Park Modules** and **Electricity Storage Modules**) are obliged to provide; and,
- (b) **HVDC System Owners** are obliged to have the capability to supply;
- (c) **Generators** in respect of **Medium Power Stations** (except **Embedded Medium Power Stations**) are obliged to provide in respect of **Reactive Power** only:

and Part 2 lists the **System Ancillary Services** which **Generators** or **Restoration Contractors** will provide only if agreement to provide them is reached with **The Company** or in the case where a **Restoration Contractor** is party to a **Distribution Restoration Zone Plan**, agreement is reached with **The Company** and **Network Operator**:

Part 1

- (a) **Reactive Power** supplied (in accordance with ECC.6.3.2)
- (b) **Frequency** Control by means of **Frequency** sensitive generation - ECC.6.3.7 and BC3.5.1.

Part 2

- (c) **Frequency** Control by means of **Fast Start** - ECC.6.3.14.
- (d) **Anchor Plant Capability** or **Top Up Restoration Capability** - ECC.6.3.5.
- (e) **System to Generator Operational Intertripping**.
- (f) Services provided by **Restoration Contractors**.

ECC.8.2 Commercial Ancillary Services

Other **Ancillary Services** are also utilised by **The Company** in operating the **Total System** if these have been agreed to be provided by a **User** (or other person) under an **Ancillary Services Agreement** or under a **Bilateral Agreement**, with payment being dealt with under an **Ancillary Services Agreement** or in the case of **Externally Interconnected System Operators** or **Interconnector Users**, under any other agreement (and in the case of **Externally Interconnected System Operators** and **Interconnector Users** includes ancillary services equivalent to or similar to **System Ancillary Services**) ("**Commercial Ancillary Services**"). The capability for these **Commercial Ancillary Services** is set out in the relevant **Ancillary Services Agreement** or **Bilateral Agreement** (as the case may be).

APPENDIX E1 - SITE RESPONSIBILITY SCHEDULES

FORMAT, PRINCIPLES AND BASIC PROCEDURE TO BE USED IN THE PREPARATION OF SITE RESPONSIBILITY SCHEDULES

ECC.A.1.1 Principles

Types of Schedules

ECC.A.1.1.1 At all **Complexes** (which in the context of this ECC shall include, **Interface Sites** until the **OTSUA Transfer Time**) the following **Site Responsibility Schedules** shall be drawn up using the relevant proforma attached or with such variations as may be agreed between **The Company** and **EU Code Users**, but in the absence of agreement the relevant proforma attached will be used. In addition, in the case of **OTSDUW Plant and Apparatus**, and in readiness for the **OTSUA Transfer Time**, the **User** shall provide **The Company** with the necessary information such that **Site Responsibility Schedules** in this form can be prepared by the **Relevant Transmission Licensees** for the **Transmission Interface Site**:

- (a) Schedule of **HV Apparatus**
- (b) Schedule of **Plant, LV/MV Apparatus**, services and supplies;
- (c) Schedule of telecommunications and measurements **Apparatus**.

Other than at **Power Generating Module** (including **DC Connected Power Park Modules**) and **Power Station** locations, the schedules referred to in (b) and (c) may be combined.

New Connection Sites

ECC.A.1.1.2 In the case of a new **Connection Site** each **Site Responsibility Schedule** for a **Connection Site** shall be prepared by **The Company** in consultation with relevant **Users** at least 2 weeks prior to the **Completion Date** (or, where the **OTSUA** is to become **Operational** prior to the **OTSUA Transfer Time**, an alternative date) under the **Bilateral Agreement** and/or **Construction Agreement** for that **Connection Site** (which may form part of a **Complex**). In the case of a new **Interface Site** where the **OTSUA** is to become **Operational** prior to the **OTSUA Transfer Time** each **Site Responsibility Schedule** for an **Interface Site** shall be prepared by **The Company** in consultation with relevant **Users** at least 2 weeks prior to the **Completion Date** under the **Bilateral Agreement** and/or **Construction Agreement** for that **Interface Site** (which may form part of a **Complex**) (and references to and requirements placed on "**Connection Site**" in this **ECC** shall also be read as "**Interface Site**" where the context requires and until the **OTSUA Transfer Time**). Each **User** shall, in accordance with the timing requirements of the **Bilateral Agreement** and/or **Construction Agreement**, provide information to **The Company** to enable it to prepare the **Site Responsibility Schedule**.

Sub-division

ECC.A.1.1.3 Each **Site Responsibility Schedule** will be subdivided to take account of any separate **Connection Sites** on that **Complex**.

Scope

ECC.A.1.1.4 Each **Site Responsibility Schedule** shall detail for each item of **Plant** and **Apparatus**:

- (a) **Plant/Apparatus** ownership;
- (b) Site Manager (Controller) (except in the case of **Plant/Apparatus** located in **SPT's Transmission Area**);
- (c) Safety issues comprising applicable **Safety Rules** and **Control Person** or other responsible person (**Safety Co-ordinator**), or such other person who is responsible for safety;
- (d) Operations issues comprising applicable **Operational Procedures** and control engineer;
- (e) Responsibility to undertake statutory inspections, fault investigation and maintenance.

Each **Connection Point** shall be precisely shown.

Detail

- ECC.A.1.1.5 (a) In the case of **Site Responsibility Schedules** referred to in ECC.A.1.1.1(b) and (c), with the exception of **Protection Apparatus** and **Intertrip Apparatus** operation, it will be sufficient to indicate the responsible **User** or **Transmission Licensee**, as the case may be.
- (b) In the case of the **Site Responsibility Schedule** referred to in ECC.A.1.1.1(a) and for **Protection Apparatus** and **Intertrip Apparatus**, the responsible management unit must be shown in addition to the **User** or **Transmission Licensee**, as the case may be.
- ECC.A.1.1.6 The **HV Apparatus Site Responsibility Schedule** for each **Connection Site** must include lines and cables emanating from or traversing¹ the **Connection Site**.

Issue Details

- ECC.A.1.1.7 Every page of each **Site Responsibility Schedule** shall bear the date of issue and the issue number.

Accuracy Confirmation

- ECC.A.1.1.8 When a **Site Responsibility Schedule** is prepared it shall be sent by **The Company** to the **Users** involved for confirmation of its accuracy.
- ECC.A.1.1.9 The **Site Responsibility Schedule** shall then be signed on behalf of **The Company** by its **Responsible Manager** (see ECC.A.1.1.16) and on behalf of each **User** involved by its **Responsible Manager** (see ECC.A.1.1.16), by way of written confirmation of its accuracy. The **Site Responsibility Schedule** will also be signed on behalf of the **Relevant Transmission Licensee** by its **Responsible Manager**.

Distribution and Availability

- ECC.A.1.1.10 Once signed, two copies will be distributed by **The Company**, not less than two weeks prior to its implementation date, to each **User** which is a party on the **Site Responsibility Schedule**, accompanied by a note indicating the issue number and the date of implementation.
- ECC.A.1.1.11 **The Company** and **Users** must make the **Site Responsibility Schedules** readily available to operational staff at the **Complex** and at the other relevant control points.

Alterations to Existing Site Responsibility Schedules

- ECC.A.1.1.12 Without prejudice to the provisions of ECC.A.1.1.15 which deals with urgent changes, when a **User** identified on a **Site Responsibility Schedule** becomes aware that an alteration is necessary, it must inform **The Company** immediately and in any event 8 weeks prior to any change taking effect (or as soon as possible after becoming aware of it, if less than 8 weeks remain when the **User** becomes aware of the change). This will cover the commissioning of new **Plant** and/or **Apparatus** at the **Connection Site**, whether requiring a revised **Bilateral Agreement** or not, de-commissioning of **Plant** and/or **Apparatus**, and other changes which affect the accuracy of the **Site Responsibility Schedule**.
- ECC.A.1.1.13 Where **The Company** has been informed of a change by a **User**, or itself proposes a change, it will prepare a revised **Site Responsibility Schedule** by not less than six weeks prior to the change taking effect (subject to it having been informed or knowing of the change eight weeks prior to that time) and the procedure set out in ECC.A.1.1.8 shall be followed with regard to the revised **Site Responsibility Schedule**.
- ECC.A.1.1.14 The revised **Site Responsibility Schedule** shall then be signed in accordance with the procedure set out in ECC.A.1.1.9 and distributed in accordance with the procedure set out in ECC.A.1.1.10, accompanied by a note indicating where the alteration(s) has/have been made, the new issue number and the date of implementation.

¹ Details of circuits traversing the **Connection Site** are only needed from the date which is the earlier of the date when the **Site Responsibility Schedule** is first updated and 15th October 2004. In Scotland or **Offshore**, from a date to be agreed between **The Company** and the **Relevant Transmission Licensee**.

Urgent Changes

ECC.A.1.1.15 When a **User** identified on a **Site Responsibility Schedule**, or **The Company**, as the case may be, becomes aware that an alteration to the **Site Responsibility Schedule** is necessary urgently to reflect, for example, an emergency situation which has arisen outside its control, the **User** shall notify **The Company**, or **The Company** shall notify the **User**, as the case may be, immediately and will discuss:

- (a) what change is necessary to the **Site Responsibility Schedule**;
- (b) whether the **Site Responsibility Schedule** is to be modified temporarily or permanently;
- (c) the distribution of the revised **Site Responsibility Schedule**.

The Company will prepare a revised **Site Responsibility Schedule** as soon as possible, and in any event within seven days of it being informed of or knowing the necessary alteration. The **Site Responsibility Schedule** will be confirmed by **Users** and signed on behalf of **The Company** and **Users** and the **Relevant Transmission Licensee** (by the persons referred to in ECC.A.1.1.9) as soon as possible after it has been prepared and sent to **Users** for confirmation.

Responsible Managers

ECC.A.1.1.16 Each **User** shall, prior to the **Completion Date** under each **Bilateral Agreement** and/or **Construction Agreement**, supply to **The Company** a list of Managers who have been duly authorised to sign **Site Responsibility Schedules** on behalf of the **User** and **The Company** shall, prior to the **Completion Date** under each **Bilateral Agreement** and/or **Construction Agreement**, supply to that **User** the name of its **Responsible Manager** and the name of the **Relevant Transmission Licensee's Responsible Manager** and each shall supply to the other any changes to such list six weeks before the change takes effect where the change is anticipated, and as soon as possible after the change, where the change was not anticipated.

De-commissioning of Connection Sites

ECC.A.1.1.17 Where a **Connection Site** is to be de-commissioned, whichever of **The Company** or the **User** who is initiating the de-commissioning must contact the other to arrange for the **Site Responsibility Schedule** to be amended at the relevant time.

PROFORMA FOR SITE RESPONSIBILITY SCHEDULE

AREA _____

COMPLEX: _____

SCHEDULE: _____

CONNECTION SITE: _____

ITEM OF PLANT/ APPARATUS	PLANT APPARATUS OWNER	SITE MANAGER	SAFETY		OPERATIONS		PARTY RESPONSIBLE FOR UNDERTAKING STATUTORY INSPECTIONS, FAULT INVESTIGATION & MAINTENANCE	REMARKS
			SAFETY RULES	CONTROL OR OTHER RESPONSIBLE PERSON (SAFETY CO-ORDINATOR)	OPERATIONAL PROCEDURES	CONTROL OR OTHER RESPONSIBLE ENGINEER		

--	--	--	--	--	--	--	--	--

PAGE: _____ ISSUE NO: _____ DATE: _____

PROFORMA FOR SITE RESPONSIBILITY SCHEDULE

AREA _____

COMPLEX: _____

SCHEDULE: _____

CONNECTION SITE: _____

ITEM OF PLANT/ APPARATUS	PLANT APPARATUS OWNER	SITE MANAGER	SAFETY		OPERATIONS		PARTY RESPONSIBLE FOR UNDERTAKING STATUTORY INSPECTIONS, FAULT INVESTIGATION & MAINTENANCE	REMARKS
			SAFETY RULES	CONTROL OR OTHER RESPONSIBLE PERSON (SAFETY CO-ORDINATOR)	OPERATIONAL PROCEDURES	CONTROL OR OTHER RESPONSIBLE ENGINEER		

NOTES:

SIGNATURE: _____ NAME: _____ COMPANY: _____ DATE: _____

SIGNATURE: _____ NAME: _____ COMPANY: _____ DATE: _____

SIGNATURE: _____ NAME: _____ COMPANY: _____ DATE: _____

SIGNATURE: _____ NAME: _____ COMPANY: _____ DATE: _____

PAGE: _____ ISSUE NO: _____ DATE: _____

**SP TRANSMISSION Ltd
 SITE RESPONSIBILITY SCHEDULE
 OWNERSHIP, MAINTENANCE AND OPERATIONS OF EQUIPMENT
 IN JOINT USER SITUATIONS**

Network Area: _____

Sheet No. _____
 Revision: _____
 Date: _____

SECTION 'A' BUILDING AND SITE

SECTION 'B' CUSTOMER OR OTHER PARTY

OWNER		ACCESS REQUIRED:-		NAME:-				
LESSEE								
MAINTENANCE		SPECIAL CONDITIONS:-		ADDRESS:-				
SAFETY				TEL NO:-				
SECURITY		LOCATION OF SUPPLY TERMINALS:-		SUB STATION:-				
				LOCATION:-				

SECTION 'C' PLANT

ITEM Nos.	EQUIPMENT	IDENTIFICATION	OWNER	SAFETY RULES APPLICABLE	OPERATION				MAINTENANCE		FAULT INVESTIGATION			TESTING		RELAY SETTINGS	REMARKS
					Tripping	Closing	Isolating	Earthing	Primary Equip.	Protection Equip.	Primary Equip.	Protection Equip.	Reclosure	Trip and Alarm	Primary Equip.		

SECTION 'D' CONFIGURATION AND CONTROL

ITEM Nos.	CONFIGURATION RESPONSIBILITY	TELEPHONE NUMBER	REMARKS
ITEM Nos.	CONTROL RESPONSIBILITY	TELEPHONE NUMBER	REMARKS

SECTION 'E' ADDITIONAL INFORMATION

ABBREVIATIONS:-

- D - SP AUTHORIZED PERSON - DISTRIBUTION SYSTEM
- NGC - NATIONAL GRID COMPANY
- SPD - SP DISTRIBUTION Ltd
- SPPS - POWERSYSTEMS
- SPT - SP TRANSMISSION Ltd
- ST - SCOTTISH POWER TELECOMMUNICATIONS
- T - SP AUTHORIZED PERSON - TRANSMISSION SYSTEM
- U - USER

SIGNED _____ FOR SP Transmission DATE _____

SIGNED _____ FOR SP Distribution DATE _____

SIGNED _____ FOR PowerSystems/User DATE _____















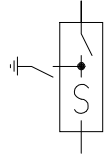





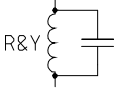

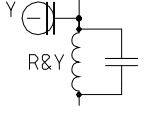

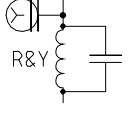

Scottish Hydro-Electric Transmission Limited

Site Responsibility Schedule

Substation Type										Number:		Revision:	
Equipment	Owner	Controller	Maintainer	Responsible System User	Responsible Management Unit	Control Authority	Safety Rules	Operational Procedures	Notes				

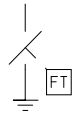
APPENDIX E2 - OPERATION DIAGRAMS

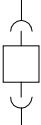
PART 1A - PROCEDURES RELATING TO OPERATION DIAGRAMS

FIXED CAPACITOR		SWITCH DISCONNECTOR	
EARTH			
EARTHING RESISTOR		SWITCH DISCONNECTOR WITH INCORPORATED EARTH SWITCH	
LIQUID EARTHING RESISTOR			
ARC SUPPRESSION COIL		DISCONNECTOR (CENTRE ROTATING POST)	
FIXED MAINTENANCE EARTHING DEVICE		DISCONNECTOR (SINGLE BREAK DOUBLE ROTATING)	
CARRIER COUPLING EQUIPMENT (WITHOUT VT)		DISCONNECTOR (SINGLE BREAK)	
CARRIER COUPLING EQUIPMENT (WITH VT ON ONE PHASE)		DISCONNECTOR (NON-INTERLOCKED)	
CARRIER COUPLING EQUIPMENT (WITH VT ON 3 PHASES)		DISCONNECTOR (POWER OPERATED) NA - NON-AUTOMATIC A - AUTOMATIC SO - SEQUENTIAL OPERATION FI - FAULT INTERFERING OPERATION	
AC GENERATOR		EARTH SWITCH	
SYNCHRONOUS COMPENSATOR			
CIRCUIT BREAKER		FAULT THROWING SWITCH (PHASE TO PHASE)	
CIRCUIT BREAKER WITH DELAYED AUTO RECLOSE		FAULT THROWING SWITCH (EARTH FAULT)	
		SURGE ARRESTOR	
WITHDRAWABLE METALCLAD SWITCHGEAR		THYRISTOR	

TRANSFORMERS
(VECTORS TO INDICATE
WINDING CONFIGURATION)

TWO WINDING



THREE WINDING

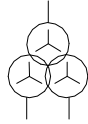

AUTO



AUTO WITH DELTA TERTIARY

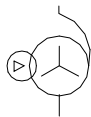

EARTHING OR AUX. TRANSFORMER

(-) INDICATE REMOTE SITE
IF APPLICABLE

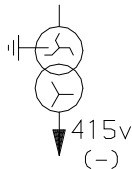

VOLTAGE TRANSFORMERS

SINGLE PHASE WOUND



THREE PHASE WOUND



SINGLE PHASE CAPACITOR



TWO SINGLE PHASE CAPACITOR

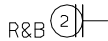

THREE PHASE CAPACITOR



* CURRENT TRANSFORMER
(WHERE SEPARATE PRIMARY
APPARATUS)



* COMBINED VT/CT UNIT
FOR METERING

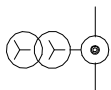

REACTOR



* BUSBARS



* OTHER PRIMARY CONNECTIONS



* CABLE & CABLE SEALING END

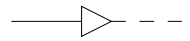

* THROUGH WALL BUSHING

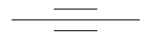

* BYPASS FACILITY



* CROSSING OF CONDUCTORS
(LOWER CONDUCTOR
TO BE BROKEN)

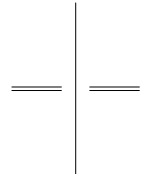

PREFERENTIAL ABBREVIATIONS

AUXILIARY TRANSFORMER	Aux T
EARTHING TRANSFORMER	ET
GAS TURBINE	Gas T
GENERATOR TRANSFORMER	Gen T
GRID TRANSFORMER	Gr T
SERIES REACTOR	Ser Reac
SHUNT REACTOR	Sh Reac
STATION TRANSFORMER	Stn T
SUPERGRID TRANSFORMER	SGT
UNIT TRANSFORMER	UT

* NON-STANDARD SYMBOL

PORTABLE MAINTENANCE
EARTH DEVICE



DISCONNECTOR
(PANTOGRAPH TYPE)



QUADRATURE BOOSTER

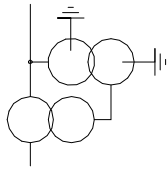

DISCONNECTOR
(KNEE TYPE)



SHORTING/DISCHARGE SWITCH

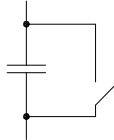

CAPACITOR
(INCLUDING HARMONIC FILTER)



SINGLE PHASE TRANSFORMER (BR)
NEUTRAL AND PHASE CONNECTIONS

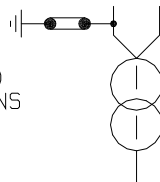

RESISTOR WITH INHERENT
NON-LINEAR VARIABILITY,
VOLTAGE DEPENDANT

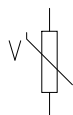

PART E1B - PROCEDURES RELATING TO GAS ZONE DIAGRAMS

GAS INSULATED
BUSBAR

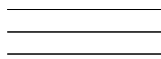

DOUBLE-BREAK
DISCONNECTOR

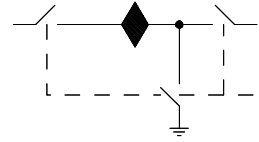

GAS BOUNDARY



EXTERNAL MOUNTED
CURRENT TRANSFORMER
(WHERE SEPARATE
PRIMARY APPARATUS)



GAS/GAS BOUNDARY



STOP VALVE
NORMALLY CLOSED



GAS/CABLE BOUNDARY



STOP VALVE
NORMALLY OPEN



GAS/AIR BOUNDARY



GAS MONITOR



GAS/TRANSFORMER BOUNDARY



FILTER



MAINTENANCE VALVE

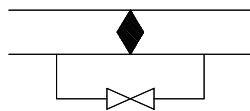

QUICK ACTING COUPLING



PART E2 - NON-EXHAUSTIVE LIST OF APPARATUS TO BE INCLUDED ON OPERATION DIAGRAMS

Basic Principles

- (1) Where practicable, all the **HV Apparatus** on any **Connection Site** shall be shown on one **Operation Diagram**. Provided the clarity of the diagram is not impaired, the layout shall represent as closely as possible the geographical arrangement on the **Connection Site**.
- (2) Where more than one **Operation Diagram** is unavoidable, duplication of identical information on more than one **Operation Diagram** must be avoided.
- (3) The **Operation Diagram** must show accurately the current status of the **Apparatus** e.g. whether commissioned or decommissioned. Where decommissioned, the associated switchbay will be labelled "spare bay".
- (4) Provision will be made on the **Operation Diagram** for signifying approvals, together with provision for details of revisions and dates.
- (5) **Operation Diagrams** will be prepared in A4 format or such other format as may be agreed with **The Company**.
- (6) The **Operation Diagram** should normally be drawn single line. However, where appropriate, detail which applies to individual phases shall be shown. For example, some **HV Apparatus** is numbered individually per phase.

Apparatus To Be Shown On Operation Diagram

- (1) Busbars
- (2) Circuit Breakers
- (3) Disconnecter (Isolator) and Switch Disconnecters (Switching Isolators)
- (4) Disconnectors (Isolators) - Automatic Facilities
- (5) Bypass Facilities
- (6) Earthing Switches
- (7) Maintenance Earths
- (8) Overhead Line Entries
- (9) Overhead Line Traps
- (10) Cable and Cable Sealing Ends
- (11) Generating Unit
- (12) Generator Transformers
- (13) Generating Unit Transformers, Station Transformers, including the lower voltage circuit-breakers.
- (14) Synchronous Compensators
- (15) Static Variable Compensators
- (16) Capacitors (including Harmonic Filters)
- (17) Series or Shunt Reactors (Referred to as "Inductors" at nuclear power station sites)
- (18) Supergrid and Grid Transformers
- (19) Tertiary Windings
- (20) Earthing and Auxiliary Transformers
- (21) Three Phase VT's

- (22) Single Phase VT & Phase Identity
- (23) High Accuracy VT and Phase Identity
- (24) Surge Arrestors/Diverter
- (25) Neutral Earthing Arrangements on HV Plant
- (26) Fault Throwing Devices
- (27) Quadrature Boosters
- (28) Arc Suppression Coils
- (29) Single Phase Transformers (BR) Neutral and Phase Connections
- (30) Current Transformers (where separate plant items)
- (31) Wall Bushings
- (32) Combined VT/CT Units
- (33) Shorting and Discharge Switches
- (34) Thyristor
- (35) Resistor with Inherent Non-Linear Variability, Voltage Dependent
- (36) Gas Zone

APPENDIX E3 - MINIMUM FREQUENCY RESPONSE CAPABILITY REQUIREMENT PROFILE AND OPERATING RANGE FOR POWER GENERATING MODULES AND HVDC EQUIPMENT

ECC.A.3.1 Scope

The frequency response capability is defined in terms of **Primary Response**, **Secondary Response** and **High Frequency Response**. In addition to the requirements defined in ECC.6.3.7 this appendix defines the minimum frequency response requirements for:-

- (a) each **Type C** and **Type D Power Generating Module**
- (b) each **DC Connected Power Park Module**
- (c) each **HVDC System**

For the avoidance of doubt, this appendix does not apply to **Type A** and **Type B Power Generating Modules**.

OTSDUW Plant and Apparatus should facilitate the delivery of frequency response services provided by **Offshore Generating Units** and **Offshore Power Park Units**.

The functional definition provides appropriate performance criteria relating to the provision of **Frequency** control by means of **Frequency** sensitive generation in addition to the other requirements identified in ECC.6.3.7.

In this Appendix 3 to the **ECC**, for a **Power Generating Module** including a **CCGT Module** or a **Power Park Module** or **DC Connected Power Park Module**, the phrase **Minimum Regulating Level** applies to the entire **CCGT Module** or **Power Park Module** or **DC Connected Power Park Module** operating with all **Generating Units Synchronised** to the **System**.

The minimum **Frequency** response requirement profile is shown diagrammatically in Figure ECC.A.3.1. The capability profile specifies the minimum required level of **Frequency Response** Capability throughout the normal plant operating range.

ECC.A.3.2 Plant Operating Range

The upper limit of the operating range is the **Maximum Capacity** of the **Power Generating Module** or **Generating Unit** or **CCGT Module** or **HVDC Equipment**.

The **Minimum Stable Operating Level** may be less than, but must not be more than, 65% of the **Maximum Capacity**. Each **Power Generating Module** and/or **Generating Unit** and/or **CCGT Module** and/or **Power Park Module** or **HVDC Equipment** must be capable of operating satisfactorily down to the **Minimum Regulating Level** as dictated by **System** operating conditions, although it will not be instructed to below its **Minimum Stable Operating Level**. If a **Power Generating Module** or **Generating Unit** or **CCGT Module** or **Power Park Module**, or **HVDC Equipment** is operating below **Minimum Stable Operating Level** because of high **System Frequency**, it should recover adequately to its **Minimum Stable Operating Level** as the **System Frequency** returns to **Target Frequency** so that it can provide **Primary** and **Secondary Response** from its **Minimum Stable Operating Level** if the **System Frequency** continues to fall. For the avoidance of doubt, under normal operating conditions steady state operation below the **Minimum Stable Operating Level** is not expected. The **Minimum Regulating Level** must not be more than 55% of **Maximum Capacity**.

In the event of a **Power Generating Module** or **Generating Unit** or **CCGT Module** or **Power Park Module** or **HVDC Equipment** load rejecting down to no less than its **Minimum Regulating Level** it should not trip as a result of automatic action as detailed in BC3.7. If the load rejection is to a level less than the **Minimum Regulating Level** then it is accepted that the condition might be so severe as to cause it to be disconnected from the **System**.

ECC.A.3.3 Minimum Frequency Response Requirement Profile

Figure ECC.A.3.1 shows the minimum **Frequency** response capability requirement profile diagrammatically for a 0.5 Hz change in **Frequency**. The percentage response capabilities and loading levels are defined on the basis of the **Maximum Capacity** of the **Power Generating Module** or **CCGT Module** or **Power Park Module** or **HVDC Equipment**. Each **Power Generating Module** or and/or **CCGT Module** or **Power Park Module** (including a **DC Connected Power Park Module**) and/or **HVDC Equipment** must be capable of operating in a manner to provide **Frequency** response at least to the solid boundaries shown in the figure. If the **Frequency** response capability falls within the solid boundaries, the **Power Generating Module** or **CCGT Module** or **Power Park Module** or **HVDC Equipment** is providing response below the minimum requirement which is not acceptable. Nothing in this appendix is intended to prevent a **Power Generating Module** or **CCGT Module** or **Power Park Module** or **HVDC Equipment** from being designed to deliver a **Frequency** response in excess of the identified minimum requirement.

The **Frequency** response delivered for **Frequency** deviations of less than 0.5 Hz should be no less than a figure which is directly proportional to the minimum **Frequency** response requirement for a **Frequency** deviation of 0.5 Hz. For example, if the **Frequency** deviation is 0.2 Hz, the corresponding minimum **Frequency** response requirement is 40% of the level shown in Figure ECC.A.3.1. The **Frequency** response delivered for **Frequency** deviations of more than 0.5 Hz should be no less than the response delivered for a **Frequency** deviation of 0.5 Hz.

Each **Power Generating Module** and/or **CCGT Module** and/or **Power Park Module** or **HVDC Equipment** must be capable of providing some response, in keeping with its specific operational characteristics, when operating between 95% to 100% of **Maximum Capacity** as illustrated by the dotted lines in Figure ECC.A.3.1.

At the **Minimum Stable Operating** level, each **Power Generating Module** and/or **CCGT Module** and/or **Power Park Module** and/or **HVDC Equipment** is required to provide high and low frequency response depending on the **System Frequency** conditions. Where the **Frequency** is high, the **Active Power** output is therefore expected to fall below the **Minimum Stable Operating** level.

The **Minimum Regulating Level** is the output at which a **Power Generating Module** and/or **CCGT Module** and/or **Power Park Module** and/or **HVDC Equipment** has no **High Frequency Response** capability. It may be less than, but must not be more than, 55% of the **Maximum Capacity**. This implies that a **Power Generating Module** or **CCGT Module** or **Power Park Module**) or **HVDC Equipment** is not obliged to reduce its output to below this level unless the **Frequency** is at or above 50.5 Hz (cf BC3.7).

ECC.A.3.4 Testing of Frequency Response Capability

The frequency response capabilities shown diagrammatically in Figure ECC.A.3.1 are measured by taking the responses as obtained from some of the dynamic step response tests specified by **The Company** and carried out by **Generators** and **HVDC System** owners for compliance purposes. The injected signal is a step of 0.5Hz from zero to 0.5 Hz **Frequency** change, and is sustained at 0.5 Hz **Frequency** change thereafter, the latter as illustrated diagrammatically in figures ECC.A.3.4 and ECC.A.3.5.

In addition to provide and/or to validate the content of **Ancillary Services Agreements** a progressive injection of a **Frequency** change to the plant control system (i.e. governor and load controller) is used. The injected signal is a ramp of 0.5Hz from zero to 0.5 Hz **Frequency** change over a ten second period, and is sustained at 0.5 Hz **Frequency** change thereafter, the latter as illustrated diagrammatically in figures ECC.A.3.2 and ECC.A.3.3. In the case of an **Embedded Medium Power Station** not subject to a **Bilateral Agreement** or **Embedded HVDC System** not subject to a **Bilateral Agreement**, **The Company** may require the **Network Operator** within whose System the **Embedded Medium Power Station** or **Embedded HVDC System** is situated, to ensure that the **Embedded Person** performs the dynamic response tests reasonably required by **The Company** in order to demonstrate compliance within the relevant requirements in the **ECC**.

The **Primary Response** capability (P) of a **Power Generating Module** or a **CCGT Module** or **Power Park Module** or **HVDC Equipment** is the minimum increase in **Active Power** output between 10 and 30 seconds after the start of the ramp injection as illustrated diagrammatically in Figure ECC.A.3.2. This increase in **Active Power** output should be released increasingly with time over the period 0 to 10 seconds from the time of the start of the **Frequency** fall as illustrated by the response from Figure ECC.A.3.2.

The **Secondary Response** capability (S) of a **Power Generating Module** or a **CCGT Module** or **Power Park Module** or **HVDC Equipment** is the minimum increase in **Active Power** output between 30 seconds and 30 minutes after the start of the ramp injection as illustrated diagrammatically in Figure ECC.A.3.2.

The **High Frequency Response** capability (H) of a **Power Generating Module** or a **CCGT Module** or **Power Park Module** or **HVDC Equipment** is the decrease in **Active Power** output provided 10 seconds after the start of the ramp injection and sustained thereafter as illustrated diagrammatically in Figure ECC.A.3.3. This reduction in **Active Power** output should be released increasingly with time over the period 0 to 10 seconds from the time of the start of the **Frequency** rise as illustrated by the response in Figure ECC.A.3.2.

ECC.A.3.5 Repeatability of Response

When a **Power Generating Module** or **CCGT Module** or **Power Park Module** or **HVDC Equipment** has responded to a significant **Frequency** disturbance, its response capability must be fully restored as soon as technically possible. Full response capability should be restored no later than 20 minutes after the initial change of **System Frequency** arising from the **Frequency** disturbance.

Figure ECC.A.3.1 - Minimum **Frequency** Response requirement profile for a 0.5 Hz frequency change from **Target Frequency**

Figure ECC.A.3.1 – Minimum Frequency Response Capability Requirement Profile for a 0.5Hz change from Target Frequency

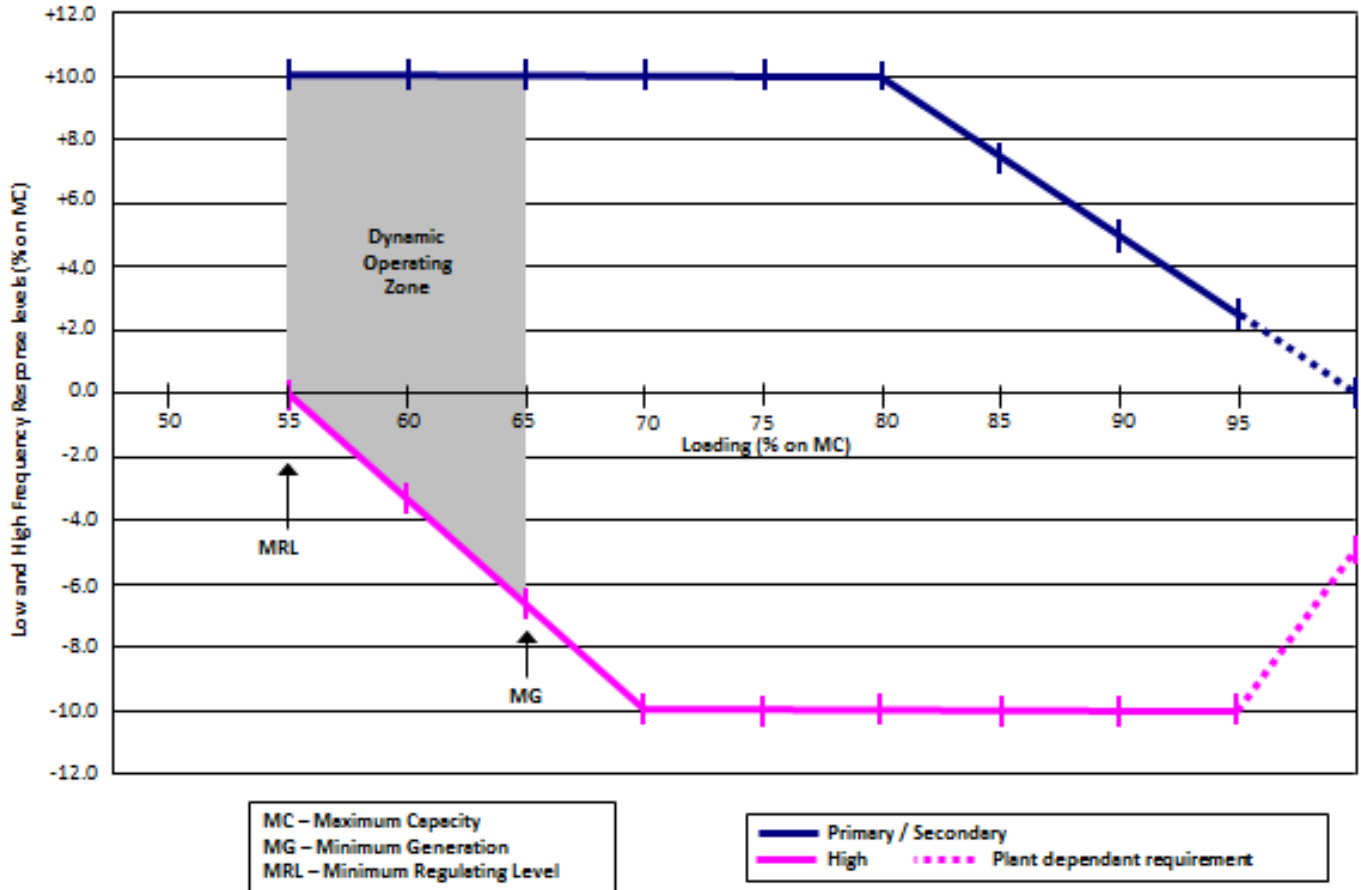

Figure ECC.A.3.2 – Interpretation of Primary and Secondary Response Service Values

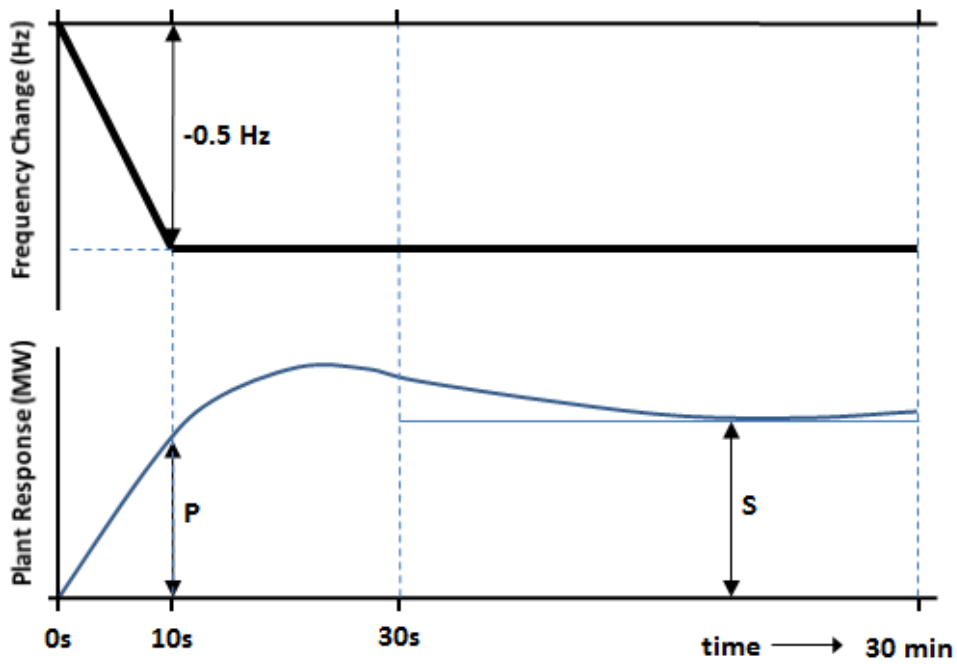

Figure ECC.A.3.3 – Interpretation of High Frequency Response Service Values

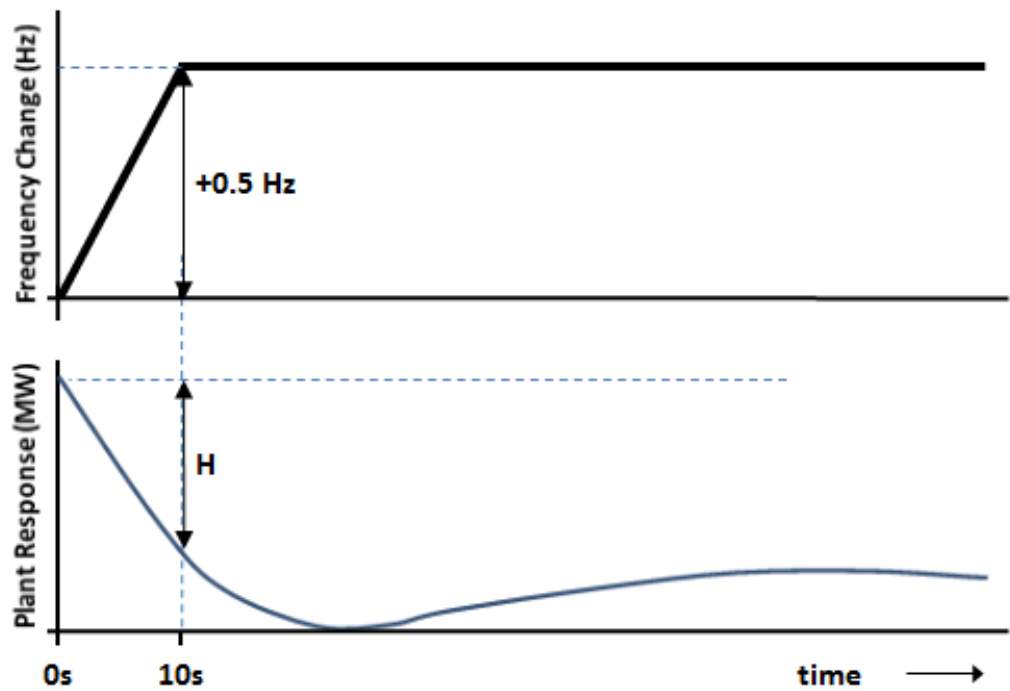

Figure ECC.A.3.4 – Interpretation of Low Frequency Response Capability Values

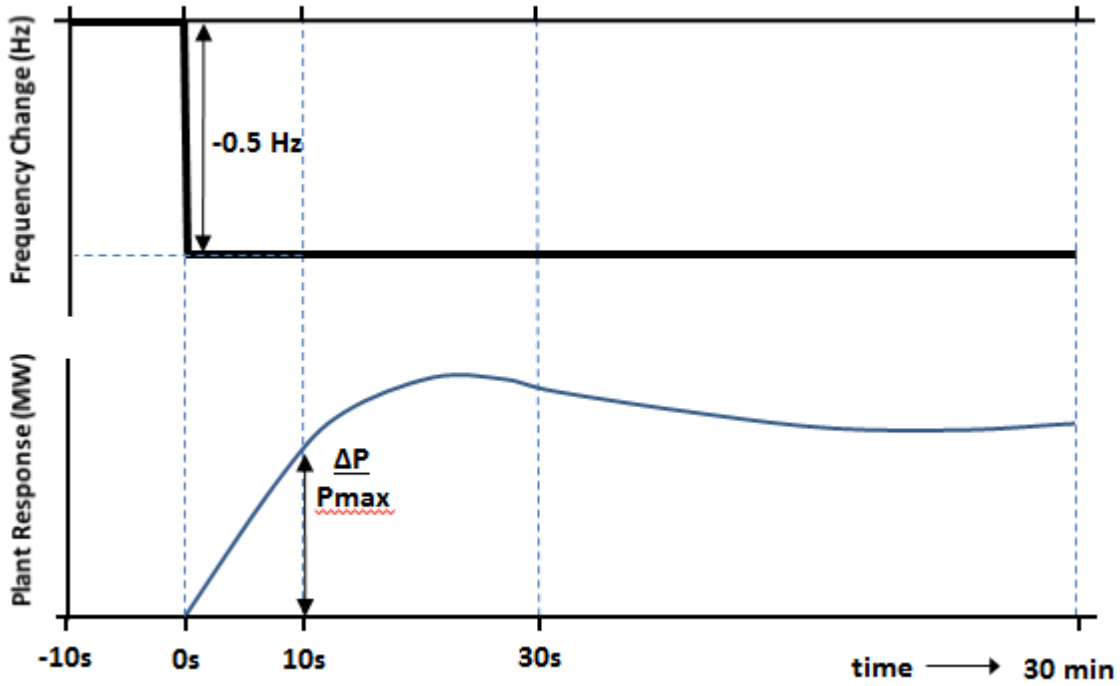
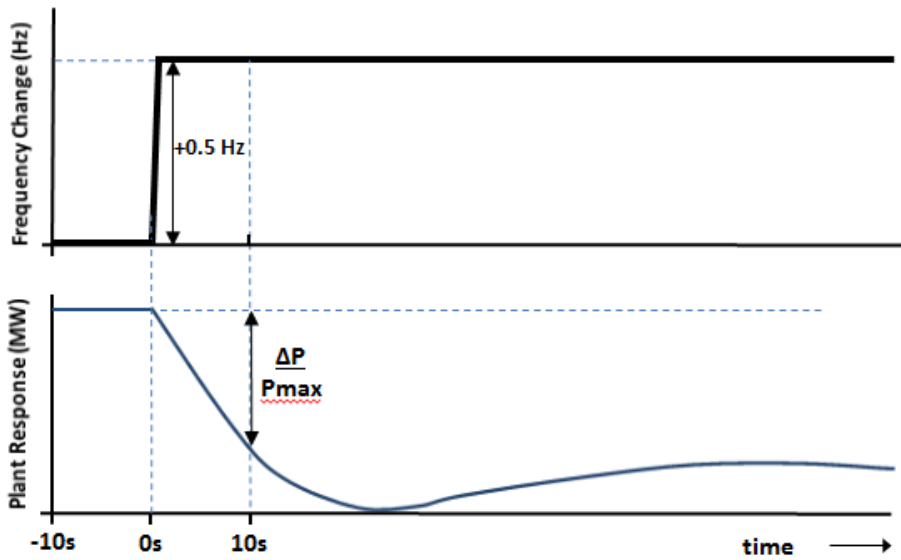

Figure ECC.A.3.5 – Interpretation of High Frequency Response Capability Values



ECC.4 - APPENDIX 4 - FAULT RIDE THROUGH REQUIREMENTS

FAULT RIDE THROUGH REQUIREMENTS FOR TYPE B, TYPE C AND TYPE D POWER GENERATING MODULES (INCLUDING OFFSHORE POWER PARK MODULES WHICH ARE EITHER AC CONNECTED POWER PARK MODULES OR DC CONNECTED POWER PARK MODULES), HVDC SYSTEMS AND OTSDUW PLANT AND APPARATUS

ECC.A.4A.1 Scope

The **Fault Ride Through** requirements are defined in ECC.6.3.15. This Appendix provides illustrations by way of examples only of ECC.6.3.15.1 to ECC.6.3.15.10 and further background and illustrations and is not intended to show all possible permutations.

ECC.A.4A.2 Short Circuit Faults At Supergrid Voltage On The Onshore Transmission System Up To 140ms In Duration

For short circuit faults at **Supergrid Voltage** on the **Onshore Transmission System** (which could be at an **Interface Point**) up to 140ms in duration, the **Fault Ride Through** requirement is defined in ECC.6.3.15. In summary any **Power Generating Module** (including a **DC Connected Power Park Module**) or **HVDC System** is required to remain connected and stable whilst connected to a healthy circuit. Figure ECC.A.4.A.2 illustrates this principle.

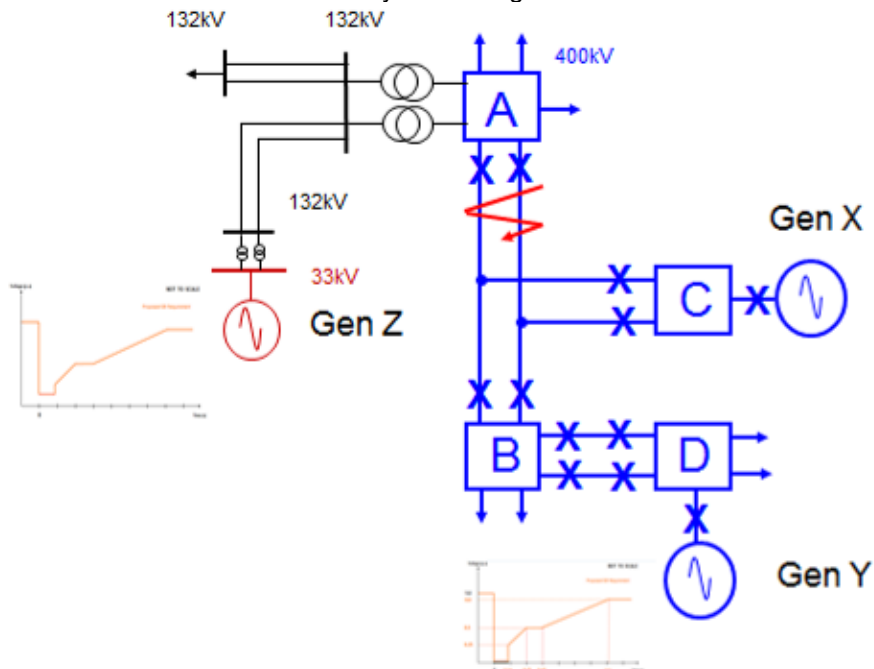

Figure ECC.A.4.A.2

In Figure ECC.A.4.A.2 a solid three phase short circuit fault is applied adjacent to substation A resulting in zero voltage at the point of fault. All circuit breakers on the faulty circuit (Lines ABC) will open within 140ms resulting in Gen X tripping. The effect of this fault, due to the low impedance of the network, will be the observation of a low voltage at each substation node across the **Total System** until the fault has been cleared. In this example, Gen Y and Gen Z (an Embedded Generator) would need to remain connected and stable as both are still connected to the **Total System** and remain connected to healthy circuits .

The criteria for assessment is based on a voltage against time curve at each **Grid Entry Point** or **User System Entry Point**. The voltage against time curve at the **Grid Entry Point** or **User System Entry Point** varies for each different type and size of **Power Generating Module** as detailed in ECC.6.3.15.2. – ECC.6.3.15.7.

The voltage against time curve represents the voltage profile at a **Grid Entry Point** or **User System Entry Point** that would be obtained by plotting the voltage at that **Grid Entry Point** or **User System Entry Point** before during and after the fault. This is not to be confused with a voltage duration curve (as defined under ECC.6.3.15.9) which represents a voltage level and associated time duration.

The post fault voltage at a **Grid Entry Point** or **User System Entry Point** is largely influenced by the topology of the network rather than the behaviour of the **Power Generating Module** itself. The **EU Generator** therefore needs to ensure each **Power Generating Module** remains connected and stable for a close up solid three phase short circuit fault for 140ms at the **Grid Entry Point** or **User System Entry Point**.

Two examples are shown in Figure EA.4.2(a) and Figure EA4.2(b). In Figure EA.4.2(a) the post fault profile is above the heavy black line. In this case the **Power Generating Module** must remain connected and stable. In Figure EA4.2(b) the post fault voltage dips below the heavy black line in which case the **Power Generating Module** is permitted to trip.

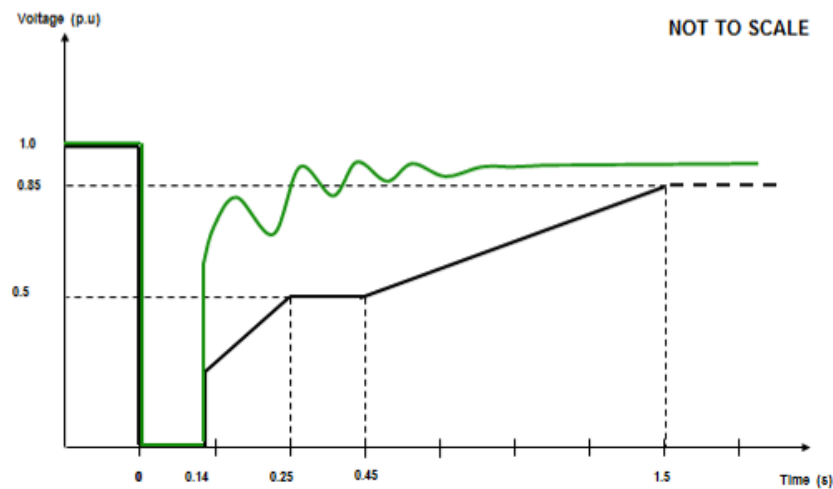

Figure EA.4.2(a)

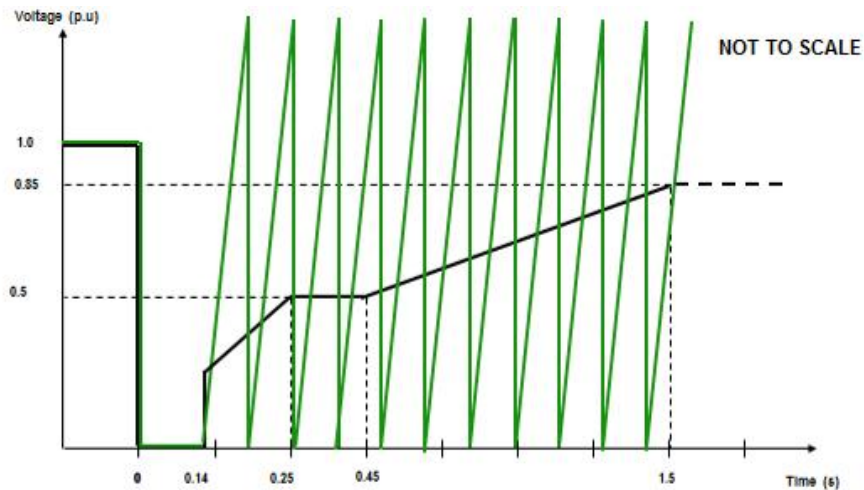

Figure EA.4.2(b)

The process for demonstrating **Fault Ride Through** compliance against the requirements of ECC.6.3.15 is detailed in ECP.A.3.5 and ECP.A.6.7 (as applicable).

ECC.A.4A.3 Supergrid Voltage Dips On The Onshore Transmission System Greater Than 140ms In Duration

ECC.A.4A3.1 Requirements applicable to **Synchronous Power Generating Modules** subject to **Supergrid Voltage** dips on the **Onshore Transmission System** greater than 140ms in duration.

For balanced **Supergrid Voltage** dips on the **Onshore Transmission System** having durations greater than 140ms and up to 3 minutes, the **Fault Ride Through** requirement is defined in ECC.6.3.15.9.2.1(a) and Figure ECC.6.3.15.9(a) which is reproduced in this Appendix as Figure EA.4.3.1 and termed the voltage–duration profile.

This profile is not a voltage-time response curve that would be obtained by plotting the transient voltage response at a point on the **Onshore Transmission System** (or **User System** if located **Onshore**) to a disturbance. Rather, each point on the profile (ie the heavy black line) represents a voltage level and an associated time duration which connected **Synchronous Power Generating Modules** must withstand or ride through.

Figures EA.4.3.2 (a), (b) and (c) illustrate the meaning of the voltage-duration profile for voltage dips having durations greater than 140ms.

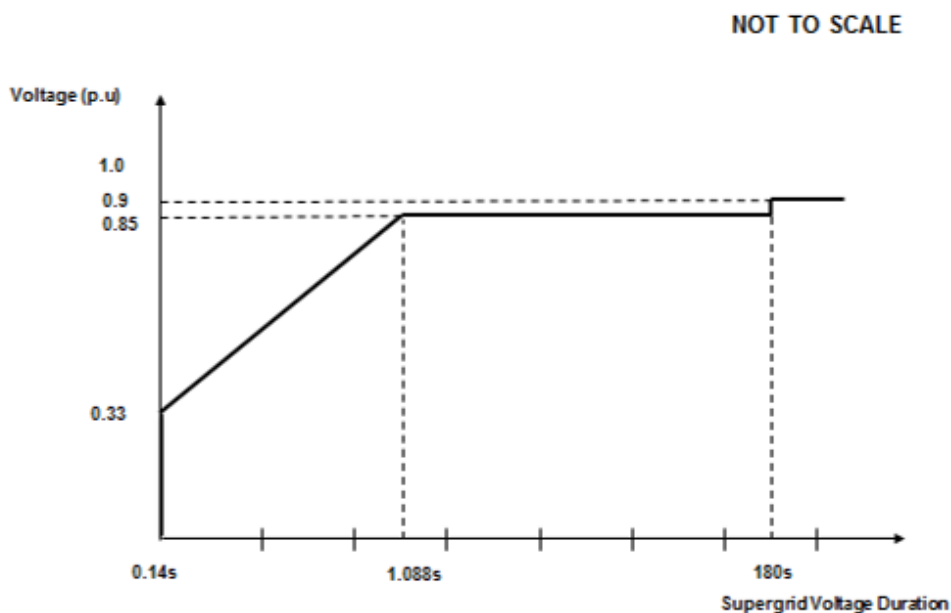

Figure EA.4.3.1

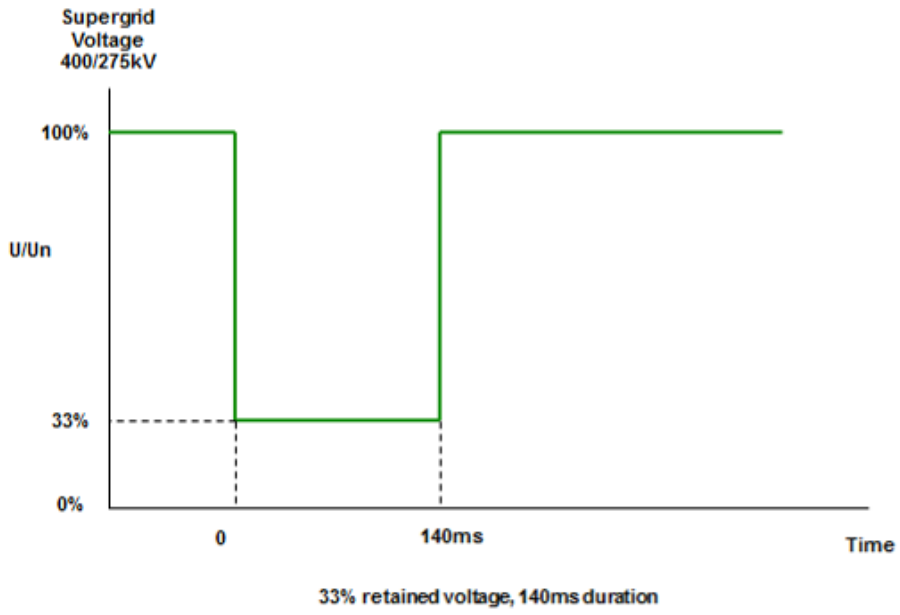

Figure EA.4.3.2 (a)

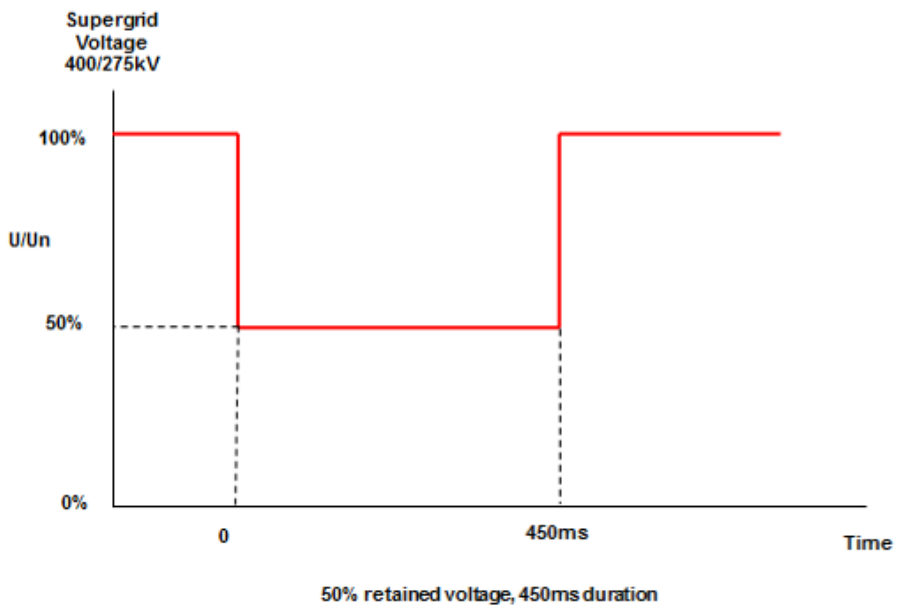

Figure EA.4.3.2 (b)

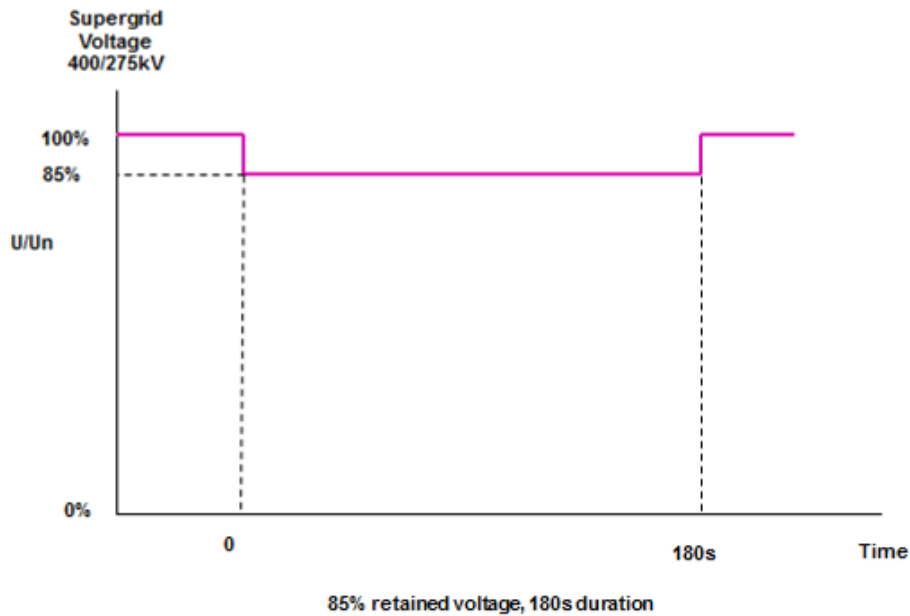

Figure EA.4.3.2 (c)

ECC.A.4A3.2 Requirements applicable to **Power Park Modules** or **OTSDUW Plant and Apparatus** subject to **Supergrid Voltage** dips on the **Onshore Transmission System** greater than 140ms in duration

For balanced **Supergrid Voltage** dips on the **Onshore Transmission System** (which could be at an **Interface Point**) having durations greater than 140ms and up to 3 minutes the **Fault Ride Through** requirement is defined in ECC.6.3.15.9.2.1(b) and Figure ECC.6.3.15.9(b) which is reproduced in this Appendix as Figure EA.4.3.3 and termed the voltage–duration profile.

This profile is not a voltage-time response curve that would be obtained by plotting the transient voltage response at a point on the **Onshore Transmission System** (or **User System** if located **Onshore**) to a disturbance. Rather, each point on the profile (ie the heavy black line) represents a voltage level and an associated time duration which connected **Power Park Modules** or **OTSDUW Plant and Apparatus** must withstand or ride through.

Figures EA.4.3.4 (a), (b) and (c) illustrate the meaning of the voltage-duration profile for voltage dips having durations greater than 140ms.

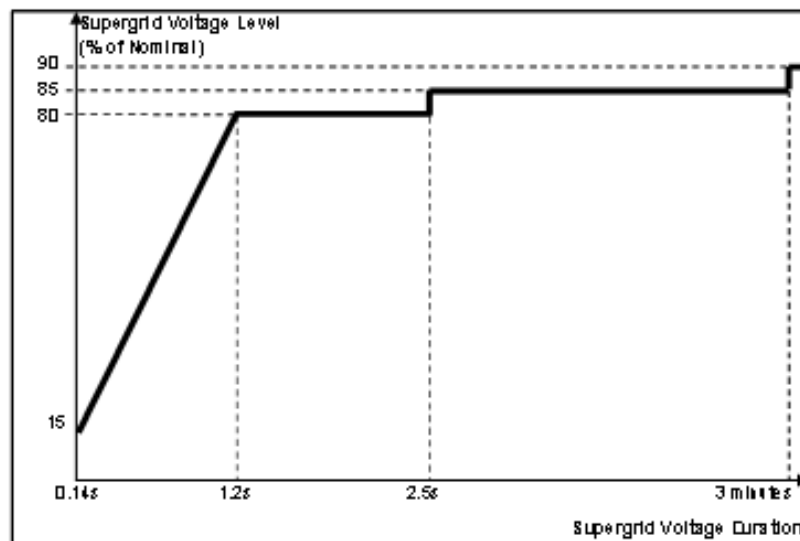
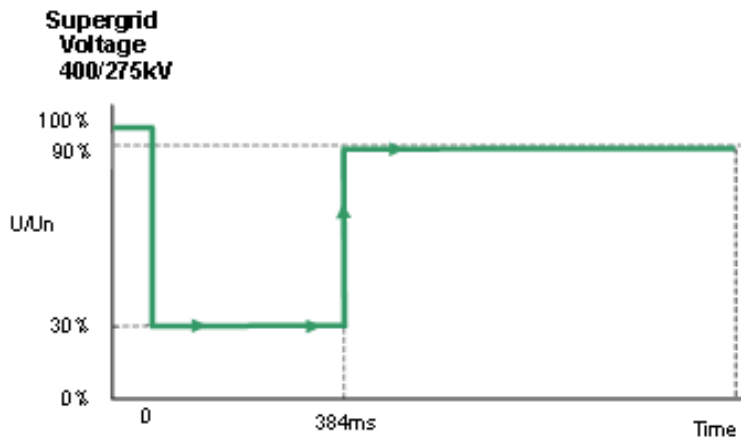
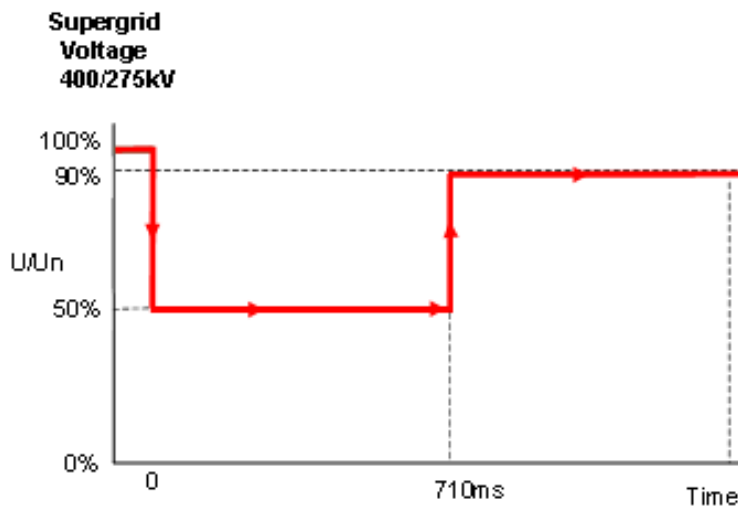

Figure EA.4.3.3



30% retained voltage, 384ms duration

Figure EA.4.3.4(a)



50% retained voltage, 710ms duration

Figure EA.4.3.4 (b)

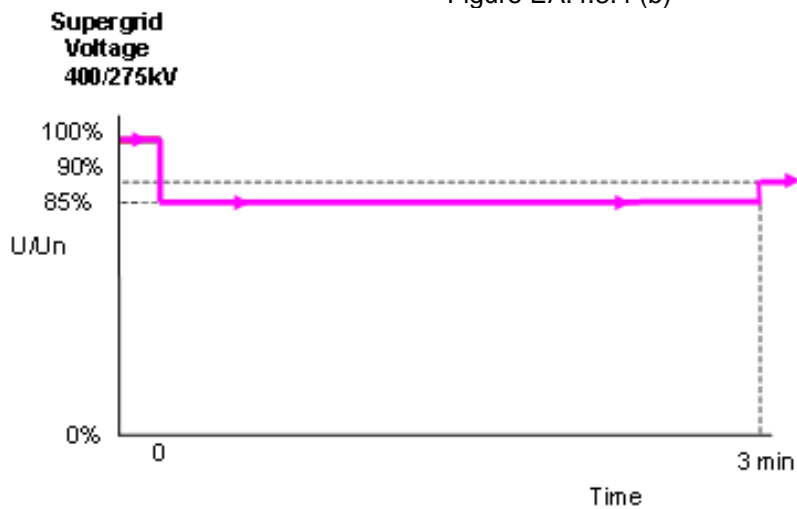

85% retained voltage, 3 minutes duration

Figure EA.4.3.4 (c)

**APPENDIX E5 - TECHNICAL REQUIREMENTS
LOW FREQUENCY RELAYS FOR THE AUTOMATIC
DISCONNECTION OF SUPPLIES AT LOW FREQUENCY**

ECC.A.5.1 Low Frequency Relays

ECC.A.5.1.1 The **Low Frequency Relays** to be used shall have a setting range of 47.0 to 50Hz and be suitable for operation from a nominal AC input of 63.5, 110 or 240V. The following parameters specify the requirements of approved **Low Frequency Relays**:

- (a) **Frequency** settings: 47-50Hz in steps of 0.05Hz or better, preferably 0.01Hz;
- (b) Operating time: Relay operating time shall not be more than 150 ms;
- (c) Voltage lock-out: Selectable within a range of 55 to 90% of nominal voltage;
- (d) Direction: Tripping interlock for forward or reverse power flow capable of being set in either position or off
- (e) Facility stages: One or two stages of **Frequency** operation;
- (f) Output contacts: Two output contacts per stage to be capable of repetitively

making and breaking for 1000 operations:

- (g) Accuracy: 0.01 Hz maximum error under reference environmental and system voltage conditions.
0.05 Hz maximum error at 8% of total harmonic distortion
Electromagnetic Compatibility Level.

In the case of **Network Operators** who are **GB Code Users**, the above requirements only apply to a relay (if any) installed at the **EU Grid Supply Point**. **Network Operators** who are also **GB Code Users** should continue to satisfy the requirements for low frequency relays as specified in the **CCs** as applicable to their **System**.

ECC.A.5.2 Low Frequency Relay Voltage Supplies

ECC.A.5.2.1 It is essential that the voltage supply to the **Low Frequency Relays** shall be derived from the primary **System** at the supply point concerned so that the **Frequency** of the **Low Frequency Relays** input voltage is the same as that of the primary **System**. This requires either:

- (a) the use of a secure supply obtained from voltage transformers directly associated with the grid transformer(s) concerned, the supply being obtained where necessary via a suitable automatic voltage selection scheme; or
- (b) the use of the substation 240V phase-to-neutral selected auxiliary supply, provided that this supply is always derived at the supply point concerned and is never derived from a standby supply **Power Generating Module** or from another part of the **User System**.

ECC.A.5.3 Scheme Requirements

ECC.A.5.3.1 The tripping facility should be engineered in accordance with the following reliability considerations:

(a) Dependability

Failure to trip at any one particular **Demand** shedding point would not harm the overall operation of the scheme. However, many failures would have the effect of reducing the amount of **Demand** under low **Frequency** control. An overall reasonable minimum requirement for the dependability of the **Demand** shedding scheme is 96%, i.e. the average probability of failure of each **Demand** shedding point should be less than 4%. Thus the **Demand** under low **Frequency** control will not be reduced by more than 4% due to relay failure.

(b) Outages

Low **Frequency Demand** shedding schemes will be engineered such that the amount of **Demand** under control is as specified in Table ECC.A.5.5.1a and is not reduced unacceptably during equipment outage or maintenance conditions.

ECC.A.5.3.2 The total operating time of the scheme, including circuit breakers operating time, shall where reasonably practicable, be less than 200 ms. For the avoidance of doubt, the replacement of plant installed prior to October 2009 will not be required in order to achieve lower total scheme operating times.

ECC.A.5.4 Low Frequency Relay Testing

ECC.A.5.4.1 **Low Frequency Relays** installed and commissioned after 1st January 2007 shall be type tested in accordance with and comply with the functional test requirements for **Frequency Protection** contained in Energy Networks Association Technical Specification 48-6-5 Issue 1 dated 2005 "ENA **Protection** Assessment Functional Test Requirements – Voltage and Frequency **Protection**".

For the avoidance of doubt, **Low Frequency Relays** installed and commissioned before 1st January 2007 shall comply with the version of ECC.A.5.1.1 applicable at the time such **Low Frequency Relays** were commissioned.

ECC.A.5.4.2 Each **Non-Embedded Customer** shall aim to execute testing on its low frequency demand disconnection relays installed within its network and in service at least once every three years, although this may be extended to no more than every five years if considered to be required for operational purposes.

ECC.A.5.4.3 Each **Network Operator** and **Relevant Transmission Licensee** shall aim to execute testing on its low frequency demand disconnection relays installed within its network and in service at least once every three years, although this may be extended to no more than every five years if considered to be required for operational purposes.

ECC.A.5.5 Scheme Settings

ECC.A.5.5.1 Table CC.A.5.5.1a shows, for each **Transmission Area**, the percentage of **Demand** (based on **Annual ACS Conditions**) at the time of forecast **National Electricity Transmission System** peak **Demand** that each **Network Operator** whose **System** is connected to the **Onshore Transmission System** within such **Transmission Area** shall disconnect by **Low Frequency Relays** at a range of frequencies. Where a **Network Operator's System** is connected to the **National Electricity Transmission System** in more than one **Transmission Area**, the settings for the **Transmission Area** in which the majority of the **Demand** is connected shall apply.

Frequency Hz	% Demand disconnection for each Network Operator in Transmission Area		
	NGET	SPT	SHETL
48.8	5		
48.75	5		
48.7	10		
48.6	7.5		10
48.5	7.5	10	
48.4	7.5	10	10
48.2	7.5	10	10
48.0	5	10	10
47.8	5		
Total % Demand	60	40	40

Table ECC.A.5.5.1a

Note – the percentages in table ECC.A.5.5.1a are cumulative such that, for example, should the frequency fall to 48.6 Hz in **NGET's Transmission Area**, 27.5% of the total **Demand** connected to the **National Electricity Transmission System** in **NGET's Transmission Area** shall be disconnected by the action of **Low Frequency Relays**.

The percentage **Demand** at each stage shall be allocated as far as reasonably practicable. The cumulative total percentage **Demand** is a minimum.

- ECC.A.5.5.2 In the case of a **Non-Embedded Customer** (who is also an **EU Code User**) the percentage of **Demand** (based on **Annual ACS Conditions**) at the time of forecast **National Electricity Transmission System** peak **Demand** that each **Non-Embedded Customer** whose **System** is connected to the **Onshore Transmission System** which shall be disconnected by **Low Frequency Relays** shall be in accordance with OC6.6 and the **Bilateral Agreement**.
- ECC.A.5.6 Connection and Reconnection
- ECC.A.5.6.1 As defined under OC.6.6 once automatic low **Frequency Demand Disconnection** has taken place, the **Network Operator** on whose **User System** it has occurred, will not reconnect until **The Company** instructs that **Network Operator** to do so in accordance with OC6. The same requirement equally applies to **Non-Embedded Customers**.
- ECC.A.5.6.2 Once **The Company** instructs the **Network Operator** or **Non Embedded Customer** to reconnect to the **National Electricity Transmission System** following operation of the **Low Frequency Demand Disconnection** scheme it shall do so in accordance with the requirements of ECC.6.2.3.10 and OC6.6.
- ECC.A.5.6.3 **Network Operators** or **Non Embedded Customers** shall be capable of being remotely disconnected from the **National Electricity Transmission System** when instructed by **The Company**. Any requirement for the automated disconnection equipment for reconfiguration of the **National Electricity Transmission System** in preparation for block loading and the time required for remote disconnection shall be specified by **The Company** in accordance with the terms of the **Bilateral Agreement**.
- ECC.A.5.6.4 During **System Restoration**, the **Total System** may be operated outside of **Licence Standards** as provided for in OC9.4.3. During such periods, on or after 31 December 2026, **Transmission Licensees** in accordance with the requirements of the **STC**, **Network Operators** and **Non-Embedded Customers** shall have the remote capability to inhibit and restore the operation of their **Low Frequency Relays** upon instruction from **The Company** as provided for in OC9.5.7(a).

APPENDIX E6 - PERFORMANCE REQUIREMENTS FOR CONTINUOUSLY ACTING AUTOMATIC EXCITATION CONTROL SYSTEMS FOR ONSHORE SYNCHRONOUS POWER GENERATING MODULES,

ECC.A.6.1 Scope

ECC.A.6.1.1 This Appendix sets out the performance requirements of continuously acting automatic excitation control systems for **Type C** and **Type D Onshore Synchronous Power Generating Modules** that must be complied with by the **User**. This Appendix does not limit any site specific requirements where in **The Company's** reasonable opinion these facilities are necessary for system reasons.

ECC.A.6.1.2 Where the requirements may vary the likely range of variation is given in this Appendix. It may be necessary to specify values outside this range where **The Company** identifies a system need, and notwithstanding anything to the contrary **The Company** may specify values outside of the ranges provided in this Appendix 6. The most common variations are in the on-load excitation ceiling voltage requirements and the response time required of the **Exciter**. Actual values will be included in the **Bilateral Agreement**.

ECC.A.6.1.3 Should an **EU Generator** anticipate making a change to the excitation control system it shall notify **The Company** under the **Planning Code** (PC.A.1.2(b) and (c)) as soon as the **EU Generator** anticipates making the change. The change may require a revision to the **Bilateral Agreement**.

ECC.A.6.2 Requirements

ECC.A.6.2.1 The **Excitation System** of a **Type C** or **Type D Onshore Synchronous Power Generating Module** shall include an excitation source (**Exciter**), and a continuously acting **Automatic Voltage Regulator (AVR)** and shall meet the following functional specification. **Type D Synchronous Power Generating Modules** are also required to be fitted with a **Power System Stabiliser** in accordance with the requirements of ECC.A.6.2.5.

ECC.A.6.2.3 Steady State Voltage Control

ECC.A.6.2.3.1 An accurate steady state control of the **Onshore Synchronous Power Generating Module** pre-set **Synchronous Generating Unit** terminal voltage is required. As a measure of the accuracy of the steady-state voltage control, the **Automatic Voltage Regulator** shall have static zero frequency gain, sufficient to limit the change in terminal voltage to a drop not exceeding 0.5% of rated terminal voltage, when the output of a **Synchronous Generating Unit** within an **Onshore Synchronous Power Generating Module** is gradually changed from zero to rated MVA output at rated voltage, **Active Power** and **Frequency**.

ECC.A.6.2.4 Transient Voltage Control

ECC.A.6.2.4.1 For a step change from 90% to 100% of the nominal **Onshore Synchronous Generating Unit** terminal voltage, with the **Onshore Synchronous Generating Unit** on open circuit, the **Excitation System** response shall have a damped oscillatory characteristic. For this characteristic, the time for the **Onshore Synchronous Generating Unit** terminal voltage to first reach 100% shall be less than 0.6 seconds. Also, the time to settle within 5% of the voltage change shall be less than 3 seconds.

ECC.A.6.2.4.2 To ensure that adequate synchronising power is maintained, when the **Onshore Power Generating Module** is subjected to a large voltage disturbance, the **Exciter** whose output is varied by the **Automatic Voltage Regulator** shall be capable of providing its achievable upper and lower limit ceiling voltages to the **Onshore Synchronous Generating Unit** field in a time not exceeding that specified in the **Bilateral Agreement**. This will normally be not less than 50 ms and not greater than 300 ms. The achievable upper and lower limit ceiling voltages may be dependent on the voltage disturbance.

ECC.A.6.2.4.3 The **Exciter** shall be capable of attaining an **Excitation System On Load Positive Ceiling Voltage** of not less than a value specified in the **Bilateral Agreement** that will be:

not less than 2 per unit (pu)

normally not greater than 3 pu

exceptionally up to 4 pu

of **Rated Field Voltage** when responding to a sudden drop in voltage of 10 percent or more at the **Onshore Synchronous Generating Unit** terminals. **The Company** may specify a value outside the above limits where **The Company** identifies a system need.

ECC.A.6.2.4.4 If a static type **Exciter** is employed:

- (i) the field voltage should be capable of attaining a negative ceiling level specified in the **Bilateral Agreement** after the removal of the step disturbance of ECC.A.6.2.4.3. The specified value will be 80% of the value specified in ECC.A.6.2.4.3. **The Company** may specify a value outside the above limits where **The Company** identifies a system need.
- (ii) the **Exciter** must be capable of maintaining free firing when the **Onshore Synchronous Generating Unit** terminal voltage is depressed to a level which may be between 20% to 30% of rated terminal voltage
- (iii) the **Exciter** shall be capable of attaining a positive ceiling voltage not less than 80% of the **Excitation System On Load Positive Ceiling Voltage** upon recovery of the **Onshore Synchronous Generating Unit** terminal voltage to 80% of rated terminal voltage following fault clearance. **The Company** may specify a value outside the above limits where **The Company** identifies a system need.
- (iv) the requirement to provide a separate power source for the **Exciter** will be specified if **The Company** identifies a **Transmission System** need.

ECC.A.6.2.5 Power Oscillations Damping Control

ECC.A.6.2.5.1 To allow **Type D Onshore Power Generating Modules** to maintain second and subsequent swing stability and also to ensure an adequate level of low frequency electrical damping power, the **Automatic Voltage Regulator** of each **Onshore Synchronous Generating Unit** within each **Type D Onshore Synchronous Power Generating Module** shall include a **Power System Stabiliser** as a means of supplementary control.

ECC.A.6.2.5.2 Whatever supplementary control signal is employed, it shall be of the type which operates into the **Automatic Voltage Regulator** to cause the field voltage to act in a manner which results in the damping power being improved while maintaining adequate synchronising power.

ECC.A.6.2.5.3 The arrangements for the supplementary control signal shall ensure that the **Power System Stabiliser** output signal relates only to changes in the supplementary control signal and not the steady state level of the signal. For example, if generator electrical power output is chosen as a supplementary control signal then the **Power System Stabiliser** output should relate only to changes in the **Synchronous Generating Unit** electrical power output and not the steady state level of power output. Additionally the **Power System Stabiliser** should not react to mechanical power changes in isolation for example during rapid changes in steady state load or when providing frequency response.

ECC.A.6.2.5.4 The output signal from the **Power System Stabiliser** shall be limited to not more than $\pm 10\%$ of the **Onshore Synchronous Generating Unit** terminal voltage signal at the **Automatic Voltage Regulator** input. The gain of the **Power System Stabiliser** shall be such that an increase in the gain by a factor of 3 shall not cause instability.

ECC.A.6.2.5.5 The **Power System Stabiliser** shall include elements that limit the bandwidth of the output signal. The bandwidth limiting must ensure that the highest frequency of response cannot excite torsional oscillations on other plant connected to the network. A bandwidth of 0-5Hz would be judged to be acceptable for this application.

ECC.A.6.2.5.6 The **EU Generator** in respect of its **Type D Synchronous Power Generating Modules** will agree **Power System Stabiliser** settings with **The Company** prior to the on-load commissioning detailed in BC2.11.2(d). To allow assessment of the performance before on-load commissioning the **EU Generator** will provide to **The Company** a report covering the areas specified in ECP.A.3.2.1.

- ECC.A.6.2.5.7 The **Power System Stabiliser** must be active within the **Excitation System** at all times when **Synchronised** including when the **Under Excitation Limiter** or **Over Excitation Limiter** are active. When operating at low load when **Synchronising** or **De-Synchronising** an **Onshore Synchronous Generating Unit**, within a **Type D Synchronous Power Generating Module**, the **Power System Stabiliser** may be out of service.
- ECC.A.6.2.5.8 Where a **Power System Stabiliser** is fitted to a **Pumped Storage Unit** within a **Type D Synchronous Power Generating Module** it must function when the **Pumped Storage Unit** is in both generating and pumping modes. In addition, where a **Power System Stabiliser** is fitted to an **Electricity Storage Unit** within a **Type D Synchronous Electricity Storage Module**, it must function when the **Synchronous Electricity Storage Unit** is in both importing and exporting modes of operation.
- ECC.A.6.2.6 Overall **Excitation System** Control Characteristics
- ECC.A.6.2.6.1 The overall **Excitation System** shall include elements that limit the bandwidth of the output signal. The bandwidth limiting must be consistent with the speed of response requirements and ensure that the highest frequency of response cannot excite torsional oscillations on other plant connected to the network. A bandwidth of 0-5 Hz will be judged to be acceptable for this application.
- ECC.A.6.2.6.2 The response of the **Automatic Voltage Regulator** combined with the **Power System Stabiliser** shall be demonstrated by injecting similar step signal disturbances into the **Automatic Voltage Regulator** reference as detailed in ECPA.5.2 and ECPA.5.4. The **Automatic Voltage Regulator** shall include a facility to allow step injections into the **Automatic Voltage Regulator** voltage reference, with the **Onshore Type D Power Generating Module** operating at points specified by **The Company** (up to rated MVA output). The damping shall be judged to be adequate if the corresponding **Active Power** response to the disturbances decays within two cycles of oscillation.
- ECC.A.6.2.6.3 A facility to inject a band limited random noise signal into the **Automatic Voltage Regulator** voltage reference shall be provided for demonstrating the frequency domain response of the **Power System Stabiliser**. The tuning of the **Power System Stabiliser** shall be judged to be adequate if the corresponding **Active Power** response shows improved damping with the **Power System Stabiliser** in combination with the **Automatic Voltage Regulator** compared with the **Automatic Voltage Regulator** alone over the frequency range 0.3Hz – 2Hz.
- ECC.A.6.2.7 Under-Excitation Limiters
- ECC.A.6.2.7.1 The security of the power system shall also be safeguarded by means of MVAR **Under Excitation Limiters** fitted to the **Synchronous Power Generating Module Excitation System**. The **Under Excitation Limiter** shall prevent the **Automatic Voltage Regulator** reducing the **Synchronous Generating Unit** excitation to a level which would endanger synchronous stability. The **Under Excitation Limiter** shall operate when the excitation system is providing automatic control. The **Under Excitation Limiter** shall respond to changes in the **Active Power** (MW) the **Reactive Power** (MVAR) and to the square of the **Synchronous Generating Unit** voltage in such a direction that an increase in voltage will permit an increase in leading MVAR. The characteristic of the **Under Excitation Limiter** shall be substantially linear from no-load to the maximum **Active Power** output of the **Onshore Power Generating Module** at any setting and shall be readily adjustable.
- ECC.A.6.2.7.2 The performance of the **Under Excitation Limiter** shall be independent of the rate of change of the **Onshore Synchronous Power Generating Module** load and shall be demonstrated by testing as detailed in ECP.A.5.5. The resulting maximum overshoot in response to a step injection which operates the **Under Excitation Limiter** shall not exceed 4% of the **Onshore Synchronous Generating Unit** rated MVA. The operating point of the **Onshore Synchronous Generating Unit** shall be returned to a steady state value at the limit line and the final settling time shall not be greater than 5 seconds. When the step change in **Automatic Voltage Regulator** reference voltage is reversed, the field voltage should begin to respond without any delay and should not be held down by the **Under Excitation Limiter**. Operation into or out of the preset limit levels shall ensure that any resultant oscillations are damped so that the disturbance is within 0.5% of the **Onshore Synchronous Generating Unit** MVA rating within a period of 5 seconds.

- ECC.A.6.2.7.3 The **EU Generator** shall also make provision to prevent the reduction of the **Onshore Synchronous Generating Unit** excitation to a level which would endanger synchronous stability when the **Excitation System** is under manual control.
- ECC.A.6.2.8 Over-Excitation and Stator Current Limiters
- ECC.A.6.2.8.1 The settings of the **Over-Excitation Limiter** and stator current limiter, shall ensure that the **Onshore Synchronous Generating Unit** excitation is not limited to less than the maximum value that can be achieved whilst ensuring the **Onshore Synchronous Generating Unit** is operating within its design limits. If the **Onshore Synchronous Generating Unit** excitation is reduced following a period of operation at a high level, the rate of reduction shall not exceed that required to remain within any time dependent operating characteristics of the **Onshore Synchronous Power Generating Module**.
- ECC.A.6.2.8.2 The performance of the **Over-Excitation Limiter**, shall be demonstrated by testing as described in ECP.A.5.6. Any operation beyond the **Over-Excitation Limit** shall be controlled by the **Over-Excitation Limiter** or stator current limiter without the operation of any **Protection** that could trip the **Onshore Synchronous Power Generating Module**.
- ECC.A.6.2.8.3 The **EU Generator** shall also make provision to prevent any over-excitation restriction of the **Onshore Synchronous Generating Unit** when the **Excitation System** is under manual control, other than that necessary to ensure the **Onshore Power Generating Module** is operating within its design limits.

APPENDIX E7 - PERFORMANCE REQUIREMENTS FOR CONTINUOUSLY ACTING AUTOMATIC VOLTAGE CONTROL SYSTEMS FOR AC CONNECTED ONSHORE POWER PARK MODULES AND OTSDUW PLANT AND APPARATUS AT THE INTERFACE POINT HVDC SYSTEMS AND REMOTE END HVDC CONVERTER STATIONS

ECC.A.7.1 Scope

ECC.A.7.1.1 This Appendix sets out the performance requirements of continuously acting automatic voltage control systems for **Onshore Power Park Modules, Onshore HVDC Converters Remote End HVDC Converter Stations** and **OTSDUW Plant and Apparatus** at the **Interface Point** that must be complied with by the **User**. This Appendix does not limit any site specific requirements where in **The Company's** reasonable opinion these facilities are necessary for system reasons. The control performance requirements applicable to **Configuration 2 AC Connected Offshore Power Park Modules** and **Configuration 2 DC Connected Power Park Modules** are defined in Appendix E8.

ECC.A.7.1.2 Proposals by **EU Generators** or **HVDC System Owners** to make a change to the voltage control systems are required to be notified to **The Company** under the **Planning Code** (PC.A.1.2(b) and (c)) as soon as the **Generator** or **HVDC System Owner** anticipates making the change. The change may require a revision to the **Bilateral Agreement**.

ECC.A.7.1.3 In the case of a **Remote End HVDC Converter** at a **HVDC Converter Station**, the control performance requirements shall be specified in the **Bilateral Agreement**. These requirements shall be consistent with those specified in ECC.6.3.2.4. In the case where the **Remote End HVDC Converter** is required to ensure the zero transfer of **Reactive Power** at the **HVDC Interface Point** then the requirements shall be specified in the **Bilateral Agreement** which shall be consistent with those requirements specified in ECC.A.8 . In the case where a wider reactive capability has been specified in ECC.6.3.2.4, then the requirements consistent with those specified in ECC.A.7.2 shall apply with any variations being agreed between the **User** and **The Company**.

ECC.A.7.2 Requirements

ECC.A.7.2.1 **The Company** requires that the continuously acting automatic voltage control system for the **Onshore Power Park Module, Onshore HVDC Converter** or **OTSDUW Plant and Apparatus** shall meet the following functional performance specification. If a **Network Operator** has confirmed to **The Company** that its network to which an **Embedded Onshore Power Park Module** or **Onshore HVDC Converter** or **OTSDUW Plant and Apparatus** is connected is restricted such that the full reactive range under the steady state voltage control requirements (ECC.A.7.2.2) cannot be utilised, **The Company** may specify alternative limits to the steady state voltage control range that reflect these restrictions. Where the **Network Operator** subsequently notifies **The Company** that such restriction has been removed, **The Company** may propose a **Modification** to the **Bilateral Agreement** (in accordance with the **CUSC** contract) to remove the alternative limits such that the continuously acting automatic voltage control system meets the following functional performance specification. All other requirements of the voltage control system will remain as in this Appendix.

ECC.A.7.2.2 Steady State Voltage Control

ECC.A.7.2.2.1 The **Onshore Power Park Module, Onshore HVDC Converter** or **OTSDUW Plant and Apparatus** shall provide continuous steady state control of the voltage at the **Onshore Grid Entry Point** (or **Onshore User System Entry Point** if **Embedded**) (or the **Interface Point** in the case of **OTSDUW Plant and Apparatus**) with a **Setpoint Voltage** and **Slope** characteristic as illustrated in Figure ECC.A.7.2.2a.

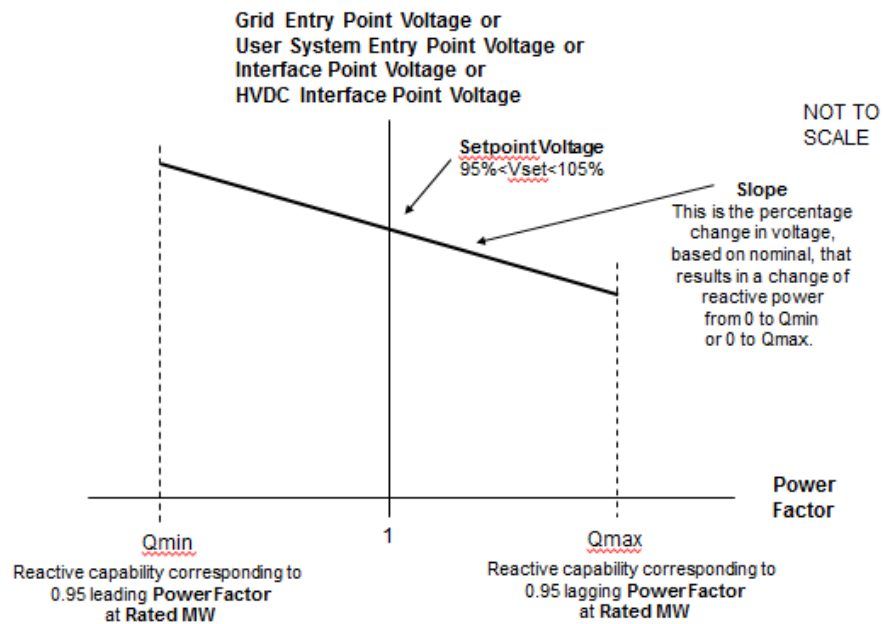

Figure ECC.A.7.2.2a

ECC.A.7.2.2.2 The continuously acting automatic control system shall be capable of operating to a **Setpoint Voltage** between 95% and 105% with a resolution of 0.25% of the nominal voltage. For the avoidance of doubt values of 95%, 95.25%, 95.5% ... may be specified, but not intermediate values. The initial **Setpoint Voltage** will be 100%. The tolerance within which this **Setpoint Voltage** shall be achieved is specified in BC2.A.2.6. For the avoidance of doubt, with a tolerance of 0.25% and a Setpoint Voltage of 100%, the achieved value shall be between 99.75% and 100.25%. **The Company** may request the **EU Generator** or **HVDC System Owner** to implement an alternative **Setpoint Voltage** within the range of 95% to 105%. For **Embedded Generators** and **Embedded HVDC System Owners** the **Setpoint Voltage** will be discussed between **The Company** and the relevant **Network Operator** and will be specified to ensure consistency with ECC.6.3.4.

ECC.A.7.2.2.3 The **Slope** characteristic of the continuously acting automatic control system shall be adjustable over the range 2% to 7% (with a resolution of 0.5%). For the avoidance of doubt values of 2%, 2.5%, 3% may be specified, but not intermediate values. The initial **Slope** setting will be 4%. The tolerance within which this **Slope** shall be achieved is specified in BC2.A.2.6. For the avoidance of doubt, with a tolerance of 0.5% and a **Slope** setting of 4%, the achieved value shall be between 3.5% and 4.5%. **The Company** may request the **EU Generator** or **HVDC System Owner** to implement an alternative slope setting within the range of 2% to 7%. For **Embedded Generators** and **Onshore Embedded HVDC Converter Station Owners** the **Slope** setting will be discussed between **The Company** and the relevant **Network Operator** and will be specified to ensure consistency with ECC.6.3.4.

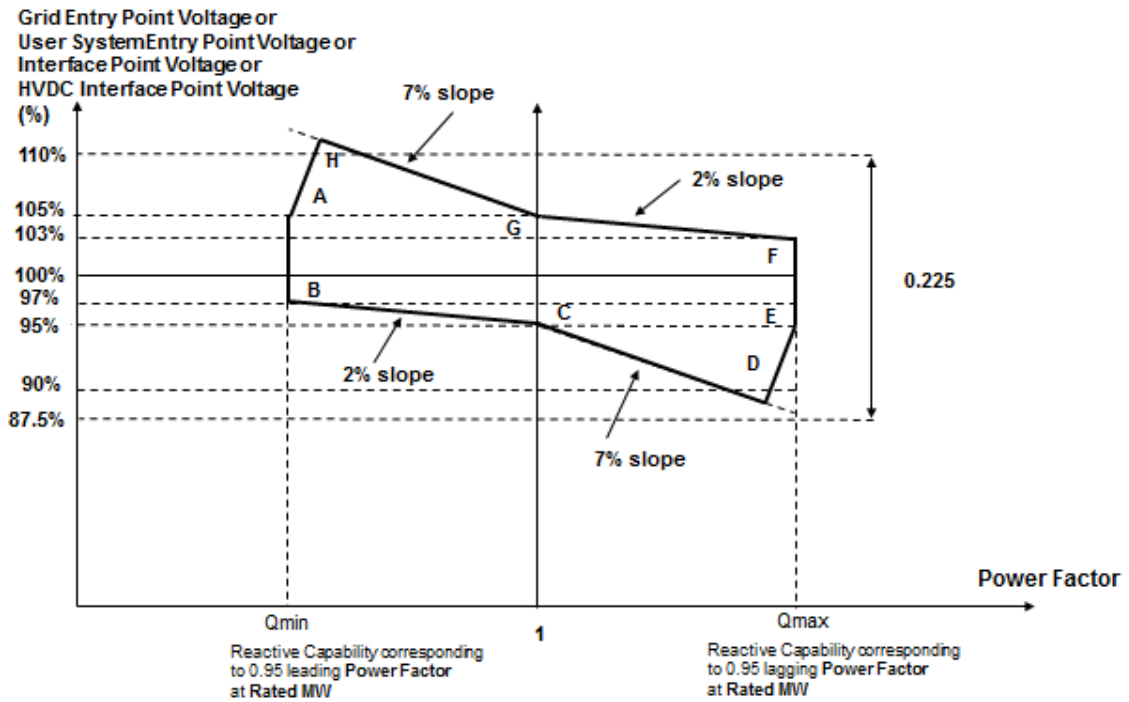

Figure ECC.A.7.2.2b

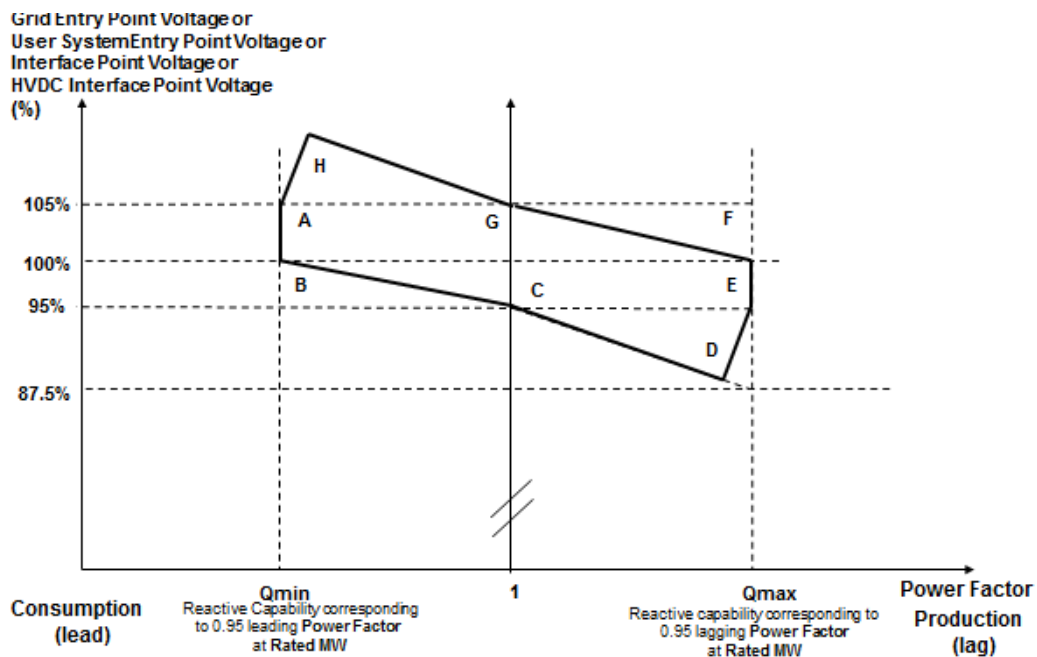

Figure ECC.A.7.2.2c

ECC.A.7.2.2.4 Figure ECC.A.7.2.2b shows the required envelope of operation for -, **OTSDUW Plant and Apparatus, Onshore Power Park Modules and Onshore HVDC Converters** except for those **Embedded** at 33kV and below or directly connected to the **National Electricity Transmission System** at 33kV and below. Figure ECC.A.7.2.2c shows the required envelope of operation for **Onshore Power Park Modules Embedded** at 33kV and below, or directly connected to the **National Electricity Transmission System** at 33kV and below. The enclosed area within points ABCDEFGH is the required capability range within which the **Slope** and **Setpoint Voltage** can be changed.

ECC.A.7.2.2.5 Should the operating point of the, **OTSDUW Plant and Apparatus** or **Onshore Power Park Module**, or **Onshore HVDC Converter** deviate so that it is no longer a point on the operating characteristic (figure ECC.A.7.2.2a) defined by the target **Setpoint Voltage** and **Slope**, the continuously acting automatic voltage control system shall act progressively to return the value to a point on the required characteristic within 5 seconds.

- ECC.A.7.2.2.6 Should the **Reactive Power** output of the **OTSDUW Plant and Apparatus** or **Onshore Power Park Module** or **Onshore HVDC Converter** reach its maximum lagging limit at a **Onshore Grid Entry Point** voltage (or **Onshore User System Entry Point** voltage if **Embedded** (or **Interface Point** in the case of **OTSDUW Plant and Apparatus**) above 95%, the **OTSDUW Plant and Apparatus** or **Onshore Power Park Module** or **HVDC System** shall maintain maximum lagging **Reactive Power** output for voltage reductions down to 95%. This requirement is indicated by the line EF in figures ECC.A.7.2.2b and ECC.A.7.2.2c as applicable. Should the **Reactive Power** output of the **OTSDUW Plant and Apparatus** or **Onshore Power Park Module**, or **Onshore HVDC Converter** reach its maximum leading limit at a **Onshore Grid Entry Point** voltage (or **Onshore User System Entry Point** voltage if **Embedded** or **Interface Point** in the case of **OTSDUW Plant and Apparatus**) below 105%, the **OTSDUW Plant and Apparatus** or **Onshore Power Park Module**, or **Onshore HVDC Converter** shall maintain maximum leading **Reactive Power** output for voltage increases up to 105%. This requirement is indicated by the line AB in figures ECC.A.7.2.2b and ECC.A.7.2.2c as applicable.
- ECC.A.7.2.2.7 For **Onshore Grid Entry Point** voltages (or **Onshore User System Entry Point** voltages if **Embedded** or **Interface Point** voltages) below 95%, the lagging **Reactive Power** capability of the **OTSDUW Plant and Apparatus** or **Onshore Power Park Module** or **Onshore HVDC Converters** should be that which results from the supply of maximum lagging reactive current whilst ensuring the current remains within design operating limits. An example of the capability is shown by the line DE in figures ECC.A.7.2.2b and ECC.A.7.2.2c. For **Onshore Grid Entry Point** voltages (or **User System Entry Point** voltages if **Embedded** or **Interface Point** voltages) above 105%, the leading **Reactive Power** capability of the **OTSDUW Plant and Apparatus** or **Onshore Power Park Module** or **Onshore HVDC System Converter** should be that which results from the supply of maximum leading reactive current whilst ensuring the current remains within design operating limits. An example of the capability is shown by the line AH in figures ECC.A.7.2.2b and ECC.A.7.2.2c as applicable. Should the **Reactive Power** output of the **OTSDUW Plant and Apparatus** or **Onshore Power Park Module** or **Onshore HVDC Converter** reach its maximum lagging limit at an **Onshore Grid Entry Connection Point** voltage (or **Onshore User System Entry Point** voltage if **Embedded** or **Interface Point** in the case of **OTSDUW Plant and Apparatus**) below 95%, the **Onshore Power Park Module**, **Onshore HVDC Converter** shall maintain maximum lagging reactive current output for further voltage decreases. Should the **Reactive Power** output of the **OTSDUW Plant and Apparatus** or **Onshore Power Park Module** or **Onshore HVDC Converter** reach its maximum leading limit at a **Onshore Grid Entry Point** voltage (or **User System Entry Point** voltage if **Embedded** or **Interface Point** voltage in the case of an **OTSDUW Plant and Apparatus**) above 105%, the **OTSDUW Plant and Apparatus** or **Onshore Power Park Module** or **Onshore HVDC Converter** shall maintain maximum leading reactive current output for further voltage increases.
- ECC.A.7.2.2.8 All **OTSDUW Plant and Apparatus** must be capable of enabling **EU Code Users** undertaking **OTSDUW** to comply with an instruction received from **The Company** relating to a variation of the **Setpoint Voltage** at the **Interface Point** within 2 minutes of such instruction being received.
- ECC.A.7.2.2.9 For **OTSDUW Plant and Apparatus** connected to a **Network Operator's System** where the **Network Operator** has confirmed to **The Company** that its **System** is restricted in accordance with ECC.A.7.2.1, clause ECC.A.7.2.2.8 will not apply unless **The Company** can reasonably demonstrate that the magnitude of the available change in **Reactive Power** has a significant effect on voltage levels on the **Onshore National Electricity Transmission System**.
- ECC.A.7.2.3 Transient Voltage Control
- ECC.A.7.2.3.1 For an on-load step change in **Onshore Grid Entry Point** or **Onshore User System Entry Point** voltage, or in the case of **OTSDUW Plant and Apparatus** an on-load step change in **Transmission Interface Point** voltage, the continuously acting automatic control system shall respond according to the following minimum criteria:

- (i) the **Reactive Power** output response of the **OTSDUW Plant and Apparatus** or **Onshore Power Park Module** or **Onshore HVDC Converter** shall commence within 0.2 seconds of the application of the step. It shall progress linearly although variations from a linear characteristic shall be acceptable provided that the MVA_r seconds delivered at any time up to 1 second are at least those that would result from the response shown in figure ECC.A.7.2.3.1a.
- (ii) the response shall be such that 90% of the change in the **Reactive Power** output of the **OTSDUW Plant and Apparatus** or **Onshore Power Park Module**, or **Onshore HVDC Converter** will be achieved within
 - 2 seconds, where the step is sufficiently large to require a change in the steady state **Reactive Power** output from its maximum leading value to its maximum lagging value or vice versa and
 - 1 second where the step is sufficiently large to require a change in the steady state **Reactive Power** output from zero to its maximum leading value or maximum lagging value as required by ECC.6.3.2 (or, if appropriate ECC.A.7.2.2.6 or ECC.A.7.2.2.7);
- (iii) the magnitude of the **Reactive Power** output response produced within 1 second shall vary linearly in proportion to the magnitude of the step change.
- (iv) within 5 seconds from achieving 90% of the response as defined in ECC.A.7.2.3.1 (ii), the peak to peak magnitude of any oscillations shall be less than 5% of the change in steady state maximum **Reactive Power**.
- (v) following the transient response, the conditions of ECC.A.7.2.2 apply.

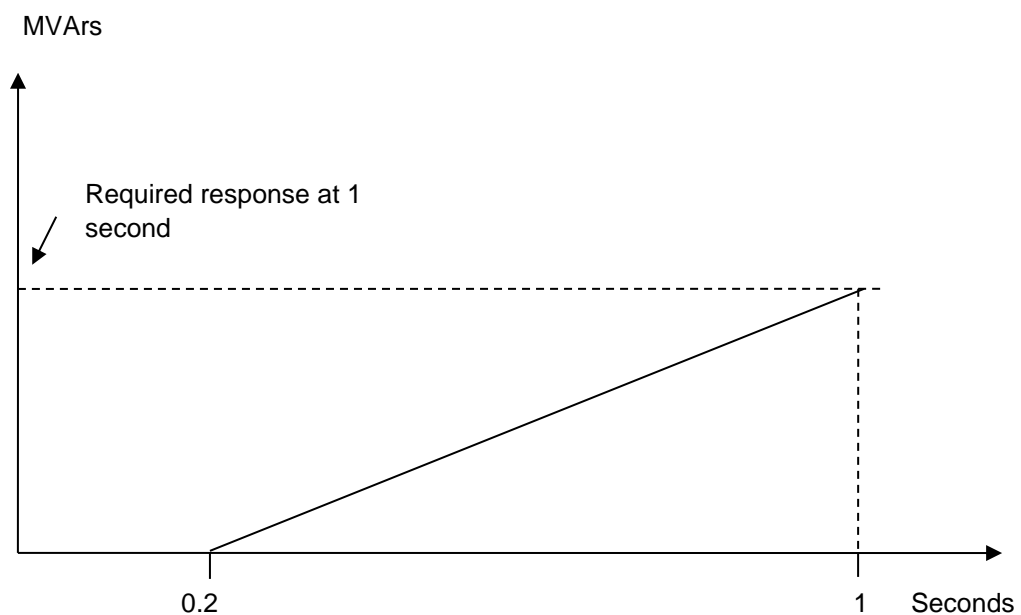

Figure ECC.A.7.2.3.1a

ECC.A.7.2.3.2 OTSDUW Plant and Apparatus or Onshore Power Park Modules or Onshore HVDC Converters shall be capable of

- (a) changing its **Reactive Power** output from its maximum lagging value to its maximum leading value, or vice versa, then reverting back to the initial level of **Reactive Power** output once every 15 seconds for at least 5 times within any 5 minute period; and
- (b) changing its **Reactive Power** output from zero to its maximum leading value then reverting back to zero **Reactive Power** output at least 25 times within any 24 hour period and from zero to its maximum lagging value then reverting back to zero **Reactive**

Power output at least 25 times within any 24 hour period. Any subsequent restriction on reactive capability shall be notified to **The Company** in accordance with BC2.5.3.2, and BC2.6.1.

In all cases, the response shall be in accordance to ECC.A.7.2.3.1 where the change in **Reactive Power** output is in response to an on-load step change in **Onshore Grid Entry Point** or **Onshore User System Entry Point** voltage, or in the case of **OTSDUW Plant and Apparatus** an on-load step change in **Transmission Interface Point** voltage.

ECC.A.7.2.4 Power Oscillation Damping

ECC.A.7.2.4.1 The requirement for the continuously acting voltage control system to be fitted with a **Power System Stabiliser (PSS)** shall be specified if, in **The Company's** view, this is required for system reasons. However if a **Power System Stabiliser** is included in the voltage control system its settings and performance shall be agreed with **The Company** and commissioned in accordance with BC2.11.2. To allow assessment of the performance before on-load commissioning the **Generator** will provide to **The Company** a report covering the areas specified in ECP.A.3.2.2.

ECC.A.7.2.5 Overall Voltage Control System Characteristics

ECC.A.7.2.5.1 The continuously acting automatic voltage control system is required to respond to minor variations, steps, gradual changes or major variations in **Onshore Grid Entry Point** voltage (or **Onshore User System Entry Point** voltage if **Embedded** or **Interface Point** voltage in the case of **OTSDUW Plant and Apparatus**).

ECC.A.7.2.5.2 The overall voltage control system shall include elements that limit the bandwidth of the output signal. The bandwidth limiting must be consistent with the speed of response requirements and ensure that the highest frequency of response cannot excite torsional oscillations on other plant connected to the network. A bandwidth of 0-5Hz would be judged to be acceptable for this application. All other control systems employed within the **OTSDUW Plant and Apparatus** or **Onshore Power Park Module** or **Onshore HVDC Converter** should also meet this requirement

ECC.A.7.2.5.3 The response of the voltage control system (including the **Power System Stabiliser** if employed) shall be demonstrated by testing in accordance with ECP.A.6.

ECC.A.7.3 Reactive Power Control

ECC.A.7.3.1 As defined in ECC.6.3.8.3.4, **Reactive Power** control mode of operation is not required in respect of **Onshore Power Park Modules** or **OTSDUW Plant and Apparatus** or **Onshore HVDC Converters** unless otherwise specified by **The Company** in coordination with the relevant **Network Operator**. However where there is a requirement for **Reactive Power** control mode of operation, the following requirements shall apply.

ECC.A.7.3.2 The **Onshore Power Park Module** or **OTSDUW Plant and Apparatus** or **Onshore HVDC Converter** shall be capable of setting the **Reactive Power** setpoint anywhere in the **Reactive Power** range as specified in ECC.6.3.2.4 with setting steps no greater than 5 MVar or 5% (whichever is smaller) of full **Reactive Power**, controlling the reactive power at the **Grid Entry Point** or **User System Entry Point** if **Embedded** to an accuracy within plus or minus 5MVar or plus or minus 5% (whichever is smaller) of the full **Reactive Power**.

ECC.A.7.3.3 Any additional requirements for **Reactive Power** control mode of operation shall be specified by **The Company** in coordination with the relevant **Network Operator**..

ECC.A.7.4 Power Factor Control

ECC.A.7.4.1 As defined in ECC.6.3.8.4.3, **Power Factor** control mode of operation is not required in respect of **Onshore Power Park Modules** or **OTSDUW Plant and Apparatus** or **Onshore HVDC Converters** unless otherwise specified by **The Company** in coordination with the relevant **Network Operator**. However where there is a requirement for **Power Factor** control

mode of operation, the following requirements shall apply.

- ECC.A.7.4.2 The **Onshore Power Park Module** or **OTSDUW Plant and Apparatus** or **Onshore HVDC Converter** shall be capable of controlling the **Power Factor** at the **Grid Entry Point or User System Entry Point (if Embedded)** within the required **Reactive Power** range as specified in ECC.6.3.2.2.1 and ECC.6.3.2.4 to a specified target **Power Factor**. **The Company** shall specify the target **Power Factor** value (which shall be achieved within 0.01 of the set **Power Factor**), its tolerance and the period of time to achieve the target **Power Factor** following a sudden change of **Active Power** output. The tolerance of the target **Power Factor** shall be expressed through the tolerance of its corresponding **Reactive Power**. This **Reactive Power** tolerance shall be expressed by either an absolute value or by a percentage of the maximum **Reactive Power** of the **Onshore Power Park Module** or **OTSDUW Plant and Apparatus** or **Onshore HVDC Converter**. The details of these requirements being pursuant to the terms of the **Bilateral Agreement**.
- ECC.A.7.4.3 Any additional requirements for **Power Factor** control mode of operation shall be specified by **The Company** in coordination with the relevant **Network Operator**.

APPENDIX E8 - PERFORMANCE REQUIREMENTS FOR CONTINUOUSLY ACTING AUTOMATIC VOLTAGE CONTROL SYSTEMS FOR CONFIGURATION 2 AC CONNECTED OFFSHORE POWER PARK MODULES AND CONFIGURATION 2 DC CONNECTED POWER PARK MODULES

ECC.A.8.1 Scope

ECC.A.8.1.1 This Appendix sets out the performance requirements of continuously acting automatic voltage control systems for **Configuration 2 AC Connected Offshore Power Park Modules** and **Configuration 2 DC Connected Power Park Modules** that must be complied with by the **EU Code User**. This Appendix does not limit any site specific requirements that may be specified where in **The Company's** reasonable opinion these facilities are necessary for system reasons.

ECC.A.8.1.2 These requirements also apply to **Configuration 2 DC Connected Power Park Modules**. In the case of a **Configuration 1 DC Connected Power Park Module** the technical performance requirements shall be specified by **The Company**. Where the **EU Generator** in respect of a **DC Connected Power Park Module** has agreed to a wider reactive capability range as defined under ECC.6.3.2.5 and ECC.6.2.3.6 then the requirements that apply will be specified by **The Company** and which shall reflect the performance requirements detailed in ECC.A.8.2 below but with different parameters such as droop and **Setpoint Voltage**.

ECC.A.8.1.3 Proposals by **EU Generators** to make a change to the voltage control systems are required to be notified to **The Company** under the **Planning Code** (PC.A.1.2(b) and (c)) as soon as the **Generator** anticipates making the change. The change may require a revision to the **Bilateral Agreement**.

ECC.A.8.2 Requirements

ECC.A.8.2.1 **The Company** requires that the continuously acting automatic voltage control system for the **Configuration 2 AC connected Offshore Power Park Module** and **Configuration 2 DC Connected Power Park Module** shall meet the following functional performance specification.

ECC.A.8.2.2 Steady State Voltage Control

ECC.A.8.2.2.1 The **Configuration 2 AC connected Offshore Power Park Module** and **Configuration 2 DC Connected Power Park Module** shall provide continuous steady state control of the voltage at the **Offshore Connection Point** with a **Setpoint Voltage** and **Slope** characteristic as illustrated in Figure ECC.A.8.2.2a.

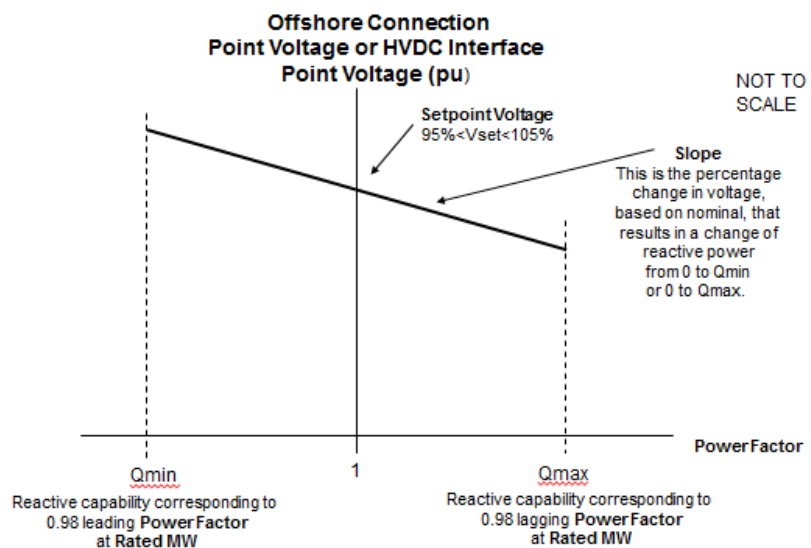

Figure ECC.A.8.2.2a

ECC.A.8.2.2.2 The continuously acting automatic control system shall be capable of operating to a **Setpoint Voltage** between 95% and 105% with a resolution of 0.25% of the nominal voltage. For the avoidance of doubt values of 95%, 95.25%, 95.5% ... may be specified, but not intermediate values. The initial **Setpoint Voltage** will be 100%. The tolerance within which this **Setpoint Voltage** shall be achieved is specified in BC2.A.2.6. For the avoidance of doubt, with a tolerance of 0.25% and a Setpoint Voltage of 100%, the achieved value shall be between 99.75% and 100.25%. **The Company** may request the **EU Generator** to implement an alternative **Setpoint Voltage** within the range of 95% to 105%.

ECC.A.8.2.2.3 The **Slope** characteristic of the continuously acting automatic control system shall be adjustable over the range 2% to 7% (with a resolution of 0.5%). For the avoidance of doubt values of 2%, 2.5%, 3% may be specified, but not intermediate values. The initial **Slope** setting will be 4%. The tolerance within which this **Slope** shall be achieved is specified in BC2.A.2.6. For the avoidance of doubt, with a tolerance of 0.5% and a **Slope** setting of 4%, the achieved value shall be between 3.5% and 4.5%. **The Company** may request the **EU Generator** to implement an alternative slope setting within the range of 2% to 7%.

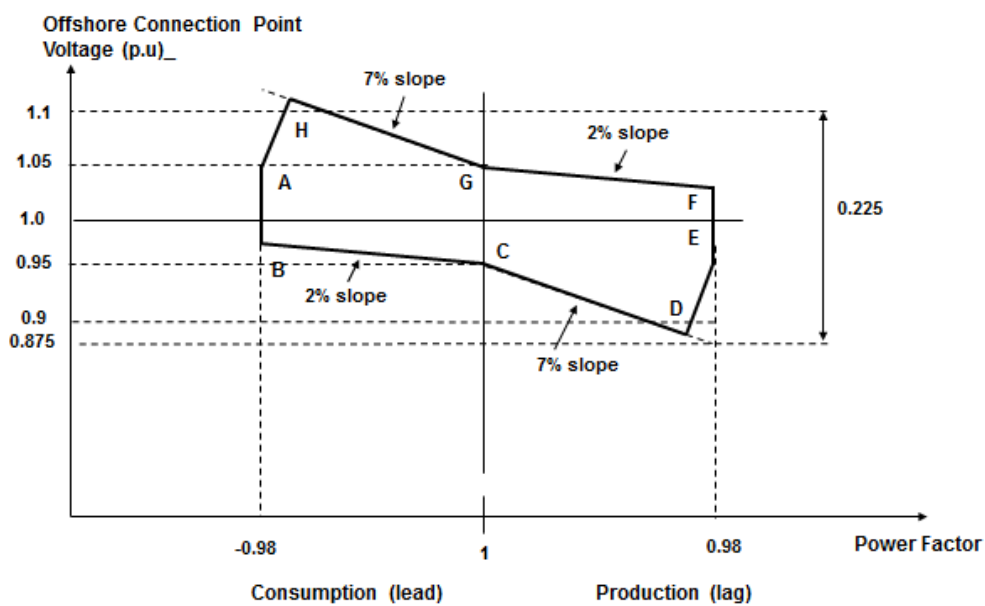

Figure ECC.A.8.2.2b

ECC.A.8.2.2.4 Figure ECC.A.8.2.2b shows the required envelope of operation for **Configuration 2 AC connected Offshore Power Park Module** and **Configuration 2 DC Connected Power Park Module**. The enclosed area within points ABCDEFGH is the required capability range within which the **Slope** and **Setpoint Voltage** can be changed.

ECC.A.8.2.2.5 Should the operating point of the **Configuration 2 AC connected Offshore Power Park or Configuration 2 DC Connected Power Park Module** deviate so that it is no longer a point on the operating characteristic (Figure ECC.A.8.2.2a) defined by the target **Setpoint Voltage** and **Slope**, the continuously acting automatic voltage control system shall act progressively to return the value to a point on the required characteristic within 5 seconds.

ECC.A.8.2.2.6 Should the **Reactive Power** output of the **Configuration 2 AC connected Offshore Power Park Module** or **Configuration 2 DC Connected Power Park Module** reach its maximum lagging limit at an **Offshore Grid Entry Point** or **Offshore User System Entry Point** or **HVDC Interface Point** voltage above 95%, the **Configuration 2 AC connected Offshore Power Park Module** or **Configuration 2 DC Connected Power Park Module** shall maintain maximum lagging **Reactive Power** output for voltage reductions down to 95%. This requirement is indicated by the line EF in figure ECC.A.8.2.2b. Should the **Reactive Power** output of the **Configuration 2 AC connected Offshore Power Park Module** or **Configuration 2 DC Connected Power Park Module** reach its maximum leading limit at the **Offshore Grid Entry Point** or **Offshore User System Entry Point** or **HVDC Interface Point** voltage below 105%, the **Configuration 2 AC connected Offshore Power Park Module** or **Configuration 2 DC Connected Power Park Module** shall maintain maximum leading **Reactive Power** output for voltage increases up to 105%. This requirement is indicated by the line AB in figures ECC.A.8.2.2b.

ECC.A.8.2.2.7 For **Offshore Grid Entry Point** or **User System Entry Point** or **HVDC Interface Point** voltages below 95%, the lagging **Reactive Power** capability of the **Configuration 2 AC connected Offshore Power Park Module** or **Configuration 2 DC Connected Power Park Module** should be that which results from the supply of maximum lagging reactive current whilst ensuring the current remains within design operating limits. An example of the capability is shown by the line DE in figures ECC.A.8.2.2b. For **Offshore Grid Entry Point** or **Offshore User System Entry Point** voltages or **HVDC Interface Point** voltages above 105%, the leading **Reactive Power** capability of the **Configuration 2 AC connected Offshore Power Park Module** or **Configuration 2 DC Connected Power Park Module** should be that which results from the supply of maximum leading reactive current whilst ensuring the current remains within design operating limits. An example of the capability is shown by the line AH in figures ECC.A.8.2.2b. Should the **Reactive Power** output of the **Configuration 2 AC connected Offshore Power Park Module** or **Configuration 2 DC Connected Power Park Module** reach its maximum lagging limit at an **Offshore Grid Entry Point** or **Offshore User System Entry Point** voltage or **HVDC Interface Point** voltage below 95%, the **Configuration 2 AC connected Offshore Power Park Module** or **Configuration 2 DC Connected Power Park Module** shall maintain maximum lagging reactive current output for further voltage decreases. Should the **Reactive Power** output of the **Configuration 2 AC connected Offshore Power Park Module** or **Configuration 2 DC Connected Power Park Module** reach its maximum leading limit at an **Offshore Grid Entry Point** or **Offshore User System Entry Point** voltage or **HVDC Interface Point** voltage above 105%, the **Configuration 2 AC connected Offshore Power Park Module** or **Configuration 2 DC Connected Power Park Module** shall maintain maximum leading reactive current output for further voltage increases.

ECC.A.8.2.3 Transient Voltage Control

ECC.A.8.2.3.1 For an on-load step change in **Offshore Grid Entry Point** or **Offshore User System Entry Point** voltage or **HVDC Interface Point** voltage, the continuously acting automatic control system shall respond according to the following minimum criteria:

- (i) the **Reactive Power** output response of the **Configuration 2 AC connected Offshore Power Park Module** or **Configuration 2 DC Connected Power Park Module** shall commence within 0.2 seconds of the application of the step. It shall progress linearly although variations from a linear characteristic shall be acceptable provided that the MVAR seconds delivered at any time up to 1 second are at least those that would result from the response shown in figure ECC.A.8.2.3.1a.
- (ii) the response shall be such that 90% of the change in the **Reactive Power** output of the **Configuration 2 AC connected Offshore Power Park Module** or **Configuration 2 DC Connected Power Park Module** will be achieved within
 - 2 seconds, where the step is sufficiently large to require a change in the steady state **Reactive Power** output from its maximum leading value to its maximum lagging value or vice versa and
 - 1 second where the step is sufficiently large to require a change in the steady state **Reactive Power** output from zero to its maximum leading value or

maximum lagging value as required by ECC.6.3.2 (or, if appropriate ECC.A.8.2.2.6 or ECC.A.8.2.2.7);

- (iii) the magnitude of the **Reactive Power** output response produced within 1 second shall vary linearly in proportion to the magnitude of the step change.
- (iv) within 5 seconds from achieving 90% of the response as defined in ECC.A.8.2.3.1 (ii), the peak to peak magnitude of any oscillations shall be less than 5% of the change in steady state maximum **Reactive Power**.
- (v) following the transient response, the conditions of ECC.A.8.2.2 apply.

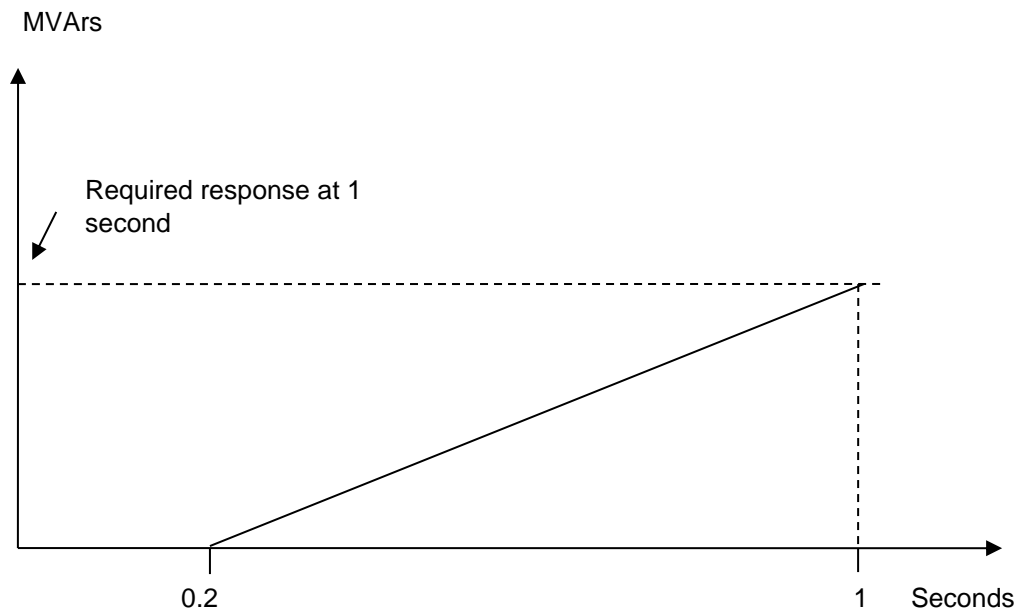

ECC.A.8.2.3.2 Configuration 2 AC connected Offshore Power Park Module or Configuration 2 DC Connected Power Park Module shall be capable of

- (a) changing their **Reactive Power** output from maximum lagging value to maximum leading value, or vice versa, then reverting back to the initial level of **Reactive Power** output once every 15 seconds for at least 5 times within any 5 minute period; and
- (b) changing **Reactive Power** output from zero to maximum leading value then reverting back to zero **Reactive Power** output at least 25 times within any 24 hour period and from zero to its maximum lagging value then reverting back to zero **Reactive Power** output at least 25 times within any 24 hour period. Any subsequent restriction on reactive capability shall be notified to **The Company** in accordance with BC2.5.3.2, and BC2.6.1.

In all cases, the response shall be in accordance to ECC.A.8.2.3.1 where the change in **Reactive Power** output is in response to an on-load step change in **Offshore Grid Entry Point** or **Offshore User System Entry Point** voltage or **HVDC Interface Point** voltage.

ECC.A.8.2.4 Power Oscillation Damping

ECC.A.8.2.4.1 The requirement for the continuously acting voltage control system to be fitted with a **Power System Stabiliser (PSS)** shall be specified if, in **The Company's** view, this is required for system reasons. However if a **Power System Stabiliser** is included in the voltage control system its settings and performance shall be agreed with **The Company** and commissioned in accordance with BC2.11.2. To allow assessment of the performance before on-load commissioning the **Generator** or **HVDC System Owner** will provide to **The Company** a report covering the areas specified in ECP.A.3.2.2.

ECC.A.8.2.5 Overall Voltage Control System Characteristics

ECC.A.8.2.5.1 The continuously acting automatic voltage control system is required to respond to minor variations, steps, gradual changes or major variations in **Offshore Grid Entry Point** or **Offshore User System Entry Point** or **HVDC Interface Point** voltage.

ECC.A.8.2.5.2 The overall voltage control system shall include elements that limit the bandwidth of the output signal. The bandwidth limiting must be consistent with the speed of response requirements and ensure that the highest frequency of response cannot excite torsional oscillations on other plant connected to the network. A bandwidth of 0-5Hz would be judged to be acceptable for this application. All other control systems employed within the **Configuration 2 AC connected Offshore Power Park Module** or **Configuration 2 DC Connected Power Park Module** should also meet this requirement

ECC.A.8.2.5.3 The response of the voltage control system (including the **Power System Stabiliser** if employed) shall be demonstrated by testing in accordance with ECP.A.6.

ECC.A.8.3 Reactive Power Control

ECC.A.8.3.1 **Reactive Power** control mode of operation is not required in respect of **Configuration 2 AC connected Offshore Power Park Modules** or **Configuration 2 DC Connected Power Park Modules** unless otherwise specified by **The Company**. However where there is a requirement for **Reactive Power** control mode of operation, the following requirements shall apply.

ECC.A.8.3.2 **Configuration 2 AC connected Offshore Power Park Modules** or **Configuration 2 DC Connected Power Park Modules** shall be capable of setting the **Reactive Power** setpoint anywhere in the **Reactive Power** range as specified in ECC.6.3.2.8.2 with setting steps no greater than 5 MVar or 5% (whichever is smaller) of full **Reactive Power**, controlling the **Reactive Power** at the **Offshore Grid Entry Point** or **Offshore User System Entry Point** or **HVDC Interface Point** to an accuracy within plus or minus 5MVar or plus or minus 5% (whichever is smaller) of the full **Reactive Power**.

ECC.A.8.3.3 Any additional requirements for **Reactive Power** control mode of operation shall be specified by **The Company**.

ECC.A.8.4 Power Factor Control

ECC.A.8.4.1 **Power Factor** control mode of operation is not required in respect of **Configuration 2 AC connected Offshore Power Park Modules** or **Configuration 2 DC Connected Power Park Modules** unless otherwise specified by **The Company**. However where there is a requirement for **Power Factor** control mode of operation, the following requirements shall apply.

ECC.A.8.4.2 **Configuration 2 AC connected Offshore Power Park Modules** or **Configuration 2 DC Connected Power Park Modules** shall be capable of controlling the **Power Factor** at the **Offshore Grid Entry Point** or **Offshore User System Entry Point** or **HVDC Interface Point** within the required **Reactive Power** range as specified in ECC.6.3.2.8.2 with a target **Power Factor**. **The Company** shall specify the target **Power Factor** (which shall be achieved to within 0.01 of the set **Power Factor**), its tolerance and the period of time to achieve the target **Power Factor** following a sudden change of **Active Power** output. The tolerance of the target **Power Factor** shall be expressed through the tolerance of its corresponding **Reactive Power**.

This **Reactive Power** tolerance shall be expressed by either an absolute value or by a percentage of the maximum **Reactive Power** of the **Configuration 2 AC connected Offshore Power Park Module** or **Configuration 2 DC Connected Power Park Module**. The details of these requirements being specified by **The Company**.

ECC.A.8.4.3 Any additional requirements for **Power Factor** control mode of operation shall be specified by **The Company**.

< END OF EUROPEAN CONNECTION CONDITIONS >