

# **EUROPEAN COMPLIANCE PROCESSES**

(ECP)

## **CONTENTS**

(This contents page does not form part of the Grid Code)

Paragraph No/Title	Page No
ECP.1 INTRODUCTION .....	3
ECP.2 OBJECTIVE .....	4
ECP.3 SCOPE.....	5
ECP.4 CONNECTION PROCESS .....	5
ECP.5 ENERGISATION OPERATIONAL NOTIFICATION .....	7
ECP.6 OPERATIONAL NOTIFICATION PROCESSES .....	7
ECP.6.1 OPERATIONAL NOTIFICATION PROCESS (Type A) .....	7
ECP.6.2 INTERIM OPERATIONAL NOTIFICATION (Type B and Type C).....	9
ECP.6.3 INTERIM OPERATIONAL NOTIFICATION (Type D and HVDC Equipment).....	12
ECP.6.4 INTERIM OPERATIONAL NOTIFICATION (Network Operator's or Non- Embedded Customer's Plant and Apparatus).....	16
ECP.7 FINAL OPERATIONAL NOTIFICATION .....	18
ECP.8 COMPLIANCE REPEAT PLAN .....	21
ECP.9 LIMITED OPERATIONAL NOTIFICATION .....	22
ECP.10 PROCESSES RELATING TO DEROGATIONS.....	27
ECP.11 MANUFACTURER'S DATA & PERFORMANCE REPORT .....	27
APPENDIX 1	29
NOT USED	29
APPENDIX 2	30
USER SELF CERTIFICATION OF COMPLIANCE (Interim/Final) .....	30
APPENDIX 3	31
SIMULATION STUDIES.....	31
APPENDIX 4	47
ONSITE SIGNAL PROVISION FOR WITNESSING TESTS .....	47
APPENDIX 5	54
COMPLIANCE TESTING OF SYNCHRONOUS POWER GENERATING MODULES ..	54
ECP.A.5.2 Excitation System Open Circuit Step Response Tests .....	55
ECP.A.5.3 Open & Short Circuit Saturation Characteristics .....	55
ECP.A.5.6 Over-excitation Limiter Performance Test .....	58
ECP.A.5.8 Governor and Load Controller Response Performance .....	59
ECP.A.5.9 Compliance with ECC.6.3.3 Functionality Test.....	64

ECP

Page 1 of 94

APPENDIX 6	65
COMPLIANCE TESTING OF POWER PARK MODULES .....	65
APPENDIX 7	77
COMPLIANCE TESTING FOR HVDC EQUIPMENT .....	77
APPENDIX 8	87
SIMULATION STUDIES AND COMPLIANCE TESTING FOR NETWORK OPERATORS AND NON-EMBEDDED CUSTOMERS PLANT AND APPARATUS .....	87

## EUROPEAN COMPLIANCE PROCESSES

### ECP.1 INTRODUCTION

ECP.1.1 The **European Compliance Processes** ("ECP") specifies the compliance process in relation to directly connected and **Embedded Power Stations** (subject to a **Bilateral Agreement**), **HVDC Systems**, **Grid Forming Plant** and **Network Operator's** or **Non-Embedded Customer's Plant and Apparatus**. For the avoidance of doubt, the requirements of the **European Compliance Processes** do not apply to **Demand Response Providers** unless they are also an **EU Code User** and have entered into a **CUSC Contract** with **The Company**. **Generators** in respect of **Electricity Storage Modules** are required to meet the requirements of this **ECC** but are not required to satisfy the requirements of **Retained EU Law** (Commission Regulation (EU) 2016/631, Commission Regulation (EU) 2016/1388 or Commission Regulation (EU) 2016/1485). Any derogation in respect of **Electricity Storage Modules** would therefore be against the GB Grid Code as the requirements applicable to **Electricity Storage Modules** are not enforceable by EU Law:

(i) **Type A Power Generating Modules:**

the process for issuing and receiving an **Installation Document** which must be followed by **The Company** and any **User** with a **Type A Power Generating Module** to demonstrate its compliance with the **Grid Code** in relation to its **Plant** and **Apparatus** prior to the relevant **Plant** and **Apparatus** being energised.

(ii) **Type B, Type C or Type D Power Generating Modules and HVDC Systems:**

the process (leading to an **Energisation Operational Notification**) which must be followed by **The Company** and any **User** with a **Type B, Type C or Type D Power Generating Module** or **HVDC System** to demonstrate its compliance with the **Grid Code** in relation to its **Plant** and **Apparatus** (including **OTSUA**) prior to the relevant **Plant** and **Apparatus** (including any **OTSUA**) being energised.

the process (leading to an **Interim Operational Notification** and **Final Operational Notification**) which must be followed by **The Company** and any **User** with a **Type B, Type C or Type D Power Generating Module** or **HVDC System** or **HVDC System Owner** to demonstrate its compliance with the **Grid Code** in relation to its **Plant** and **Apparatus** (including and dynamically controlled **OTSUA**). This process shall be followed prior to and during the course of the relevant **Plant** and **Apparatus** (including **OTSUA**) being energised and **Synchronised**.

the process (leading to a **Limited Operational Notification**) which must be followed by **The Company** and each **User** with a **Type B, Type C or Type D Power Generating Module** or **HVDC System** where any of its **Plant** and/or **Apparatus** (including any **OTSUA**) becomes unable to comply with relevant provisions of the **Grid Code**, and where applicable with Appendices F1 to F5 of the **Bilateral Agreement** (and in the case of **OTSUA** Appendices OF1 to OF5 of the **Bilateral Agreement**). This process also includes when changes or **Modifications** are made to **Plant** and/or **Apparatus** (including **OTSUA**). This process applies to such **Plant** and/or **Apparatus** after the **Plant** and/or **Apparatus** has become **Operational** and until **Disconnected** from the **Total System**, (or until, in the case of

**OTSUA**, the **OTSUA Transfer Time**) when changes or **Modifications** are made.

(iii) **Network Operator's or Non-Embedded Customer's Plant and Apparatus:**

the process (leading to an **Energisation Operational Notification**) which must be followed by **The Company** and any **Network Operator** or **Non-Embedded Customer** to demonstrate its compliance with the **Grid Code** in relation to its **Plant and Apparatus** prior to the relevant **Plant and Apparatus** being energised.

the process (leading to an **Interim Operational Notification** and **Final Operational Notification**) which must be followed by **The Company** and any **Network Operator** or **Non-Embedded Customer** to demonstrate its compliance with the **Grid Code** in relation to its **Plant and Apparatus**. This process shall be followed prior to and during the course of the relevant **Plant and Apparatus** being energised and operated by using the grid connection.

the process (leading to a **Limited Operational Notification**) which must be followed by **The Company** and each **Network Operator** or **Non-Embedded Customer** where any of its **Plant and/or Apparatus** becomes unable to comply with relevant provisions of the **Grid Code**, and where applicable with Appendices F1 to F5 of the **Bilateral Agreement**. This process also includes changes or **Modifications** made to the **Plant and/or Apparatus**. This process applies to such **Plant and/or Apparatus** after the **Plant and/or Apparatus** has become operational and until **Disconnected** from the **Transmission System**.

ECP.1.2 As used in the **ECP**, references to **OTSUA** means **OTSUA** to be connected or connected to the **National Electricity Transmission System** prior to the **OTSUA Transfer Time**.

ECP.1.3 Where a **Generator** or **HVDC System Owner** and/or **The Company** are required to apply for a derogation to the **Authority**, this is not in respect of **OTSUA**.

ECP.1.4 In the case of an **Electricity Storage Plant** comprising of separate generating units and demand taking plant (eg a pump) then compliance would be assessed individually on the generating units and the demand taking elements.

ECP.2 OBJECTIVE

ECP.2.1 The objective of the **ECP** is to ensure that there is a clear and consistent process for demonstration of compliance by **Users** with the **European Connection Conditions** and **Bilateral Agreement** and will enable **The Company** to comply with its statutory and **Transmission Licence** obligations. For the avoidance of doubt, the requirements of the **European Compliance Processes** do not apply to **Demand Response Providers** unless they are also an **EU Code User** and have entered into a **CUSC Contract** with **The Company**.

ECP.2.2 Provisions of the **ECP** which apply in relation to **OTSDUW** and **OTSUA** shall (in any particular case) apply up to the **OTSUA Transfer Time**, whereupon such provisions shall (without prejudice to any prior non-compliance) cease to apply.

ECP.2.3 In relation to **OTSDUW**, provisions otherwise to be contained in a **Bilateral Agreement** may be contained in the **Construction Agreement**, and accordingly a reference in the **ECP** to a relevant **Bilateral Agreement** includes the relevant **Construction Agreement**.

ECP.3 SCOPE

ECP.3.1 The **ECP** applies to **The Company** and to **Users**, which in the **ECP** means:

- (a) **EU Generators** (other than in relation to **Embedded Power Stations** not subject to a **Bilateral Agreement**) including those undertaking **OTSDUW**.
- (b) **Network Operators** who are either;
  - (i) **EU Code Users** in respect of their entire distribution **System**; or
  - (ii) **GB Code Users** in respect of their **EU Grid Supply Points** only
- (c) **Non-Embedded Customers** who are **EU Code Users**;
- (d) **HVDC System Owners** (other than those which only have **Embedded HVDC Systems** not subject to a **Bilateral Agreement**).
- (e) **Grid Forming Plant Owners** who own and operate a **Grid Forming Plant** and intend to satisfy the requirements of ECC.6.3.19

ECP.3.2 The above categories of **User** will become bound by the **ECP** prior to them generating, distributing, supplying or consuming, or in the case of **OTSUA**, transmitting, as the case may be, and references to the various categories should, therefore, be taken as referring to them in that prospective role.

ECP.3.3 For the avoidance of doubt, **Demand Response Providers** do not need to satisfy the requirements of this **ECP** unless they are also defined as an **EU Code User** and have a **CUSC Contract** with **The Company**. Where a **Demand Response Provider** is not an **EU Code User** and does not have a **CUSC Contract** with **The Company**, the requirements of the **Demand Response Services Code** shall only apply.

ECP.3.4 For the avoidance of doubt, this **ECP** does not apply to **GB Code Users** other than in respect of **Network Operator's EU Grid Supply Points**.

ECP.4 CONNECTION PROCESS

ECP.4.1 The **CUSC Contract(s)** contain certain provisions relating to the procedure for connection to the **National Electricity Transmission System** or, in the case of **Embedded Power Stations** or **Embedded HVDC Systems**, becoming operational and include provisions to be complied with by **Users** prior to and during the course of **The Company** notifying the **User** that it has the right to become operational. In addition to such provisions, this **ECP** sets out in further detail the processes to be followed to demonstrate compliance. While this **ECP** does not expressly address the processes to be followed in the case of **OTSUA** connecting to a **Network Operator's User System** prior to **OTSUA Transfer Time**, the processes to be followed by **The Company** and the **Generator** in respect of the **OTSUA** in such circumstances shall be

consistent with those set out below by reference to **OTSUA** directly connected to the **National Electricity Transmission System**.

- ECP.4.2 The provisions contained in ECP.5 to ECP.7 detail the process to be followed in order for the **User's Plant** and **Apparatus** (including **OTSUA**) to become operational. This process includes
- (i) the acceptance of an **Installation Document** for a **Type A Power Generating Module**;
  - (ii) for energisation an **EON** for **Type B, Type C** or **Type D Power Generating Modules**, or **HVDC Equipment, Grid Forming Plant** or **Network Operator's** or **Non-Embedded Customer's Plant and Apparatus**;
  - (iii) for synchronising an **ION** for **Type B, Type C** or **Type D Power Generating Modules** or **HVDC Equipment**;
  - (iv) for operating by using the **Grid Supply Point** an **ION** for;
    - a. **Network Operators** who are **EU Code Users** in respect of their entire distribution **System**;
    - b. **Network Operators** who are **GB Code Users** in respect of their **EU Grid Supply Points** only; or
    - c. **Non-Embedded Customers** who are **EU Code Users**;
  - (v) for final certification a **FON**.
- ECP.4.2.1 The provisions contained in ECP.5 relate to the connection and energisation of **User's Plant** and **Apparatus** (including **OTSUA**) to the **National Electricity Transmission System** or where **Embedded**, to a **User's System**.
- ECP.4.2.2 The provisions contained in ECP.6 and ECP.7 provide the process for **Generators, HVDC System Owners, Grid Forming Plant Owners, Network Operators** and **Non-Embedded Customers** to demonstrate compliance with the **Grid Code** and with, where applicable, the **CUSC Contract(s)** prior to and during the course of such **Generator's, HVDC System Owner's** (including **OTSUA** up to the **OTSUA Transfer Time**), **Network Operator's** and **Non-Embedded Customer's Plant and Apparatus**) becoming operational.
- ECP.4.2.3 The provisions contained in ECP.8 detail the process to be followed to confirm continued compliance (the "Compliance Repeat Plan").
- ECP.4.2.4 The provisions contained in ECP.9 detail the process to be followed when:
- (a) a **Generator's** or **HVDC System Owner's**, or **Grid Forming Plant Owner's**, or **Network Operator's** or **Non-Embedded Customer's Plant** and/or **Apparatus** (including the **OTSUA**) is unable to comply with any provisions of the **Grid Code** and **Bilateral Agreement**; or,
  - (b) following any notification by a **Generator** or a **HVDC System Owner** or a **Grid Forming Plant Owner** or a **Network Operator** or a **Non-Embedded Customer** under the **PC** of any change to its **Plant** and **Apparatus** (including any **OTSUA**); or,
  - (c) a **Modification** to a **Generator's** or a **HVDC System Owner's** or a **Grid Forming Plant Owner's** or a **Network Operator's** or a **Non-Embedded Customer's Plant** and/or **Apparatus**.

- ECP.4.2.4 For **Grid Forming Plant Owners**, the **Operational Notification Process** of this **ECP** shall apply in relation to the type of **Plant** to which the **Grid Forming Capability** is provided (be it a **GBGF-S** or **GBGF-I**),
- ECP.4.3 **Embedded Medium Power Stations** not subject to a **Bilateral Agreement** and **Embedded HVDC Equipment** not subject to a **Bilateral Agreement**
- ECP.4.3.1 In the case of **Embedded Medium Power Stations** not subject to a **Bilateral Agreement** and **Embedded HVDC Systems** not subject to a **Bilateral Agreement**, ensuring the obligations of the **ECC** and Appendix E of the relevant **Bilateral Agreement** between **The Company** and the host **Network Operator** are performed and discharged by the relevant party. For the avoidance of doubt the process in this **ECP** does not apply to **Embedded Medium Power Stations** not subject to a **Bilateral Agreement** and **Embedded HVDC Equipment** not subject to a **Bilateral Agreement**.
- ECP.5 ENERGISATION OPERATIONAL NOTIFICATION
- ECP.5.1 The following provisions apply in relation to the issue of an **Energisation Operational Notification** in respect of a **Power Station** consisting of **Type B, Type C** or **Type D Power Generating Modules** or an **HVDC System** or a **Network Operator's** or a **Non-Embedded Customer's Plant** and **Apparatus**.
- ECP.5.1.1 Certain provisions relating to the connection and energisation of the **User's Plant** and **Apparatus** at the **Connection Site** and **OTSUA** at the **Transmission Interface Point** and in certain cases of **Embedded Plant** and **Apparatus** are specified in the **CUSC** and/or **CUSC Contract(s)**. For other **Embedded Plant** and **Apparatus**, the **Distribution Code**, the **DCUSA** and the **Embedded Development Agreement** for the connection specify equivalent provisions. Further detail on this is set out in ECP.5 below.
- ECP.5.2 The items for submission prior to the issue of an **Energisation Operational Notification** are set out in ECC.5.2.
- ECP.5.3 In the case of a **Generator** or **HVDC System Owner** the items referred to in ECC.5.2 shall be submitted using the **Power Generating Module Document** or **User Data File Structure** as applicable.
- ECP.5.4 Not less than 28 days, or such shorter period as may be acceptable in **The Company's** reasonable opinion, prior to the **User** wishing to energise its **Plant** and **Apparatus** (including passive **OTSUA**) for the first time, the **User** will submit to **The Company** a Certificate of Readiness to Energise **High Voltage** Equipment which specifies the items of **Plant** and **Apparatus** (including **OTSUA**) ready to be energised in a form acceptable to **The Company**.
- ECP.5.5 If the relevant obligations under the provisions of the **CUSC** and/or **CUSC Contract(s)** and the conditions of ECP.5 have been completed to **The Company's** reasonable satisfaction then **The Company** shall issue an **Energisation Operational Notification**. Any dynamically controlled reactive compensation **OTSUA** (including Statcoms or Static Var Compensators) shall not be **Energised** until the appropriate **Interim Operational Notification** has been issued in accordance with ECP.6.
- ECP.6 OPERATIONAL NOTIFICATION PROCESSES
- ECP.6.1 OPERATIONAL NOTIFICATION PROCESS (Type A)

- ECP.6.1.1 The following provisions apply in relation to the notification process in respect of a **Power Station** consisting of **Type A Power Generating Modules**.
- ECP.6.1.2 Not less than 7 days, or such shorter period as may be acceptable in **The Company's** reasonable opinion, prior to the **Generator** wishing to **Synchronise** its **Plant** and **Apparatus** for the first time, the **Generator** will:
- submit to **The Company**, a **Notification of the User's Intention to Connect**; and
  - submit to **The Company** an **Installation Document** containing at least but not limited to the items referred to at ECP.6.1.3.
- ECP.6.1.3 Items for submission prior to connection.
- ECP.6.1.3.1 Prior to the issue of an acknowledgment to connect, the **Generator** must submit to **The Company**, to **The Company's** satisfaction, an **Installation Document** containing at least but not limited to:
- (i) The location at which the connection is made;
  - (ii) The date of the connection;
  - (iii) The **Maximum Capacity** of the installation in kW;
  - (iv) The type of primary energy source;
  - (v) The classification of the **Power Generating Module** as an emerging technology;
  - (vi) A list of references to **Equipment Certificates** issued by an authorised certifier or otherwise agreed with **The Company** used for equipment that is installed at the site or copies of the relevant **Equipment Certificates** issued by an **Authorised Certifier** or otherwise where these are relied upon as part of the evidence of compliance;
  - (vii) As regards equipment used, for which an **Equipment Certificate** has not been received, information shall be provided as directed by **The Company** or the **Relevant Network Operator**; and
  - (viii) The contact details of the **Generator** and the installer and their signatures.
- ECP.6.1.3.2 The items referred to in ECP.6.1.3 shall be submitted by the **Generator** in the form of an **Installation Document** for each applicable **Power Generating Module**.
- ECP.6.1.4 No **Power Generating Module** shall be **Synchronised** to the **Total System** until the later of:
- (a) the date specified by the **Generator** in the **Installation Document** issued in respect of each applicable **Power Generating Module(s)**; and,
  - (b) acknowledgement is received from **The Company** confirming receipt of the **Installation Document**.



- ECP.6.1.5 When the requirements of ECP.6.1.2 to ECP.6.1.4 have been met, **The Company** will notify the **Generator** that the **Power Generating Module** may (subject to the **Generator** having fulfilled the requirements of ECP.6.1.3 where that applies) be **Synchronised** to the **Total System**.
- ECP.6.1.6 Not less than 7 days, or such shorter period as may be acceptable in **The Company's** reasonable opinion, prior to the **Generator** wishing to decommission its **Plant** and **Apparatus**, the **Generator** will submit to **The Company** a **Notification of User's Intention to Disconnect**.
- ECP.6.2 INTERIM OPERATIONAL NOTIFICATION (Type B and Type C)
- ECP.6.2.1 The following provisions apply in relation to the issue of an **Interim Operational Notification** in respect of a **Power Station** consisting of **Type B** and/or **Type C Power Generating Modules**.
- ECP.6.2.2 Not less than 28 days, or such shorter period as may be acceptable in **The Company's** reasonable opinion, prior to the **Generator** wishing to **Synchronise** its **Plant** and **Apparatus** or dynamically controlled **OTSUA** for the first time the **Generator** or **HVDC Equipment** owner will:
- (i) submit to **The Company** a **Notification of User's Intention to Synchronise**; and
  - (ii) submit to **The Company** an initial **Power Generating Module Document** containing at least but not limited to the items referred to at ECP.6.2.3.
- ECP.6.2.3 Items for submission prior to issue of the **Interim Operational Notification**.
- ECP.6.2.3.1 Prior to the issue of an **Interim Operational Notification** in respect of the **EU Code User's Plant** and **Apparatus** or dynamically controlled **OTSUA**, the **Generator** must submit to **The Company** to **The Company's** satisfaction an **Interim Power Generating Module Document** containing at least but not limited to:
- (i) updated **Planning Code** data (both **Standard Planning Data** and **Detailed Planning Data**), with any estimated values assumed for planning purposes confirmed or, where practical, replaced by validated actual values and by updated estimates for the future and by updated forecasts for **Forecast Data** items such as **Demand**;
  - (ii) for **Type C Power Generating Modules** the simulation models;
  - (iii) details of any special **Power Generating Module(s)** protection as required by ECC.6.2.2.3. This may include Pole Slipping protection and islanding protection schemes as applicable;
  - (iv) simulation study provisions of Appendix ECP.A.3 and the results demonstrating compliance with **Grid Code** requirements of:
- PC.A.5.4.2  
PC.A.5.4.3.2,  
ECC.6.3.4,  
ECC.6.3.7.3.1 to ECC.6.3.7.3.6,  
ECC.6.3.15, ECC.6.3.16  
ECC.A.6.2.5.6  
ECC.A.7.2.3.1

as applicable to the **Power Generating Module(s)** or dynamically controlled **OTSUA** unless agreed otherwise by **The Company**;

- (v) a detailed schedule of the tests and the procedures for the tests required to be carried out by the **Generator** under ECP.7.2 to demonstrate compliance with relevant **Grid Code** requirements. Such schedule to be consistent with Appendix ECP.A.5 (in the case of a **Synchronous Power Generating Module**) or Appendix ECP.A.6 (in the case of a **Power Park Modules**) and **OTSUA** as applicable);
- (vi) copies of **Manufacturer's Test Certificates** or **Equipment Certificates** issued by an **Authorised Certifier** or equivalent as agreed with **The Company** where these are relied upon as part of the evidence of compliance; and
- (vii) a **Compliance Statement** and a **User Self Certification of Compliance** completed by the **EU Code User** (including any **Unresolved Issues**) against the relevant **Grid Code** requirements including details of any requirements that the **Generator** has identified that will not or may not be met or demonstrated.

ECP.6.2.3.2 The items referred to in ECP.6.2.3 shall be submitted by the **Generator** in the form of a **Power Generating Module Document (PGMD)** for each applicable **Power Generating Module**.

ECP.6.2.4 No **Generating Unit** or dynamically controlled **OTSUA** shall be **Synchronised** to the **Total System** (and for the avoidance of doubt, dynamically controlled **OTSUA** will not be able to transmit) until the later of:

- (a) the date specified by **The Company** in the **Interim Operational Notification** issued in respect of each applicable **Power Generating Module(s)** or dynamically controlled **OTSUA**; and,
- (b) in the case of **Synchronous Power Generating Module(s)** only after the date of receipt by the **Generator** of written confirmation from **The Company** that the **Synchronous Power Generating Module** or **CCGT Module** as applicable has completed the following tests to demonstrate compliance with the relevant provisions of the **Connection Conditions** to **The Company's** satisfaction:
  - (i) those tests required to establish the open and short circuit saturation characteristics of the **Synchronous Power Generating Module** (as detailed in Appendix ECP.A.4.3) to enable assessment of the short circuit ratio in accordance with ECC.6.3.2. Such tests may be carried out at a location other than the **Power Station** site and supplied in the form of an **Equipment Certificate** or as otherwise agreed by **The Company**; and
  - (ii) open circuit step response tests (as detailed in Appendix ECP.A.5.2) to demonstrate compliance with ECC.A.6.2.4.1.

ECP.6.2.5 **The Company** shall assess the schedule of tests submitted by the **Generator** with the **Notification of User's Intention to Synchronise** under ECP.6.2.3 and shall determine whether such schedule has been completed to **The Company's** satisfaction.

ECP.6.2.6 When the requirements of ECP.6.2.2 to ECP.6.2.5 have been met, **The Company** will notify the **Generator** that the:

**Synchronous Power Generating Module,  
CCGT Module,  
Power Park Module or  
Dynamically controlled OTSUA**

as applicable may (subject to the **Generator** having fulfilled the requirements of ECP.6.2.3 where that applies) be **Synchronised** to the **Total System** through the issue of an **Interim Operational Notification**. Where the **Generator** is undertaking **OTSDUW** then the **Interim Operational Notification** will be in two parts, with the “**Interim Operational Notification Part A**” applicable to **OTSUA** and the **Interim Operational Notification Part B**” applicable to the **EU Code Users Plant and Apparatus**. For the avoidance of doubt, the “**Interim Operational Notification Part A**” and the “**Interim Operational Notification Part B**” can be issued together or at different times. In respect of an **Embedded Power Station** or **Embedded HVDC Equipment Station** (other than an **Embedded Medium Power Stations** not subject to a **Bilateral Agreement** and **Embedded HVDC Equipment Stations** not subject to a **Bilateral Agreement**), **The Company** will notify the **Network Operator** that an **Interim Operational Notification** has been issued.

ECP.6.2.6.1 The **Interim Operational Notification** will be time limited, the expiration date being specified at the time of issue. The **Interim Operational Notification** may be renewed by **The Company**.

ECP.6.2.6.2 The **Generator** must operate the **Power Generating Module** or **OTSUA** in accordance with the terms, arising from the **Unresolved Issues**, of the **Interim Operational Notification**. Where practicable, **The Company** will discuss such terms with the **Generator** prior to including them in the **Interim Operational Notification**.

ECP.6.2.6.3 The **Interim Operational Notification** will include the following limitations:

- (a) In the case of **OTSUA**, the **Interim Operational Notification Part A** permits **Synchronisation** of the dynamically controlled **OTSUA** to the **Total System** only for the purposes of active control of voltage and reactive power and not for the purpose of exporting **Active Power**.
- (b) In the case of a **Power Park Module** the **Interim Operational Notification** (and where **OTSDUW Arrangements** apply, this reference will be to the **Interim Operational Notification Part B**) will limit the proportion of the **Power Park Module** which can be simultaneously **Synchronised** to the **Total System** such that neither of the following figures is exceeded:
  - (i) 20% of the **Maximum Capacity** of the **Power Park Module** (or the output of a single **Power Park Unit** where this exceeds 20% of the **Power Station’s Maximum Capacity**)

until the **Generator** has completed the voltage control tests (detailed in ECP.A.6.2) (including in respect of any dynamically controlled **OTSUA**) to **The Company’s** reasonable satisfaction. Following successful completion of this test each additional **Power Park Unit** should be included in the voltage control scheme as soon as is technically possible (unless **The Company** agrees otherwise).

- (c) In the case of a **Synchronous Power Generating Module** employing a static **Excitation System** the **Interim Operational Notification** (and where **OTSDUW Arrangements** apply, this reference will be to the **Interim Operational Notification Part B**) may, if applicable, limit the

maximum **Active Power** output and **Reactive Power** output of the **Synchronous Power Generating Module** or **CCGT module** prior to the successful commissioning of the **Power System Stabiliser** to **The Company's** satisfaction, if applicable.

ECP.6.2.6.4 Operation in accordance with the **Interim Operational Notification** whilst it is in force will meet the requirements for compliance by the **Generator** and **The Company** of all the relevant provisions of the **European Connection Conditions**.

ECP.6.2.7 Other than **Unresolved Issues** that are subject to tests required under ECP.7.2 to be witnessed by **The Company**, the **Generator** must resolve any **Unresolved Issues** prior to the commencement of the tests, unless **The Company** agrees to a later resolution. The **Generator** must liaise with **The Company** in respect of such resolution. The tests that may be witnessed by **The Company** are specified in ECP.7.2.

ECP.6.2.8 Not less than 28 days, or such shorter period as may be acceptable in **The Company's** reasonable opinion, prior to the **Generator** wishing to commence tests required under ECP.7 to be witnessed by **The Company**, the **Generator** will notify **The Company** that the **Power Generating Module(s)** as applicable is ready to commence such tests.

ECP.6.2.9 The items referred to at ECP.7.3 shall be submitted by the **Generator** after successful completion of the tests required under ECP.7.2.

ECP.6.3 INTERIM OPERATIONAL NOTIFICATION (Type D and HVDC Equipment)

ECP.6.3.1 The following provisions apply in relation to the issue of an **Interim Operational Notification** in respect of a **Power Station** consisting of **Type D Power Generating Modules** or an **HVDC System**.

ECP.6.3.2 Not less than 28 days, or such shorter period as may be acceptable in **The Company's** reasonable opinion, prior to the **Generator** or **HVDC System Owner** wishing to **Synchronise** its **Plant** and **Apparatus** or dynamically controlled **OTSUA** for the first time the **Generator** or **HVDC System Owner** will:

- i. submit to **The Company** a **Notification of User's Intention to Synchronise**; and
- ii. submit to **The Company** the items referred to at ECP.6.3.3.

ECP.6.3.3 Items for submission prior to issue of the **Interim Operational Notification**.

ECP.6.3.3.1 Prior to the issue of an **Interim Operational Notification** in respect of the **EU Code User's Plant** and **Apparatus** or dynamically controlled **OTSUA** the **Generator** or **HVDC System Owner** must submit to **The Company** to **The Company's** satisfaction:

- (a) updated **Planning Code** data (both **Standard Planning Data** and **Detailed Planning Data**), with any estimated values assumed for planning purposes confirmed or, where practical, replaced by validated actual values and by updated estimates for the future and by updated forecasts for **Forecast Data** items such as **Demand**;
- (b) details of any special **Power Generating Module(s)** or **HVDC Equipment** protection as applicable. This may include Pole Slipping protection and islanding protection schemes;

- (c) any items required by ECP.5.2, updated by the **EU Code User** as necessary;
- (d) simulation study provisions of Appendix ECP.A.3 and the results demonstrating compliance with **Grid Code** requirements of:

PC.A.5.4.2  
 PC.A.5.4.3.2,  
 ECC.6.3.4,  
 ECC.6.3.7.3.1 to ECC.6.3.7.3.6,  
 ECC.6.3.15, ECC.6.3.16  
 ECC.A.6.2.5.6  
 ECC.A.7.2.3.1

as applicable to the **Power Station, Synchronous Power Generating Module(s), Power Park Module(s), HVDC Equipment** or dynamically controlled **OTSUA** unless agreed otherwise by **The Company**;

- (e) a detailed schedule of the tests and the procedures for the tests required to be carried out by the **Generator** or **HVDC System Owner** under ECP.7.2 to demonstrate compliance with relevant **Grid Code** requirements. Such schedule to be consistent with Appendix ECP.A.5 (in the case of **Synchronous Power Generating Modules**) or Appendix ECP.A.6 (in the case of **Power Park** Modules and **OTSUA** as applicable) or Appendix ECP.A.7 (in the case of **HVDC Equipment**); and
- (f) an interim **Compliance Statement** and a **User Self Certification of Compliance** completed by the **EU Code User** (including any **Unresolved Issues**) against the relevant **Grid Code** requirements including details of any requirements that the **Generator** or **HVDC System Owner** has identified that will not or may not be met or demonstrated.

ECP.6.3.3.2 The items referred to in ECP.6.3.3 shall be submitted by the **Generator** or **HVDC System Owner** using the **User Data File Structure**.

ECP.6.3.4 No **Power Generating Module** or **HVDC Equipment** shall be **Synchronised** to the **Total System** (and for the avoidance of doubt, dynamically controlled **OTSUA** will not be able to transmit) until the later of:

- (a) the date specified by **The Company** in the **Interim Operational Notification** issued in respect of the **Power Generating Module(s)** or **HVDC Equipment** or dynamically controlled **OTSUA**; and,
- (b) if **Embedded**, the date of receipt of a confirmation from the **Network Operator** in whose **System** the **Plant and Apparatus** is connected that it is acceptable to the **Network Operator** that the **Plant and Apparatus** be connected and **Synchronised**; and,
- (c) in the case of **Synchronous Power Generating Module(s)** only after the date of receipt by **Generator** of written confirmation from **The Company** that the **Synchronous Power Generating Module** has completed the following tests to demonstrate compliance with the relevant provisions of the **Connection Conditions** to **The Company's** satisfaction:

- (i) those tests required to establish the open and short circuit saturation characteristics of the **Synchronous Power Generating Module** (as detailed in Appendix ECP.A.5.3) to enable assessment of the short circuit ratio in accordance with ECC.6.3.2. Such tests may be carried out at a location other than the **Power Station** site; and
- (ii) open circuit step response tests (as detailed in Appendix ECP.A.5.2) to demonstrate compliance with ECC.A.6.2.4.1.

ECP.6.3.5 **The Company** shall assess the schedule of tests submitted by the **Generator** or **HVDC System Owner** with the **Notification of User's Intention to Synchronise** under ECP.6.3.1 and shall determine whether such schedule has been completed to **The Company's** satisfaction.

ECP.6.3.6 When the requirements of ECP.6.3.2 to ECP.6.3.5 have been met, **The Company** will notify the **Generator** or **HVDC System Owner** that the:  
**Synchronous Power Generating Module,**  
**CCGT Module,**  
**Power Park Module**  
Dynamically controlled **OTSUA** or  
**HVDC Equipment,**

as applicable may (subject to the **Generator** or **HVDC System Owner** having fulfilled the requirements of ECP.6.3.3 where that applies) be **Synchronised** to the **Total System** through the issue of an **Interim Operational Notification**. Where the **Generator** is undertaking **OTSDUW** then the **Interim Operational Notification** will be in two parts, with the "**Interim Operational Notification Part A**" applicable to **OTSUA** and the "**Interim Operational Notification Part B**" applicable to the **EU Code Users Plant and Apparatus**. For the avoidance of doubt, the "**Interim Operational Notification Part A**" and the "**Interim Operational Notification Part B**" can be issued together or at different times. In respect of an **Embedded Power Station or Embedded HVDC Equipment Station** (other than **Embedded Medium Power Stations** not subject to a **Bilateral Agreement** and **Embedded HVDC Equipment** not subject to a **Bilateral Agreement**), **The Company** will notify the **Network Operator** that an **Interim Operational Notification** has been issued.

ECP.6.3.6.1 The **Interim Operational Notification** will be time limited, the expiration date being specified at the time of issue. The **Interim Operational Notification** may be renewed by **The Company** for up to a maximum of 24 months from the date of the first issue of the **Interim Operational Notification**. **The Company** may only issue an extension to an **Interim Operational Notification** beyond 24 months provided the **Generator** or **HVDC System Owner** has applied for a derogation for any remaining **Unresolved Issues** to the **Authority** as detailed in ECP.10.

ECP.6.3.6.2 The **Generator** or **HVDC System Owner** must operate the **Power Generating Module** or **HVDC Equipment** in accordance with the terms, arising from the **Unresolved Issues**, of the **Interim Operational Notification**. Where practicable, **The Company** will discuss such terms with the **Generator** or **HVDC System Owner** prior to including them in the **Interim Operational Notification**.

ECP.6.3.6.3 The **Interim Operational Notification** will include the following limitations:

- (a) In the case of **OTSUA**, the **Interim Operational Notification Part A** permits **Synchronisation** of the dynamically controlled **OTSUA** to the

**Total System** only for the purposes of active control of voltage and **Reactive Power** and not for the purpose of exporting **Active Power**.

(b) In the case of a **Power Park Module** the **Interim Operational Notification** (and where **OTSDUW** Arrangements apply, this reference will be to the **Interim Operational Notification Part B**) will limit the proportion of the **Power Park Module** which can be simultaneously **Synchronised** to the **Total System** such that neither of the following figures is exceeded:

(i) 20% of the **Maximum Capacity** of the **Power Park Module** (or the output of a single **Power Park Unit** where this exceeds 20% of the **Power Station's Maximum Capacity**); nor

(ii) 50MW

until the **Generator** has completed the voltage control tests (detailed in ECP.A.6.3.2) to **The Company's** reasonable satisfaction. Following successful completion of this test, each additional **Power Park Unit** should be included in the voltage control scheme as soon as is technically possible (unless **The Company** agrees otherwise).

(c) In the case of a **Power Park Module** with a **Maximum Capacity** greater or equal to 100MW, the **Interim Operational Notification** (and where **OTSDUW** Arrangements apply, this reference will be to the **Interim Operational Notification Part B**) will limit the proportion of the **Power Park Module** which can be simultaneously **Synchronised** to the **Total System** to 70% of **Maximum Capacity** until the **Generator** has completed the **Limited Frequency Sensitive Mode (LFSM-O)** control tests with at least 50% of the **Maximum Capacity** of the **Power Park Module** in service (detailed in ECP.A.6.3.1) to **The Company's** reasonable satisfaction.

(d) In the case of a **Synchronous Power Generating Module** employing a static **Excitation System** or a **Power Park Module** employing a **Power System Stabiliser**, the **Interim Operational Notification** (and where **OTSDUW Arrangements** apply, this reference will be to the **Interim Operational Notification Part B**) may if applicable limit the maximum **Active Power** output and **Reactive Power** output of the **Synchronous Power Generating Module** or **CCGT module** prior to the successful commissioning of the **Power System Stabiliser** to **The Company's** satisfaction.

ECP.6.3.6.4 Operation in accordance with the **Interim Operational Notification** whilst it is in force will meet the requirements for compliance by the **Generator** or **HVDC System Owner** and **The Company** of all the relevant provisions of the **European Connection Conditions**.

ECP.6.3.7 Other than **Unresolved Issues** that are subject to tests required under ECP.7.2 to be witnessed by **The Company**, the **Generator** or **HVDC System Owner** must resolve any **Unresolved Issues** prior to the commencement of the tests, unless **The Company** agrees to a later resolution. The **Generator** or **HVDC System Owner** must liaise with **The Company** in respect of such resolution. The tests that may be witnessed by **The Company** are specified in ECP.7.2.

ECP.6.3.8 Not less than 28 days, or such shorter period as may be acceptable in **The Company's** reasonable opinion, prior to the **Generator** or **HVDC System Owner** wishing to commence tests required under ECP.7 to be witnessed by **The Company**, the **Generator** or **HVDC System Owner** will notify **The**

**Company** that the **Power Generating Module(s)** or **HVDC Equipment(s)** as applicable is ready to commence such tests.

ECP.6.3.9 The items referred to at ECP.7.3 shall be submitted by the **Generator** or the **HVDC System Owner** after successful completion of the tests required under ECP.7.2.

ECP.6.4 INTERIM OPERATIONAL NOTIFICATION (Network Operator's or Non-Embedded Customer's Plant and Apparatus)

ECP.6.4.1 The following provisions apply in relation to the issue of an **Interim Operational Notification** in respect of **Network Operator's** or **Non-Embedded Customer's Plant and Apparatus**.

ECP.6.4.2 Not less than 28 days, or such shorter period as may be acceptable in **The Company's** reasonable opinion, prior to the **Network Operator** or **Non-Embedded Customer** wishing to operate its **Plant and Apparatus** by using the **EU Grid Supply Point** for the first time, the **Network Operator** or **Non-Embedded Customer** will:

- i. submit to **The Company** a **Notification of User's Intention to Operate**; and
- ii. submit to **The Company** the items referred to at ECP.6.4.3.

ECP.6.4.3 Items for submission prior to issue of the **Interim Operational Notification**.

ECP.6.4.3.1 Prior to the issue of an **Interim Operational Notification** in respect of the **User's Plant and Apparatus** at an **EU Grid Supply Point**, the **Network Operator** or **Non-Embedded Customer** must submit to **The Company** to **The Company's** satisfaction:

- (a) updated **Planning Code** data (both **Standard Planning Data** and **Detailed Planning Data**), with any estimated values assumed for planning purposes confirmed or, where practical, replaced by validated actual values and by updated estimates for the future and by updated forecasts for **Forecast Data** items such as **Demand**;
- (b) details of any special protection as applicable;
- (c) any items required by ECP.5.2, updated as necessary;
- (d) data submission and results required by Appendix ECP.A.8 demonstrating compliance with **Grid Code** requirements of:

PC.A.2.2  
PC.A.2.3  
PC.A.2.4  
PC.A.2.5.2  
PC.A.2.5.3  
PC.A.2.5.4  
PC.A.2.5.6  
PC.A.4  
PC.A.6.1.3  
PC.A.6.3  
PC.A.6.7.1

as applicable to the **Network Operator's** or **Non-Embedded Customer's Plant and Apparatus** unless agreed otherwise by **The Company**;



- (e) a detailed schedule of the tests and the procedures for the tests required to be carried out by the **Network Operator** or **Non-Embedded Customer** under ECP.7.8 (or **Equipment Certificates** as relevant) to demonstrate compliance with relevant **Grid Code** requirements. Such schedule is to be consistent with Appendix ECP.A.8.
  - (f) an interim **Compliance Statement** and a **User Self Certification of Compliance** completed by the **User** (including any **Unresolved Issues**) against the relevant **Grid Code** requirements including details of any requirements that the **Network Operator** or **Non-Embedded Customer** has identified that will not or may not be met or demonstrated.
- ECP.6.4.4 No **Network Operator's** or **Non-Embedded Customer's Plant** and **Apparatus** shall be operated by using the **EU Grid Supply Point** until the date specified by **The Company** in the **Interim Operational Notification**.
- ECP.6.4.5 **The Company** shall assess the schedule of tests submitted by the **Network Operator** or **Non-Embedded Customer** with the **Notification of User's Intention to Operate** under ECP.6.4.1 and shall determine whether such schedule has been completed to **The Company's** satisfaction.
- ECP.6.4.6 When the requirements of ECP.6.4.2 to ECP.6.4.5 have been met, **The Company** will notify the **Network Operator** or **Non-Embedded Customer** that the **Plant** and **Apparatus** may (subject to the **Network Operator** or **Non-Embedded Customer** having fulfilled the requirements of ECP.6.4.3 where that applies) be operated by using the **EU Grid Supply Point** through the issue of an **Interim Operational Notification**.
- ECP.6.4.6.1 The **Interim Operational Notification** will be time limited, the expiration date being specified at the time of issue. The **Interim Operational Notification** may be renewed by **The Company** for up to a maximum of 24 months from the date of the first issue of the **Interim Operational Notification**. **The Company** may only issue an extension to an **Interim Operational Notification** beyond 24 months provided the **Network Operator** or **Non-Embedded Customer** has applied for a derogation for any remaining **Unresolved Issues** to the **Authority** as detailed in ECP.10.
- ECP.6.4.6.2 The **Network Operator** or **Non-Embedded Customer** must operate the **Plant** and **Apparatus** in accordance with the terms, arising from the **Unresolved Issues**, of the **Interim Operational Notification**. Where practicable, **The Company** will discuss such terms with the **Network Operator** or **Non-Embedded Customer** prior to including them in the **Interim Operational Notification**.
- ECP.6.4.7 The **Network Operator** or **Non-Embedded Customer** must resolve any **Unresolved Issues** prior to the commencement of the tests, unless **The Company** agrees to a later resolution. The **Network Operator** or **Non-Embedded Customer** must liaise with **The Company** in respect of such resolution.
- ECP.6.4.8 Not less than 28 days, or such shorter period as may be acceptable in **The Company's** reasonable opinion, prior to the **Network Operator** or **Non-Embedded Customer** wishing to commence tests required under ECP.7.8(e) and ECP.A.8 to be witnessed by **The Company** the **Network Operator** or **Non-Embedded Customer** will notify **The Company** that the **Network Operator** or **Non-Embedded Customer** as applicable is ready to commence such tests.

- ECP.7 FINAL OPERATIONAL NOTIFICATION
- Final Operational Notification in respect of Generators and HVDC System Owners
- ECP.7.1 The following provisions apply in relation to the issue of a **Final Operational Notification** in respect of a **Power Station** consisting of **Type B, Type C** and **Type D Power Generating Modules** or an **HVDC System**.
- ECP.7.2 Tests to be carried out prior to issue of the **Final Operational Notification**.
- ECP.7.2.1 Prior to the issue of a **Final Operational Notification** the **Generator** or **HVDC System Owner** must have completed the tests specified in this ECP.7.2.2 to **The Company's** satisfaction to demonstrate compliance with the relevant **Grid Code** provisions.
- ECP.7.2.2 In the case of any **Power Generating Module, OTSUA** (if applicable) or **HVDC Equipment** these tests will reflect the relevant technical requirements and will comprise one or more of the following:
- (a) Reactive capability tests to demonstrate that the **Power Generating Module, OTSUA** (if applicable) or **HVDC Equipment** can meet the requirements of ECC.6.3.2. These may be witnessed by **The Company** on site if there is no metering to **The Company** Control Centre.
  - (b) voltage control system tests to demonstrate that the **Power Generating Module, OTSUA** (if applicable) or **HVDC Equipment** can meet the requirements of ECC.6.3.6.3, ECC.6.3.8 and, in the case of a **Power Park Module, OTSUA** (if applicable) and **HVDC Equipment**, the requirements of ECC.A.7 or ECC.A.8 and, in the case of **Synchronous Power Generating Module** and **CCGT Module**, the requirements of ECC.A.6, and any terms specified in the **Bilateral Agreement** as applicable. These tests may also be used to validate the **Excitation System** model (PC.A.5.3) or voltage control system model (PC.A.5.4) as applicable. These tests may be witnessed by **The Company**.
  - (c) governor or frequency control system tests to demonstrate that the **Power Generating Module, OTSUA** (if applicable) or **HVDC Equipment** can meet the requirements of ECC.6.3.6.2, ECC.6.3.7, where applicable ECC.A.3, and BC.3.7. In the case of a **Type B Power Generating Module** only tests BC3 and BC4 in ECP.A.5.8 Figure 2 or ECP.A.6.6 Figure 2 must be completed. The results will also validate the **Mandatory Service Agreement** required by ECC.8.1. These tests may also be used to validate the governor model (PC.A.5.3) or frequency control system model (PC.A.5.4) as applicable. These tests may be witnessed by **The Company**.
  - (d) fault ride through tests in respect of a **Power Station** with a **Maximum Capacity** of 100MW or greater, comprised of one or more **Power Park Modules**, to demonstrate compliance with ECC.6.3.15, ECC.6.3.16 and ECC.A.4. Where test results from a **Manufacturers Data & Performance Report** as defined in ECP.11 have been accepted this test will not be required.

- (e) any further tests reasonably required by **The Company** and agreed with the **EU Code User** to demonstrate any aspects of compliance with the **Grid Code** and the **CUSC Contracts**.

ECP.7.2.3 **The Company's** preferred range of tests to demonstrate compliance with the **ECCs** are specified in Appendix ECP.A.5 (in the case of **Synchronous Power Generating Modules**) or Appendix ECP.A.6 (in the case of a **Power Park Modules** or **OTSUA** (if applicable)) or Appendix ECP.A.7 (in the case of **HVDC Equipment** and are to be carried out by the **EU Code User** with the results of each test provided to **The Company**. The **EU Code User** may carry out an alternative range of tests if this is agreed with **The Company**. **The Company** may agree a reduced set of tests where there is a relevant **Manufacturers Data & Performance Report** as detailed in ECP.10 or an applicable **Equipment Certificate** has been accepted.

ECP.7.2.4 In the case of **Offshore Power Park Modules** which do not contribute to **Offshore Transmission Licensee Reactive Power** capability as described in ECC.6.3.2.5 or ECC.6.3.2.6 or Voltage Control as described in ECC.6.3.8.5 the tests outlined in ECP.7.2.2 (a) and ECP.7.2.2 (b) are not required. However, the offshore **Reactive Power** transfer tests outlined in ECP.A.5.8 shall be completed in their place.

ECP.7.2.5 Following completion of each of the tests specified in this ECP.7.2, **The Company** will notify the **Generator** or **HVDC System Owner** whether, in the opinion of **The Company**, the results demonstrate compliance with the relevant **Grid Code** conditions. When the **Generator** or **HVDC System Owner** submits test results to **The Company**, the **Generator** or **HVDC System Owner** may request **The Company** to advise when the notification is expected to be provided. **The Company** should not unduly delay the notification.

ECP.7.2.6 The **Generator** or **HVDC System Owner** is responsible for carrying out the tests and retains the responsibility for safety and personnel during the test.

ECP.7.3 Items for submission prior to issue of the **Final Operational Notification**

ECP.7.3.1 Prior to the issue of a **Final Operational Notification** the **Generator** or **HVDC System Owner** must submit to **The Company** to **The Company's** satisfaction:

- (a) updated **Planning Code** data (both **Standard Planning Data** and **Detailed Planning Data**), with validated actual values and updated estimates for the future including **Forecast Data** items such as **Demand**;
- (b) any items required by ECP.5.2 and ECP.6.2.3 or ECP.6.3.3 as applicable, updated by the **EU Code User** as necessary;
- (c) evidence to **The Company's** satisfaction that demonstrates that the controller models and/or parameters (as required under PC.A.5.3.2(c) option 2, PC.A.5.3.2(d) option 2, PC.A.5.4.2, and/or PC.A.5.4.3.2) supplied to **The Company** provide a reasonable representation of the behaviour of the **EU Code User's Plant** and **Apparatus** and **OTSUA** if applicable;
- (d) copies of **Manufacturer's Test Certificates** or **Equipment Certificates** issued by an **Authorised Certifier** or equivalent where these are relied upon as part of the evidence of compliance;

- (e) results from the tests required in accordance with ECP.7.2 carried out by the **Generator** to demonstrate compliance with relevant **Grid Code** requirements including the tests witnessed by **The Company**; and
- (f) the final **Compliance Statement** and a **User Self Certification of Compliance** signed by the **EU Code User** and a statement of any requirements that the **Generator** or **HVDC System Owner** has identified that have not been met together with a copy of the derogation in respect of the same from the **Authority**.

ECP.7.3.2 The items in ECP.7.3 should be submitted by the **Generator** (including in respect of any **OTSUA** if applicable) or **HVDC System Owner** using the **User Data File Structure**.

ECP.7.4 If the requirements of ECP.7.2 and ECP.7.3 have been successfully met, **The Company** will notify the **Generator** or **HVDC System Owner** that compliance with the relevant **Grid Code** provisions has been demonstrated for the **Power Generating Module(s)**, **OTSUA** if applicable or **HVDC Equipment** as applicable through the issue of a **Final Operational Notification**. In respect of an **Embedded Power Station** or **Embedded HVDC Equipment** other than an **Embedded Medium Power Stations** not subject to a **Bilateral Agreement** and **Embedded HVDC Equipment** not subject to a **Bilateral Agreement**, **The Company** will notify the **Network Operator** that a **Final Operational Notification** has been issued, subject to the requirement to confirm continued compliance as per CP.8.2 as part of the Compliance Repeat Plan.

ECP.7.5 If a **Final Operational Notification** cannot be issued because the requirements of ECP.7.2 and ECP.7.3 have not been successfully met prior to the expiry of an **Interim Operational Notification** then the **Generator** or **HVDC System Owner** (where licensed in respect of its activities) and/or **The Company** shall apply to the **Authority** for a derogation. The provisions of ECP.10 shall then apply.

Final Operational Notification in respect of Network Operator's and Non-Embedded Customer's Plant and Apparatus

ECP.7.6 The following provisions apply in relation to the issue of a **Final Operational Notification** in respect of **Network Operators** and **Non-Embedded Customers Plant and Apparatus**.

ECP.7.7 Prior to the issue of a **Final Operational Notification** the **Network Operator** and **Non-Embedded Customer** must have addressed the **Unresolved Issues** to **The Company's** satisfaction to demonstrate compliance with the relevant **Grid Code** provisions.

ECP.7.8 Prior to the issue of a **Final Operational Notification** the **Network Operator** and **Non-Embedded Customer** must submit to **The Company** to **The Company's** satisfaction:

- (a) updated **Planning Code** data (both **Standard Planning Data** and **Detailed Planning Data**), with validated actual values and updated estimates for the future including **Forecast Data** items such as **Demand**;
- (b) any items required by ECP.5.2 and ECP.6.4 updated by the **User** as necessary;

- (c) evidence to **The Company's** reasonable satisfaction that demonstrates that the models and/or parameters as required under PC.A.2.2, PC.A.2.3, PC.A.2.4, PC.A.2.5, PC.A.4 and PC.A.6 (as applicable), supplied to **The Company** provide a reasonable representation of the behaviour of the **User's Plant and Apparatus**;
- (d) copies of **Manufacturer's Test Certificates** or **Equipment Certificates** issued by an **Authorised Certifier** or equivalent where these are relied upon as part of the evidence of compliance;
- (e) results from the tests and simulations required in accordance with ECP.A.8 carried out by the **Network Operator** or **Non-Embedded Customer** to demonstrate compliance with relevant **Grid Code** requirements including any tests witnessed by **The Company**; and
- (f) the final **Compliance Statement** and a **User Self Certification of Compliance** signed by the **User** and a statement of any requirements that the **Network Operator** or **Non-Embedded Customer** has identified that have not been met together with a copy of the derogation in respect of the same from the **Authority**.

ECP.7.9 The items referred to at ECP.7.8 shall be submitted by the **Network Operator** or **Non-Embedded Customer** after successful completion of the tests required under ECP.7.8.

ECP.7.10 If the requirements of ECP.7.8 have been successfully met, **The Company** will notify the **Network Operator** or **Non-Embedded Customer** that compliance with the relevant **Grid Code** provisions has been demonstrated for **Network Operators** or **Non-Embedded Customers Plant and Apparatus** as applicable through the issue of a **Final Operational Notification**.

ECP.7.11 If a **Final Operational Notification** cannot be issued because the requirements of ECP.7.8 have not been successfully met prior to the expiry of an **Interim Operational Notification**, then the **Network Operator** or **Non-Embedded Customer** and/or **The Company** shall apply to the **Authority** for a derogation. The provisions of ECP.10 shall then apply.

ECP.8 COMPLIANCE REPEAT PLAN

ECP.8.1 No later than 4 calendar years and 6 months after the issue of a **Final Operational Notification**, **The Company** will notify the **Generator** or **HVDC System Owner** that confirmation of continued compliance with the requirements of the Grid Code and/or the **Bilateral Agreement**.

ECP.8.2 No later than 5 calendar years after the issue of a **Final Operational Notification**, the **Generator** or **HVDC System Owner** shall confirm that the **Plant** and/or **Apparatus** (including **OTSUA** if applicable) is fully compliant with the requirements of the Grid Code and/or the **Bilateral Agreement**. The confirmation of compliance will include:

- (a) a **Compliance Statement** and a **User Self Certification of Compliance** signed by the **EU Code User** and a statement of any requirements that the **Generator** or **HVDC System Owner** has identified that have not been met together with a copy of the derogation in respect of the same from **The Authority**.

- (b) complete set of relevant **Planning Code** data (both **Standard Planning Data** and **Detailed Planning Data**), with validated actual values and updated estimates for the future including **Forecast Data** items such as **Demand**. Simulation Studies and results from tests detailed in Appendix ECP.A.3 – ECP.A.8 inclusive are not required as part of the Compliance Repeat Plan.

For the avoidance of doubt the **Generator** or **HVDC System Owner** is responsible for ensuring that **Plant** and/or **Apparatus** (including **OTSUA** if applicable) remains compliant with the relevant clauses of the Grid Code and/or the **Bilateral Agreement** and/or connection site conditions notified by **The Company**.

ECP.8.3 If the requirements of ECP.8.2 have been completed to **The Company's** satisfaction, **The Company** will notify the **Generator** or **HVDC System Owner** that compliance with the relevant Grid Code provisions has been demonstrated for the **Power Generating Module(s)**, including **DC Connected Power Park Module(s)** and **OTSUA**, if applicable or **HVDC Equipment** as applicable through the issue of a **Final Operational Notification** subject to Compliance Repeat Plan (ECP.8) no later than 5 years from the date of issue. In respect of an **Embedded Power Station** or **Embedded DC Converter Station** other than **Embedded Medium Power Stations** not subject to a **Bilateral Agreement** and **Embedded HVDC Systems** not subject to a **Bilateral Agreement**, **The Company** will notify the **Network Operator** that a **Final Operational Notification** has been issued.

ECP.8.4 If a **Final Operational Notification** cannot be issued because the requirements of ECP.8.2 have not been successfully met prior to 5 years from the date of issue of the **Final Operational Notification**, then **The Company** will issue the **Generator** or **HVDC System Owner** (where licensed in respect of its activities) a **Limited Operational Notification** with respect to the **Unresolved Issues**. The provisions of ECP.9 shall then apply.

ECP.9 LIMITED OPERATIONAL NOTIFICATION

ECP.9.1 Following the issue of a **Final Operational Notification** for a **Power Station** consisting of **Type B**, **Type C** or **Type D Power Generating Module** or an **HVDC System** or **Network Operators** or **Non-Embedded Customers Plant** and **Apparatus** if:

- (i) the **Generator** or **HVDC System Owner** or **Network Operator** or **Non-Embedded Customer** becomes aware, that its **Plant** and/or **Apparatus'** (including **OTSUA** if applicable) capability to meet any provisions of the **Grid Code**, or where applicable the **Bilateral Agreement** is not fully available then the **Generator** or **HVDC System Owner** or **Network Operator** or **Non-Embedded Customer** shall follow the process in ECP.9.2 to ECP.9.11; or,
- (ii) a **Network Operator** becomes aware, that the capability of **Plant** and/or **Apparatus** belonging to an **Embedded Power Station** or **Embedded HVDC Equipment Station** (other than **Embedded Medium Power Stations** not subject to a **Bilateral Agreement** and **Embedded HVDC Equipment Stations** not subject to a **Bilateral Agreement**) is failing to meet any provisions of the **Grid Code**, or where applicable the **Bilateral Agreement**, then the **Network Operator** shall inform **The Company** and **The Company** shall inform

the **Generator** or **HVDC System Owner** to then follow the process in ECP.9.2 to ECP.9.11; or,

- (iii) **The Company** becomes aware through monitoring as described in OC5.4, that a **Generator** or **HVDC System Owner Plant** and/or **Apparatus** (including **OTSUA** if applicable) capability to meet any provisions of the **Grid Code**, or where applicable the **Bilateral Agreement** is not fully available then **The Company** shall inform the other party. Where **The Company** and the **Generator** or **HVDC System Owner** cannot agree from the monitoring as described in OC5.4 whether the **Plant and/or Apparatus** (including **OTSUA** if applicable) is fully available and/or is compliant with the requirements of the **Grid Code** and where applicable the **Bilateral Agreement**, the parties shall first apply the process in OC5.5.1, before applying the process defined in ECP.9 (**LON**) if applicable. Where the testing instructed in accordance with OC.5.5.1 indicates that the **Plant** and/or **Apparatus** (including **OTSUA** if applicable) is not fully available and/or is not compliant with the requirements of the **Grid Code** and/or the **Bilateral Agreement**, or if the parties so agree, the process in ECP.9.2 to ECP.9.11 shall be followed.
- (iv) **The Company** becomes aware that a **Network Operator's** or **Non-Embedded Customer's Plant** and **Apparatus** capability to meet any provisions of the **Grid Code**, or where applicable the **Bilateral Agreement**, is not fully available then **The Company** shall inform the other party and the process in ECP.9.2 to ECP.9.11 shall be followed.

ECP.9.2 Immediately upon a **Generator, HVDC System Owner, Network Operator** or **Non-Embedded Customer** becoming aware that its **Power Generating Module, OTSUA** (if applicable), **HVDC Equipment** or **Plant** and **Apparatus**, as applicable may be unable to comply with certain provisions of the **Grid Code** or (where applicable) the **Bilateral Agreement**, the **Generator, HVDC System Owner Network Operator** or **Non-Embedded Customer** shall notify **The Company** in writing. Additional details of any operating restrictions or changes in applicable data arising from the potential non-compliance and an indication of the date from when the restrictions will be removed and full compliance demonstrated shall be provided as soon as reasonably practical.

ECP.9.3 If the nature of any unavailability and/or potential non-compliance described in ECP.9.1 causes or can reasonably be expected to cause a material adverse effect on the business or condition of **The Company** or other **Users** or the **National Electricity Transmission System** or any **User Systems**, then **The Company** may, notwithstanding the provisions of this ECP.9, follow the provisions of Paragraph 5.4 of the **CUSC**.

ECP.9.4 Except where the provisions of ECP.9.3 apply, where the restriction notified in ECP.9.2 is not resolved in 28 days, then

- (i) the **Generator** or **HVDC System Owner** with input from and discussion of conclusions with **The Company**, and the **Network Operator** where the **Synchronous Power Generating Module, CCGT Module, Power Park Module** or **Power Station** as applicable is **Embedded**, shall undertake an investigation to attempt to determine the causes of and determine a solution to the non-compliance. Such investigation shall continue for no longer than 56 days. During such investigation, the **Generator** or **HVDC System Owner** shall provide to **The Company** the relevant data which has changed due to the restriction in respect of ECP.7.3.1 as notified to the **Generator** or

**HVDC System Owner** by **The Company** as being required to be provided; or

- (ii) the **Network Operator** or **Non-Embedded Customer** in discussion with **The Company**, shall undertake an investigation to attempt to determine the causes of and a solution to the non-compliance. Such investigation shall continue for no longer than 56 days. During such investigation the **Network Operator** or **Non-Embedded Customer** shall provide to **The Company** the relevant data which has changed due to the restriction in respect of ECP.7.8 as being required to be provided by **The Company**.

ECP.9.5 Issue and Effect of LON

ECP.9.5.1 Following the issue of a **Final Operational Notification**, **The Company** will issue to the **Generator**, **HVDC System Owner**, **Network Operator** or **Non-Embedded Customer** a **Limited Operational Notification** if:

- (a) by the end of the 56 day period referred to at ECP.9.4, the investigation has not resolved the non-compliance to **The Company's** satisfaction; or
- (b) **The Company** is notified by a **Generator**, **HVDC System Owner** (including **OTSUA** if applicable), **Network Operator** or **Non-Embedded Customer** of a **Modification** to its **Plant** and **Apparatus**; or
- (c) **The Company** receives a submission of data, or a statement from a **Generator**, **HVDC System Owner** (including **OTSUA** if applicable), **Network Operator** or **Non-Embedded Customer** indicating a change in **Plant** or **Apparatus** or settings (including but not limited to governor and excitation control systems) that may in **The Company's** reasonable opinion, acting in accordance with **Good Industry Practice** be expected to result in a material change of performance.

In the case of an **Embedded Generator** or **Embedded HVDC System Owner**, **The Company** will issue a copy of the **Limited Operational Notification** to the **Network Operator**.

ECP.9.5.2 The **Limited Operational Notification** will be time limited (in the case of **Type D Power Generating Modules**, **HVDC Systems**, **Network Operator's** or **Non-Embedded Customer's Plant** and **Apparatus** to expire no later than 12 months from the start of the non-compliance or restriction or from reconnection following a change). **The Company** may agree a longer duration in the case of a **Limited Operational Notification** following a **Modification** or whilst the **Authority** is considering the application for a derogation in accordance with ECP.10.1.

ECP.9.5.3 The **Limited Operational Notification** will notify the **Generator**, **HVDC System Owner**, **Network Operator** or **Non-Embedded Customer** of any restrictions on the operation of the **Synchronous Power Generating Module(s)**, **CCGT Module(s)**, **Power Park Module(s)**, **OTSUA** if applicable, **HVDC Equipment** or **Plant** and **Apparatus** and will specify the **Unresolved Issues**. The **Generator**, **HVDC System Owner**, **Network Operator** or **Non-Embedded Customer** must operate in accordance with any notified restrictions and must resolve the **Unresolved Issues**.

ECP.9.5.4 The **User** and **The Company** will be deemed compliant with all the relevant provisions of the **Grid Code** provided operation is in accordance with the **Limited Operational Notification**, whilst it is in force, and that the provisions of and referred to in ECP.9 are complied with.



ECP.9.5.5 The **Unresolved Issues** included in a **Limited Operational Notification** will show the extent that the provisions of ECP.7.2 (testing) and ECP.7.3 (final data submission) or ECP.7.8 (d) - (e) (testing) and ECP.7.8 (a) - (c) (data submission, as applicable, shall apply. In respect of selecting the extent of any tests which may in **The Company's** view reasonably be needed to demonstrate the restored capability and in agreeing the time period in which the tests will be scheduled, **The Company** shall, where reasonably practicable, take account of the **Generator** or **HVDC System Owner's** input to contain its costs associated with the testing.

ECP.9.5.6 In the case of a change or **Modification**, the **Limited Operational Notification** may specify that the affected **Plant** and **Apparatus** (including **OTSUA** if applicable) or associated **Synchronous Power Generating Module(s)** or **Power Park Unit(s)** must not be **Synchronised** or, in the case of **Network Operator's** or **Non-Embedded Customer's Plant** and **Apparatus**, operated until all of the following items, that in **The Company's** reasonable opinion are relevant, have been submitted to **The Company** to **The Company's** satisfaction:

- (a) updated **Planning Code** data (both **Standard Planning Data** and **Detailed Planning Data**);
- (b) details of any relevant special **Power Station**, **Synchronous Power Generating Module(s)**, **Power Park Module(s)**, **OTSUA** (if applicable), **HVDC Equipment Station(s)** or **Network Operator's** or **Non-Embedded Customer's Plant** and **Apparatus** protection as applicable. This may include Pole Slipping protection and islanding protection schemes; and
- (c) simulation study provisions of Appendix ECP.A.3 or Appendix ECP.A.8 as appropriate and the results demonstrating compliance with **Grid Code** requirements relevant to the change or **Modification** as agreed by **The Company**; and
- (d) a detailed schedule of the tests and the procedures for the tests required to be carried out by the **Generator**, **HVDC Equipment Station**, **Network Operator** or **Non-Embedded Customer** to demonstrate compliance with relevant **Grid Code** requirements as agreed by **The Company**. The schedule of tests shall be consistent with Appendix ECP.A.5, Appendix ECP.A.6 or Appendix ECP.A.8 as appropriate; and
- (e) an interim **Compliance Statement** and a **User Self Certification of Compliance** completed by the **User** (including any **Unresolved Issues**) against the relevant **Grid Code** requirements including details of any requirements that the **Generator**, **HVDC System Owner**, **Network Operator** or **Non-Embedded Customer** has identified that will not or may not be met or demonstrated; and
- (f) any other items specified in the **LON**.

ECP.9.5.7 The items referred to in ECP.9.5.6 shall be submitted by the **Generator** (including in respect of any **OTSUA** if applicable) or **HVDC System Owner** using the **User Data File Structure** or **Power Generation Module Document** as applicable.

ECP.9.5.8 In the case of **Synchronous Power Generating Module(s)** only, the **Unresolved Issues** of the **LON** may require that the **Generator** must complete the following tests to **The Company's** satisfaction to demonstrate compliance

with the relevant provisions of the **ECCs** prior to the **Synchronous Power Generating Module** being **Synchronised** to the **Total System**:

- (a) those tests required to establish the open and short circuit saturation characteristics of the **Synchronous Power Generating Module** (as detailed in Appendix ECP.A.5.3) to enable assessment of the short circuit ratio in accordance with ECC.6.3.2.3.4 or ECC.6.3.2.5. Such tests may be carried out at a location other than the **Power Station** site; and
- (b) open circuit step response tests (as detailed in Appendix ECP.A.5.2) to demonstrate compliance with ECC.A.6.2.4.1.

ECP.9.6 In the case of a change or **Modification**, not less than 28 days, or such shorter period as may be acceptable in **The Company's** reasonable opinion:

- (a) prior to the **Generator** or **HVDC System Owner** (including OTSUA if applicable) wishing to **Synchronise** its **Plant** and **Apparatus** for the first time following the change or **Modification**, the **Generator** or **HVDC System Owner** will:
  - (i) submit a **Notification of User's Intention to Synchronise**; and
  - (ii) submit to **The Company** the items referred to at ECP.9.5.6.
- (b) prior to the **Network Operator** or **Non-Embedded Customer** wishing to operate its **Plant** and **Apparatus** for the first time following the change or **Modification**, the **Network Operator** or **Non-Embedded Customer** will:
  - (i) submit a **Notification of User's intention to operate**; and
  - (ii) submit to **The Company** the items referred to at ECP.9.5.6

ECP.9.7 Other than **Unresolved Issues** that are subject to tests to be witnessed by **The Company**, the **Generator**, **HVDC System Owner**, **Network Operator** or **Non-Embedded Customer** must resolve any **Unresolved Issues** prior to the commencement of the tests, unless **The Company** agrees to a later resolution. The **Generator**, **HVDC System Owner**, **Network Operator** or **Non-Embedded Customer** must liaise with **The Company** in respect of such resolution. The tests that may be witnessed by **The Company** are specified in ECP.7.2.2.

ECP.9.8 Not less than 28 days, or such shorter period as may be acceptable in **The Company's** reasonable opinion, prior to the **Generator** or **HVDC System Owner** wishing to commence tests listed as **Unresolved Issues** to be witnessed by **The Company**, the **Generator** or **HVDC System Owner** will notify **The Company** that the **Synchronous Power Generating Module(s)**, **CCGT Module(s)**, **Power Park Module(s)**, **OTSUA** if applicable or **HVDC Equipment** as applicable is ready to commence such tests.

ECP.9.9 The items referred to at ECP.7.3 or ECP.7.8 as applicable and listed as **Unresolved Issues** shall be submitted by the **Generator**, **HVDC System Owner**, **Network Operator** or **Embedded Customer** after successful completion of the tests.

ECP.9.10 Where the **Unresolved Issues** have been resolved a **Final Operational Notification** will be issued to the **User**.

ECP.9.11 If a **Final Operational Notification** has not been issued by **The Company** as referred to at ECP.9.5.2 (or where agreed following a **Modification** by the

expiry time of the LON) then the **Generator, HVDC System Owner, Network Operator or Non-Embedded Customer** (where licensed in respect of its activities) and **The Company** shall apply to the **Authority** for a derogation.

ECP.10 PROCESSES RELATING TO DEROGATIONS

ECP.10.1 Whilst the **Authority** is considering the application for a derogation, the **Interim Operational Notification** or **Limited Operational Notification** will be extended to remain in force until the **Authority** has notified **The Company** and the **Generator, HVDC System Owner, Network Operator or Non-Embedded Customer** of its decision. Where the **Generator or HVDC System Owner** is not licensed, **The Company** may propose any necessary changes to the **Bilateral Agreement** with such unlicensed **Generator or HVDC System Owner**.

ECP.10.2 If the **Authority**:

- (a) grants a derogation in respect of the **Plant and/or Apparatus**, then **The Company** shall issue **Final Operational Notification** once all other **Unresolved Issues** are resolved; or
- (b) decides a derogation is not required in respect of the **Plant and/or Apparatus** then **The Company** will reconsider the relevant **Unresolved Issues** and may issue a **Final Operational Notification** once all other **Unresolved Issues** are resolved; or
- (c) decides not to grant any derogation in respect of the **Plant and/or Apparatus**, then there will be no **Operational Notification** in place and **The Company** and the **User** shall consider its rights pursuant to the **CUSC**.

ECP.10.3 Where an **Interim Operational Notification** or **Limited Operational Notification** is so conditional upon a derogation and such derogation includes any conditions (including any time limit to such derogation) the **Generator, HVDC System Owner, Network Operator or Non-Embedded Customer** will progress the resolution of any **Unresolved Issues** and / or progress and / or comply with any conditions upon such derogation and the provisions of ECP.6 to ECP.7.11 shall apply and shall be followed.

ECP.11 MANUFACTURER'S DATA & PERFORMANCE REPORT

ECP.11.1.1 Data and performance characteristics in respect of certain **Grid Code** requirements may be registered with **The Company** by **Power Park Unit** manufacturers in respect of specific models of **Power Park Units** by submitting information in the form of a **Manufacturer's Data and Performance Report** to **The Company**.

ECP.11.1.2 A **Generator** planning to construct a new **Power Station** containing the appropriate version of **Power Park Units** in respect of which a **Manufacturer's Data & Performance Report** has been submitted to **The Company** may reference the **Manufacturer's Data & Performance Report** in its submissions to **The Company**. Any **Generator** considering referring to a **Manufacturer's Data & Performance Report** for any aspect of its **Plant and Apparatus** may contact **The Company** to discuss the suitability of the relevant **Manufacturer's Data & Performance Report** to its project to determine if, and to what extent, the data included in the **Manufacturer's Data & Performance Report** contributes towards demonstrating compliance with those aspects of the **Grid Code** applicable to the **Generator**. **The Company** will inform the **Generator** if the reference to the **Manufacturer's Data & Performance Report** is not appropriate or not sufficient for its project.

- ECP.11.1.3 The process to be followed by **Power Park Unit** manufacturers submitting a **Manufacturer's Data & Performance Report** is agreed by **The Company**. ECP.11.2 indicates the specific **Grid Code** requirement areas in respect of which a **Manufacturer's Data & Performance Report** may be submitted.
- ECP.11.1.4 **The Company** will maintain and publish a register of those **Manufacturer's Data & Performance Reports** which **The Company** has received and accepted as being an accurate representation of the performance of the relevant **Plant** and / or **Apparatus**. Such register will identify the manufacturer, the model(s) of **Power Park Unit(s)** to which the report applies and the provisions of the **Grid Code** in respect of which the report contributes towards the demonstration of compliance. The inclusion of any report in the register does not in any way confirm that any **Power Park Modules** which utilise any **Power Park Unit(s)** covered by a report is or will be compliant with the **Grid Code**.
- ECP.11.2 A **Manufacturer's Data & Performance Report** in respect of **Power Park Units** may cover one (or part of one) or more of the following provisions of the **Grid Code**:
- (a) Fault Ride Through capability ECC.6.3.15, ECC.6.3.16.
  - (b) Power Park Module mathematical model PC.A.5.4.2.
- ECP.11.3 Reference to a **Manufacturer's Data & Performance Report** in a **EU Code User's** submissions does not by itself constitute compliance with the **Grid Code**.
- ECP.11.4 A **Generator** referencing a **Manufacturer's Data & Performance Report** should insert the relevant **Manufacturer's Data & Performance Report** reference in the appropriate place in the **DRC** data submission, **Power Generating Module Document** and / or in the **User Data File Structure**. **The Company** will consider the suitability of a **Manufacturer's Data & Performance Report**:
- (a) in place of **DRC** data submissions, a mathematical model suitable for representation of the entire **Power Park Module** as per ECP.A.3.4.4. For the avoidance of doubt only the relevant sections as specified in PC.A.2.5.5.7 apply. Site specific parameters will still need to be submitted by the **Generator**.
  - (b) Not Used.
  - (c) to reduce the scope of compliance site tests as follows;
    - (i) Where there is a **Manufacturer's Data & Performance Report** in respect of a **Power Park Unit** which covers Fault Ride Through, **The Company** may agree that no Fault Ride Through testing is required.
- ECP.11.5 It is the responsibility of the **EU Code User** to ensure that the correct reference for the **Manufacturer's Data & Performance Report** is used and the **EU Code User** by using that reference accepts responsibility for the accuracy of the information. The **EU Code User** shall ensure that the manufacturer has kept **The Company** informed of any relevant variations in plant specification since the submission of the relevant **Manufacturer's Data & Performance Report** which could impact on the validity of the information.

ECP.11.6 **The Company** may contact the **Power Park Unit** manufacturer directly to verify the relevance of the use of such **Manufacturer's Data & Performance Report**. If **The Company** believe the use some or all of such **Manufacturer's Data & Performance Report** information is incorrect or the referenced data is inappropriate, then the reference to the **Manufacturer's Data & Performance Report** may be declared invalid by **The Company**. Where, and to the extent possible, the data included in the **Manufacturer's Data & Performance Report** is appropriate, the compliance assessment process will be continued using the data included in the **Manufacturer's Data & Performance Report**.

ECP.11.7 In the case of a co-located site, for example **Electricity Storage Modules** or **Grid Forming Plant** connected within a new or existing **Power Station**, **The Company** will accept demonstration of compliance at the **Grid Entry Point** or **User System Entry Point** (if **Embedded**) through a combination of the capabilities of the **Power Generating Modules** and **Electricity Storage Modules** (which could include **Grid Forming Plant**) or **Electricity Storage Modules** and **Generating Units** or **Power Park Modules** (which could include **Grid Forming Plant**). **Generators** or **Grid Forming Plant Owners** should however be aware that for the purposes of compliance, full Grid Code compliance should be demonstrated when, for example, the **Electricity Storage Module** or **Grid Forming Plant** is out of service and the remaining **Power Generating Module** is in service or the **Electricity Storage Module** or **Grid Forming Plant** is in service and the **Power Generating Module** is out of service. Equally, **The Company** will accept **Manufacturer's Data & Performance Reports** for the purposes of proving compliance at co-located sites.

APPENDIX 1  
NOT USED

APPENDIX 2

**USER SELF CERTIFICATION OF COMPLIANCE (Interim/Final)**

<b>Power Station/ HVDC Equipment Station</b>	[Name of Connection Site/site of connection]	<b>User:</b>	[Full User name]	<b>Maximum Capacity (MW) of Plant:</b>	
--	--	--------------	------------------	--	--

This **User Self Certification of Compliance** records the compliance by the **EU Code User** in respect of [NAME] **Power Station/HVDC Equipment Station** with the **Grid Code** and the requirements of the **Bilateral Agreement** and **Construction Agreement** dated [ ] with reference number [ ]. It is completed by the **Power Station/HVDC System Owner** in the case of **Plant** and/or **Apparatus** connected to the **National Electricity Transmission System** and for **Embedded Plant**.

We have recorded our compliance against each requirement of the **Grid Code** which applies to the **Power Station/HVDC Equipment Station**, together with references to supporting evidence and a commentary where this is appropriate, and have provided this to **The Company**. A copy of the **Compliance Statement** is attached.

Supporting evidence, in the form of simulation results, test results, manufacturer’s data and other documentation, is attached in the **User Data File Structure**.

The **EU Code User** hereby certifies that, to the best of its knowledge and acting in accordance with **Good Industry Practice**, the **Power Station** is compliant with the **Grid Code** and the **Bilateral Agreement** in all aspects [with the following **Unresolved Issues\***] [with the following derogation(s)\*\*]:

<b>Connection Condition</b>	<b>Requirement</b>	<b>Ref:</b>	<b>Issue</b>

<b>Compliance certified by:</b>	Name:	Title:
	[PERSON]	[PERSON DESIGNATION]
	Signature:	Of
	[PERSON]	[User details]
	Date:	

\* Include for Interim **User Self Certification of Compliance** ahead of **Interim Operational Notification**.

\*\* Include for final **User Self Certification of Compliance** ahead of **Final Operational Notification** where derogation(s) have been granted. If no derogation(s) required delete wording and Table.

## APPENDIX 3

### SIMULATION STUDIES

#### ECP.A.3.1 SCOPE

- ECP.A.3.1.1 This Appendix sets out the simulation studies required to be submitted to **The Company** to demonstrate compliance with the **European Connection Conditions** unless otherwise agreed with **The Company**. This Appendix should be read in conjunction with ECP.6 with regard to the submission of the reports to **The Company**. Where there is any inconsistency in the technical requirements in respect of which compliance is being demonstrated by simulation in this Appendix and ECC.6.3 and the **Bilateral Agreement**, the provisions of the **Bilateral Agreement** and ECC.6.3 prevail. The studies specified in this Appendix will normally be sufficient to demonstrate compliance. However, **The Company** may agree an alternative set of studies proposed by the **Generator** or **HVDC System Owner** provided **The Company** deem the alternative set of studies sufficient to demonstrate compliance with the **Grid Code** and the **Bilateral Agreement**.
- ECP.A.3.1.2 The **Generator** or **HVDC System Owner** shall submit simulation studies in the form of a report to demonstrate compliance. In all cases the simulation studies must utilise models applicable to the **Synchronous Power Generating Module**, **HVDC Equipment** or **Power Park Module** with proposed or actual parameter settings. Reports should be submitted in English with all diagrams and graphs plotted clearly with legible axes and scaling provided to ensure any variations in plotted values is clear. In all cases, the simulation studies must be presented over a sufficient time period to demonstrate compliance with all applicable requirements.
- ECP.A.3.1.3 In the case of an **Offshore Power Station** where **OTSDUW Arrangements** apply simulation studies, the **Generator** should include the action of any relevant **OTSUA** where applicable to demonstrate compliance with the **Grid Code** and the **Bilateral Agreement** at the **Interface Point**.
- ECP.A.3.1.4 **The Company** will permit relaxation from the requirement ECP.A.3.2 to ECP.A.3.8 where an **Equipment Certificate** for the **Power Generating Module** or **HVDC Equipment** has been provided which details the characteristics from appropriate simulations on a representative installation with the same equipment and settings and the performance of the **Power Generating Module** or **HVDC Equipment** can, in **The Company's** opinion, reasonably represent that of the installed **Power Generating Module** or **HVDC Equipment**.
- ECP.A.3.1.5 For **Type B**, **Type C** and **Type D Power Generating Modules** the relevant **Equipment Certificate** must be supplied in the **Power Generating Module Document** or **Users Data File structure** as applicable. For **HVDC Equipment** the relevant **Equipment Certificates** must be supplied in the **Users Data File structure**.
- ECP.A.3.1.6 In the case of a co-located site, for example **Electricity Storage Modules** or **Grid Forming Plant** connected within a new or existing **Power Station**, **The Company** will accept simulation studies to demonstrate compliance at the **Grid Entry Point** or **User System Entry Point** (if **Embedded**) through a combination of the capabilities of the **Power Generating Modules** (which could include **Grid Forming Plant**) and **Electricity Storage Modules** or **Electricity Storage Modules** (which could include **Grid Forming Plant**) and **Generating Units** or **Power Park Modules**. **Generators** should however be aware that for the purposes of simulations, full **Grid Code** compliance should be demonstrated when, for example, the **Electricity Storage Module** or **Grid**

**Forming Plant** is out of service and the remaining **Power Generating Module** is in service or the **Electricity Storage Module** or **Grid Forming Plant** is in service and the **Power Generating Module** is out of service.

ECP.A.3.2 Power System Stabiliser Tuning

ECP.A.3.2.1 In the case of a **Synchronous Power Generating Module** with an **Excitation System Power System Stabiliser** the **Power System Stabiliser** tuning simulation study report required by ECC.A.6.2.5.6 or required by the **Bilateral Agreement** shall contain:

- (i) the **Excitation System** model including the **Power System Stabiliser** with settings as required under the **Planning Code** (PC.A.5.3.2(c)).
- (ii) open circuit time series simulation study of the response of the **Excitation System** to a +10% step change from 90% to 100% terminal voltage.
- (iii) on load time series dynamic simulation studies of the response of the **Excitation System** with and without the **Power System Stabiliser** to 2% and 10% steps in the reference voltage and a three phase short circuit fault applied to the higher voltage side of the **Synchronous Power Generating Module** transformer for 100ms. The simulation studies should be carried out with the **Synchronous Power Generating Module** operating at full **Active Power** and maximum leading **Reactive Power** import with the fault level at the **Supergrid** HV connection point at minimum or as otherwise agreed with **The Company**. The results should show the **Synchronous Power Generating Module** field voltage, terminal voltage, **Power System Stabiliser** output, **Active Power** and **Reactive Power** output.
- (iv) gain and phase Bode diagrams for the open loop frequency domain response of the **Synchronous Power Generating Module Excitation System** with and without the **Power System Stabiliser**. These should be in a suitable format to allow assessment of the phase contribution of the **Power System Stabiliser** and the gain and phase margin of the **Excitation System** with and without the **Power System Stabiliser** in service.
- (v) an eigenvalue plot to demonstrate that all modes remain stable when the **Power System Stabiliser** gain is increased by at least a factor of 3 from the designed operating value.
- (vi) gain Bode diagram for the closed loop on load frequency domain response of the **Synchronous Power Generating Module Excitation System** with and without the **Power System Stabiliser**. The **Synchronous Power Generating Module** operating at full load and at unity power factor. These diagrams should be in a suitable format to allow comparison of the **Active Power** damping across the frequency range specified in ECC.A.6.2.6.3 with and without the **Power System Stabiliser** in service.

In the case of a **Synchronous Power Generating Module** that may operate as **Demand** (e.g. **Pump Storage**) the on-load simulations (ii) to (vi) should also be carried out in both modes of operation.

ECP.A.3.2.2 In the case of **Onshore Non-Synchronous Power Generating Module, Onshore HVDC Equipment** and **Onshore Power Park Modules** and



**OTSDUW Plant and Apparatus at the Interface Point the Power System Stabiliser** tuning simulation study report required by ECC.A.7.2.4.1 or ECC.A.8.2.4 or required by the **Bilateral Agreement** shall contain:

- (i) the **Voltage Control System** model including the **Power System Stabiliser** with settings as required under the **Planning Code** (PC.A.5.4) and **Bilateral Agreement**.
- (ii) on load time series dynamic simulation studies of the response of the **Voltage Control System** with and without the **Power System Stabiliser** to 2% and 10% steps in the reference voltage and a three phase short circuit fault applied to the **Grid Entry Point** or the **Interface Point** in the case of **OTSDUW Plant and Apparatus** for 100ms. The simulation studies should be carried out operating at full **Active Power** and maximum leading **Reactive Power** import condition with the fault level at the **Supergrid HV** connection point at minimum or as otherwise agreed with **The Company**. The results should show appropriate signals to demonstrate the expected damping performance of the **Power System Stabiliser**.
- (iii) any other simulation as specified in the **Bilateral Agreement** or agreed between the **Generator** or **HVDC System Owner** or **Offshore Transmission Licensee** and **The Company**.

ECP.A.3.3 Reactive Capability across the Voltage Range

- ECP.A.3.3.1 (a) For a **Synchronous Power Generating Module**, the **Generator** shall supply simulation studies to demonstrate the capability to meet ECC.6.3.2 by submission of a report containing load flow simulation study results to demonstrate:
- (i) the maximum lagging **Reactive Power** capability at **Maximum Capacity** when the **Grid Entry Point** or **User System Entry Point** if **Embedded** or **Interface Point** (in the case of **OTSUA**) voltage is at 105% of nominal.
  - (ii) the maximum leading **Reactive Power** capability at **Maximum Capacity** when the **Grid Entry Point** or **User System Entry Point** if **Embedded** or **Interface Point** (in the case of **OTSUA**) voltage is at 95% of nominal.
  - (iii) the maximum lagging **Reactive Power** capability at the **Minimum Stable Operating Level** when the **Grid Entry Point** or **User System Entry Point** if **Embedded** or **Interface Point** (in the case of **OTSUA**) voltage is at 105% of nominal.
  - (iv) the maximum leading **Reactive Power** capability at the **Minimum Stable Operating Level** when the **Grid Entry Point** or **User System Entry Point** if **Embedded** or **Interface Point** (in the case of **OTSUA**) voltage is at 95% of nominal.
- (b) For an **OSTUA** with an **Interface Point** above 33kV or **Power Park Modules** with a **Grid Entry Point** or **User System Entry Point** above 33kV, the **Generator** shall demonstrate the capability to meet ECC.6.3.2 by submission of a report containing load flow simulation study results to demonstrate operation at points A, B, E and F in accordance with Figure ECC.A.7.2.2(b) or Figure ECC.A.8.2.2(b). The studies should be run with both the **OTSUA** and **Power Park Module** operating at **Maximum Capacity** and at the **Minimum Stable Operating Level**.

- (c) For an **OSTUA** with an **Interface Point** at or below 33kV or **Power Park Modules** with a **Grid Entry Point** or **User System Entry Point** at or below 33kV, a load flow simulation study results to demonstrate operation at points A, B, E and F in accordance with Figure ECC.A.7.2.2(c) or Figure ECC.A.8.2.2(b). The studies should be run with both the **OTSUA** and **Power Park Module** operating at **Maximum Capacity** and at the **Minimum Stable Operating Level**.
- (d) For an **HVDC system**, the **HVDC System Owner** shall supply simulation studies to demonstrate the capability to meet ECC.6.3.2 by submission of a report containing load flow simulation study results to demonstrate operation at points A, B, E and F in accordance with Figure ECC.A.7.2.2(b). The studies should be run with both the **HVDC System** operating at the **Maximum HVDC Active Power Transmission Capacity** and **Minimum HVDC Active Power Transmission Capacity**.

ECP.A.3.3.2 In the case of a **Synchronous Power Generating Module** the terminal voltage in the simulation should be the nominal voltage for the machine.

ECP.A.3.3.3 In the case of a **Power Park Module** where the load flow simulation studies show that the individual **Power Park Units** deviate from nominal voltage to meet the **Reactive Power** requirements then evidence must be provided from factory (e.g. in a **Manufacturer's Data & Performance Report**) or site testing that the **Power Park Unit** is capable of operating continuously at the operating points determined in the load flow simulation studies.

ECP.A.3.4 Voltage Control and Reactive Power Stability

ECP.A.3.4.1 This section applies to **HVDC Equipment**; and **Type C & Type D Power Park Modules** to demonstrate the voltage control capability and **Type B Power Park Modules** to demonstrate the voltage control capability if specified by **The Company**.

In the case of a **Power Station** containing **Power Park Modules** and/or **OTSUA**, the **Generator** shall provide a report to demonstrate the dynamic capability and control stability of the **Power Park Module**. The report shall contain:

- (i) a dynamic time series simulation study result of a sufficiently large negative step in **System** voltage to cause a change in **Reactive Power** from zero to the maximum lagging value at **Rated MW**.
- (ii) a dynamic time series simulation study result of a sufficiently large positive step in **System** voltage to cause a change in **Reactive Power** from zero to the maximum leading value at **Rated MW**.
- (iii) a dynamic time series simulation study result to demonstrate control stability at the lagging **Reactive Power** limit by application of a -2% voltage step while operating within 5% of the lagging **Reactive Power** limit.
- (iv) a dynamic time series simulation study result to demonstrate control stability at the leading **Reactive Power** limit by application of a +2% voltage step while operating within 5% of the leading **Reactive Power** limit.

- (v) a dynamic time series simulation study result of a sufficiently large negative step in **System** voltage to cause a change in **Reactive Power** from the maximum leading value to the maximum lagging value at **Rated MW**.

The **Generator** should also provide the voltage control study specified in ECP.A.3.7.4.

ECP.A.3.4.2 All the above studies should be completed with a network operating at the voltage applicable for zero **Reactive Power** transfer at the **Grid Entry Point** or **User System Entry Point** if **Embedded** or, in the case of **OTSUA, Interface Point** unless stated otherwise. The fault level at the HV connection point should be set at the minimum level as agreed with **The Company**.

ECP.A.3.5 Fault Ride Through and Fast Fault Current Injection

ECP.A.3.5.1 This section applies to **Type B, Type C and Type D Power Generating Modules** and **HVDC Equipment** to demonstrate the modules **Fault Ride Through** and **Fast Fault Current** injection capability.

The **Generator** or **HVDC System Owner** shall supply time series simulation study results to demonstrate the capability of **Synchronous Power Generating Module, HVDC Equipment, and Power Park Modules** and **OTSUA** to meet ECC.6.3.15 and ECC.6.3.16 by submission of a report containing:

- (i) a time series simulation study of a 140ms three phase short circuit fault with a retained voltage as detailed in table A.3.5.1 below applied at the **Grid Entry Point** or (**User System Entry Point** if **Embedded**) of the **Power Generating Module** or **HVDC Equipment** or **OTSUA**.
- (ii) a time series simulation study of 140ms unbalanced short circuit faults with a retained voltage as detailed in table 1 on the faulted phase(s) applied at the **Grid Entry Point** or (**User System Entry Point** if **Embedded**) of the **Power Generating Module** or **HVDC Equipment** or **OTSUA**. The unbalanced faults to be simulated are:
  1. a phase to phase fault
  2. a two phase to earth fault
  3. a single phase to earth fault.

<b>Power Generating Module</b>	Retained Voltage
<b>Synchronous Power Generating Module</b>	
<b>Type B</b>	30%
<b>Type C</b> or <b>Type D</b> with Grid connection point voltage <110kV	10%
<b>Type D</b> with connection point voltage >110kV	0%
<b>Power Park Module</b>	
<b>Type B</b> or <b>Type C</b> or <b>Type D</b> with connection point voltage < 110kV	10%
<b>Type D</b> with connection point voltage >110kV	0%
<b>HVDC Equipment</b>	0%

Table A.3.5.1

For a **Power Generating Module** or **HVDC Equipment** or **OTSUA** the simulation study should be completed with the **Power Generating Module** or **HVDC Equipment** or **OTSUA** operating at full **Active Power** and maximum leading **Reactive Power** and the fault level at

the **Supergrid** HV connection point at minimum or as otherwise agreed with **The Company** as detailed in ECC.6.3.15.8.

- (iii) time series simulation studies of balanced **Supergrid** voltage dips applied on the nearest point of the **National Electricity Transmission System** operating at **Supergrid** voltage to the **Synchronous Power Generating Module** or **OTSUA**. The simulation studies should include:

1. 50% retained voltage lasting 0.45 seconds
2. 70% retained voltage lasting 0.81 seconds
3. 80% retained voltage lasting 1.00 seconds
4. 85% retained voltage lasting 180 seconds.

For a **Synchronous Power Generating Module** or **OTSUA**, the simulation study should be completed with the **Synchronous Power Generating Module** or **OTSUA** operating at full **Active Power** and zero **Reactive Power** output and the fault level at the **Supergrid** HV connection point at minimum or as otherwise agreed with **The Company**. Where the **Synchronous Power Generating Module** is **Embedded**, the minimum **Network Operator's System** impedance to the **Supergrid HV Connection Point** shall be used which may be calculated from the maximum fault level at the **User System Entry Point**.

- (iv) time series simulation studies of balanced **Supergrid** voltage dips applied on the nearest point of the **National Electricity Transmission System** operating at **Supergrid** voltage to the **HVDC Equipment** or **Power Park Module**. The simulation studies should include:

1. 30% retained voltage lasting 0.384 seconds
2. 50% retained voltage lasting 0.71 seconds
3. 80% retained voltage lasting 2.5 seconds
4. 85% retained voltage lasting 180 seconds.

For **Power Park Modules** the simulation study should be completed with the **HVDC Equipment** or **Power Park Module** operating at full **Active Power** and zero **Reactive Power** output and the fault level at the **Supergrid HV Connection Point** at minimum or as otherwise agreed with **The Company**. Where the **Power Park Module** is **Embedded** the minimum **Network Operator's System** impedance to the **Supergrid HV Connection Point** shall be used which may be calculated from the maximum fault level at the **User System Entry Point**.

- (v) time series simulation studies of balanced **Supergrid** voltage dips applied on the nearest point of the **National Electricity Transmission System** operating at **Supergrid** voltage to the **HVDC Equipment**. The simulation studies should include:

1. 30% retained voltage
2. 50% retained voltage
3. 80% retained voltage
4. 85% retained voltage

For **HVDC Equipment** the simulation study should be completed with the **HVDC Equipment** operating at full **Active Power** transfer and zero **Reactive Power** output and the fault level at the **Supergrid** HV connection point at minimum or as otherwise agreed with **The Company**. Where the **HVDC Equipment** is **Embedded** the minimum **Network Operator's System** impedance to the **Supergrid** HV

connection point shall be used which may be calculated from the maximum fault level at the **User System Entry Point**.

For **HVDC Equipment** the duration of each voltage dip 1 to 4 above should demonstrate the requirements of the **Bilateral Agreement**.

- ECP.A.3.5.2 Not Used.
- ECP.A.3.5.3 In the case of a **Power Park Module** the studies detailed in ECP.A.3.5.1 should be repeated to demonstrate compliance during foreseeable running arrangements resulting from outages of major **Plant** and **Apparatus** (for example outage of the main export cable in the case of **OTSDUW** or module step up transformer where alternative export connections are possible). For these conditions, the **Power Park Module Active Power** output may be reduced to levels appropriate to the planned operating regime proposed by the **Generator**. The **Generator** shall consult **The Company** on alternative running arrangements and agree with **The Company** the running arrangements that will be studied prior to the **Generator** undertaking the studies. For the avoidance of doubt, compliance of a **Power Park Module** with **Fault Ride Through** requirements remains the responsibility of the **Generator** under all operating conditions.
- ECP.A.3.5.4 In the case of a **Power Park Module** with a **Registered Capacity** greater or equal to 100MW, the studies detailed in ECP.A.3.5.1 should be repeated with 50% of the **Power Park Units Synchronised** to the **Total System**. In the case of a **Power Station** containing multiple **Power Park Modules** or multiple **Offshore Power Park Modules** connected to an **Offshore Transmission System** or **OTSDUW** the study should include all **Power Park Modules** with 50% of the **Power Park Units Synchronised** to the **Total System**.
- ECP.A.3.5.5 In the case of **HVDC Equipment** the studies detailed in ECP.A.3.5.1 should be repeated to demonstrate compliance during foreseeable running arrangements resulting from outages of major **Plant** and **Apparatus** (for example outage of an HVDC cable or convertor. For these conditions, the **HVDC Equipment Active Power** transfer may be reduced to levels appropriate to the planned operating regime. The **Generator** or **HVDC System Owner** shall consult **The Company** on alternative running arrangements and agree with **The Company** the running arrangements that will be studied prior to the **Generator** or **HVDC System Owner** undertaking the studies. For the avoidance of doubt, compliance of **HVDC Equipment** with **Fault Ride Through** requirements remains the responsibility of the **Generator** or **HVDC System Owner** under all operating conditions.
- ECP.A.3.6 **Limited Frequency Sensitive Mode – Over Frequency (LFSM-O)**
- ECP.A.3.6.1 This section applies to **Type B, Type C and Type D Power Generating Modules, HVDC Equipment** to demonstrate the capability to modulate **Active Power** at high frequency as required by ECC6.3.7.3.5(ii).
- ECP.A.3.6.2 The simulation study should comprise of a **Power Generating Module** or **HVDC Equipment** connected to the total **System** with a local load shown as “X” in figure ECP.A.3.6.1. The load “X” is in addition to any auxiliary load of the **Power Station** connected directly to the **Power Generating Module** or **HVDC Equipment** and represents a small portion of the **System** to which the **Power Generating Module** or **HVDC Equipment** is attached. The value of “X” should be the minimum for which the **Power Generating Module** or **HVDC**

**Equipment** can control the power island **Frequency** to less than 52Hz consistent with ECC.6.3.7.3.5(ii). Where transient excursions above 52Hz occur the **Generator** or **HVDC Equipment Owner** should ensure that the duration above 52Hz is less than any high **Frequency** protection system applied to the **Power Generating Module** or **HVDC Equipment**.

ECP.A.3.6.3 For **HVDC Equipment** and **Power Park Modules** consisting of units connected wholly by power electronic devices the simulation methodology may be modified by the addition of a **Synchronous Power Generating Module (G2)** connected as indicated in Figure ECP.A.3.6.2. This additional **Synchronous Power Generating Module** should have an inertia constant of 3.5MWs/MVA, be initially operating at rated power output and unity **Power Factor**. The mechanical power of the **Synchronous Power Generating Module (G2)** should remain constant throughout the simulation.

ECP.A.3.6.4 At the start of the simulation study the **Power Generating Module** or **HVDC Equipment** will be operating maximum **Active Power** output. The **Power Generating Module** or **HVDC Equipment** will then be islanded from the **Total System** but still supplying load "X" by the opening of a breaker, which is not the **Power Generating Module** or **HVDC Equipment** connection circuit breaker (the governor should therefore, not receive any signals that the breaker has opened other than the reduction in load and subsequent increase in speed). A schematic arrangement of the simulation study is illustrated by Figure ECP.A.3.6.1.

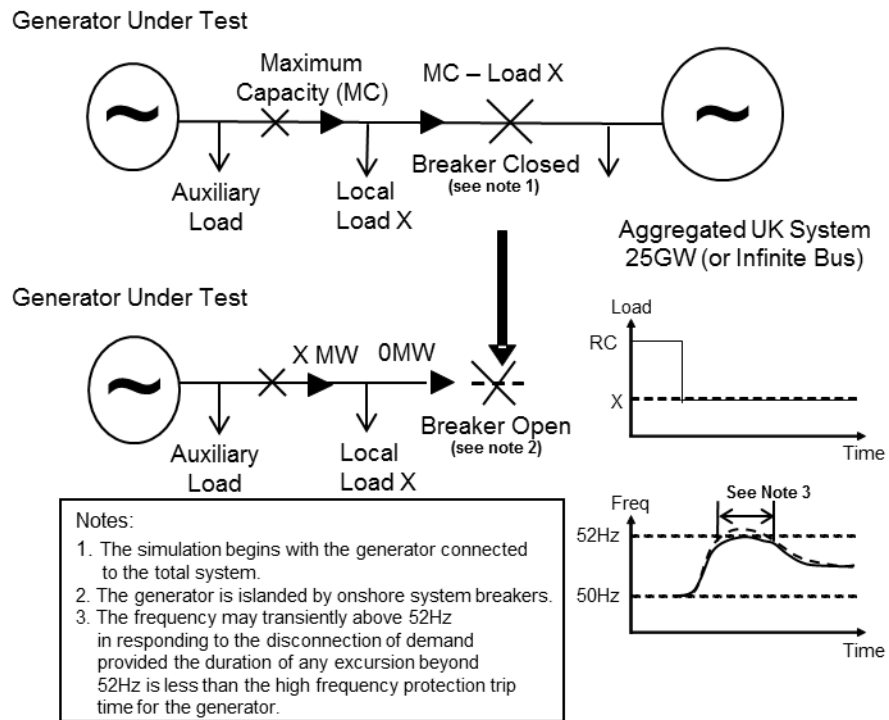

Figure ECP.A.3.6.1 – Diagram of Load Rejection Study

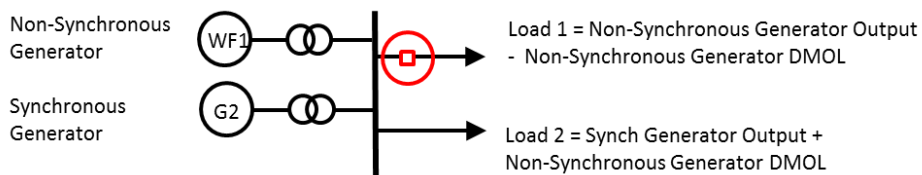

Figure ECP.A.3.6.2 – Addition of Generator G2 if applicable

ECP.A.3.6.5 A simulation study shall be performed for **Type B, C & D Power Generating Modules** in **Limited Frequency Sensitive Mode (LFSM)** and **Frequency Sensitive Mode (FSM)** for **Type C & D Power Generating Modules**. The simulation study results should indicate **Active Power** and **Frequency**.

ECP.A.3.6.6 To allow validation of the model used to simulate load rejection in accordance with ECC.6.3.7.3.5 as described, a further simulation study is required to represent the largest positive **Frequency** injection step or fast ramp (BC1 and BC3 of Figure 2) that will be applied as a test as described in ECP.A.5.8 and ECP.A.6.6.

**Limited Frequency Sensitive Mode – Under Frequency (LFSM-U)**

ECP.A.3.6.7 This section applies to:  
**Synchronous Power Generating Modules, Type C & D; or,**  
**HVDC Equipment; or,**  
**Power Park Modules, Type C & D** to demonstrate the modules capability to modulate Active Power at low frequency.

ECP.A.3.6.8 To demonstrate the **LFSM-U** low **Frequency** control when operating in **Limited Frequency Sensitive Mode** the **Generator** or **HVDC System Owner** shall submit a simulation study representing the response of the **Power Generating Module** or **HVDC Equipment** operating at 80% of **Maximum Capacity**. The simulation study event shall be equivalent to:

- (i) a sufficiently large reduction in the measured **System Frequency** ramped over 10 seconds to cause an increase in **Active Power** output to the **Maximum Capacity** followed by
- (ii) 60 seconds of steady state with the measured **System Frequency** depressed to the same level as in ECP.A.3.6.8.1 (i) as illustrated in Figure ECP.A.3.6.1 below.
- (iii) then increase of the measured **System Frequency** ramped over 10 seconds to cause a reduction in **Active Power** output back to the original **Active Power** level followed by at least 60 seconds of steady output.

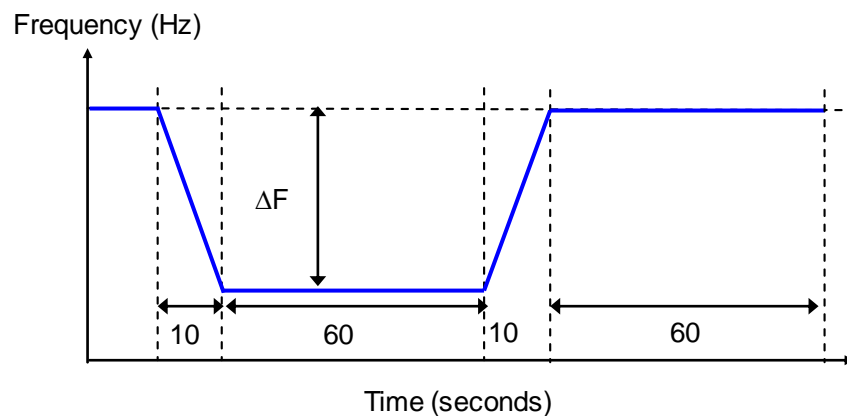

Figure ECP.A.3.6.1

ECP.A.3.7 Voltage and Frequency Controller Model Verification and Validation

ECP.A.3.7.1 For **Type C** and **Type D Synchronous Power Generating Modules, HVDC Equipment, OTSDUW Plant and Apparatus** or **Power Park Modules**, the **Generator** (including those undertaking **OTSDUW**) or **HVDC System Owner**

shall provide simulation studies to verify that the proposed controller models supplied to **The Company** under the **Planning Code** are fit for purpose. These simulation study results shall be provided in the timescales stated in the **Planning Code**.

ECP.A.3.7.2 To demonstrate the **Frequency** control or governor/load controller/plant model the **Generator** or **HVDC System Owner** shall submit a simulation study representing the response of the **Synchronous Power Generating Module, HVDC Equipment** or **Power Park Module** operating at 80% of **Maximum Capacity**. The simulation study event shall be equivalent to:

- (i) a ramped reduction in the measured **System Frequency** of 0.5Hz in 10 seconds followed by
- (ii) 20 seconds of steady state with the measured **System Frequency** depressed by 0.5Hz followed by
- (iii) a ramped increase in measured **System Frequency** of 0.3Hz over 30 seconds followed by
- (iv) 60 seconds of steady state with the measured **System Frequency** depressed by 0.2Hz as illustrated in Figure ECP.A.3.7.2 below.

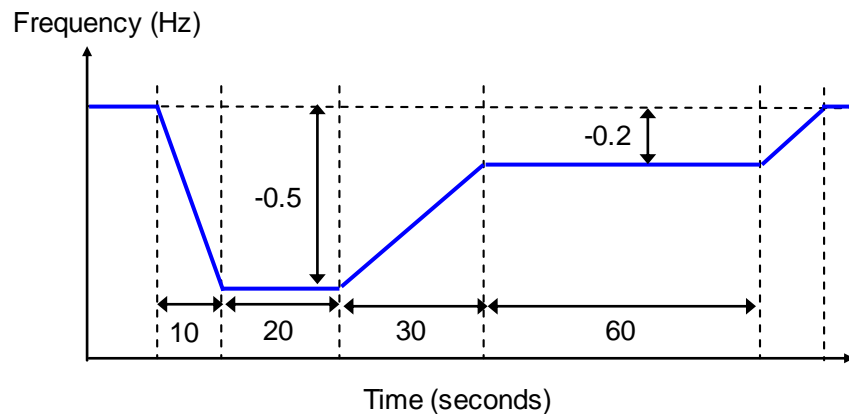

Figure ECP.A.3.7.2

The simulation study shall show **Active Power** output (MW) and the equivalent of **Frequency** injected.

ECP.A.3.7.3 To demonstrate the **Excitation System** model the **Generator** shall submit simulation studies representing the response of the **Synchronous Power Generating Module** as follows:

- (i) operating open circuit at rated terminal voltage and subjected to a 10% step increase in terminal voltage reference from 90% to 100%.
- (ii) operating at **Rated MW**, nominal terminal voltage and unity **Power Factor** subjected to a 2% step increase in the voltage reference. Where a **Power System Stabiliser** is included within the **Excitation System** this shall be in service.

The simulation study shall show the **Synchronous Power Generating Module** terminal voltage, field voltage, **Active Power**, **Reactive Power** and **Power System Stabiliser** output signal as appropriate.

ECP.A.3.7.4 To demonstrate the Voltage Controller model the **Generator** (including those undertaking **OTSDUW**) or **HVDC System Owner** shall submit a simulation study representing the response of the **HVDC Equipment, OTSDUW Plant and Apparatus** or **Power Park Module** operating at **Rated MW** and unity **Power Factor** at the connection point to a 2% step increase in the voltage reference. The simulation study shall show the terminal voltage, **Active**



**Power, Reactive Power and Power System Stabiliser** output signal as appropriate.

- ECP.A.3.7.5 To validate that the excitation and voltage control models submitted under the **Planning Code** are a reasonable representation of the dynamic behaviour of the **Synchronous Power Generating Module, OTSDUW Plant and Apparatus, HVDC Equipment or Power Park Module** as built, the **Generator or HVDC System Owner** shall repeat the simulation studies outlined above but using the operating conditions of the equivalent tests. The simulation study results shall be displayed overlaid on the actual test results.
- ECP.A.3.7.6 For **Type C and Type D Synchronous Power Generating Modules or HVDC Equipment** to validate that the governor/load controller/plant or **Frequency control models** submitted under the **Planning Code** is a reasonable representation of the dynamic behaviour of the **Synchronous Power Generating Module or HVDC Equipment Station** as built, the **Generator or HVDC System Owner** shall repeat the simulation studies outlined above but using the operating conditions of the equivalent tests. The simulation study results shall be displayed overlaid on the actual test results.
- ECP.A.3.8 Sub-synchronous Resonance control and Power Oscillation Damping control for HVDC System.
- ECP.A.3.8.1 To demonstrate the compliance of the sub-synchronous control capability with ECC.6.3.17.1) and the terms of the **Bilateral Agreement**, the **HVDC System Owner** shall submit a simulation study report.
- ECP.A.3.8.2 Where power oscillation damping control function is specified on a **HVDC Equipment** the **HVDC System Owner** shall submit a simulation study report to demonstrate the compliance with ECC.6.3.17.2 and the terms of the **Bilateral Agreement**.
- ECP.A.3.8.3 The simulation studies should utilise the **HVDC Equipment** control system models including the settings as required under the **Planning Code** (PC.A.5.3.2). The network conditions for the above simulation studies should be discussed with **The Company** prior to commencing any simulation studies.
- ECP.A.3.9 **Grid Forming Plant** verification and validation
- ECP.A.3.9.1 This section applies to **Users and Non-CUSC Parties** who own and operate **GBGF-I Plant** to demonstrate the ability of their **Grid Forming Plant** to satisfy the requirements of ECC.6.3.19. For the avoidance of doubt these requirements are not necessary from owner and operators of **GBGF-S Plant**.
- ECP.A.3.9.2 For initial approval **Users and Non-CUSC Parties** are required to submit the following data of their **Grid Forming Plant** to **The Company**: -
- a) The representation of their **Grid Forming Plant** in a format either the same as Figure PC.A.5.8.1 of PC.A.5.8.1 or in an equivalent format.
  - b) The data associated with their **Grid Forming Plant** as required in PC.A.5.8.1
  - c) A linearised model and parameters of the **Grid Forming Plant** in the frequency domain in the same format as required in PC.A.5.8.1 or equivalent.
  - d) A **Network Frequency Perturbation Plot** with a **Nichols Chart** demonstrating the equivalent **Damping Factor**.
  - e) For the items a) to d) the **User or Non-CUSC Party** can submit the data in any equivalent format as agreed with **The Company**.

ECP.A.3.9.3 For **GBGF-I**, the **User** or **Non-CUSC Party** may be required to supply other versions of the **Network Frequency Perturbation Plot** for different input and output signals as defined by **The Company**.

ECP.A.3.9.4 For final approval, **Users** and **Non-CUSC Parties** are required to demonstrate that the **GBGF\_I** model is capable of supplying **Active ROCOF Response Power**, and **Active Phase Jump Power**, and submit a full 3 phase simulation study in the time domain representing the response of the **Grid Forming Plant** over a range of operating conditions. The simulation study shall comprise of the following stages.

- i) A simulation study to the equivalent shown in Figure ECP.A.3.9.4.

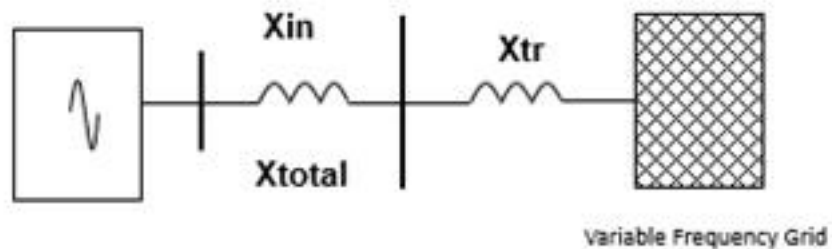

Figure ECP.A.3.9.4

- ii) The first simulation test is to demonstrate that the **GBGF-I** model is capable of supplying **Active ROCOF Response Power** to the **Total System** as a result of a **System Frequency** change. In this simulation, with the **Grid Forming Plant** initially running at **Registered Capacity** or **Maximum Capacity**, the **Grid System Frequency** is increased from 50Hz to 51Hz at a rate of 1Hz/s with measurements of the **Grid Forming Plant's Active ROCOF Response Power**, **System Frequency** and time in (ms). The simulation is required to assess correct operation of the **Grid Forming Plant** without saturating. Repeat for 50Hz to 49Hz at 1Hz/s.
- iii) The second simulation test is to demonstrate the **GBGF-I's** ability to supply **Active ROCOF Response Power** and assess its withstand capability under extreme **System Frequencies**. The **Grid System Frequency** is increased from 50Hz to 52Hz at a rate of 1Hz/s with measurements of the **Active ROCOF Response Power**, **System Frequency** and time in (ms). This is repeated when the **Grid System Frequency** is increased from 50Hz to 52Hz at a rate of 2 Hz/s with measurements of the **Active ROCOF Response Power**, **System Frequency** and time in (ms). Repeat for 50Hz to 48 Hz at 1 Hz/s and 50Hz to 48 Hz at 2 Hz/s.
- iv) The third simulation is to demonstrate the **Grid Forming Plant's** ability to supply **Active ROCOF Response Power** over the full **System Frequency** range.
- (a) With the **System Frequency** set to 50Hz, the **Grid Forming Plant** should be initially running at 75% **Maximum Capacity** or 75% **Registered Capacity**, zero MVar output and both **Limited Frequency Sensitive Mode** and **Frequency Sensitive Mode** disabled.

- (b) The **System Frequency** is then increased from 50Hz to 52Hz at a rate of 1Hz/s over a 2 second period. Allow conditions to stabilise for 5 seconds and then decrease the **System Frequency** from 52Hz to 47Hz at a rate of 1Hz/s over a 5 second period. Allow conditions to stabilise.
  - (c) Record results of phase based **Active ROCOF Response Power**, **Reactive Power**, voltage and **System Frequency**.
  - (d) The simulation now needs to be re-run in the opposite direction. The same initial conditions should be applied as per ECP.A.3.9.2iv) (a).
  - (e) The **System Frequency** is then decreased from 50Hz to 47Hz at a rate of 1Hz/s over a 3 second period. Allow conditions to stabilise for 5 seconds and then increase the **System Frequency** from 47Hz to 52Hz at a rate of 1Hz/s over a 5 second period. Allow conditions to stabilise.
  - (f) Record results of **Active ROCOF Response Power**, **Reactive Power**, voltage and **System Frequency**.
  - (g) The simulation is required to ensure the **Grid Forming Plant** can deliver **Active ROCOF Response Power** without going into saturation and that a behaviour that is equivalent to pole slipping does not occur.
- v) The fourth simulation is to demonstrate the **Grid Forming Plant's** ability to supply **Active Phase Jump Power** under normal operation.
- (a) With the **System Frequency** set to 50Hz, the **Grid Forming Plant** should initially be running at **Maximum Capacity** or **Registered Capacity** or a suitable loading point to demonstrate **Grid Forming Capability** as agreed with **The Company**, zero MVAR output and all control actions (e.g. **Limited Frequency Sensitive Mode**, **Frequency Sensitive Mode** and voltage control) disabled.
  - (b) Apply a positive phase jump of the **Phase Jump Angle Limit** value at the **Grid Entry Point** or **User System Entry Point**.
  - (c) Record traces of **Active Power**, **Reactive Power**, voltage, current and **System Frequency** for a period of 10 seconds after the step change in phase has been applied. Repeat with a negative phase jump.
- vi) The fifth simulation is to demonstrate the **Grid Forming Plant's** ability to supply **Active Phase Jump Power** under extreme conditions.
- (a) With the **System Frequency** set to 50Hz, the **Grid Forming Plant** should be initially running at its **Minimum Stable Operating Level** or **Minimum Stable Generation**, zero MVAR output and all control actions (e.g. **Limited Frequency Sensitive Mode**, **Frequency Sensitive Mode** and voltage control) disabled.
  - (b) Apply a phase jump equivalent to the positive **Phase Jump Angle Withstand** value at the **Grid**.
  - (c) Record traces of **Active Power**, **Reactive Power**, voltage, current and **System Frequency** for a period of 10 seconds after the step change in phase has been applied. Repeat with a negative phase jump.
  - (d) Repeat steps (a), (b) and (c) of ECP.A.3.9.4(vi) but on this occasion apply a phase jump equivalent to the positive **Phase Jump Angle Limit** at the **Grid**.

vii) The sixth simulation is to demonstrate the **Grid Forming Plant's** ability to supply **Fault Ride Through** and **GBGF Fast Fault Current Injection** during a faulted condition

- (a) With the **System Frequency** set to 50Hz, the **Grid Forming Plant** should be initially running at its **Maximum Capacity** or **Registered Capacity**, zero MVar output and all control actions (e.g., **Limited Frequency Sensitive Mode**, **Frequency Sensitive Mode**, **GBGF Fast Fault Current Injection**, **Fault Ride Through** and voltage control other than current limiters) disabled.
- (b) Apply a solid three phase short circuit fault at the **Grid Entry Point** or **User System Entry Point** for 140ms.
- (c) Record traces of **Active Power**, **Reactive Power**, voltage, current and **System Frequency** for a period of 10 seconds after the fault has been applied. The **GBGF-I's** current limit should be observed to operate.
- (d) Repeat steps (a) to (c) but on this occasion with **Fault Ride Through**, **GBGF Fast Fault Current Injection**, **Limited Frequency Sensitive Mode** and voltage control switched into service.
- (e) Record traces of **Active Power**, **Reactive Power**, voltage, current and **System Frequency** for a period of 10 seconds after the fault has been applied and confirm correct operation.

ECP.A.3.9.5 To demonstrate the **GBGF-I** model is capable of supplying **Active ROCOF Response Power** and **Active Phase Jump Power**, under extreme conditions the **Grid Forming Plant Owner** shall submit a simulation study representing the response of the **Grid Forming Plant**. To demonstrate the performance of the **Grid Forming Plant** under these conditions, the simulation study shall represent the following scenario.

- i) The **User** or **Non-CUSC Party** in respect of **GBGF-I** should supply a simulation study to **The Company** equivalent to Figure ECP.A.3.9.5.

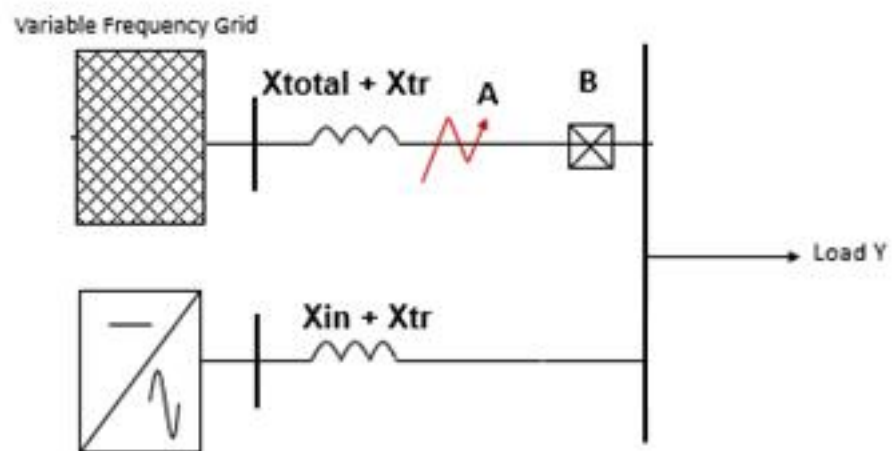

Figure ECP.A.3.9.5

- ii) In this simulation (as shown in Figure ECP.A.3.9.5) the parameters of the variable frequency Grid shall be supplied by **The Company**. The Load Y is also defined by **The Company**.
- iii) With the system running in steady state the **GBGF-I** and the variable frequency AC Grid should each be running at load Y/2 with the **System Frequency** of the test network being 50Hz. All control actions (e.g., **Limited Frequency Sensitive Mode, Frequency Sensitive Mode** and voltage control) should be disabled.
- iv) With the system in steady state, apply a solid (zero impedance) three phase short circuit fault at point A of Figure ECP.A.3.9.3 and then open circuit breaker B, 140ms after the fault has been applied.
- v) Record traces of **Active Power, Reactive Power, voltage** and **System Frequency** and record for a period of time after fault inception after allowing conditions to stabilise.

ECP.A.3.9.6 To demonstrate the **Grid Forming Plant** model is capable of contributing to **Active Damping Power**, the **GBGF-I** owner is required to supply a simulation study by injecting a **Test Signal** in the time domain into the model of the **GBGF-I**.

The **GBGF-I** model should take the equivalent form shown in either Figure ECP.A.3.9.6(a) or Figure ECP.A.3.9.6(b) as applicable. Each **User** or **Non-CUSC Party** can use their own design, that may be very different to Figures ECP.A.3.9.6(a) or ECP.A.3.9.6 (b) but should contain all relevant functions. In either case the following tests should be completed, and results supplied to verify the following criteria: -

**Typical simulation model 1**

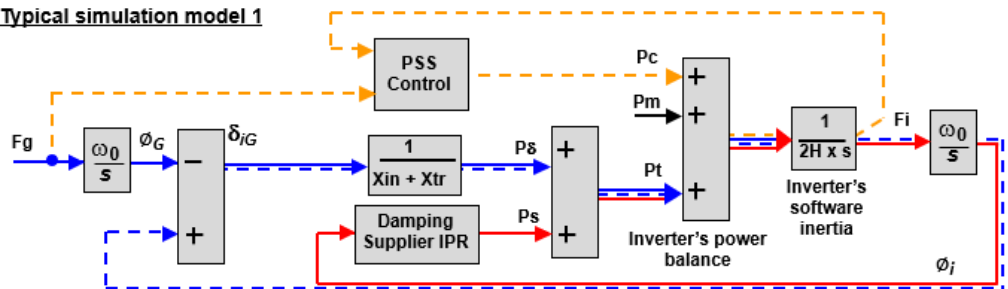

Figure ECP.A.3.9.6(a)

**Typical simulation model 2**

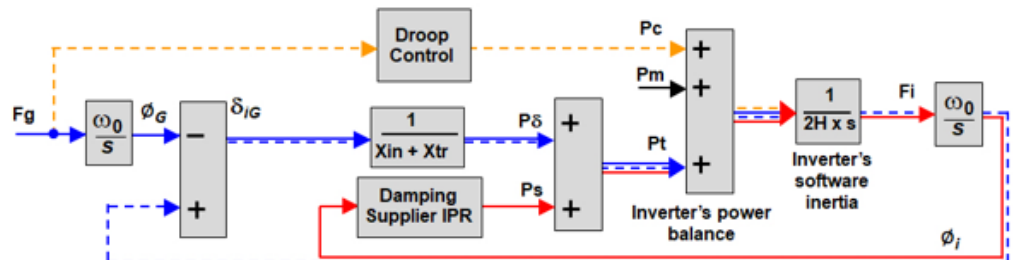

Figure ECP.A.3.9.6(b)

- i) Demonstration of **Damping** by injecting a **Test Signal** in the time domain at the **Grid Oscillation Value** and frequency into the model of the **GBGF-I**. An acceptable performance will be judged when the result matches the **NFP Plot** declared by the **Grid Forming Plant Owner** as submitted in PC.A.5.8.1(i)

- ii) Test i) is repeated with variations in the frequency of the **Test Signal**. An acceptable performance will be judged when the result matches the **NFP Plot** declared by the **Grid Forming Plant Owner** as submitted in PC.A.5.8.1(i).
- iii) Demonstration of phase based **Active Control Output Power** (or  $P_c$ ) by injecting a **Test Signal** into the **Grid Forming Plant** controller to demonstrate that the **Active Control Based Power** output is supplied below the 5Hz bandwidth limit. An acceptable performance will be judged where the overshoot and decay matches the **Damping Factor** declared by the **Grid Forming Plant Owner** as submitted in PC.A.5.8.1 in addition to assessment against the requirements of CC.A.6.2.6.1 or ECC.A.6.2.6.1 or CC.A.7.2.2.5 or ECC.A.7.2.5.2 as applicable.

APPENDIX 4

ONSITE SIGNAL PROVISION FOR WITNESSING TESTS

ECP.A.4.1 During any tests witnessed on-site by **The Company**, the following signals shall be provided to **The Company** by the **Generator** undertaking **OTSDUW or HVDC System Owner** in accordance with ECC.6.6.3.

ECP.A.4.2 **Synchronous Power Generating Modules**

ECP.A.4.2(a) All Tests	<ul style="list-style-type: none"> <li>• MW - <b>Active Power</b> at <b>Synchronous Generating Unit</b> terminals</li> </ul>
ECP.A.4.2(b) Reactive & <b>Excitation System</b>	<ul style="list-style-type: none"> <li>• MVar - <b>Reactive Power</b> at terminals</li> <li>• Vt - <b>Synchronous Generating Unit</b> terminal voltage</li> <li>• Efd- <b>Synchronous Generating Unit</b> field voltage and/or main exciter field voltage</li> <li>• Ifd – <b>Synchronous Generating Unit</b> Field current (where possible)</li> <li>• <b>Power System Stabiliser</b> output, where applicable.</li> <li>• Noise – Injected noise signal (where applicable and possible)</li> </ul>
ECP.A.4.2(c) Governor System & <b>Frequency Response</b>	<ul style="list-style-type: none"> <li>• Fsys - <b>System Frequency</b></li> <li>• Finj - Injected Speed Setpoint</li> <li>• Logic - Stop / Start Logic Signal</li> </ul> <p>For Gas Turbines:</p> <ul style="list-style-type: none"> <li>• GT Fuel Demand</li> <li>• GT Fuel Valve Position</li> <li>• GT Inlet Guide Vane Position</li> <li>• GT Exhaust Gas Temperature</li> </ul> <p>For Steam Turbines at &gt;= 1Hz:</p> <ul style="list-style-type: none"> <li>• Pressure before Turbine Governor Valves</li> <li>• Turbine Governor Valve Positions</li> <li>• Governor Oil Pressure*</li> <li>• Boiler Pressure Set Point *</li> <li>• Superheater Outlet Pressure *</li> <li>• Pressure after Turbine Governor Valves*</li> <li>• Boiler Firing Demand*</li> </ul> <p>*Where applicable (typically not in <b>CCGT module</b>)</p> <p>For Hydro Plant:</p> <ul style="list-style-type: none"> <li>• Speed Governor Demand Signal</li> <li>• Actuator Output Signal</li> <li>• Guide Vane / Needle Valve Position</li> </ul>
ECP.A.4.2(d) Compliance with ECC.6.3.3	<ul style="list-style-type: none"> <li>• Fsys - <b>System Frequency</b></li> <li>• Finj - Injected Speed Setpoint</li> <li>• Appropriate control system parameters as agreed with <b>The Company</b> (See ECP.A.5.9)</li> </ul>
ECP.A.4.2(e) Real Time on site or Down-loadable	<ul style="list-style-type: none"> <li>• MW - <b>Synchronous Power Generating Module Active Power</b> at the <b>Grid Entry Point</b> or (<b>User System Entry Point</b> if <b>Embedded</b>).</li> <li>• MVar - <b>Synchronous Power Generating Module Reactive Power</b> at the <b>Grid Entry Point</b> or (<b>User System Entry Point</b> if <b>Embedded</b>).</li> </ul>

	<ul style="list-style-type: none"> <li>Line-line Voltage (kV) at the <b>Grid Entry Point</b> or (<b>User System Entry Point</b> if <b>Embedded</b>).</li> </ul>
--	---

ECP.A.4.3 **Power Park Modules, OTSDUA and HVDC Equipment**

	Each <b>Power Park Module</b> and <b>HVDC Equipment</b> at <b>Grid Entry Point</b> or <b>User System Entry Point</b>
ECP.A.4.3.1(a) Real Time on site.	<ul style="list-style-type: none"> <li>Total <b>Active Power</b> (MW)</li> <li>Total <b>Reactive Power</b> (MVA<sub>r</sub>)</li> <li>Line-line Voltage (kV)</li> <li><b>System Frequency</b> (Hz)</li> </ul>
ECP.A.4.3.1(b) Real Time on site or Down-loadable	<ul style="list-style-type: none"> <li>Injected frequency signal (Hz) or test logic signal (Boolean) when appropriate</li> <li>Injected voltage signal (per unit voltage) or test logic signal (Boolean) when appropriate</li> <li>In the case of an <b>Onshore Power Park Module</b> the <b>Onshore Power Park Module</b> site voltage (MV) (kV)</li> <li><b>Power System Stabiliser</b> output, where appropriate</li> <li>In the case of a <b>Power Park Module</b> or <b>HVDC Equipment</b> where the <b>Reactive Power</b> is provided by more than one <b>Reactive Power</b> source, the individual <b>Reactive Power</b> contributions from each source, as agreed with <b>The Company</b>.</li> <li>In the case of <b>HVDC Equipment</b> appropriate control system parameters as agreed with <b>The Company</b> (See ECP.A.7)</li> <li>In the case of an <b>Offshore Power Park Module</b> the Total <b>Active Power</b> (MW) and the Total <b>Reactive Power</b> (MVA<sub>r</sub>) at the offshore <b>Grid Entry Point</b></li> </ul>
ECP.A.4.3.1(c) Real Time on site or Down-loadable	<ul style="list-style-type: none"> <li>Available power for <b>Power Park Module</b> (MW)</li> <li>Power source speed for <b>Power Park Module</b> (e.g. wind speed) (m/s) when appropriate</li> <li>Power source direction for <b>Power Park Module</b> (degrees) when appropriate</li> </ul> <p>See ECP.A.4.3.2</p>

ECP.A.4.3.2 **The Company** accept that the signals specified in ECP.A.4.3.1(c) may have lower effective sample rates than those required in ECC.6.6.3 although any signals supplied for connection to **The Company's** recording equipment which do not meet at least the sample rates detailed in ECC.6.6.3 should have the actual sample rates indicated to **The Company** before testing commences.

ECP.A.4.3.3 For all **The Company** witnessed testing either;

- (i) the **Generator** or **HVDC System Owner** shall provide to **The Company** all signals outlined in ECP.A.4.3.1 direct from the **Power Park Module** control system without any attenuation, delay or filtering which would result in the inability to fully demonstrate the objectives of the test, or identify any potential safety or plant instability issues, and with a signal update rate corresponding to ECC.6.6.3.2; or
- (ii) in the case of **Onshore Power Park Modules**, the **Generator** or **HVDC System Owner** shall provide signals ECP.A.4.3.1(a) direct from one or more transducer(s) connected to current and voltage transformers for monitoring in real time on site; or,



- (iii) In the case of **Offshore Power Park Modules** and **OTSDUA** signals ECP.A.4.3.1(a) will be provided at the **Interface Point** by the **Offshore Transmission Licensee** pursuant to the **STC** or by the **Generator** when **OTSDUW Arrangements** apply.

ECP.A.4.3.4 Options ECP.A.4.3.3 (ii) and (iii) will only be available on condition that;

- (a) all signals outlined in ECP.A.4.3.1 are recorded and made available to **The Company** by the **Generator** or **HVDC System Owner** from the **Power Park Module** or **OTSDUA** or **HVDC Equipment** control systems as a download once the testing has been completed; and
- (b) the full test results are provided by the **Generator HVDC System Owner** within 2 working days of the test date to **The Company** unless **The Company** agrees otherwise; and
- (c) all data is provided with a sample rate in accordance with ECC.6.6.3.3 unless **The Company** agrees otherwise; and
- (d) in **The Company's** reasonable opinion, the solution does not unreasonably add a significant delay between tests or impede the volume of testing which can take place on the day.

ECP.A.4.3.5 In the case of where transducers connected to current and voltage transformers are installed (ECP.A.4. 3.3(ii) and (iii)), the transducers shall meet the following specification

- (a) The transducer(s) shall be permanently installed to easily allow safe testing at any point in the future, and to avoid a requirement for recalibration of the current transformers and voltage transformers.
- (b) The transducer(s) should be directly connected to the metering quality current transformers and voltage transformers or similar.
- (c) The transducers shall either have a response time no greater than 50ms to reach 90% of output, or no greater than 300ms to reach 99.5%.

ECP.A.4.3.6 In the case of a **GBGF-I** system, the following signals shall be supplied to **The Company** by the **Grid Forming Plant Owner** in accordance with ECC.6.6.3. For the avoidance of doubt, **User's** and **Non-CUSC Parties** will also be required to undertake the necessary testing of their **Plant** in accordance with the requirements of ECC.A.4 and OC5 as applicable.

	Each <b>Grid Forming Plant</b> at the <b>Grid Entry Point</b> or <b>User System Entry Point</b>
ECP.A.4.3.6(a) Real Time Downloadable	Signals required shall be agreed with <b>The Company</b> in accordance with ECC.6.6.3.2(iv) and ECC.6.6.3.2(v)

ECP.A.4.3.7 Testing not witnessed by **The Company** on-site

ECP.A.4.3.7.1.1 Where **The Company** has decided not to witness testing on-site, the results shall be submitted to **The Company** in spreadsheet format with the signal data in columns arranged as follows. Signal data denoted by “#” is not essential but if not provided the column should remain in place but without values entered. Where two signal names are given in a column these are alternatives related to the type of plant under test.

ECP.A.4.3.7.1.2 Where **The Company** has requested addition signals to be recorded prior to the testing these signals shall be placed in columns to the right of the spreadsheet.

ECP.A.4.3.7.2.1 Onshore Synchronous Generating Unit Excitation System and Reactive Capability

	Col 1	Col 2	Col 3	Col 4	Col 5	Col 6	Col 7	Col 8
1	Time	Active Power	Reactive Power	Terminal Voltage	Speed /Frequency #	Freq Injection #	Logic / Test Start #	Field Voltage
	Col 9	Col 10	Col 11	Col 12	Col 13	Col 14	Col 15	Col 16
1	Field Current	PSS Output #	Noise Injection #					
# Columns may be left blank but the column must still be included in the files								

ECP.A.4.3.7.2.2 Onshore Synchronous Generating Unit Frequency Response and ECC.6.3.3

	Col 1	Col 2	Col 3	Col 4	Col 5	Col 6	Col 7	Col 8
1	Time	Active Power	Reactive Power #	Terminal Voltage #	Speed /Frequency	Freq Injection	Logic / Test Start	Fuel Demand
2								Guide Vane Setpoint
	Col 9	Col 10	Col 11	Col 12	Col 13	Col 14	Col 15	Col 16
1	Inlet Guide Vane	Exhaust Gas Temp	ST Valve Pos	Fuel Valve Pos	HP Steam Valve Pos	IP Steam Valve Pos	LP Steam Valve Pos	
2	Guide Vane Position	Head						
# Columns may be left blank but must still be included in the files								

ECP.A.4.3.7.3.1 Onshore Power Park Modules Voltage Control & Reactive Capability

	Col 1	Col 2	Col 3	Col 4	Col 5	Col 6	Col 7	Col 8
1	Time	Active Power	Reactive Power	Connection Point Voltage	Speed /Frequency #	Freq Injection #	Logic / Test Start #	Statcom or Windfarm Reactive Power #

	Col 9	Col 10	Col 11	Col 12	Col 13	Col 14	Col 15	Col 16
1	Power Available	Wind Speed	Wind Direction	Voltage Setpoint				
2	State of Charge							
# Columns may be left blank but the column must still be included in the files								

ECP.A.4.3.7.3.2 Offshore Power Park Modules Voltage Control & Reactive Capability

	Col 1	Col 2	Col 3	Col 4	Col 5	Col 6	Col 7	Col 8
1	Time	Onshore Interface Point Active Power	Onshore Interface Point Reactive Power	Onshore Interface Point Voltage	Speed /Frequency #	Freq Injection #	Logic / Test Start #	Statcom or Windfarm Reactive Power #
	Col 9	Col 10	Col 11	Col 12	Col 13	Col 14	Col 15	Col 16
1	Power Available	Wind Speed m/s	Wind Direction	Voltage Setpoint				
2	State of Charge							
# Columns may be left blank but the column must still be included in the files								

ECP.A.4.3.7.3.3 Power Park Module Frequency Control

	Col 1	Col 2	Col 3	Col 4	Col 5	Col 6	Col 7	Col 8
1	Time	GEP Active Power	GEP Reactive Power #	GEP Connection Voltage #	Speed /Frequency	Freq Injection	Logic / Test Start	Statcom or Windfarm Reactive Power #
	Col 9	Col 10	Col 11	Col 12	Col 13	Col 14	Col 15	Col 16
1	Power Available	Wind Speed m/s	Wind Direction					
2	State of Charge							
# Columns may be left blank but must still be included in the files								

ECP.A.4.3.8.1 Where test results are completed without the presence of **The Company** but are relied upon as evidence of the compliance they should be accompanied by a logsheet. This sheet should be legible, in English and detail the items as indicated below:

Time and Date of test;

Name of **Power Station** and **Power Generating Module** if applicable;  
Name of Test engineer(s) and company name;  
Name of **Users** representative(s) and company name;  
Type of testing being undertake eg Voltage Control;  
Ambient conditions eg. temperature, pressure, wind speed, wind direction;  
and  
Controller settings, eg voltage slope, frequency droop, voltage setpoint, UEL  
& OEL settings

ECP.A.4.3.8.2 For each test the following items should be recorded as relevant to the type of test being undertaken. Where there is uncertainty on the information to be recorded this should be discussed with **The Company** in advance of the test.

ECP.A.4.3.8.2 .1 Voltage Control Tests

Start time of each test step;

**Active Power;**

**Reactive Power;**

Connection voltage;

Voltage Control Setpoint, if applicable or changed;

Voltage Control Slope, if applicable or changed;

Terminal Voltage if applicable;

Generator transformer tap position or grid transformer tap position, as applicable;

Number of **Power Park Units** in service in each **Power Park Module**, if applicable; and

For offshore connections **Offshore Grid Entry Point** voltage.

ECP.A.4.3.8.2.2 Reactive Power Capability Tests

Start time of test;

**Active Power;**

**Reactive Power;**

Connection Voltage;

Terminal Voltage if applicable;

**Generating Unit** transformer tap position or grid transformer tap position as applicable;

Number of **Power Park Units** in service in each **Power Park Module**, if applicable; and

For offshore connections **Offshore Grid Entry Point** voltage.

ECP.A.4.3.8.2.3 Frequency Response Capability Tests

Start time of test;

**Active Power;**

**System Frequency;**

For **CCGT Modules, Active Power** for the individual units (GT &ST);

For boiler plant, HP steam pressure;

Droop setting of controller if applicable;

Number of **Power Park Units** in service in each **Power Park Module**, if applicable; and

For offshore connections **Offshore Grid Entry Point Active Power** for each **Power Park Module**.

ECP.A.4.3.8.3 Material changes during the test period should be recorded e.g. **Generating Units** tripping / starting, changes to tapchange positions.

## APPENDIX 5

### COMPLIANCE TESTING OF SYNCHRONOUS POWER GENERATING MODULES

#### ECP.A.5.1 SCOPE

ECP.A.5.1.1 This Appendix sets out the tests contained therein to demonstrate compliance with the relevant clauses of the **European Connection Conditions** of the **Grid Code**. This Appendix shall be read in conjunction with the ECP with regard to the submission of the reports to **The Company**.

ECP.A.5.1.2 The tests specified in this Appendix will normally be sufficient to demonstrate compliance however **The Company** may:

- (i) agree an alternative set of tests provided **The Company** deem the alternative set of tests sufficient to demonstrate compliance with the **Grid Code** and **Bilateral Agreement**; and/or
- (ii) require additional or alternative tests if information supplied to **The Company** during the compliance process suggests that the tests in this Appendix will not fully demonstrate compliance with the relevant section of the **Grid Code** or **Bilateral Agreement**.
- (iii) Agree a reduced set of tests for subsequent **Synchronous Power Generating Module** following successful completion of the first **Synchronous Power Generating Module** tests in the case of a **Power Station** comprised of two or more **Synchronous Power Generating Modules** which **The Company** reasonably considers to be identical.

If:

- (a) the tests performed pursuant to ECP.A.5.1.2(iii) in respect of subsequent **Synchronous Power Generating Modules** do not replicate the full tests for the first **Synchronous Power Generating Module**, or
- (b) any of the tests performed pursuant to ECP.A.5.1.2(iii) do not fully demonstrate compliance with the relevant aspects of the **Grid Code**, **Ancillary Services Agreement** and / or **Bilateral Agreement**,

then notwithstanding the provisions above, the full testing requirements set out in this Appendix will be applied.

ECP.A.5.1.3 The **Generator** is responsible for carrying out the tests set out in and in accordance with this Appendix and the **Generator** retains the responsibility for the safety of personnel and plant during the test. **The Company** will witness all of the tests outlined or agreed in relation to this Appendix unless **The Company** decides and notifies the **Generator** otherwise. Reactive Capability tests may be witnessed by **The Company** remotely from **The Company** control centre. For all on site, **The Company** witnessed tests the **Generator** should ensure suitable representatives from the **Generator** and manufacturer (if appropriate) are available on site for the entire testing period. In all cases the **Generator** shall provide suitable monitoring equipment to record all relevant test signals as outlined below in ECP.A.6.1.5.

ECP.A.5.1.4 The **Generator** shall submit a schedule of tests to **The Company** in accordance with CP.4.3.1.

ECP.A.5.1.5 Prior to the testing of a **Synchronous Power Generating Module** the

**Generator** shall complete the **Integral Equipment Test** procedure in accordance with OC.7.5.

ECP.A.5.1.6 Full **Synchronous Power Generating Module** testing as required by CP.7.2 is to be completed as defined in ECP.A.5.2 through to ECP.A.5.9.

ECP.A.5.1.7 **The Company** will permit relaxation from the requirement ECP.A.5.2 to ECP.A.5.9 where an **Equipment Certificate** for the **Synchronous Power Generating Module** has been provided which details the characteristics from tests on a representative machine with the same equipment and settings and the performance of the **Synchronous Power Generating Module** can, in **The Company's** opinion, reasonably represent that of the installed **Synchronous Power Generating Module** at that site. For **Type B, Type C** and **Type D Power Generating Modules** the relevant **Equipment Certificate** must be supplied in the **Power Generating Module Document** or **Users Data File structure** as applicable.

ECP.A.5.1.8 In the case of a co-located site, for example **Electricity Storage Modules** or **Grid Forming Plant** connected within a new or existing **Power Station**, **The Company** will accept test results to demonstrate compliance at the **Grid Entry Point** or **User System Entry Point** (if **Embedded**) through a combination of the capabilities of the **Power Generating Modules** (which could include **Grid Forming Plant**) and **Electricity Storage Modules** or **Electricity Storage Modules** (which could include a **Grid Forming Plant**) and **Generating Units** or **Power Park Modules**. **Generators** should however be aware that for the purposes of testing, full Grid Code compliance should be demonstrated when, for example, the **Electricity Storage Module** or **Grid Forming Plant** is out of service and the remaining **Power Generating Module** is in service or the **Electricity Storage Module** or **Grid Forming Plant** is in service and the **Power Generating Module** is out of service. In the case of a **Synchronous Electricity Storage Module**, **The Company** would expect the full set of tests to be completed as detailed in ECP.A.5.2 to ECP.A.5.9.

ECP.A.5.2 Excitation System Open Circuit Step Response Tests

ECP.A.5.2.1 The open circuit step response of the **Excitation System** will be tested by applying a voltage step change from 90% to 100% of the nominal **Synchronous Power Generating Module** terminal voltage, with the **Synchronous Power Generating Module** on open circuit and at rated speed.

ECP.A.5.2.2 The test shall be carried out prior to synchronisation in accordance with CP.6.4. This is not witnessed by **The Company** unless specifically requested by **The Company**. Where **The Company** is not witnessing the tests, the **Generator** shall supply the recordings of the following signals to **The Company** in an electronic spreadsheet format:

Vt - **Synchronous Generating Unit** terminal voltage  
Efd - **Synchronous Generating Unit** field voltage or main exciter field voltage  
Ifd- **Synchronous Generating Unit** field current (where possible)  
Step injection signal

ECP.A.5.2.3 Results shall be legible, identifiable by labelling, and shall have appropriate scaling.

ECP.A.5.3 Open & Short Circuit Saturation Characteristics

ECP.A.5.3.1 The test shall normally be carried out prior to synchronisation in accordance with ECP.6.2.4 or ECP.6.3.4 **Equipment Certificates** or **Manufacturer's Test Certificates** may be used where appropriate may be used if agreed by **The Company**.

- ECP.A.5.3.2 This is not witnessed by **The Company**. Graphical and tabular representations of the results in an electronic spreadsheet format showing per unit open circuit terminal voltage and short circuit current versus per unit field current shall be submitted to **The Company**.
- ECP.A.5.3.3 Results shall be legible, identifiable by labelling, and shall have appropriate scaling.
- ECP.A.5.4 **Excitation System On-Load Tests**
- ECP.A.5.4.1 The time domain performance of the **Excitation System** shall be tested by application of voltage step changes corresponding to 1% and 2% of the nominal terminal voltage.
- ECP.A.5.4.2 Where a **Power System Stabiliser** is present:
- (i) The **PSS** must only be commissioned in accordance with BC2.11.2. When a **PSS** is switched on for the first time as part of on-load commissioning or if parameters have been adjusted the **Generator** should consider reducing the **PSS** output gain by at least 50% and should consider reducing the limits on **PSS** output by at least a factor of 5 to prevent unexpected PSS action affecting the stability of the **Synchronous Generating Unit** or the **National Electricity Transmission System**.
  - (ii) The time domain performance of the **Excitation System** shall be tested by application of voltage step changes corresponding to 1% and 2% of the nominal terminal voltage, repeating with and without the **PSS** in service.
  - (iii) The frequency domain tuning of the **PSS** shall also be demonstrated by injecting a 0.2Hz-3Hz band limited random noise signal into the **Automatic Voltage Regulator** Setpoint with the **Synchronous Generating Unit** operating at points specified by **The Company** (up to rated MVA output).
  - (iv) The **PSS** gain margin shall be tested by increasing the **PSS** gain gradually to threefold and observing the **Synchronous Generating Unit** steady state **Active Power** output.
  - (v) The interaction of the **PSS** with changes in **Active Power** shall be tested by application of a +0.5Hz frequency injection to the governor while the **Synchronous Generating Unit** is selected to **Frequency Sensitive Mode**.
  - (vi) If the **Synchronous Power Generating Module** is of the **Pumped Storage** type then the step tests shall be carried out, with and without the **PSS**, in the pumping mode in addition to the generating mode. In the case of a **Synchronous Electricity Storage Module** the tests shall be carried out with and without the **PSS** in both importing and exporting modes of operation.
  - (vii) Where the **Bilateral Agreement** requires that the **PSS** is in service, at a specified loading level, additional testing witnessed by **The Company** will be required during the commissioning process before the **Synchronous Power Generating Module** may exceed this output level.
  - (viii) Where the **Excitation System** includes a **PSS**, the **Generator** shall provide a suitable noise source to facilitate noise injection testing.



ECP.A.5.4.3 The following typical procedure is provided to assist **Generators** in drawing up their own site specific procedures for **The Company** witnessed **PSS** Tests.

Test	Injection	Notes
	<b>Synchronous Generating Unit</b> running at <b>Maximum Capacity</b> , unity pf, PSS Switched Off	
1	<ul style="list-style-type: none"> <li>Record steady state for 10 seconds</li> <li>Inject +1% step to <b>AVR</b> voltage setpoint and hold for at least 10 seconds until stabilised</li> <li>Remove step returning <b>AVR</b> voltage setpoint to nominal and hold for at least 10 seconds</li> </ul>	
2	<ul style="list-style-type: none"> <li>Record steady state for 10 seconds</li> <li>Inject +2% step to <b>AVR</b> voltage setpoint and hold for at least 10 seconds until stabilised</li> <li>Remove step returning <b>AVR</b> voltage setpoint to nominal and hold for at least 10 seconds</li> </ul>	
3	<ul style="list-style-type: none"> <li>Inject band limited (0.2-3Hz) random noise signal into voltage Setpoint and measure frequency spectrum of <b>Real Power</b>.</li> <li>Remove noise injection.</li> </ul>	
	• Switch On Power System Stabiliser	
4	<ul style="list-style-type: none"> <li>Record steady state for 10 seconds</li> <li>Inject +1% step to <b>AVR</b> voltage setpoint and hold for at least 10 seconds until stabilised</li> <li>Remove step returning <b>AVR</b> voltage setpoint to nominal and hold for at least 10 seconds</li> </ul>	
5	<ul style="list-style-type: none"> <li>Record steady state for 10 seconds</li> <li>Inject +2% step to AVR Voltage Setpoint and hold for at least 10 seconds until stabilised</li> <li>Remove step returning AVR Voltage Setpoint to nominal and hold for at least 10 seconds</li> </ul>	
6	<ul style="list-style-type: none"> <li>Increase PSS gain at 30second intervals. i.e. x1 – x1.5 – x2 – x2.5 – x3</li> <li>Return PSS gain to initial setting</li> </ul>	
7	<ul style="list-style-type: none"> <li>Inject band limited (0.2-3Hz) random noise signal into voltage Setpoint and measure frequency spectrum of Real Power.</li> <li>Remove noise injection.</li> </ul>	
8	<ul style="list-style-type: none"> <li>Select the governor to FSM</li> <li>Inject +0.5 Hz step into governor.</li> <li>Hold until generator MW output is stabilised</li> <li>Remove step</li> </ul>	

ECP.A.5.5 **Under-excitation Limiter Performance Test**

ECP.A.5.5.1 Initially the performance of the **Under-excitation Limiter** should be checked by moving the limit line close to the operating point of the **Synchronous Generating Unit** when operating close to unity **Power Factor**. The operating point of the **Synchronous Generating Unit** is then stepped into the limit by applying a 2% decrease in **Automatic Voltage Regulator** Setpoint voltage.

ECP.A.5.5.2 The final performance of the **Under-excitation Limiter** shall be demonstrated by testing its response to a step change corresponding to a 2% decrease in **Automatic Voltage Regulator Setpoint** voltage when the **Synchronous Generating Unit** is operating just off the limit line, at the designed setting as indicated on the **Performance Chart** [P-Q Capability Diagram] submitted to **The Company** under OC2.

ECP.A.5.5.3 Where possible the **Under-excitation Limiter** should also be tested by operating the tap- changer when the **Synchronous Generating Unit** is

operating just off the limit line, as set up.

ECP.A.5.5.4 The **Under-excitation Limiter** will normally be tested at low active power output and at maximum **Active Power** output.

ECP.A.5.5.5 The following typical procedure is provided to assist **Generators** in drawing up their own site specific procedures for **The Company** witnessed **Under-excitation Limiter Tests**.

Test	Injection	Notes
	<b>Synchronous Generating Unit</b> running at <b>Maximum Capacity</b> and unity <b>Power Factor</b> . Under-excitation limit temporarily moved close to the operating point of the <b>Synchronous Generating Unit</b> .	
1	<ul style="list-style-type: none"> <li>• <b>PSS</b> on.</li> <li>• Inject -2% voltage step into <b>AVR</b> voltage setpoint and hold at least for 10 seconds until stabilised</li> <li>• Remove step returning <b>AVR</b> voltage setpoint to nominal and hold for at least 10 seconds</li> </ul>	
	Under-excitation limit moved to normal position. <b>Synchronous Generating Unit</b> running at <b>Maximum Capacity</b> and at leading <b>Reactive Power</b> close to Under-excitation limit.	
2	<ul style="list-style-type: none"> <li>• <b>PSS</b> on.</li> <li>• Inject -2% voltage step into <b>AVR</b> voltage setpoint and hold at least for 10 seconds until stabilised</li> <li>• Remove step returning <b>AVR</b> voltage setpoint to nominal and hold for at least 10 seconds</li> </ul>	

ECP.A.5.6 Over-excitation Limiter Performance Test

ECP.A.5.6.1 The performance of the **Over-excitation Limiter**, where it exists, shall be demonstrated by testing its response to a step increase in the **Automatic Voltage Regulator Setpoint Voltage** that results in operation of the **Over-excitation Limiter**. Prior to application of the step the **Synchronous Generating Unit** shall be generating **Maximum Capacity** and operating within its continuous **Reactive Power** capability. The size of the step will be determined by the minimum value necessary to operate the **Over-excitation Limiter** and will be agreed by **The Company** and the **Generator**. The resulting operation beyond the **Over-excitation Limit** shall be controlled by the **Over-excitation Limiter** without the operation of any protection that could trip the **Synchronous Power Generating Module**. The step shall be removed immediately on completion of the test.

ECP.A.5.6.2 If the **Over-excitation Limiter** has multiple levels to account for heating effects, an explanation of this functionality will be necessary and if appropriate, a description of how this can be tested.

ECP.A.5.6.3 The following typical procedure is provided to assist **Generators** in drawing up their own site specific procedures for **The Company** witnessed **Under-excitation Limiter Tests**.

Test	Injection	Notes
	<b>Synchronous Generating Unit</b> running at <b>Maximum Capacity</b> and maximum lagging <b>Reactive Power</b> .	
	Over-excitation Limit temporarily set close to this operating point. <b>PSS</b> on.	
1	• Inject positive voltage step into <b>AVR</b> voltage setpoint and	

	hold <ul style="list-style-type: none"> <li>• Wait until <b>Over-excitation Limiter</b> operates after sufficient time delay to bring back the excitation back to the limit.</li> <li>• Remove step returning <b>AVR</b> voltage setpoint to nominal.</li> </ul>	
	Over-excitation Limit restored to its normal operating value. <b>PSS</b> on.	

ECP.A.5.7 Reactive Capability

ECP.A.5.7.1 The **Reactive Power** capability on each **Synchronous Power Generating Module** will normally be demonstrated by:

- (a) operation of the **Synchronous Power Generating Module** at maximum lagging **Reactive Power** and **Maximum Capacity** for 1 hour
- (b) operation of the **Synchronous Power Generating Module** at maximum leading **Reactive Power** and **Maximum Capacity** for 1 hour.
- (c) operation of the **Synchronous Power Generating Module** at maximum lagging **Reactive Power** and **Minimum Stable Operating Level** for 1 hour
- (d) operation of the **Synchronous Power Generating Module** at maximum leading **Reactive Power** and **Minimum Stable Operating Level** for 1 hour.
- (e) operation of the **Synchronous Power Generating Module** at maximum lagging **Reactive Power** and a power output between **Maximum Capacity** and **Minimum Stable Operating Level**.
- (f) operation of the **Synchronous Power Generating Module** at maximum leading **Reactive Power** and a power output between **Maximum Capacity** and **Minimum Stable Operating Level**.

In the case of a **Synchronous Electricity Storage Module**, **The Company** shall have discretion to reduce the durations of the tests set out in ECP.A.5.7.1 (a) – (f), depending upon the capacity of the energy store.

ECP.A.5.7.2 In the case of an **Embedded Synchronous Power Generating Module** where distribution network considerations restrict the **Synchronous Power Generating Module Reactive Power** output, **The Company** will only require demonstration within the acceptable limits of the **Network Operator's System**.

ECP.A.5.7.3 The test procedure, time and date will be agreed with **The Company** and will be to the instruction of **The Company** control centre and shall be monitored and recorded at both **The Company** control centre and by the **Generator**.

ECP.A.5.7.4 Where the **Generator** is recording the voltage, **Active Power** and **Reactive Power** at the HV connection point the voltage for these tests **Active Power** and **Reactive Power** at the **Synchronous Power Generating Module** terminals may also be included. The results shall be supplied in an electronic spreadsheet format. Where applicable the **Synchronous Power Generating Module** transformer tapchanger position should be noted throughout the test period.

ECP.A.5.8 Governor and Load Controller Response Performance

ECP.A.5.8.1 The governor and load controller response performance will be tested by injecting simulated frequency deviations into the governor and load controller systems. Such simulated frequency deviation signals must be injected simultaneously at both speed governor and load controller setpoints. For **CCGT modules**, simultaneous injection into all gas turbines, steam turbine governors and module controllers is required.

ECP.A.5.8.2 Prior to witnessing the governor tests set out in ECP.A.5.8.6, **The Company** requires the **Generator** to conduct the preliminary tests detailed in ECP.A.5.8.4 and send the results to **The Company** for assessment unless agreed otherwise by **The Company**. The results should be supplied in an electronic spreadsheet format. These tests shall be completed at least two weeks prior to the witnessed governor response tests.

ECP.A.5.8.3 Where a **CCGT module** or **Synchronous Power Generating Module** is capable of operating on alternative fuels, tests will be required to demonstrate performance when operating on each fuel. **The Company** may agree a reduction from the tests listed in ECP.A.5.8.6 for demonstrating performance on the alternative fuel. This includes the case where a main fuel is supplemented by bio-fuel.

Preliminary Governor Frequency Response Testing

ECP.A.5.8.4 Prior to conducting the full set of tests as per ECP.A.5.8.6, **Generators** are required to conduct a preliminary set of tests below to confirm the frequency injection method is correct and the plant control performance is within expectation. The test numbers refer to Figure 1 below. With the plant running at 80% of full load, the following frequency injections shall be applied.

Test No (Figure1)	Frequency Injection	Notes
8	<ul style="list-style-type: none"> <li>• Inject -0.5Hz frequency fall over 10 sec</li> <li>• Hold for a further 20 sec</li> <li>• At 30 sec from the start of the test, Inject a +0.3Hz frequency rise over 30 sec.</li> <li>• Hold until conditions stabilise</li> <li>• Remove the injected signal as a ramp over 10 seconds</li> </ul>	
13	<ul style="list-style-type: none"> <li>• Inject - 0.5Hz frequency fall over 10 sec</li> <li>• Hold until conditions stabilise</li> <li>• Remove the injected signal as a ramp over 10 seconds</li> </ul>	
14	<ul style="list-style-type: none"> <li>• Inject +0.5Hz frequency rise over 10 sec</li> <li>• Hold until conditions stabilise</li> <li>• Remove the injected signal as a ramp over 10 seconds</li> </ul>	
H	<ul style="list-style-type: none"> <li>• Inject - 0.5Hz frequency fall as a stepchange</li> <li>• Hold until conditions stabilise</li> <li>• Remove the injected signal as a stepchange</li> </ul>	
I	<ul style="list-style-type: none"> <li>• Inject +0.5Hz frequency rise as a stepchange</li> <li>• Hold until conditions stabilise</li> <li>• Remove the injected signal as a stepchange</li> </ul>	

ECP.A.5.8.5 The recorded results (e.g. Finj, MW and control signals) should be sampled at a minimum rate of 1 Hz to allow **The Company** to assess the plant performance from the initial transients (seconds) to the final steady state conditions (5-15 minutes depending on the plant design). This is not witnessed by **The Company**. The **Generator** shall supply the recordings including data to **The Company** in an electronic spreadsheet format. Results shall be legible, identifiable by labelling, and shall have appropriate scaling.

Full Frequency Response Testing Schedule Witnessed by **The Company**

ECP.A.5.8.6 The tests are to be conducted at a number of different Module Load Points (MLP). The load points are conducted as shown below unless agreed otherwise by **The Company**.

Module Load Point 6 (Maximum Export Limit)	100% MEL
Module Load Point 5	95% MEL
Module Load Point 4 (Mid-point of Operating Range)	80% MEL
Module Load Point 3	70% MEL
Module Load Point 2 (Lower of MRL+10% or <b>Minimum Stable Operating Level</b> )	MRL+10% or MSOL
Module Load Point 1 ( <b>Minimum Regulating Level</b> )	MRL

ECP.A.5.8.7 The tests are divided into the following three types;

- (i) Frequency response compliance and volume tests as per ECP.A.5.8. Figure 1. These tests consist of frequency profile and ramp tests and adjustments to the target frequency setpoint as per ECP.5.8 Figure 3.
- (ii) System islanding and step response tests as shown by ECP.A.5.8. Figure 2.
- (iii) Frequency response tests in **Limited Frequency Sensitive Mode (LFSM)** to demonstrate **LFSM-O** and **LFSM-U** capability as shown by ECP.A.5.8 Figure 2.

ECP.A.5.8.8 There should be sufficient time allowed between tests for control systems to reach steady state. Where the diagram states 'HOLD' the current injection should be maintained until the **Active Power** (MW) output of the **Synchronous Power Generating Module** or **CCGT Module** has stabilised or 90 seconds, whichever is the longer. The frequency response capability test (see Figure 1) injection signal shall be returned to zero at the same rate at which it was applied. **The Company** may require repeat tests should the tests give unexpected results. When witnessed by **the Company** each test should be carried out as a separate injection, when not witnessed by **the Company** there must be sufficient time allowed between tests for the **Plant** to have reached a stable steady state operating condition or 90 seconds, whichever is the longer.

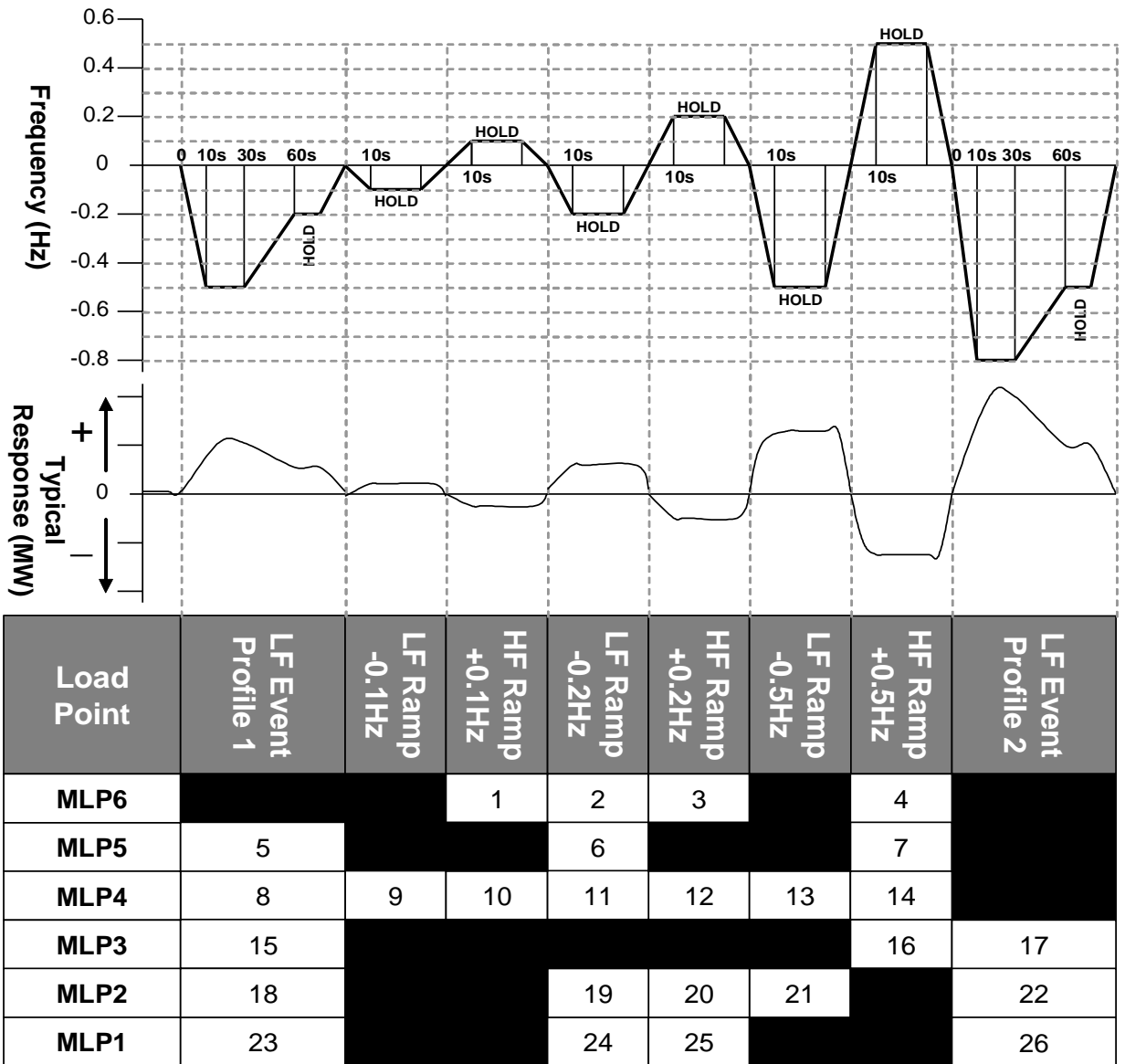

Figure 1: Frequency Response Capability FSM Ramp Response Tests

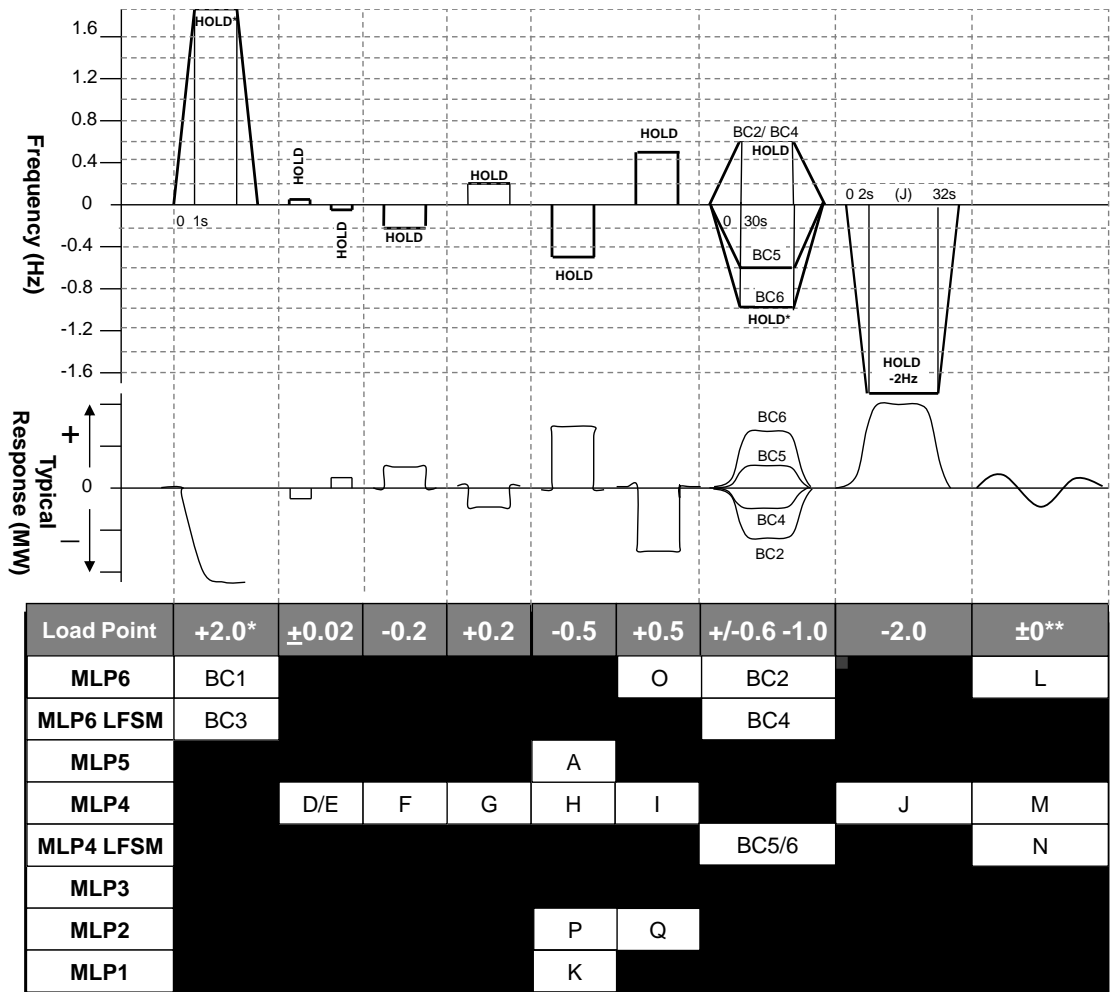

Figure 2: Frequency Response Capability LFSM-O, LFSM-U and FSM Step Response Tests

\* This will generally be +2.0Hz unless an injection of this size causes a reduction in plant output that takes the operating point below the **Minimum Regulating Level** in which case an appropriate injection should be calculated in accordance with the following:

For example, 0.9Hz is needed to take an initial output 65% to a final output of 20%. If the initial output was not 65% and the **Minimum Regulating Level** is not 20% then the injected step should be adjusted accordingly as shown in the example given below

Initial Output	65%
<b>Minimum Regulating Level</b>	20%
Frequency Controller Droop	4%
Frequency to be injected = $(0.65-0.20) \times 0.04 \times 50 =$	0.9Hz

\*\* Tests L and M in Figure 2 shall be conducted if in this range of tests the **System Frequency** feedback signal is replaced by the injection signal rather than the injection signal being added to the system frequency signal. The tests will consist of monitoring the **Synchronous Power Generating Module and CCGT Module** in **Frequency Sensitive Mode** during normal system frequency variations without applying any injection. Test N in figure 2 shall be

conducted in all cases. All three tests should be conducted for a period of at least 10 minutes.

ECP.A.5.8.9 The **Target Frequency** adjustment facility should be demonstrated from the normal control point within the range of 49.9Hz to 50.1Hz by step changes to the **Target Frequency** setpoint as indicated in ECP.A.5.8 Figure 3 while operating at MLP4.

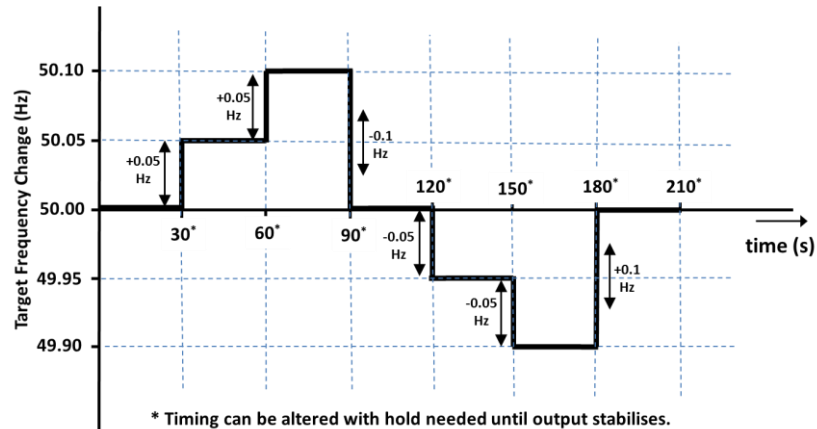

ECP.A.5.8 Figure 3 – Target Frequency setting changes

ECP.A.5.9 Compliance with ECC.6.3.3 Functionality Test

ECP.A.5.9.1 Where the plant design includes active control function or functions to deliver ECC.6.3.3 compliance, the **Generator** will propose and agree a test procedure with **The Company**, which will demonstrate how the **Synchronous Power Generating Module Active Power** output responds to changes in **System Frequency** and ambient conditions (e.g. by **Frequency** and temperature injection methods).

ECP.A.5.9.2 The **Generator** shall inform **The Company** if any load limiter control is additionally employed.

ECP.A.5.9.3 With the setpoint to the signals specified in ECP.A.4, **The Company** will agree with the **Generator** which additional control system parameters shall be monitored to demonstrate the functionality of ECC.6.3.3 compliance systems. Where **The Company** recording equipment is not used, results shall be supplied to **The Company** in an electronic spreadsheet format



## APPENDIX 6

### COMPLIANCE TESTING OF POWER PARK MODULES

#### ECP.A.6.1 SCOPE

ECP.A.6.1.1 This Appendix outlines the general testing requirements for **Power Park Modules** and **OTSDUA** to demonstrate compliance with the relevant aspects of the **Grid Code, Ancillary Services Agreement** and **Bilateral Agreement**. The tests specified in this Appendix will normally be sufficient to demonstrate compliance however **The Company** may:

- i) agree an alternative set of tests provided **The Company** deem the alternative set of tests sufficient to demonstrate compliance with the **Grid Code, Ancillary Services Agreement** and **Bilateral Agreement**; and/or
- ii) require additional or alternative tests if information supplied to **The Company** during the compliance process suggests that the tests in this Appendix will not fully demonstrate compliance with the relevant section of the **Grid Code, Ancillary Services Agreement** or **Bilateral Agreement**; and/or
- iii) require additional tests if a **Power System Stabiliser** is fitted; and/or
- iv) agree a reduced set of tests if a relevant **Manufacturer's Data & Performance Report** has been submitted to and deemed to be appropriate by **The Company**; and/or
- v) agree a reduced set of tests for subsequent **Power Park Modules** or **OTSDUA** following successful completion of the first **Power Park Module** or **OTSDUA** tests in the case of a **Power Station** comprised of two or more **Power Park Modules** or **OTSDUA** which **The Company** reasonably considers to be identical.

If:

- (a) the tests performed pursuant to ECP.A.6.1.1(iv) do not replicate the results contained in the **Manufacturer's Data & Performance Report**, or
- (b) the tests performed pursuant to ECP.A.6.1.1(v) in respect of subsequent **Power Park Modules** or **OTSDUA** do not replicate the full tests for the first **Power Park Module** or **OTSDUA**, or
- (c) any of the tests performed pursuant to ECP.A.6.1.1(iv) or ECP.A.6.1.1(v) do not fully demonstrate compliance with the relevant aspects of the **Grid Code, Ancillary Services Agreement** and / or **Bilateral Agreement**,

then notwithstanding the provisions above, the full testing requirements set out in this Appendix will be applied.

ECP.A.6.1.2 The **Generator** is responsible for carrying out the tests set out in and in accordance with this Appendix and the **Generator** retains the responsibility for the safety of personnel and plant during the test. **The Company** will witness all of the tests outlined or agreed in relation to this Appendix unless **The Company** decides and notifies the **Generator** otherwise. Reactive Capability tests may be witnessed by **The Company** remotely from **The Company** control centre. For all on site **The Company** witnessed tests the **Generator**

must ensure suitable representatives from the **Generator** and / or **Power Park Module** manufacturer (if appropriate) and/or **OTSDUA** manufacturer (if appropriate) are available on site for the entire testing period. In all cases and in addition to any recording of signals conducted by **The Company**, the **Generator** shall record all relevant test signals as outlined in ECP.A.4.

- ECP.A.6.1.3 In addition to the dynamic signals supplied in ECP.A.4 the **Generator** shall inform **The Company** of the following information prior to the commencement of the tests and any changes to the following, if any values change during the tests:
- (i) All relevant transformer tap numbers; and
  - (ii) Number of **Power Park Units** in operation
- ECP.A.6.1.4 The **Generator** shall submit a detailed schedule of tests to **The Company** in accordance with CP.6.3.1, and this Appendix.
- ECP.A.6.1.5 Prior to the testing of a **Power Park Module** or **OTSDUA**, the **Generator** shall complete the **Integral Equipment Tests** procedure in accordance with OC.7.5.
- ECP.A.6.1.6 Partial **Power Park Module** or **OTSDUA** testing as defined in ECP.A.6.2 and ECP.A.6.3 is to be completed at the appropriate stage in accordance with ECP.6, ECP6.4A, ECP6.4B.
- ECP.A.6.1.7 Full **Power Park Module** or **OTSDUA** testing as required by CP.7.2 is to be completed as defined in ECP.A.6.4 through to ECP.A.6.7.
- ECP.A.6.1.8 Where **OTSDUW Arrangements** apply and prior to the **OTSUA Transfer Time** any relevant **OTSDUW Plant and Apparatus** shall be considered within the scope of testing described in this Appendix. Performance shall be assessed against the relevant Grid Code requirements for **OTSDUW Plant and Apparatus** at the **Interface Point** and other **Generator Plant and Apparatus** at the **Offshore Grid Entry Point**. This Appendix should be read accordingly.
- ECP.A.6.1.9 **The Company** will permit relaxation from the requirement ECP.A.6.2 to ECP.A.6.8 where an **Equipment Certificate** for the **Power Park Module** has been provided which details the characteristics from tests on a representative installation with the same equipment and settings and the performance of the **Power Park Module** can, in **The Company's** opinion, reasonably represent that of the installed **Power Park Module** at that site. For **Type B, Type C** and **Type D Power Park Modules**, the relevant **Equipment Certificate** must be supplied in the **Power Generating Module Document** or **Users Data File structure** as applicable.
- ECP.A.6.1.10 In the case of a co-located site, for example **Electricity Storage Modules** or **Grid Forming Plant** connected within a new or existing **Power Station**, **The Company** will accept test results to demonstrate compliance at the **Grid Entry Point** or **User System Entry Point** (if **Embedded**) through a combination of the capabilities of the **Power Generating Modules** (which could include a **Grid Forming Plant**) and **Electricity Storage Modules** or **Electricity Storage Modules** (which could include a **Grid Forming Plant**) and **Generating Units** or **Power Park Modules**. **Generators** should however be aware that for the purposes of testing, full Grid Code compliance should be demonstrated when, for example, the **Electricity Storage Module** or **Grid Forming Plant** is out of service and the remaining **Power Generating Module** is in service or the **Electricity Storage Module** or **Grid Forming Plant** is in service and the **Power Generating Module** is out of service. In the case of a **Non-Synchronous**

**Electricity Storage Module, The Company** would expect the full set of tests to be completed as detailed in ECP.A.6.2 to ECP.A.6.8.

ECP.A.6.2 Pre 20% (or <50MW) Synchronised Power Park Module Basic Voltage Control Tests

ECP.A.6.2.1 Before 20% of the **Power Park Module** (or 50MW if less) has commissioned, either voltage control test ECP.A.6.5.6(i) or (ii) must be completed in accordance with ECP.6, ECP.6A or ECP.6B. In the case of an **Offshore Power Park Module** the test must be completed by the **Generator** undertaking **OTSDUW** or the **Offshore Transmission Licensee** under STCP19-5.

ECP.A.6.2.2 In the case of an **Offshore Power Park Module** which provides all or a portion of the **Reactive Power** capability as described in ECC.6.3.2.5.2 or ECP.6.3.2.6.3 and / or voltage control requirements as described in ECC.6.3.8.5 to enable an **Offshore Transmission Licensee** to meet the requirements of **STC** Section K, the **Generator** is required to cooperate with the **Offshore Transmission Licensee** to conduct the 20% voltage control test. The results in relation to the **Offshore Power Park Module** will be assessed against the requirements in the **Bilateral Agreement**.

ECP.A.6.3 Power Park Modules with Maximum Capacity  $\geq$ 100MW Pre 70% Power Park Module Tests

ECP.A.6.3.1 Before 70% but with at least 50% of the **Power Park Module** commissioned the following **Limited Frequency Sensitive** tests as detailed in ECP.A.6.6.2 must be completed.

- (a) BC3
- (b) BC4

ECP.A.6.4 Reactive Capability Test

ECP.A.6.4.1 This section details the procedure for demonstrating the reactive capability of an **Onshore Power Park Module** or an **Offshore Power Park Module** or **OTSDUA** which provides all or a portion of the **Reactive Power** capability as described in ECC.6.3.2.5.2 or ECP.6.3.2.6.3 as applicable (for the avoidance of doubt, an **Offshore Power Park Module** which does not provide part of the **Offshore Transmission Licensee Reactive Power** capability as described in ECC.6.3.2.5.1 and ECP.6.3.2.6.1 should complete the **Reactive Power** transfer / voltage control tests as per section ECP.A.6.8). These tests should be scheduled at a time where there are at least 95% of the **Power Park Units** within the **Power Park Module** in service. There should be sufficient MW resource forecasted in order to generate at least 85% of **Maximum Capacity** of the **Power Park Module**.

ECP.A.6.4.2 The tests shall be performed by modifying the voltage set-point of the voltage control scheme of the **Power Park Module** or **OTSDUA** by the amount necessary to demonstrate the required reactive range. This is to be conducted for the operating points and durations specified in ECP.A.6.4.5.

ECP.A.6.4.3 An **Embedded Generator** or **Embedded Generator** undertaking **OTSDUW** should liaise with the relevant **Network Operator** to ensure the following tests will not have an adverse impact upon the **Network Operator's System** as per OC.7.5. In situations where the tests have an adverse impact upon the **Network Operator's System**, **The Company** will only require demonstration within the acceptable limits of the **Network Operator**. For the avoidance of doubt, these tests do not negate the requirement to produce a complete **Power Park Module** or **OTSDUA** performance chart as specified in OC2.4.2.1

ECP.A.6.4.4 In the case where the **Reactive Power** metering point is not at the same location as the **Reactive Power** capability requirement, then an equivalent **Reactive Power** capability for the metering point shall be agreed between the **Generator** and **The Company**.

ECP.A.6.4.5 The following tests shall be completed:

- (i) Operation in excess of 60% **Maximum Capacity** and maximum continuous lagging **Reactive Power** for 30 minutes. For the avoidance of doubt this test must start with **Active Power** output in excess of 85% of **Maximum Capacity** of the **Power Park Module** as ECP.A.6.4.1 and must not fall below 60% of **Maximum Capacity** of the **Power Park Module** during the 30 minutes.
- (ii) Operation in excess of 60% **Maximum Capacity** and maximum continuous leading **Reactive Power** for 30 minutes. For the avoidance of doubt this test must start with **Active Power** output in excess of 85% of **Maximum Capacity** of the **Power Park Module** as ECP.A.6.4.1 and must not fall below 60% of **Maximum Capacity** of the **Power Park Module** during the 30 minutes.
- (iii) Operation at 50% **Maximum Capacity** and maximum continuous leading **Reactive Power** for 30 minutes.
- (iv) Operation at 50% **Maximum Capacity** and maximum continuous lagging **Reactive Power** for 30 minutes.
- (v) Operation at 20% **Maximum Capacity** and maximum continuous leading **Reactive Power** for 60 minutes.
- (vi) Operation at 20% **Maximum Capacity** and maximum continuous lagging **Reactive Power** for 60 minutes.
- (vii) Operation at less than 20% **Maximum Capacity** and unity **Power Factor** for 5 minutes. This test only applies to systems which do not offer voltage control below 20% of **Maximum Capacity**.
- (viii) Operation at the lower of the **Minimum Regulating Level** or 0% **Maximum Capacity** and maximum continuous leading **Reactive Power** for 5 minutes. This test only applies to systems which offer voltage control below 20% and hence establishes actual capability rather than required capability.
- (ix) Operation at the lower of the **Minimum Regulating Level** or 0% **Maximum Capacity** and maximum continuous lagging **Reactive Power** for 5 minutes. This test only applies to systems which offer voltage control below 20% and hence establishes actual capability rather than required capability.

In the case of a **Non-Synchronous Electricity Storage Module**, **The Company** shall have discretion to reduce the duration of the tests required in ECP.A.6.4.5 (i) – (viii) depending upon the capability of the energy store.

ECP.A.6 Within this ECP, lagging **Reactive Power** is the export of **Reactive Power** from the **Power Park Module** to the **Total System** and leading **Reactive Power** is the import of **Reactive Power** from the **Total System** to the **Power Park Module** or **OTSDUA**.

ECP.A.6.5 Voltage Control Tests

- ECP.A.6.5.1 This section details the procedure for conducting voltage control tests on **Onshore Power Park Modules** or **OTSDUA** or an **Offshore Power Park Module** which provides all or a portion of the voltage control capability as described in ECC.6.3.8.5 (for the avoidance of doubt, **Offshore Power Park Modules** which do not provide part of the **Offshore Transmission Licensee** voltage control capability as described in CC6.3.8.5 should complete the **Reactive Power** transfer / voltage control tests as per section ECP.A.6.8). These tests should be scheduled at a time when there are at least 95% of the **Power Park Units** within the **Power Park Module** in service. There should be sufficient MW resource forecasted in order to generate at least 65% of **Maximum Capacity** of the **Onshore Power Park Module**. An **Embedded Generator** or **Embedded Generators** undertaking **OTSDUW** should also liaise with the relevant **Network Operator** to ensure all requirements covered in this section will not have a detrimental effect on the **Network Operator's System**.
- ECP.A.6.5.2 The voltage control system shall be perturbed with a series of step injections to the **Power Park Module** voltage setpoint, and where possible, multiple up-stream transformer taps. In the case of an **Offshore Power Park Module** providing part of the **Offshore Transmission Licensee** voltage control capability this may require a series of step injections to the voltage setpoint of the **Offshore Transmission Licensee** control system.
- ECP.A.6.5.3 For steps initiated using network tap changers, the **Generator** will need to coordinate with **The Company** or the relevant **Network Operator** as appropriate. The time between transformer taps shall be at least 10 seconds as per ECP.A.6.5 Figure 1.
- ECP.A.6.5.4 For a step injection into the **Power Park Module** or **OTSDUA** voltage setpoint, steps of  $\pm 1\%$ ,  $\pm 2\%$  and  $\pm 4\%$  (or larger if required by **The Company**) shall be applied to the voltage control system setpoint summing junction. The injection shall be maintained for a minimum of 10 seconds as per ECP.A.6.5 Figure 2.
- ECP.A.6.5.5 Where the voltage control system comprises of discretely switched **Plant** and **Apparatus** (eg. mechanically switched shunt reactors or capacitors) additional tests will be required to demonstrate that overall performance of the voltage control system when switching these devices as part of the response is in accordance with **Grid Code** and **Bilateral Agreement** requirements.
- ECP.A.6.5.6 Tests to be completed:

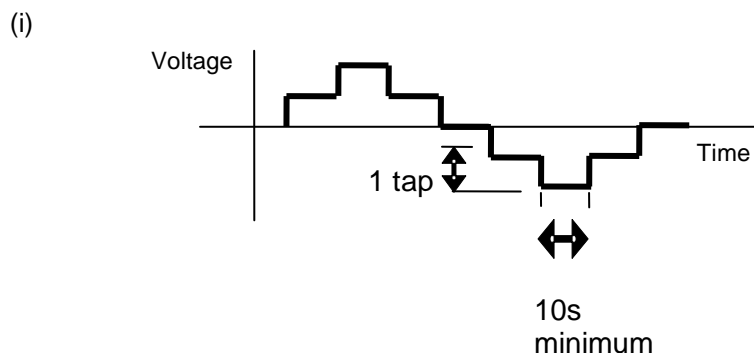

ECP.A.6.5 Figure 1 – Transformer tap sequence for voltage control tests

(ii)

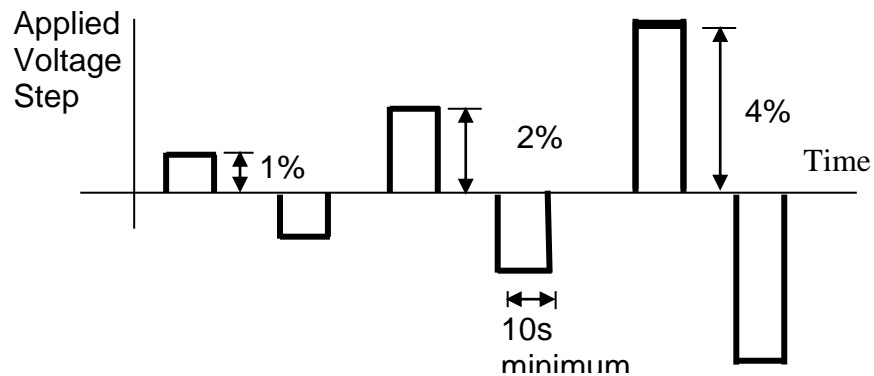

ECP.A.6.5 Figure 2 – Step injection sequence for voltage control tests

ECP.A.6.5.7 In the case of **OTSDUA**, where the **Bilateral Agreement** specifies additional damping facilities, additional testing to demonstrate these damping facilities may be required.

ECP.A.6.5.8 In the case of **Power Park Modules** that do not provide voltage control down to zero **Active Power** a test to demonstrate the smooth transition from voltage control mode to unity **Power Factor** shall be carried out. The **Power Park Module** voltage setpoint should be altered to produce lagging **Reactive Power** or absorbing leading **Reactive Power** at a low **Active Power** level where voltage control is provided. The **Power Park Module Active Power** should then be reduced to zero **Active Power** as a ramp over a short period (60 seconds is suggested).

#### ECP.A.6.6 Frequency Response Tests

ECP.A.6.6.1 This section describes the procedure for performing frequency response testing on a **Power Park Module**. These tests should be scheduled at a time where there are at least 95% of the **Power Park Units** within the **Power Park Module** in service. There should be sufficient MW resource forecasted in order to generate at least 65% of **Maximum Capacity** of the **Power Park Module**.

ECP.A.6.6.2 The frequency controller shall be in **Frequency Sensitive Mode** or **Limited Frequency Sensitive Mode** as appropriate for each test. Simulated frequency deviation signals shall be injected into the frequency controller setpoint/feedback summing junction. If the injected frequency signal replaces rather than sums with the real **System Frequency** signal then the additional tests outlined in ECP.A.6.6.6 shall be performed with the **Power Park Module** or **Power Park Unit** in normal **Frequency Sensitive Mode** monitoring actual **System Frequency**, over a period of at least 10 minutes. The aim of this additional test is to verify that the control system correctly measures the real **System Frequency** for normal variations over a period of time.

ECP.A.6.6.3 In addition to the frequency response requirements it is necessary to demonstrate the **Power Park Module** ability to deliver a requested steady state power output which is not impacted by power source variation as per ECC.6.3.9. This test shall be conducted in **Limited Frequency Sensitive Mode** at a part-loaded output for a period of 10 minutes as per ECP.A.6.6.6.

#### Preliminary Frequency Response Testing

ECP.A.6.6.4 Prior to conducting the full set of tests as per ECP.A.6.6.6, **Generators** are

required to conduct the preliminary set of tests below to confirm the frequency injection method is correct and the plant control performance is within expectation. The test numbers refer to Figure 1 below. The test should be conducted when sufficient MW resource is forecast in order to generate at least 65% of **Maximum Capacity** of the **Power Park Module**. The following frequency injections shall be applied when operating at module load point 4.

Test No (Figure1)	Frequency Injection	Notes
8	<ul style="list-style-type: none"> <li>Inject -0.5Hz frequency fall over 10 sec</li> <li>Hold for a further 20 sec</li> <li>At 30 sec from the start of the test, Inject a +0.3Hz frequency rise over 30 sec.</li> <li>Hold until conditions stabilise</li> <li>Remove the injected signal as a ramp over 10 seconds</li> </ul>	
13	<ul style="list-style-type: none"> <li>Inject - 0.5Hz frequency fall over 10 sec</li> <li>Hold until conditions stabilise</li> <li>Remove the injected signal as a ramp over 10 seconds</li> </ul>	
14	<ul style="list-style-type: none"> <li>Inject +0.5Hz frequency rise over 10 sec</li> <li>Hold until conditions stabilise</li> <li>Remove the injected signal as a ramp over 10 seconds</li> </ul>	
H	<ul style="list-style-type: none"> <li>Inject - 0.5Hz frequency fall as a stepchange</li> <li>Hold until conditions stabilise</li> <li>Remove the injected signal as a stepchange</li> </ul>	
I	<ul style="list-style-type: none"> <li>Inject +0.5Hz frequency rise as a stepchange</li> <li>Hold until conditions stabilise</li> <li>Remove the injected signal as a stepchange</li> </ul>	

ECP.A.6.6.5 The recorded results (e.g. Finj, MW and control signals) should be sampled at a minimum rate of 1 Hz to allow **The Company** to assess the plant performance from the initial transients (seconds) to the final steady state conditions (5-15 minutes depending on the plant design). This is not witnessed by **The Company**. The **Generator** shall supply the recordings including data to **The Company** in an electronic spreadsheet format. Results shall be legible, identifiable by labelling, and shall have appropriate scaling.

Full Frequency Response Testing Schedule Witnessed by **The Company**.

ECP.A.6.6.6 The tests are to be conducted at a number of different Module Load Points (MLP). In the case of a **Power Park Module** the module load points are conducted as shown below unless agreed otherwise by **The Company**.

Module Load Point 6 (Maximum Export Limit)	100% MEL
Module Load Point 5	90% MEL
Module Load Point 4	80% MEL
Module Load Point 3	MRL+0.6 x (MEL – MRL)
Module Load Point 2 Lower of MRL + 0.3 x (MEL – MRL) or <b>Minimum Stable Operating Level</b>	MRL+0.3 X (MEL – MRL) or MSOL
Module Load Point 1 (Minimum Regulating Level)	MRL

ECP.A.6.6.7 The tests are divided into the following two types;

- (i) Frequency response compliance and volume tests as per ECP.A.6.6. Figure 1. These tests consist of frequency profile and ramp tests and adjustments to target frequency setpoint as per ECP.A.6.6 Figure 3.

- (ii) System islanding and step response tests as shown by ECP.A.6.6. Figure 2.
- (iii) Frequency response tests in **Limited Frequency Sensitive Mode (LFSM)** to demonstrate **LFSM-O** and **LFSM-U** capability as shown by ECP.A.6.6 Figure 2.

ECP.A.6.6.8 There should be sufficient time allowed between tests for control systems to reach steady state (depending on available power resource). Where the diagram states 'HOLD' the current injection should be maintained until the **Active Power (MW)** output of the **Power Park Module** has stabilised or 90 seconds, whichever is the longer. All frequency response tests should be removed over the same timescale for which they were applied. **The Company** may require repeat tests should the response volume be affected by the available power, or if tests give unexpected results. When witnessed by **The Company** each test should be carried out as a separate injection, when not witnessed by **The Company** there must be sufficient time allowed between tests for the **Active Power (MW)** output of the **Power Park Module** to have stabilised or 90 seconds, whichever is the longer.

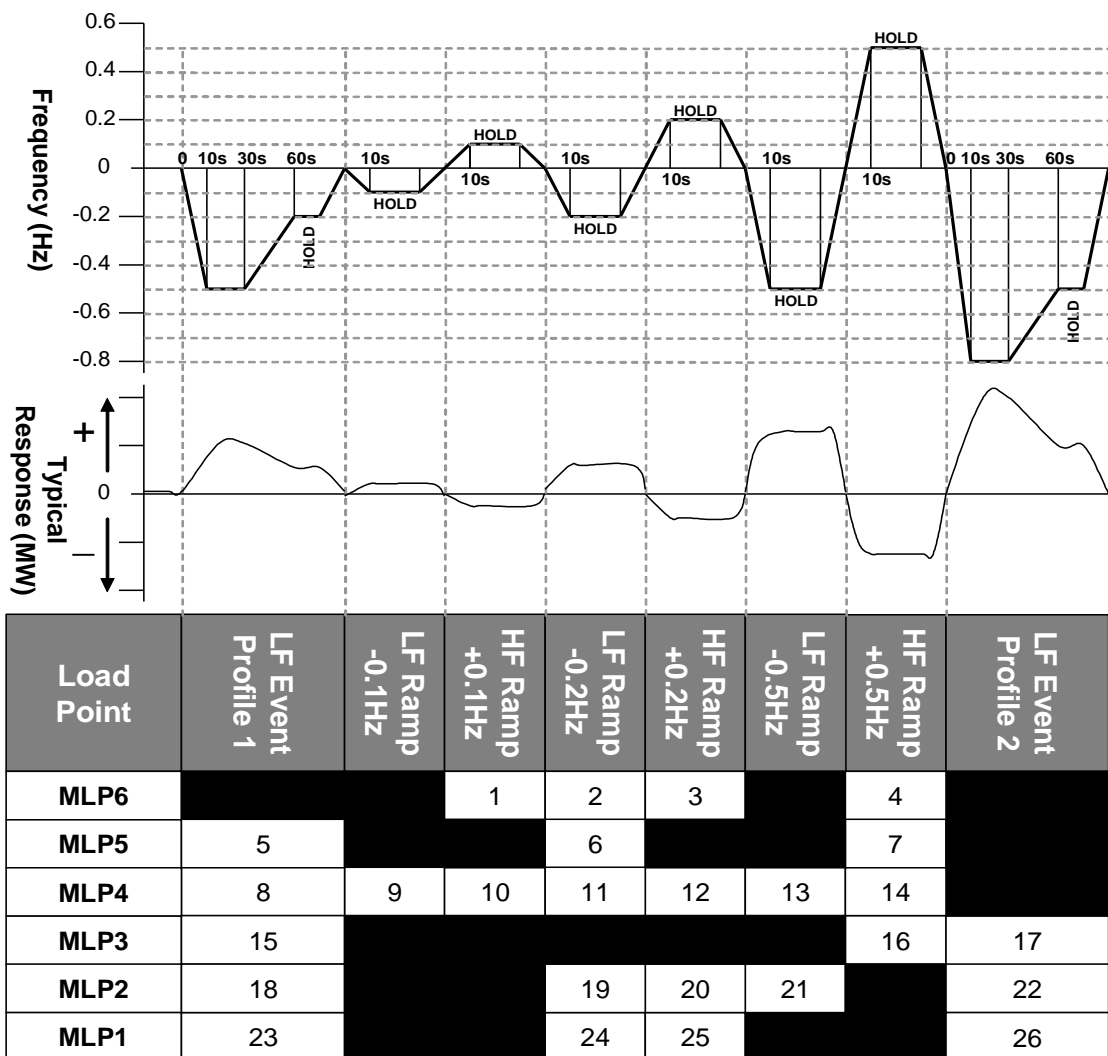

ECP.A.6.6. Figure 1 – Frequency Response Capability FSM Ramp Response tests



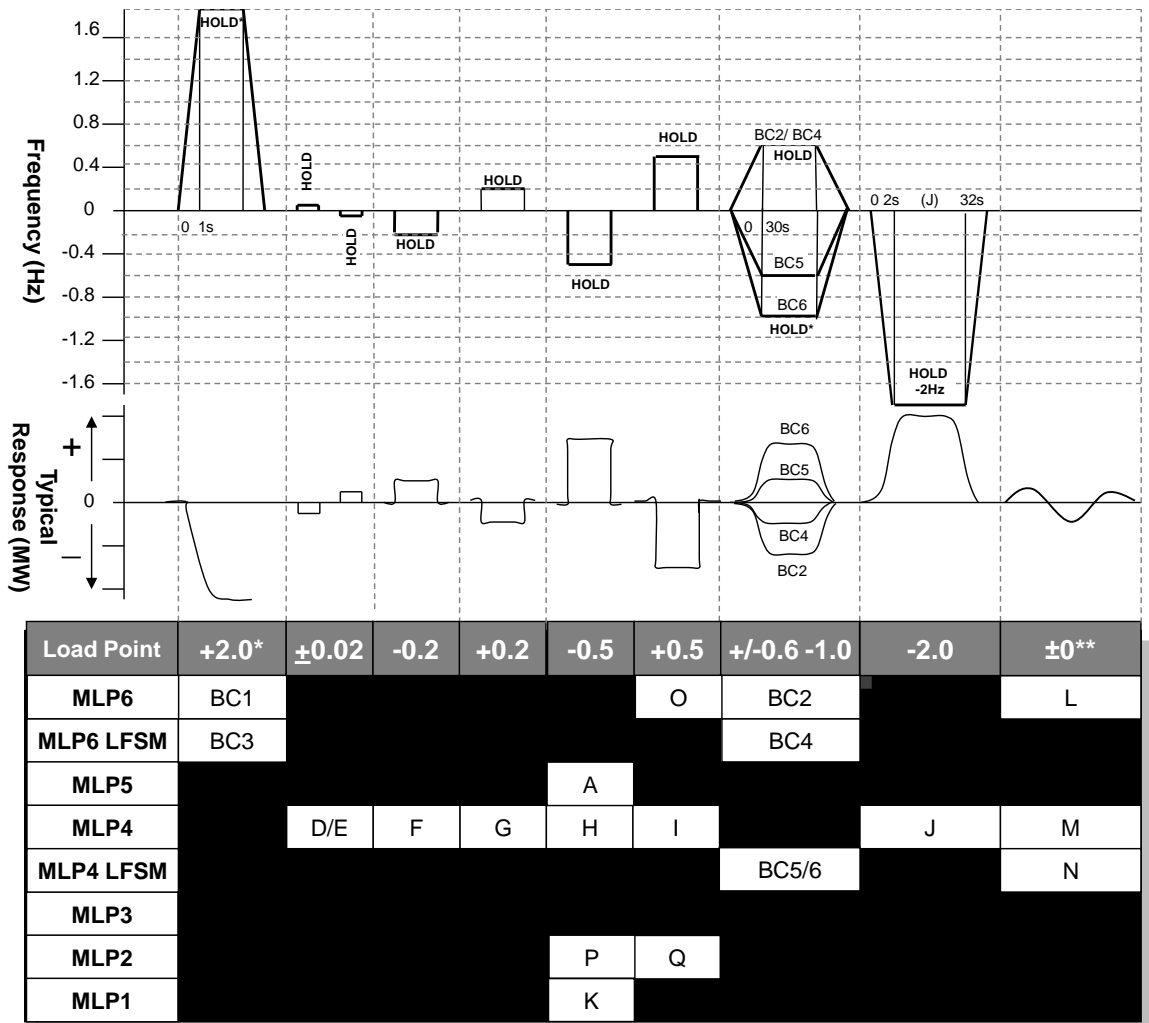

ECP.A.6.6. Figure 2 – Frequency Response Capability LFSM-O, LFSM-U, FSM Step Response tests

\* This will generally be +2.0Hz unless an injection of this size causes a reduction in plant output that takes the operating point below the **Minimum Regulating Level** in which case an appropriate injection should be calculated in accordance with the following:

For example 0.9Hz is needed to take an initial output 65% to a final output of 20%. If the initial output was not 65% and the **Minimum Regulating Level** is not 20% then the injected step should be adjusted accordingly as shown in the example given below

Initial Output	65%
<b>Minimum Regulating Level</b>	20%
Frequency Controller Droop	4%
Frequency to be injected = $(0.65-0.20) \times 0.04 \times 50 =$	0.9Hz

\*\* Tests L and M in Figure 2 shall be conducted if in this range of tests the **System Frequency** feedback signal is replaced by the injection signal rather than the injection signal being added to the system frequency signal. The tests will consist of monitoring the **Power Park Module** in **Frequency Sensitive Mode** during normal **System Frequency** variations without applying any injection. Test N in Figure 2 shall be conducted in all cases. All three tests should be conducted for a period of at least 10 minutes.

ECP.A.6.6.9 The **Target Frequency** adjustment facility should be demonstrated from the

normal control point within the range of 49.9Hz to 50.1Hz by step changes to the **Target Frequency** setpoint as indicated in ECP.A.6.6 Figure 3 while operating at MLP4.

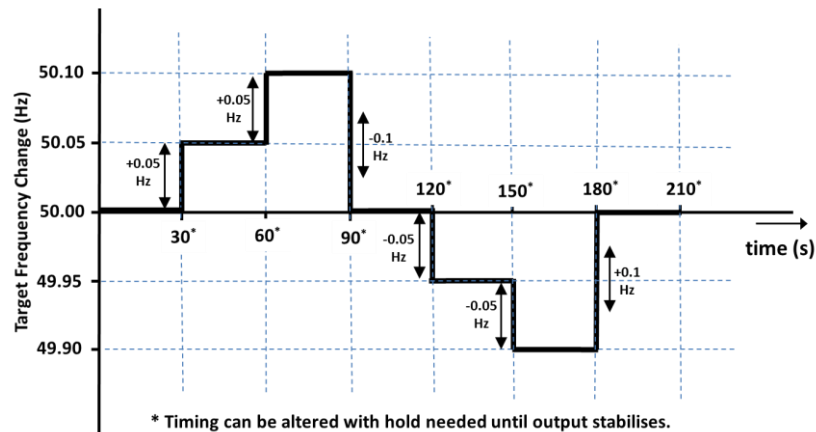

ECP.A.6.6. Figure 3 – **Target Frequency** setting changes

#### ECP.A.6.7 Fault Ride Through Testing

ECP.A.6.7.1 This section describes the procedure for conducting **Fault Ride Through** tests on a single **Power Park Unit** as required by ECP.7.2.2(d).

ECP.A.6.7.2 The test circuit will utilise the full **Power Park Unit** (e.g. in the case of a wind turbine it would include the full wind turbine nacelle structure, all inverters and converters along with step up transformer to medium voltage, all control systems including pitch control emulation) and shall be conducted with sufficient power input resource available to produce at least 95% of the **Maximum Capacity** of the **Power Park Unit**. The test will comprise of a number of controlled short circuits applied to a test network to which the **Power Park Unit** is connected, typically comprising of the **Power Park Unit** transformer and a test impedance or other decoupling equipment to shield the connected network from voltage dips at the **Power Park Unit** terminals.

ECP.A.6.7.3 In each case, the tests should demonstrate the minimum voltage at the **Power Park Unit** terminals or **High Voltage** side of the **Power Park Unit** transformer which the **Power Park Unit** can withstand for the length of time specified in ECP.A.6.7.5. Any test results provided to **The Company** should contain sufficient data pre and post fault in order to determine steady state values of all signals, and the power recovery timescales.

ECP.A.6.7.4 In addition to the signals outlined in ECP.A.4.2. the following signals from either the **Power Park Unit** terminals or **High Voltage** side of the **Power Park Unit** transformer should be provided for this test only:

- (i) Phase voltages
- (ii) Positive phase sequence and negative phase sequence voltages
- (iii) Phase currents
- (iv) Positive phase sequence and negative phase sequence currents
- (v) Estimate of **Power Park Unit** negative phase sequence impedance
- (vi) MW – **Active Power** at the **Power Generating Module**.
- (vii) MVar – **Reactive Power** at the **Power Generating Module**.
- (viii) Mechanical Rotor Speed
- (ix) Real / reactive, current / power Setpoint as appropriate
- (x) **Fault Ride Through** protection operation (e.g. a crowbar in the case of a doubly fed induction generator)

- (xi) Any other signals relevant to the control action of the **Fault Ride Through** control deemed applicable for model validation.

At a suitable frequency rate for fault ride through tests as agreed with **The Company**.

- ECP.A.6.7.5 The tests should be conducted for the times and fault types indicated in ECC.6.3.15 as applicable.
- ECP.A.6.8 Reactive Power Transfer / Voltage Control Tests for **Offshore Power Park Modules**
- ECP.A.6.8.1 In the case of an **Offshore Power Park Module** which provides all or a portion of the **Reactive Power** capability as described in ECP.6.3.2.5.2 or ECP.6.3.6.3 and / or voltage control requirements as described in ECC.6.3.8.5 to enable an **Offshore Transmission Licensee** to meet the requirements of **STC** Section K, the testing, will comprise of the entire control system responding to changes at the onshore **Interface Point**. Therefore, the tests in this section ECP.A.6.8 will not apply. The **Generator** shall cooperate with the relevant **Offshore Transmission Licensee** to facilitate these tests as required by **The Company**. The testing may be combined with testing of the corresponding **Offshore Transmission Licensee** requirements under the **STC**. The results in relation to the **Offshore Power Park Module** will be assessed against the requirements in the **Bilateral Agreement**.
- ECP.A.6.8.2 In the case of an **Offshore Power Park Module** which does not provide part of the **Offshore Transmission Licensee Reactive Power** capability the following procedure for conducting **Reactive Power** transfer control tests on **Offshore Power Park Modules** and / or voltage control system as per ECC.6.3.2.5 and ECC.6.3.2.6 apply. These tests should be carried out prior to 20% of the **Power Park Units** within the **Offshore Power Park Module** being synchronised, and again when at least 95% of the **Power Park Units** within the **Offshore Power Park Module** in service. There should be sufficient power resource forecast to generate at least 85% of the **Maximum Capacity** of the **Offshore Power Park Module**.
- ECP.A.6.8.3 The **Reactive Power** control system shall be perturbed by a series of system voltage changes and changes to the **Active Power** output of the **Offshore Power Park Module**.
- ECP.A.6.8.4 **System** voltage changes should be created by a series of multiple upstream transformer taps. The **Generator** should coordinate with **The Company** or the relevant **Network Operator** in order to conduct the required tests. The time between transformer taps should be at least 10 seconds as per ECP.A.6.8 Figure 1.
- ECP.A.6.8.5 The **Active Power** output of the **Offshore Power Park Module** should be varied by applying a sufficiently large step to the frequency controller Setpoint/feedback summing junction to cause a 10% change in output of the **Maximum Capacity** of the **Offshore Power Park Module** in a time not exceeding 10 seconds. This test does not need to be conducted provided that the frequency response tests as outlined in ECP.A.6.6 are completed.
- ECP.A.6.8.6 The following diagrams illustrate the tests to be completed:

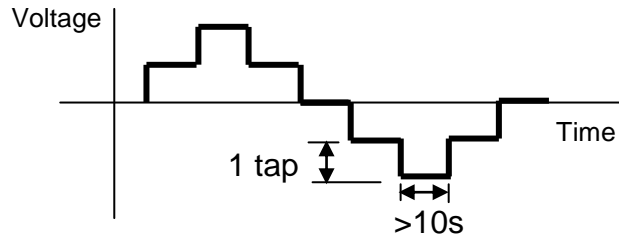

ECP.A.6.8 Figure 1 – Transformer tap sequence for reactive transfer tests

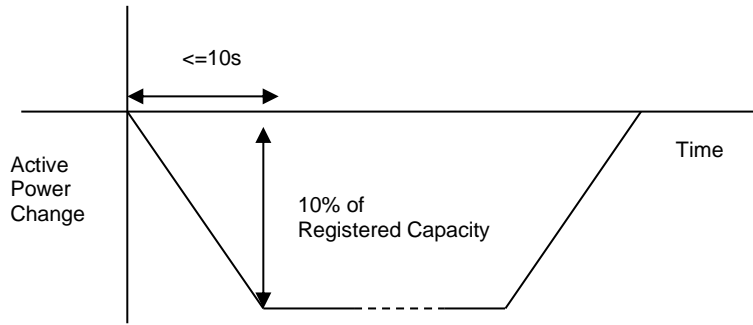

ECP.A.6.8 Figure 2 – **Active Power** ramp for reactive transfer tests

## APPENDIX 7

### COMPLIANCE TESTING FOR HVDC EQUIPMENT

#### ECP.A.7.1 SCOPE

ECP.A.7.1.1 This Appendix outlines the general testing requirements for **HVDC System Owners** to demonstrate compliance with the relevant aspects of the **Grid Code, Ancillary Services Agreement** and **Bilateral Agreement**. The tests specified in this Appendix will normally be sufficient to demonstrate compliance however **The Company** may:

- i) agree an alternative set of tests provided **The Company** deem the alternative set of tests sufficient to demonstrate compliance with the **Grid Code, Ancillary Services Agreement** and **Bilateral Agreement**; and/or
- ii) require additional or alternative tests if information supplied to **The Company** during the compliance process suggests that the tests in this Appendix will not fully demonstrate compliance with the relevant section of the **Grid Code, Ancillary Services Agreement** or **Bilateral Agreement**; and/or
- iii) require additional tests if control functions to improve damping of power system oscillations and/or subsynchronous resonance torsional oscillations required by the **Bilateral Agreement** or included in the control scheme and active; and/or
- iv) agree a reduced set of tests for subsequent **HVDC Equipment** following successful completion of the first **HVDC Equipment** tests in the case of an installation comprising of two or more **HVDC Systems** or **DC Connected Power Park Modules** which **The Company** reasonably considers to be identical.

If:

- (a) the tests performed pursuant to ECP.A.7.1.1(iv) in respect of subsequent **HVDC Systems** or **DC Connected Power Park Modules** do not replicate the full tests for the first **HVDC Equipment**, or
- (b) any of the tests performed pursuant to ECP.A.7.1.1(iv) do not fully demonstrate compliance with the relevant aspects of the **Grid Code, Ancillary Services Agreement** and / or **Bilateral**

ECP.A.7.1.2 The **HVDC System Owner** is responsible for carrying out the tests set out in and in accordance with this Appendix and the **HVDC System Owner** retains the responsibility for the safety of personnel and plant during the test. The **HVDC System Owner** is responsible for ensuring that suitable arrangements are in place with the **Externally Interconnected System Operator** to facilitate testing. **The Company** will witness all of the tests outlined or agreed in relation to this Appendix unless **The Company** decides and notifies the **HVDC System Owner** otherwise. Reactive Capability tests if required, may be witnessed by **The Company** remotely from **The Company** control centre. For all on site at **The Company** witnessed tests, the **HVDC System Owner** must ensure suitable representatives from the **HVDC System Owner** and / or **HVDC Equipment** manufacturer (if appropriate) are available on site for the entire testing period. In all cases and in addition to any recording of signals conducted by **The Company**, the **HVDC System Owner** shall record all relevant test signals as outlined in ECP.A.4.

- ECP.A.7.1.3 In addition to the dynamic signals supplied in ECP.A.4 the **HVDC System Owner** shall inform **The Company** of the following information prior to the commencement of the tests and any changes to the following, if any values change during the tests:
- (i) All relevant transformer tap numbers.
- ECP.A.7.1.4 The **HVDC System Owner** shall submit a detailed schedule of tests to **The Company** in accordance with CP.6.3.1, and this Appendix.
- ECP.A.7.1.5 Prior to the testing of **HVDC Equipment**, the **HVDC System Owner** shall complete the **Integral Equipment Tests** procedure in accordance with OC.7.5.
- ECP.A.7.1.6 Full **HVDC Equipment** testing as required by ECP.7.2 is to be completed as defined in ECP.A.7.2 through to ECP.A.7.5.
- ECP.A.7.1.7 **The Company** will permit relaxation from the requirement ECP.A.7.2 to ECP.A.7.5 where an **Equipment Certificate for HVDC Equipment** has been provided which details the characteristics from tests on a representative installation with the same equipment and settings and the performance of the **HVDC Equipment** can, in **The Company's** opinion, reasonably represent that of the installed **HVDC Equipment** at that site. The relevant **Equipment Certificate** must be supplied in the **Users Data File structure**.
- ECP.A.7.1.8 **The Company** may agree a reduction from the requirement ECP.A.7.2 to ECP.A.7.5 for on-site testing where suitable factory acceptance testing on a representative installation with the same equipment and settings of the **HVDC Equipment** that can, in **The Company's** opinion, reasonably represent the performance of the installed **HVDC Equipment** at that site. This is also conditional on **The Company** and the **DC Converter Station** owner agreeing sufficient on site testing of the fully commissioned **DC Converter Station** to demonstrate that the factory acceptance tests are valid. If in the reasonable opinion of **The Company**, the on-site testing does not demonstrate the factory acceptance tests are valid then the full set of on-site tests should be carried out.
- ECP.A.7.2 Reactive Capability Test
- ECP.A.7.2.1 This section details the procedure for demonstrating the reactive capability of **HVDC Equipment**. These tests should be scheduled at a time where there are sufficient MW resource forecasted in order to import and export full **Maximum Capacity** of the **HVDC Equipment**.
- ECP.A.7.2.2 The tests shall be performed by modifying the voltage set-point of the voltage control scheme of the **HVDC Equipment** by the amount necessary to demonstrate the required reactive range. This is to be conducted for the operating points and durations specified in ECP.A.7.2.5.
- ECP.A.7.2.3 **Embedded HVDC System Owners** should liaise with the relevant **Network Operator** to ensure the following tests will not have an adverse impact upon the **Network Operator's System** as per OC.7.5. In situations where the tests have an adverse impact upon the **Network Operator's System**, **The Company** will only require demonstration within the acceptable limits of the **Network Operator**. For the avoidance of doubt, these tests do not negate the requirement to produce a complete **HVDC Equipment** performance chart as specified in OC2.4.2.1
- ECP.A.7.2.4 In the case where the **Reactive Power** metering point is not at the same

location as the **Reactive Power** capability requirement, then an equivalent **Reactive Power** capability for the metering point shall be agreed between the **HVDC System Owner** and **The Company**.

ECP.A.7.2.5 The following tests shall be completed for both importing and exporting of **Active Power** for a **DC Converter**:

- (i) Operation at **Maximum Capacity** and maximum continuous lagging **Reactive Power** for 60 minutes.
- (ii) Operation at **Maximum Capacity** and maximum continuous leading **Reactive Power** for 60 minutes.
- (iii) Operation at 50% **Maximum Capacity** and maximum continuous leading **Reactive Power** for 60 minutes.
- (iv) Operation at 50% **Maximum Capacity** and maximum continuous lagging **Reactive Power** for 60 minutes.
- (v) Operation at **Minimum Capacity** and maximum continuous leading **Reactive Power** for 60 minutes.
- (vi) Operation at **Minimum Capacity** and maximum continuous lagging **Reactive Power** for 60 minutes.

ECP.A.7.2.6 For the avoidance of doubt, lagging **Reactive Power** is the export of **Reactive Power** from the **HVDC Equipment** to the **Total System** and leading **Reactive Power** is the import of **Reactive Power** from the **Total System** to the **HVDC Equipment**.

ECP.A.7.3 Not used

ECP.A.7.4 Voltage Control Tests

ECP.A.7.4.1 This section details the procedure for conducting voltage control tests on **HVDC Equipment**. These tests should be scheduled at a time where there is sufficient MW resource in order to import and export **Maximum Capacity** of the **HVDC Equipment**. An **Embedded HVDC System Owner** should also liaise with the relevant **Network Operator** to ensure all requirements covered in this section will not have a detrimental effect on the **Network Operator's System**.

ECP.A.7.4.2 The voltage control system shall be perturbed with a series of step injections to the **HVDC Equipment** voltage Setpoint, and where possible, multiple up-stream transformer taps.

ECP.A.7.4.3 For steps initiated using network tap changers the **HVDC System Owner** will need to coordinate with **The Company** or the relevant **Network Operator** as appropriate. The time between transformer taps shall be at least 10 seconds as per ECP.A.7.4 Figure 1.

ECP.A.7.4.4 For step injection into the **HVDC Equipment** voltage setpoint, steps of  $\pm 1\%$ ,  $\pm 2\%$  and  $\pm 4\%$  shall be applied to the voltage control system setpoint summing junction. The injection shall be maintained for 10 seconds as per ECP.A.7.4 Figure 2.

ECP.A.7.4.5 Where the voltage control system comprises of discretely switched plant and apparatus, additional tests will be required to demonstrate that its performance is in accordance with **Grid Code** and **Bilateral Agreement** requirements.

ECP.A.7.4.6 Tests to be completed:

(i)

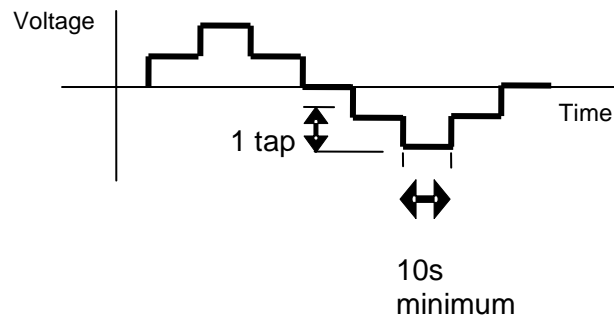

ECP.A.7.4 Figure 1 – Transformer tap sequence for voltage control tests



(ii)

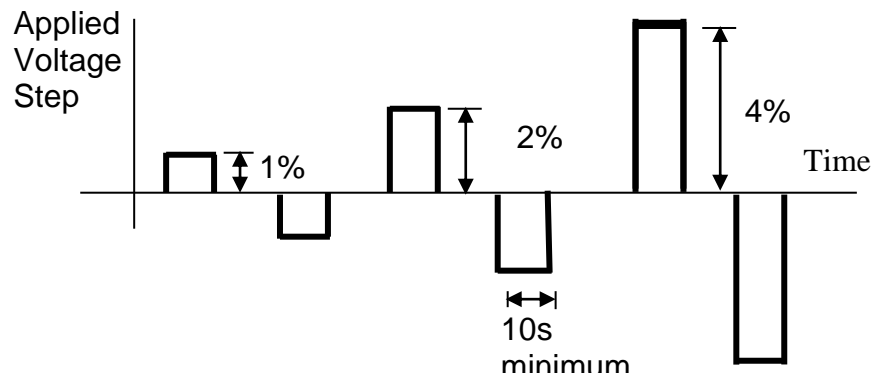

ECP.A.7.4 Figure 2 – Step injection sequence for voltage control tests

ECP.A.7.5 Frequency Response Tests

ECP.A.7.5.1 This section describes the procedure for performing frequency response testing on **HVDC Equipment**. These tests should be scheduled at a time where there is sufficient MW resource in order to import and export full **Maximum Capacity** of the **HVDC Equipment**. The **HVDC System Owner** is responsible for ensuring that suitable arrangements are in place with the **Externally Interconnected System Operator** to facilitate the **Active Power** changes required by these tests

ECP.A.7.5.2 The frequency controller shall be in **Frequency Sensitive Mode** or **Limited Frequency Sensitive Mode** as appropriate for each test. Simulated frequency deviation signals shall be injected into the frequency controller Setpoint/feedback summing junction. If the injected frequency signal replaces rather than sums with the real **System Frequency** signal, then the additional tests outlined in ECP.A.7.5.6 shall be performed with the **HVDC Equipment** in normal **Frequency Sensitive Mode** monitoring actual **System Frequency**, over a period of at least 10 minutes. The aim of this additional test is to verify that the control system correctly measures the real **System Frequency** for normal variations over a period of time.

ECP.A.7.5.3 In addition to the frequency response requirements, it is necessary to demonstrate the **HVDC Equipment** ability to deliver a requested steady state power output which is not impacted by power source variation as per ECC.6.3.9. This test shall be conducted in **Limited Frequency Sensitive Mode** at a part-loaded output for a period of 10 minutes as per ECP.A.7.5.6.

Preliminary Frequency Response Testing

ECP.A.7.5.4 Prior to conducting the full set of tests as per ECP.A.7.5.6, **HVDC System Owners** are required to conduct a preliminary set of tests below to confirm the frequency injection method is correct and the plant control performance is within expectation. The test numbers refer to Figure 1 below. These tests should be scheduled at a time where there is sufficient MW resource in order to export full **Maximum Capacity** from the **HVDC Equipment**. The following frequency injections shall be applied when operating at module load point 4.

Test No	Frequency Injection	Notes
---------	---------------------	-------

(Figure1)		
8	<ul style="list-style-type: none"> <li>• Inject -0.5Hz frequency fall over 10 sec</li> <li>• Hold for a further 20 sec</li> <li>• At 30 sec from the start of the test, Inject a +0.3Hz frequency rise over 30 sec.</li> <li>• Hold until conditions stabilise</li> <li>• Remove the injected signal as a ramp over 10 seconds</li> </ul>	
13	<ul style="list-style-type: none"> <li>• Inject - 0.5Hz frequency fall over 10 sec</li> <li>• Hold until conditions stabilise</li> <li>• Remove the injected signal as a ramp over 10 seconds</li> </ul>	
14	<ul style="list-style-type: none"> <li>• Inject +0.5Hz frequency rise over 10 sec</li> <li>• Hold until conditions stabilise</li> <li>• Remove the injected signal as a ramp over 10 seconds</li> </ul>	
H	<ul style="list-style-type: none"> <li>• Inject - 0.5Hz frequency fall as a stepchange</li> <li>• Hold until conditions stabilise</li> <li>• Remove the injected signal as a stepchange</li> </ul>	
I	<ul style="list-style-type: none"> <li>• Inject +0.5Hz frequency rise as a stepchange</li> <li>• Hold until conditions stabilise</li> <li>• Remove the injected signal as a stepchange</li> </ul>	

ECP.A.7.5.5 The recorded results (e.g. Finj, MW and control signals) should be sampled at a minimum rate of 1Hz to allow **The Company** to assess the plant performance from the initial transients (seconds) to the final steady state conditions (5-15 minutes depending on the plant design). This is not witnessed by **The Company**. The **HVDC System Owner** shall supply the recordings including data to **The Company** in an electronic spreadsheet format. Results shall be legible, identifiable by labelling, and shall have appropriate scaling.

Full Frequency Response Testing Schedule Witnessed by **The Company**

ECP.A.7.5.6 The tests are to be conducted at a number of different Module Load Points (MLP). In the case of **HVDC Equipment** the load points are conducted as shown below unless agreed otherwise by **The Company**.

Module Load Point 6 (Maximum <b>HVDC Active Power Transmission Capacity</b> )	100% MaxHAPTC
Module Load Point 5	90% MaxHAPTC
Module Load Point 4	80% MaxHAPTC
Module Load Point 3	$\text{MinHAPTC} + 0.6 \times (80\% \text{MaxHAPTC} - \text{MinHAPTC})$
Module Load Point 2	$\text{MinHAPTC} + 0.3 \times (80\% \text{MaxHAPTC} - \text{MinHAPTC})$
Module Load Point 1 ( <b>Minimum HVDC Active Power Transmission Capacity</b> )	MinHAPTC

ECP.A.7.5.7 The tests are divided into the following two types;

- (i) Frequency response compliance and volume tests as per ECP.A.7.5. Figure 1. These tests consist of frequency profile and ramp tests and adjustments to **Target Frequency** setpoint as per ECP.A.7.5 Figure 3.
- (ii) System islanding and step response tests as shown by ECP.A.7.5 Figure 2

ECP.A.7.5. Fig 1 and 2 are shown for the Importing of **Active Power**, simulated frequency polarity should be reversed when exporting **Active Power**.

ECP.A.7.5.8 There should be sufficient time allowed between tests for control systems to reach steady state (depending on available power resource). Where the diagram states 'HOLD' the current injection should be maintained until the **Active Power** (MW) output of the **HVDC Equipment** has stabilised or 90 seconds whichever is the longer. All frequency response tests should be removed over the same timescale for which they were applied. **The Company** may require repeat tests should the response volume be affected by the available power, or if tests give unexpected results. When witnessed by **The Company** each test should be carried out as a separate injection, when not witnessed by **The Company** there must be sufficient time allowed between tests for the **Active Power** (MW) output of the **HVDC Equipment** to have stabilised or 90 seconds, whichever is the longer.

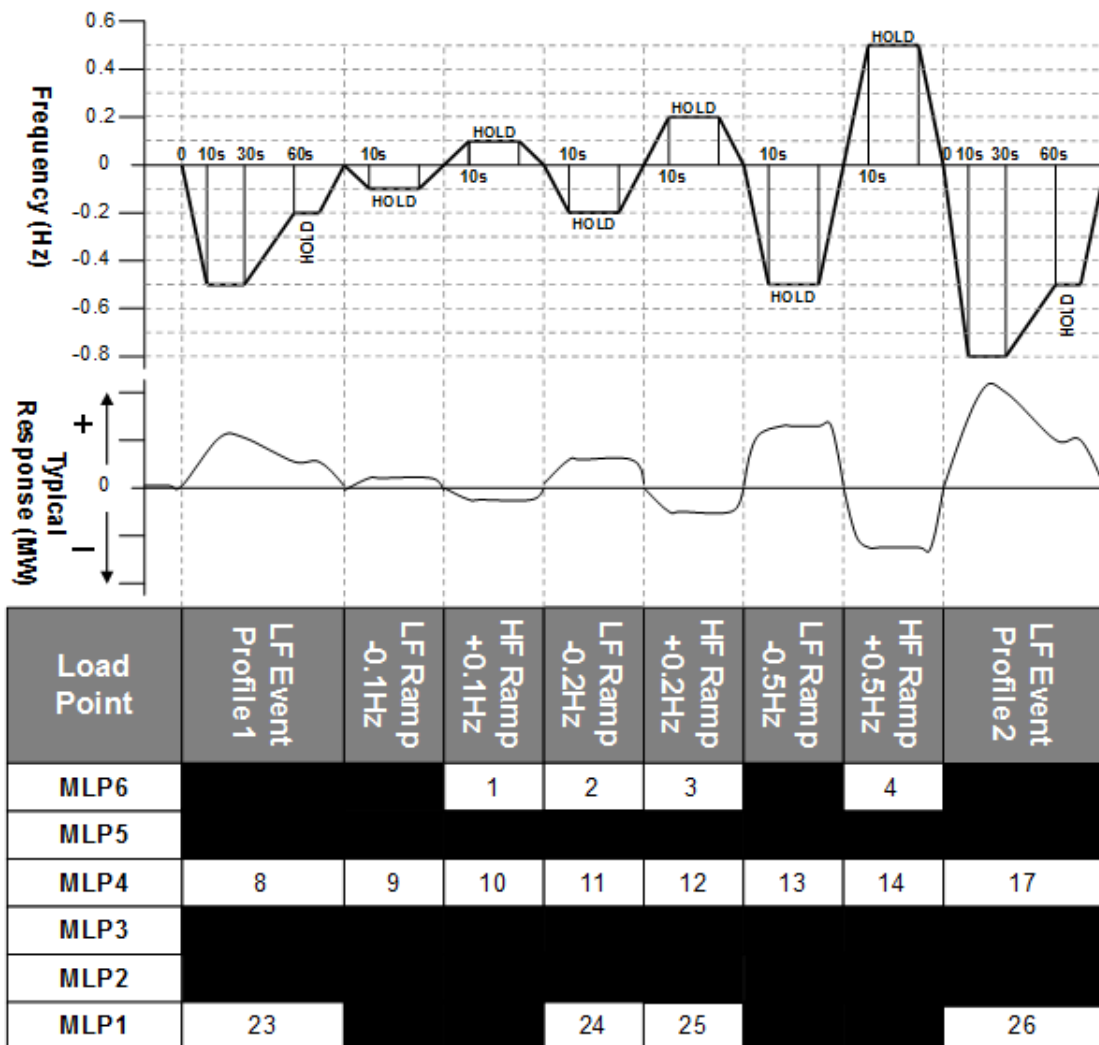

ECP.A.7.5. Figure 1 – Frequency Response Capability FSM Ramp Response tests



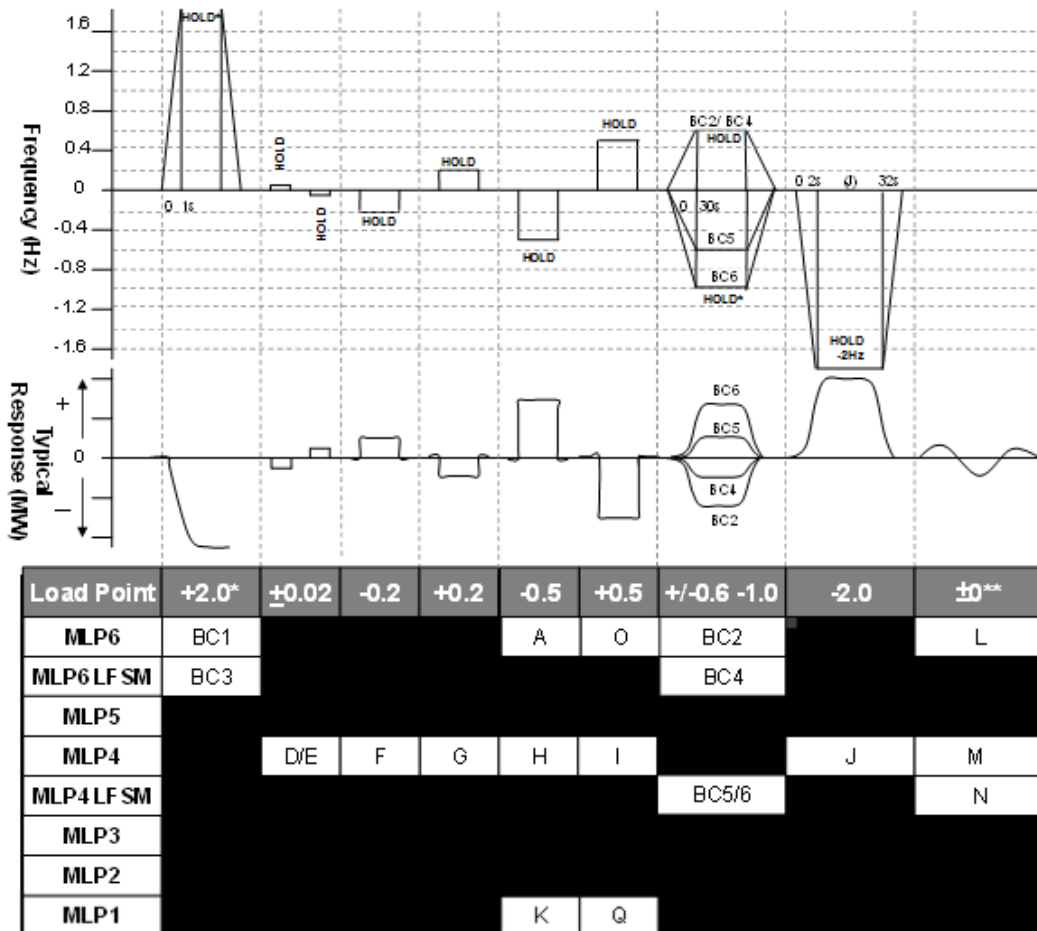

ECP.A.7.5. Figure 2 – Frequency Response Capability LFSM-O, LFSM-U, FSM Step Response tests

\* This will generally be +2.0Hz unless an injection of this size causes a reduction in plant output that takes the operating point below the **Minimum Regulating Level** in which case an appropriate injection should be calculated in accordance with the following:

For example 0.9Hz is needed to take an initial output 65% to a final output of 20%. If the initial output was not 65% and the **Minimum Regulating Level** is not 20%, then the injected step should be adjusted accordingly as shown in the example given below

Initial Output		65%
<b>Minimum Regulating Level</b>	20%	
Frequency Controller Droop		4%
Frequency to be injected =		$(0.65-0.20) \times 0.04 \times 50 = 0.9\text{Hz}$

\*\* Tests L and M in Figure 2 shall be conducted if in this range of tests the **System Frequency** feedback signal is replaced by the injection signal rather than the injection signal being added to the **System Frequency** signal. The tests will consist of monitoring the **HVDC Equipment in Frequency Sensitive Mode** during normal **System Frequency** variations without applying any injection. Test N in Figure 2 shall be conducted in all cases. All three tests should be conducted for a period of at least 10 minutes.

ECP.A.7.5.9 The target frequency adjustment facility should be demonstrated from the normal control point within the range of 49.9Hz to 50.1Hz by step changes to

the **Target Frequency** setpoint as indicated in ECP.A.7.5 Figure 3 while operating at MLP4.

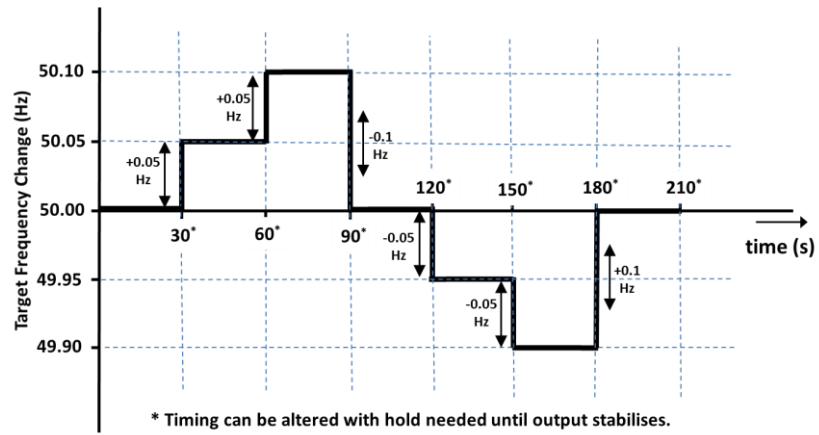

ECP.A.7.5. Figure 3 – Target Frequency setting changes

## APPENDIX 8

### SIMULATION STUDIES AND COMPLIANCE TESTING FOR NETWORK OPERATORS AND NON-EMBEDDED CUSTOMERS PLANT AND APPARATUS

- ECP.A.8.1 Compliance testing for disconnection and reconnection of Network Operator's Plant and Apparatus
- ECP.A.8.1.1 **Network Operators** shall comply with the following applicable requirements in respect of **EU Grid Supply Points**:
- (i) Demand disconnection schemes;
  - (ii) Synchronising; and/or
  - (iii) low frequency demand disconnection;
- ECP.A.8.1.2 The requirements for demand disconnection, other than low frequency demand disconnection, are pursuant to the requirements of the **Bilateral Agreement**. Any requirements for testing shall be agreed with the **User** where such requirements are applicable.
- ECP.A.8.1.3 The requirements for synchronising (where applicable) shall be pursuant to the requirements of the **Bilateral Agreement** and ECC.6.2.3.10. Any requirements for testing (as applicable) shall be agreed with the **User** and carried out during the commissioning process.
- ECP.A.8.1.4 **Network Operators** who are **EU Code Users** must demonstrate compliance with the low frequency demand disconnection requirements of ECC.6.4.3, ECC.A.5 and OC.6.6 for their entire distribution **System**.
- ECP.A.8.1.5 An equipment certificate may be submitted to **The Company** instead of part of the tests provided for in ECP.A.8.1.1.
- ECP.A.8.2 Compliance testing for operational metering at EU Grid Supply Points
- ECP.A.8.2.1 The requirements for operational metering (where required) shall be pursuant to the requirements of the **Bilateral Agreement** and ECC.6.5.6. Any applicable requirements for testing shall be agreed with the **User** and carried out during the commissioning process. An **Equipment Certificate** may be used for this purpose where agreed with **The Company**.
- ECP.A.8.3 Compliance testing for disconnection and reconnection of Non-Embedded Customers Plant and Apparatus
- ECP.A.8.3.1 **Non-Embedded Customers** shall comply with the following requirements where applicable:
- (i) Demand disconnection schemes;
  - (ii) Synchronising; and/or
  - (iii) low frequency demand disconnection;
- ECP.A.8.3.2 The requirements for demand disconnection, other than low frequency demand disconnection, are pursuant to the requirements of the **Bilateral Agreement**. Any requirements for testing shall be agreed with the **User**.
- ECP.A.8.3.3 The requirements for synchronising (where applicable) shall be pursuant to the requirements of the **Bilateral Agreement** and ECC.6.2.3.10. Any requirements for testing (as applicable) shall be agreed with the **User** and carried out during the commissioning process.

ECP.A.8.3.4 **Non-Embedded Customers** who are **EU Code Users** must demonstrate compliance with the low frequency demand disconnection requirements of ECC.6.4.3, ECC.A.5 and OC.6.6 of their **System**.

ECP.A.8.3.5 An equipment certificate may be submitted to **The Company** instead of part of the tests provided for in ECP.A.8.3.1.

ECP.A.8.4 Compliance testing for operational metering on Non-Embedded Customers Plant and Apparatus

ECP.A.8.4.1 The requirements for operational metering (where required)) shall be pursuant to the requirements of the **Bilateral Agreement** and ECC.6.5.6. Any applicable requirements for testing shall be agreed with the **User** and carried out during the commissioning process. An **Equipment Certificate** may be used for this purpose where agreed with **The Company**. ECP.A.8.5 Common Provisions on Compliance Simulations

ECP.A.8.5.1 **Users** are required to provide simulation studies or equivalent information to the satisfaction of **The Company** in the following circumstances.

- (i) a new connection to the **Transmission System** is required forming part of an **EU Grid Supply Point**;
- (ii) a **Substantial Modification** takes place at an **EU Grid Supply Point**
- (iii) **The Company** becomes aware of a potential non-compliance by the **Network Operator** or **Non-Embedded Customer** at an **EU Grid Supply Point**.

ECP.A.8.5.2 Notwithstanding the requirements of ECP.A.8.5.1, **The Company** shall be entitled to:-

- (a) Allow the **Network Operator** or **Non-Embedded Customer** to carry out an alternative set of simulations (or equivalent information) provided that they demonstrate that the **Network Operators** or **Non-Embedded Customers Plant and Apparatus** is capable of satisfying the applicable requirements of the **Data Registration Code**.
- (b) Require the **Network Operator** or **Non-Embedded Customer** to carry out additional or alternative simulations (or equivalent information) to those specified in ECP.A.8.5.1 where they would otherwise be insufficient to demonstrate compliance.
- (c) **The Company** may check that the **Network Operator** or **Non-Embedded Customer** complies with the requirements of the **Grid Code** by carrying out its own compliance simulations based on the simulation reports, models and test measurements submitted under the **Data Registration Code**.

ECP.A.8.5.3 **The Company** will supply (under PC.A.8) upon request to the **Network Operator** or **Non-Embedded Customer**, data to enable the **Network Operator** or **Non-Embedded Customer** to carry out the required simulations or supply the equivalent information required under the **Data Registration Code**.

ECP.A.8.6 Compliance simulations for EU Grid Supply Points

ECP.A.8.6.1 **Networks Operators** who are also **EU Code Users**, are required to provide simulation studies (or make available equivalent information) at each **EU Grid Supply Point** to demonstrate compliance with the **Reactive Power** capability requirements set out in ECC.6.4.5. The study or equivalent information provided shall include a steady state simulation model under both maximum



and minimum demand conditions. In addition, the model or equivalent information provided shall include the conditions when the **Reactive Power** export is at an **Active Power** flow of less than 25% of the **Maximum Import Capability** as detailed under ECC.6.4.5.2. In all cases the models or equivalent information submitted shall be agreed and approved with **The Company**.

ECP.A.8.7 Compliance simulations for Non-Embedded Customers Plant and Apparatus

ECP.A.8.7.1 **None Embedded Customers** who are also **EU Code Users** are required at each **EU Grid Supply Point** to provide simulation studies (or equivalent information) to demonstrate compliance with the **Reactive Power** capability requirements set out in ECC.6.4.5. The study or equivalent information provided shall include a steady state simulation model under both maximum and minimum demand conditions and with and without on-site generation. In all cases the models or equivalent information submitted shall be agreed and approved with **The Company**.

ECP.A.8.8 Compliance monitoring at EU Grid Supply Points

ECP.A.8.8.1 To satisfy the requirements of ECC.6.4.5, **EU Code Users** who are either **Network Operators** or **Non-Embedded Customers** shall ensure their **Plant** and **Apparatus** is equipped (where applicable), with the necessary equipment to measure the **Active Power** and **Reactive Power**, at each **EU Grid Supply Point**. The requirement for and time frame for compliance monitoring shall be agreed between **The Company** and the **EU Code User** for each **EU Grid Supply Point**.

APPENDIX 9  
COMPLIANCE TESTING FOR GRID FORMING PLANT

ECP.A.9.1 SCOPE

ECP.A.9.1.1 This Appendix outlines the general testing requirements for **Users** or **Non-CUSC Parties** to demonstrate compliance with the relevant aspects of the **Grid Code, Ancillary Services Agreement** and **Bilateral Agreement**. The tests specified in this Appendix will normally be sufficient to demonstrate compliance of a **GBGF-I**, however **The Company** may:

- i) agree to an alternative set of tests provided **The Company** deem the alternative set of tests sufficient to demonstrate compliance with the **Grid Code, Ancillary Services Agreement** and **Bilateral Agreement**; and/or
- ii) require additional or alternative tests if information supplied to **The Company** during the compliance process suggests that the tests in this Appendix will not fully demonstrate compliance with the relevant section of the **Grid Code, Ancillary Services Agreement** or **Bilateral Agreement**; and/or
- iii) require additional tests if control functions to improve damping of power system oscillations or additional functions to prove the capability of the **GBGF-I** is required by the **Bilateral Agreement** or included in the control scheme; and/or
- iv) agree a reduced set of tests for the subsequent **GBGF-I** following successful completion of the first **Grid Forming** tests in the case of an installation comprising of two or more **GBGF-Is** which **The Company** reasonably considers to be identical if: -
  - (a) the tests performed pursuant to ECP.A.9.1.9 in respect of subsequent **GBGF-I Plants** do not replicate the full tests for the first **GBGF-I**; or
  - (b) any of the tests performed pursuant to ECP.A.9.1.9 do not fully demonstrate compliance with the relevant aspects of the **Grid Code, Ancillary Services Agreement** and / or **Bilateral Agreement**.

ECP.A.9.1.2 The **User or Non-CUSC Party** is responsible for carrying out the tests set out in and in accordance with this Appendix and the **User or Non-CUSC Party** retains the responsibility for the safety of personnel and plant during the test. **The Company** will witness all of the tests outlined or agreed in relation to this Appendix unless **The Company** decides and notifies the **User or Non-CUSC Party** otherwise. For all on site at **The Company** witnessed tests, the **User or Non-CUSC Party** must ensure suitable representatives from the **Grid Forming Plant's** manufacturer (if appropriate) are available on site for the entire testing period. In all cases and in addition to any recording of signals conducted by **The Company**, the **User or Non-CUSC Party** shall record all relevant test signals as outlined in ECP.A.4.

ECP.A.9.1.3 In addition to the dynamic signals supplied in ECP.A.4, the **User or Non-CUSC Party** shall inform **The Company** of the following information prior to the commencement of the tests and any changes to the following, if any values change during the tests:

- (i) All relevant transformer tap numbers, if used.
- (ii) Number of **Grid Forming Units** in operation.

ECP.A.9.1.4 The **User or Non-CUSC Party** shall submit a detailed schedule of tests to **The Company** in accordance with ECP.6.3.1, and this Appendix.

ECP.A.9.1.5 Prior to the testing of the **GBGF-I** the **User or Non-CUSC Party** shall complete

the **Integral Equipment Tests** procedure in accordance with OC.7.5.

- ECP.A.9.1.6 Full **GBGF-I** testing as required by ECP.7.2 is to be completed as defined in ECP.A.9.1.9.
- ECP.A.9.1.7 **The Company** will permit relaxation from the requirements in ECP.A.9.1.9 where an **Equipment Certificate** for **GBGF-I** has been provided which details the characteristics from tests on a representative installation with the same equipment and settings and the performance of the **GBGF-I** can, in **The Company's** opinion, reasonably represent that of the installed **GBGF-I** at that site. The relevant **Equipment Certificate** must be supplied in the **Users Data File Structure**.
- ECP.A.9.1.8 Prior to any **GBGF-I** tests taking place, the **User** or **Non-CUSC Party** shall have completed the relevant compliance tests on the **GBGF-I**, **Power Generating Module** or **Generating Unit** as required under ECP.A.5 or OC5. A.2 (as relevant) or **Power Park Module** as required under ECP.A.6 or OC5. A.3 (as applicable) or **HVDC Systems** or **DC Converters** as required under ECP.A.7 or OC5. A.4 (as applicable).
- ECP.A.9.1.9 Demonstration of **Grid Forming Capability**
- ECP.A.9.1.9.1 This section details the procedure for demonstrating **Active ROCOF Response Power**. Ideally if the test is being completed as part of a type test on an isolated network and it is possible to change the frequency of the isolated network then the tests should be completed using a variable network **Frequency**. **The Company** recognise that it is not possible in a large number of cases to adjust the network frequency of the network to which the **Grid Forming Plant** is connected. If a suitable test network is not available, performance of the **GBGF-I** will need to be demonstrated through online monitoring as detailed in CC.6.6 or ECC.6.6 and simulation studies as required under ECP.A.3.9.4 will be required during the **Interim Operational Notification Process** as provided for under CP.6 or ECP.6 (as applicable).
- ECP.A.9.1.9.2 In this test, with the **Grid Forming Plant** initially running at full load, the test network frequency is ideally increased from 50Hz to 51 Hz at a rate of 1Hz/s with measurements of the **Grid Forming Plant's Active ROCOF Response Power, System Frequency** and time in (ms). The test is required to assess correct operation of the **Grid Forming Plant** without saturating. This test is then repeated for a 50 Hz to 49 Hz at a rate of 1Hz/s.
- ECP.A.9.1.9.3 These tests are required to assess the **Grid Forming Plant's** withstand capabilities under extreme **System Frequencies**.
- (i) For **Grid Forming Plant** comprising a **GBGF-I** the frequency of the test network is increased from 50Hz to 52Hz at a rate of 2Hz/s with measurements of the **Grid Forming Plant's Active ROCOF Response Power, System Frequency** and time in (ms).
  - (ii) For a **Grid Forming Plant** comprising a **GBGF-I** the frequency of the test network is increased from 50Hz to 52Hz at a rate of 1Hz/s with measurements of the **Grid Forming Plant's Active ROCOF Response Power, System Frequency** and time in (ms).
  - (iii) For **Grid Forming Plant** comprising a **GBGF-I** the frequency of the test network is decreased from 50Hz to 47 Hz at a rate of 2Hz/s with measurements of the **Grid Forming Plant's Active ROCOF Response Power, System Frequency** and time in (ms).

- (iii) For **Grid Forming Plant** comprising a **GBGF-I** the frequency of the test network is decreased from 50Hz to 47 Hz at a rate of 1Hz/s with measurements of the **Grid Forming Plant's Active ROCOF Response Power, System Frequency** and time in (ms).

ECP.A.9.1.9.4 This test is to demonstrate the **Grid Forming Plant's** ability to supply **Active ROCOF Response Power** over the full **System Frequency** range.

- (a) With the frequency of the test network set to 50Hz, the **GBGF-I** should be initially running at 75% **Maximum Capacity** or **Registered Capacity**, zero MVA<sub>r</sub> output and both **Limited Frequency Sensitive Mode** and **Frequency Sensitive Mode** disabled.
- (b) The frequency is then increased from 50Hz to 52Hz at a rate of 1Hz/s over a 2 second period. Allow conditions to stabilise for 5 seconds and then decrease the frequency from 52Hz to 47Hz at a rate of 1Hz/s over a 5 second period. Allow conditions to stabilise.
- (c) Record results of **Active ROCOF Response Power, Reactive Power**, voltage and frequency.
- (d) The test now needs to be re-run in the opposite direction. The same initial conditions should be applied as per ECP.A.9.1.9.4(a).
- (e) The frequency is then decreased from 50Hz to 47Hz at a rate of 1Hz/s over a 3 second period. Allow conditions to stabilise for 5 seconds and then increase the frequency from 47Hz to 52Hz at a rate of 1Hz/s over a 5 second period. Allow conditions to stabilise.
- (f) Record results of **Active ROCOF Response Power, Reactive Power**, voltage and frequency.

ECP.A.9.1.9.5 This test is to demonstrate the **Grid Forming Plant's** ability to supply **Active Phase Jump Power** under normal operation.

- (a) With the frequency of the test network set to 50Hz, the **GBGF-I** should be initially running at **Maximum Capacity** or **Registered Capacity** or at its agreed deloaded point, zero MVA<sub>r</sub> output and all control actions (e.g. **Limited Frequency Sensitive Mode, Frequency Sensitive Mode** and voltage control) disabled.
- (b) Apply a positive phase jump of up to the **Phase Jump Angle Limit** at the **Grid Entry Point** or **User System Entry Point** (if **Embedded**).
- (c) This test can then be repeated by injecting the same angle into the **Grid Forming Plant's** control system (as indicatively shown in Figure ECP.A.9.1.9.5). This specific test can be repeated on site as required for a routine performance evaluation test. It should be noted that Figure ECP.A.9.1.9.5 is a simplified representation. Each **Grid Forming Plant Owner** can use their own design, that may be very different to Figure ECP.A.9.1.9.5 but should contain all relevant functions that can include test points and other equivalent data and documentation. Any additional signals, measurements, parameters and tests shall be agreed between the **Grid Forming Plant Owner** and **The Company**.
- (d) Repeat tests (b) and (c) with a negative injection up to the **Phase Jump Angle Limit**.
- (e) Record traces of **Active Power, Reactive Power**, voltage, current and frequency for a period of 10 seconds after the step change in phase has been applied.



**Frequency Sensitive Mode, Frequency Sensitive Mode** and voltage control) disabled.

- (b) Apply a solid three phase short circuit fault at the connection point in the test network forming part of the type test for 140ms or alternatively the equivalent of a zero retained voltage for 140ms.
- (c) Record traces of **Active Power, Reactive Power**, voltage, current and frequency for a period of 10 seconds after the fault has been applied.
- (d) Repeat steps (a) to (c) but on this occasion with fault ride through, **GBGF Fast Fault Current Injection Limited Frequency Sensitive Mode** and voltage control switched into service.
- (e) Record traces of **Active Power, Reactive Power**, voltage, current and frequency for a period of 10 seconds after the step change in phase has been applied and confirm correct operation.

ECP.A.9.1.9.8 The final test required is to demonstrate the **GBGF-I** is capable of contributing to **Active Damping Power**. The **Grid Forming Plant Owner** should configure their **Grid Forming Plant** in form or equivalent (as agreed with **The Company**) as shown in Figure ECP.A.3.9.6(a) or Figure ECP.A.3.9.6(b) as applicable. Each **Grid Forming Plant Owner** can use their own design, that may be very different to Figures ECP.A.3.9.6(a) or ECP.A.3.9.6 (b) but should contain all relevant functions.

As part of this test, the **Grid Forming Plant Owner** is required to inject a signal into the **Grid Forming Plant** controller. The results supplied need to verify the following criteria:-

- i) Inject a **Test Signal** into the **Grid Forming Plant** controller to demonstrate the **Active Control Based Power** output is supplied below the 5Hz bandwidth limit. An acceptable performance will be judged where the overshoot or decay matches the **Damping Factor** declared by the **Grid Forming Plant Owner** as submitted in PC.A.5.8.1 in addition to assessment against the requirements of CC.A.6.2.6.1 or ECC.A.6.2.6.1 or CC.A.7.2.2.5 or ECC.A.7.2.5.2 as applicable.

<END OF ECP>