

Stage 04: Code Administrator Consultation

Grid Code

GC0104: EU Connection Codes GB Implementation – Demand Connection Code

Purpose of Modification:





This modification will set out within the Grid and Distribution Codes the following compliance obligations in the European Network Code – Demand Connection Code (DCC):

1. Technical requirements for new* Transmission-connected Demand Facilities; Transmission-connected Distribution Facilities and Distribution Systems.
2. Technical requirements for Demand Units used by a Demand Facility or a Closed Distribution System to provide Demand Response Services to System Operators.

* 'New' is defined as not being connected to the system at the time that the code enters into force and not having concluded a final and binding contract for the purchase of main plant items by two years after entry into force.

What stage is this document at?

01	Proposal form
02	Workgroup Consultation
03	Workgroup Report
04	Code Administrator Consultation
05	Draft Final Modification Report
06	Report to the Authority

	The purpose of this document is to consult on GC0104 with Grid Code parties and other interested industry members. Parties are requested to respond by 5pm on 08 June 2018 to grid.code@nationalgrid.com using the Code Administrator Consultation Response Pro-forma which can be found via the following link:
Published on:	17 May 2018
Length of Consultation:	15 Working days
Responses by:	08 June 2018
	High Impact: <i>Transmission System Operators (TSOs), Transmission Connected Demand Facilities, Demand Facilities providing DSR, Aggregators and Directly Connected Transmission Facilities; Distribution Network Operators</i>
	Medium Impact: <i>Operators of Demand schemes considering modernisation.</i>
	Low Impact: <i>None identified</i>
	The Workgroup concludes: The Workgroup, by majority, concluded that WACM1 best facilitates the Grid Code Objectives



Any Questions?

Contact:

Chrissie Brown

Code Administrator



[christine.brown1](mailto:christine.brown1@nationalgrid.com)

[@nationalgrid.com](https://twitter.com/nationalgrid)



01926 65 3328

Proposer:

Rachel Woodbridge-

Stocks – NGET SO

1	Summary	5
2	Original Proposal	7
3	Governance	8
4	Why Change?	8
5	Code Specific Matters	9
6	Solution	10
7	Updated solution following workgroup consultation.....	23
8	Impacts and Other Considerations.....	25
9	Workgroup Discussions – Initial four Workgroup meetings	25
10	Summary of Workgroup Consultation responses	33
11	Workgroup Discussions following Workgroup Consultation	33
12	Workgroup Vote	36
13	Relevant Objectives - assessment by Proposer	39
14	Implementation	40
15	Code Administrator Consultation: How to respond.....	40
	Annex 1 Demand Response table	41
	Annex 2 Draft legal text comments from Workgroup Consultation	43
	Annex 3 Terms of Reference	43
	Annex 4 DCC Code Mapping	48
	Annex 5 Workgroup Consultation responses	48
	Annex 6 Summary presentation – Workgroup Consultation responses	118
	Annex 7 WACM1 Alternative form – Official alternative	129
	Annex 8 Grid Code Legal Text.....	136

Timetable

The following timetable has been set by the Grid Code Panel:	
Workgroup Meeting 1	06 September 2017
Workgroup Meeting 2	06 December 2017
Workgroup Meeting 3	23 January 2018
Workgroup Meeting 4	7 February 2018
Workgroup Consultation open/closes	8 March 2018/29 March 2018
Workgroup Meeting 5	4 April 2018
Workgroup meeting 6	23 April 2018
Workgroup Report issued to the Grid Code Panel	8 May 2018
Workgroup Report presented to Panel	16 May 2018
Code Administration Consultation Report issued to the Industry/Code Administrator Consultation closes	17 May 2018/8 June 2018
Draft Final Modification Report presented to Panel	8 June 2018
Grid Code Panel Recommendation Vote	14 June 2018
Final Modification Report issued the Authority	25 June 2018
Authority Decision	31 July 2018
Decision implemented in Grid Code	7 September 2018

About this document

This document is the Code Administrators Consultation document that contains the discussion of the Workgroup which formed in August 2017 to develop and assess the proposal, the responses to the Workgroup Consultation which closed on 29 March 2018, the voting of the Workgroup held on 04 April 2018. The Panel reviewed the Workgroup Report at their Grid Cods Panel meeting on 16 May 2018 and agreed that the Workgroup had met its Terms of Reference and that the Workgroup could be discharged.

GC0104 was proposed by National Grid and was submitted to the Grid Code Modifications Panel for its consideration on 16 August 2017. The Panel decided to send the Proposal to a Workgroup to be developed and assessed against the Grid Code Objectives.

GC0104 aims to set out within the Grid and Distribution Codes the following compliance obligations in the European Network Code – Demand Connection Code (DCC):

1. Technical requirements for new* Transmission-connected Demand Facilities; Transmission-connected Distribution Facilities and Distribution Systems.

2. Technical requirements for Demand Units used by a Demand Facility or a Closed Distribution System to provide Demand Response Services to System Operators.

The Workgroup consulted on this Modification and a total of 11 responses were received. These responses can be located in Annex 5 of this Report.

Workgroup Conclusions

At the final Workgroup meeting, Workgroup members voted on the Original proposal and WACM1. The Workgroup, by majority, voted that WACM1 better facilitated the Grid Code objectives.

<https://www.nationalgrid.com/uk/electricity/codes/grid-code/modifications/gc0104-eu-connection-codes-gb-implementation-demand>

The table below details these specific areas and where the Workgroup have covered them or will cover post Workgroup Consultation.

The full Terms of Reference can be found in Annex 3.

Table 1: GC0104

Specific Area	Location in the report
a) <i>Implementation;</i>	Section 14
b) <i>Review draft legal text should it have been provided. If legal text is not submitted within the Grid Code Modification Proposal the Workgroup should be instructed to assist in the developing of the legal text; and</i>	Annex 8
c) <i>Consider whether any further Industry experts or stakeholders should be invited to participate within the Workgroup to ensure that all potentially affected stakeholders have the opportunity to be represented in the Workgroup.</i>	Attendance of Proposer at wider Industry meetings, webex carried out and wider attendance of those impacted following initial meetings eg Flextricity
d) <i>Technical requirements for new* Transmission-connected Demand Facilities; Transmission-connected Distribution Facilities and Distribution Systems.</i>	Outlined in Sections 6 and 7 and discussed in 8
e) <i>Technical requirements for Demand Units used by a Demand Facility or a Closed Distribution System to provide Demand Response Services to System Operators. 'New' is defined as not being connected to the system at the time that the code enters into force and not having</i>	Outlined in Sections 6 and 7 and discussed in 8

<i>concluded a final and binding contract for the purchase of main plant items by two years after entry into force.</i>	
<i>f) The scope and applicability of the EU requirements under DCC, specifically articles are 12-47</i>	Outlined in Sections 6 and 7 and discussed in 8
<i>g) DSR impact</i>	Outlined in Sections 6 and 7 and discussed in 8

Acronyms table

Acronym used	Full meaning
DCC	Demand Connection Code
SCTs	Standard Contract Terms
DRSC	Demand Response Services Code
GSP	Grid Supply Point

Document Control

Version	Date	Author	Change Reference
0.1	02 February 2018	Code Administrator	Draft Workgroup Consultation to Workgroup
0.2	06 March 2018	Workgroup	Draft Workgroup Consultation to Workgroup
0.3	08 March 2018	Workgroup	Workgroup Consultation to Industry
0.4	01 May 2018	Workgroup	Draft Workgroup Report for issue to Grid Code Panel
0.5	09 May 2018	Workgroup	Workgroup Report to Grid Code Panel
0.6	17 May 2018	Code Administrator	Code Administrator Consultation to Industry

1 Summary

- 1.1 GC0104 was proposed by National Grid and was submitted to the Grid Code Review Panel for their consideration on 16 August 2017 and the Distribution Code Review Panel 7 September 2017.
- 1.2 The Grid Code Review Panel decided to send the Proposal to a Workgroup to be developed and assessed against the Grid Code Applicable Objectives.
- 1.3 Section 2 (Original Proposal), Section 6 (Proposer's solution) and Section 7 (Solution following Workgroup Consultation) are sourced directly from the Proposer and any statements or assertions have not been altered or substantiated/supported or refuted by the Workgroup. Section 8 and 11 of the Workgroup Report contains the discussion by the Workgroup on the Proposal and the proposed solution.
- 1.4 The Grid Code and Distribution Code Review Panels detailed in the Terms of Reference the scope of work for the GC0104 Workgroup and the specific areas that the Workgroup should consider. This can be found in Annex 3.
- 1.5 Please note that the proposed legal text that can be found in Annex 8 has been sourced from Grid Code Modifications GC0100, 101 and 102 (the Original proposals and not the alternatives proposed) that propose to amend the Grid Code to comply with the EU Codes RfG (Requirement for Generators) and HVDC (High Voltage Direct Current Connections) and the proposed GC0104 amendments have been drafted on top of this. This has now been approved by the Authority (modifications GC0100, 101 and 102) and is the current baseline in the Grid Code as at the date of the publication of this Consultation document.
- 1.6 The requirements outlined in the legal text for this GC0104 document have been created in the European Compliance Processes and European Connection Conditions that were created for Modification GC0102 (EU Connection Codes GB Implementation – Mod 3). You will also note that the proposed legal text for GC0104 also has an additional new section called DRSC so customers that are not Users and bound by the Grid Code only have to look at this one section.
- 1.7 GC0104 is made up of two elements, the Transmission-Connected Demand and the compliance for it and Demand Response Requirements and compliance for it.

2 Original Proposal

Section 2 (Original Proposal) is sourced directly from the Proposer and any statements or assertions have not been altered or substantiated/supported or refuted by the Workgroup. Section 8 of the Workgroup Consultation contains the discussion by the Workgroup on the Proposal and the potential Solution.

What

Full sections of the Grid and Distribution Codes, for example the Grid Code Connection Conditions (CCs), Planning Code (PC) and the Distribution Code (Distribution Planning and Connection Code (DPC)) will need to be extended to set out the new EU standards to which impacted users will need to comply with. In addition, it is proposed to add a new section to the Grid Code to cater for Demand Response Services which will be called the Demand Response Services Code (DRSC), and a new section, DPC9, to the Distribution Code solely for demand response.

This will result in a combination of completely new requirements inserted into the Grid Code and Distribution Code, and adjustments/continuation of corresponding existing GB requirements to line up with equivalents in the new EU codes.

Why

Guidance from BEIS and Ofgem¹ was to apply the new EU requirements within the existing GB regulatory frameworks. This would provide accessibility and familiarity to GB parties, as well as putting in place a robust governance route to apply the new requirements in a transparent and proportionate way.

This modification needs to be undertaken in a timely manner to ensure impacted users are aware of their compliance obligations - particularly in relation to procurement of equipment, testing and operational requirements. This modification is also therefore, critical to facilitate/demonstrate Member State compliance to this EU Network Code.

How

With the support of the industry, we will use this modification to finalise proposals to apply the EU Connection Codes requirements in DCC, before consulting with the wider industry and submitting to Ofgem for a decision.

Previously, a Joint Grid and Distribution Code Review Panel issue group was formed (GC0091) to:

1. Comprehensively review the code to form a local interpretation of the DCC requirements;
2. Undertake a mapping exercise between the EU and GB codes to understand the extent for possible code changes;
3. Form proposals, which will now be taken forward as formal modifications.

1

¹ <https://www.ofgem.gov.uk/ofgem-publications/92240/openletteronencimplementationandconsultationonnemodesignation-pdf>
Ofgem's 2014 guidance letter on ENC implementation

3 Governance

Given the complexity and wide-ranging impact of the changes proposed in this modification, the Proposer believed that self-governance or fast track governance arrangements was not appropriate for GC0104.

The Grid and Distribution Code Review Panels agreed that this modification would have a material affect and as a result the modification will be submitted to the Authority for decision.

4 Why Change?

This proposal is one of a number of proposals which seek to implement relevant provisions of a number of new EU Network Codes/Guidelines which have been introduced in order to enable progress towards a competitive and efficient internal market in electricity.

The full set of EU network guidelines are;

- Regulation 2015/1222 – Capacity Allocation and Congestion Management (CACM) which entered into force 14 August 2015
- Regulation 2016/1719 – Forward Capacity Allocation (FCA) which entered into force 17 October 2016
- *Regulation 2016/631 - Requirements for Generators (RfG) which entered into force 17 May 2016*
- **Regulation 2016/1388 - Demand Connection Code (DCC) which entered into force 7 September 2016**
- *Regulation 2016/1447 - High Voltage Direct Current (HVDC) which entered into force 28 September 2016*
- Transmission System Operation Guideline (SOGL) which entered into force 14 September 2017
- Emergency and Restoration (E&R) Guideline – entered into force 18 December 2017
- European Balancing Guideline (EBGL) – entered into force 18 December 2017

The DCC was drafted with the objective to improve security of supply; and enhance competition to reduce costs for end consumers, across EU Member States.

The DCC specifically sets harmonised technical standards for the connection of new transmission-connected demand facilities, new transmission-connected distribution facilities and new distribution systems, including new closed distribution systems. It also addresses the performance requirements for new demand units used by a demand facility or a closed distribution system to provide Demand Response to relevant system operators or relevant TSOs. Demand Response is an important instrument for increasing the flexibility of the internal energy market and for enabling optimal use of networks. Historically, generation facilities have formed the backbone of providing technical capabilities to System Operators. However, Demand Facilities are expected to play a more pivotal role in the future.

Significant work to progress GB understanding of the DCC has been undertaken in Grid Code and Distribution Code Review Panel issue group GC0091 and allowed GB stakeholders to engage with the European Code drafting process as led by ENTSO-E. The GC0091 Workgroup was replaced by the GC0104 modification proposal.

GC0091 was widely attended by a range of parties and additional stakeholder engagement has been undertaken to ensure the impacts of DCC is understood, as well as to provide an opportunity to feed into the implementation approach.

Through proposing these modifications under Grid Code Open Governance (rather than continue with GC0091 which was raised under previous Grid Code governance arrangements), the aim is to finalise the proposals in a timely manner; and undertake the necessary consultations to confirm the proposals are appropriate, before submitting the final modification report to Ofgem for a decision.

5 Code Specific Matters

The Technical skillsets that have been outlined below were provided by the Proposer when the modification was originally raised.

The Proposer, Workgroup and Panel have concluded that they have a cross set of members that represent the skillset required as per the below.

Technical Skillsets

- Understanding of the GB regulatory frameworks (particularly Grid Code and Distribution Code)
- High level understanding of the EU codes and their potential impact
- Operational/technical understanding of equipment/facilities /systems which is bound by DCC
- Where appropriate, knowledge of the obligations and operational processes of GB Network Operators and the GB National Electricity Transmission System Operator

Reference Documents

Demand Connection Code legal text:

<http://eur-lex.europa.eu/legal-content/EN/TXT/PDF/?uri=CELEX:32016R1388&from=EN>

Section 5 (Solution) is sourced directly from the Proposer and any statements or assertions have not been altered or substantiated/supported or refuted by the Workgroup. Section 8 of the Workgroup Consultation contains the discussion by the Workgroup on the Proposal and the potential Solution

The solution will ensure that the Grid and Distribution Codes reflect the technical requirements set out in DCC for GB compliance of code users with EU legislation. NGET is proposing to retain the existing Grid Code text as applicable to Demand Users, unless there is a conflict with the DCC requirements, or the DCC requirements require new additions which are not reflected in the current GB Grid Code.

GC0091 identified the specific changes necessary to the Grid and Distribution Codes by undertaking a code mapping exercise. The areas of change are highlighted below:

- Connection requirements affecting new connection of transmission-connected demand facilities, transmission-connected distribution facilities and distribution systems
- Operational notification procedure for new connection of transmission-connected demand facilities, transmission-connected distribution facilities and distribution systems
- Technical requirements of new Demand Units used by a Demand Facility or a Closed Distribution System to provide Demand Response Services to System Operators
- Operational notification procedure for new Demand Units used by a Demand Facility or a Closed Distribution System to provide Demand Response Services to System Operators
- Compliance procedures and requirements: testing, simulations, and monitoring

GC0091 and its subsequent work under GC0104 will address only the technical requirements of DCC.

For the purposes of this consultation the following principles have been adopted:

- i) Retain the same structure and format as the current GB Grid and Distribution Codes.
- ii) Retain the current requirements of the GB Grid and Distribution Codes unless there is good reason not to do so – for example there is either a conflict between the EU Codes and the GB codes or the EU Code requires additions to the GB Codes.
- iii) Ensure that the revised GB Codes are easy to understand and use by those parties affected by them.
- iv) Ensure consistency between the Grid and Distribution Codes and associated industry documents.

Following these principles, NGET is building on the new sections of the Grid Code Connection Conditions called the “European Connection Conditions” (ECC’s) and “European Compliance Processes” (ECP) created via GC0102, as well as existing sections of the Grid Code. This provides a solid foundation upon which to define the EU Connection Codes and implementation of DCC (through GC0104) will easily slot into the format adopted for the RfG and HVDC Codes. These sections apply to EU Code Users who must meet the requirements of the European Codes and ensure consistency between the GB Code and European Code without Users having to refer to two separate documents (i.e. the GB Grid Code and EU Connection Codes). The baseline legal text for GC0104 is established on the Grid Code legal text proposed in the original solution of GC0102 as it was anticipated that a decision would be made for GC0102 before GC0104 reached the Code Administrator Consultation and the Alternative solutions in GC0102 do not materially affect the solution in GC0104.

NGET is also proposing as part of GC0104, the introduction of a new section of the Grid Code, Demand Response Services Code (DRSC), to facilitate the DCC requirements relating to Demand Response Services.

Similarly a new section of the Distribution Code, DPC9, has been drafted as the repository of DSR issues for DCC compliance.

To accompany the legal text and illustrate how the DCC requirements have been discharged in GB, a code mapping table has been produced and is available at the time of this consultation. The sections below provide a high level overview of the proposal and the code mapping table along with the legal text provide the detail.

Articles 1-11 cover the scope of the DCC, including definitions and form part of this modification.

Glossary and Definitions

In general NGET will treat the DCC definitions of Transmission Connected Demand Facility and Transmission Connected Demand User as the GB definition Non-Embedded Customer. The DCC definition Transmission Connected Distribution System will be treated as a Network Operators System which is already an established GB Grid Code definition.

There was some debate around how Grid Supply Points (GSPs) would be treated and defined, particularly existing GSPs that were modified to the extent that they became defined as an EU GSP (i.e. required to comply with DCC) and the effect this would have on corresponding facilities/systems (e.g. a distribution network or a demand facility).

The proposal is to treat a GSP as its own entity, for example if an existing DNO upgrades a GSP to the point it becomes defined as an EU GSP, in DCC terms the GSP would be considered as a Distribution Facility and the requirements that apply to distribution facilities would apply to that single GSP.

In the context of a Distribution Facility (e.g. a demand provider connected to the transmission system), the GSP would be treated as a single entity but in this case would be applicable to the Demand Facility definition of DCC.

These requirements have been incorporated into the Grid Code so the User would not be required to consult the DCC.

Connection requirements affecting the connection of new transmission-connected demand facilities, transmission-connected distribution facilities and distribution systems

This section relates to the following articles:

- General frequency requirements (Article 12)
- General voltage requirements (Article 13)
- Short-circuit requirements (Article 14)
- Reactive power requirements (Article 15)
- Protection requirements (Article 16)
- Control requirements (Article 17)
- Information Exchange (Article 18)
- Demand disconnection and demand reconnection (Article 19)
- Power Quality (Article 20)
- Simulation Models (Article 21)

Article 12 – General Frequency Requirements

Lists the frequency ranges and time periods demand equipment must be capable of remaining connected to the Transmission System. Longer timescales and frequency ranges can be agreed.

The general frequency requirements in DCC are very similar to those currently in the Grid Code and result in no significant change to the current GB text.

Article 13 – General Voltage Requirements

Lists the voltage ranges and time periods demand equipment must be capable of remaining connected to the Transmission System. Longer timescales and voltage ranges can be agreed.

The general voltage requirements in DCC are more or less the same as those currently in the Grid Code though it is pertinent to note that under the current GB Grid Code, voltage ranges of $\pm 10\%$ are permitted at 132kV and $\pm 6\%$ at voltages below 132kV. Under DCC (and also RfG) the range of $\pm 10\%$ applies down to nominal voltage levels of 110kV but this issue is not believed to cause any significant issues in GB due to the lack of equipment in the 110 – 132kV range. For HV equipment below 110kV, the current range of $\pm 6\%$ shall continue to apply as per current GB practice.

Article 14 - Short Circuit Requirements

Article 14 of DCC contains requirements in respect of Short Circuit Requirements at Transmission Connection Points.

During the drafting process, it was agreed and accepted that current GB practice can continue to apply unchanged without causing a conflict with the Short Circuit Requirements in DCC.

Article 15 - Reactive Power Requirements

This defines the requirement for Demand Facilities and Distribution Systems to be capable of maintaining steady-state operation at their connection point within a specified reactive power range and lists a number of conditions to follow.

These requirements are not currently in the Grid Code and as such the legal text from Article 15 will be added into the ECC section of the Grid Code.

It has been noted that as Article 15 doesn't apply to a Distribution Facility, if an Existing DNO was to significantly modify their GSP, the significantly modified GSP would not be required to meet the Reactive Power Requirements set out in Article 15.

Article 16 – Protection Requirements

This article focusses on the protection requirements at the connection point and goes on to list the high level elements necessary. These requirements in DCC are similar to those in the RfG and HVDC Codes which were implemented via GC0102. As such, of the changes introduced to the legal text, they are simply clarifications to the existing GB text with amendments added to ensure consistency with DCC and also to provide clarity on changes to protection settings which traditionally have been included in the Bilateral Connection Agreements.

Article 17 - Control Requirements

This article focusses on the schemes and settings of control devices that are necessary for system security and goes on to list a number of elements that must be covered as a minimum in the agreement with the TSO.

In general these requirements are similar to those in RfG and HVDC. However to ensure consistency with DCC, the GB legal text has been updated to ensure the specific elements in DCC are added to this section and where necessary are referred to in the Bilateral Connection Agreement.

Article 18 - Information Exchange

The TSO must specify the standards required for information exchange between itself and distribution facilities/system owners/operators, who must adhere to these requirements.

In summary the requirements in DCC are very similar to current GB practice. Under the current GB Grid Code the requirements for operational metering are covered under CC.6.5.6 with the exact list of signals being covered under the Bilateral Connection Agreement together with the refresh rates. At the present time National Grid does not publish the standards for information exchange however it is planned to address this by the introduction of a new Electrical Standard which will be referenced in the Annex to the General Conditions. Changes to the RES will occur alongside, but not as part of, this modification.

Article 19 - Demand Disconnection and Reconnection

Low Frequency Demand Disconnection (LFDD)

Low Frequency Demand Disconnection Schemes have been employed in various Grid Systems throughout the world. In general, Transmission Systems are designed to a security standard which defines the level of robustness for a range of credible Transmission System faults for which supplies would not be lost.

LFDD Schemes are designed as a final insurance/defence plan to protect the total system in the event of a sequence of events that go beyond the security criteria. Their aim is to disconnect loads as system frequency falls, normally in defined stages below the minimum frequency criteria defined in the security standard. Whilst demand, will be lost its purpose is to protect the overall integrity of the system without the need for a full black start process to be initiated.

In GB a low frequency demand disconnection scheme has been in operation for many years. LFDD relays are installed at various points across the Total System (i.e. at points on the Transmission System and within the DNO Networks) not just at Grid Supply Points with the first stage of disconnection commencing at 48.8Hz and then subsequent stages operating at lower frequencies until 47Hz when all the LFDD relays will have operated. In GB, by the time the frequency has dropped to 47Hz all the LFDD relays will have operated to the point where 60% of total demand will have tripped.

The requirements for low frequency demand disconnection in GB are very similar to those in DCC and therefore very few changes are required to this section of the Grid Code other than in respect of the need to add the direction of Active Power flow. This amendment has been made to the draft legal text.

Low Voltage Demand Disconnection (LVDD)

Similar to Low Frequency Demand Disconnection, Low Voltage Demand Disconnection achieves reductions in demand through demand disconnections where the voltage drops below a pre-defined threshold. Additional measures can be put in place such as blocking the operation of tap changers on transformers.

In GB there is no LVDD scheme although it was investigated as an option in 2001. Under DCC, low voltage demand disconnection is a non-mandatory requirement and it is therefore proposed not to introduce it in this modification. Essentially, whilst DCC doesn't state we need LVDD schemes, it does specify the requirements necessary should it be introduced.

Low voltage demand disconnection at new sites only is likely to be of limited benefit for the System. To be effective, LVDD needs to be consistently applied across the whole system and therefore would need to be addressed as a separate GB work group.

It has been recognised that should low voltage demand disconnection be introduced into GB in the future, it would need to be introduced via the GB Grid Code Governance process and would need to be consistent with the requirements of DCC in respect of new sites only and the fundamental principles of the DCC would need to be reflected in any future GB legal drafting.

Article 20 - Power Quality

Article 20 of DCC covers the level of distortion and fluctuation in supply voltage at Grid Supply Points. In summary this relates to the tolerable level of harmonics, flicker and unbalance at each Grid Supply Point.

The GB Grid Code already covers these elements in CC.6.1.5, CC.6.1.6 and CC.6.1.7. As a consequence there is no need to change these requirements and the proposal is simply to apply copy these requirements across into the ECC's.

Article 21 - Simulation Models

In order to design and operate the Transmission System, it is an essential requirement that true and accurate models of the plant as built are submitted to National Grid and Network Operators. Under the Grid Code Planning Code, data models are already required to be provided by Network Operators and Non-Embedded Customers for this very purpose.

Most of the data required for demand modelling purposes is already covered in the Grid Code planning code; however the Planning Code has been updated to ensure consistency with DCC.

Operational notification procedure for new connection of transmission-connected demand facilities, transmission-connected distribution facilities and distribution systems

The following articles of DCC detail the operational notification procedure for complying with the technical requirements listed in articles 12-21:

- General provisions (Article 22)
- Energisation Operational Notification (Article 23)
- Interim Operational Notification (Article 24)
- Final Operational Notification (Article 25)
- Limited Operational Notification (Article 26)

Article 22 – General Provisions

DCC States that if any of the requirements in Articles 12-21 apply to a demand facility or system, they must follow the operational notification procedure to show the TSO they are compliant.

The Compliance Processes section of the Grid Code outlines the general compliance process for generation and demand. It is however true to say that the Compliance Processes section within the current GB Grid Code is largely biased towards generation. Due to the requirements in DCC, it is necessary to update the European Compliance Processes section of the code (as developed under GC0102) to specifically capture the compliance processes applicable to transmission connected demand at new sites, which traditionally have only been previously completed through the commissioning process. This applies to articles 23 – 26.

To summarise, the notifications below are currently well established for Generators, however, as it stands in GB currently, only the EON applies to

demand. DCC introduces these notifications as mandatory for new demand connections to the transmission network so most of the articles below can be considered as new requirements.

Article 23 - Energisation Operational Notification (EON)

An EON allows the demand facility owner or DNO to energise its internal network and auxiliaries by using the transmission connection specified for the connection point. In essence this is the same as the EON that would apply to a Generator where the User's plant and Apparatus is connected to the Transmission System for the first time. This activity is completed at the Commissioning Stage and takes place once all the pre checks are complete such as relevant data and site responsibility schedules etc.

Article 24 - Interim Operational Notification (ION)

As defined under the DCC an ION allows the demand facility owner or DNO operate using the transmission connection for a limited period of time.

Article 24 lists a number of items the TSO can request with regard to the data and study review for an ION. These include, for example, an itemised statement of compliance, detailed data submission, equipment certificates (as applicable where these are relied upon as a statement of compliance, simulation models, simulation studies and the approach to compliance testing.

In the case of a Generator, the EON is issued to allow a connection to the Transmission System and hence energise systems / auxiliaries whereas the ION enables synchronisation for the first time.

In the case of demand it is anticipated that the EON and ION will most likely be issued at the same time, as DCC Articles 12 – 21 relate to transmission connected demand or which most aspects are covered at the commissioning stage.

Article 25 - Final Operational Notification (FON)

Under DCC, a FON allows the Transmission Connected entity, be this a DNO or Non Embedded Customer, to operate its demand connection at the Connection Point. Putting this another way it is effectively a statement issued by National Grid confirming that the Network Operator or Non Embedded Customer has satisfied the requirements of the Grid Code and Bilateral Connection Agreement and the data provided is a true and accurate reflection of the plant as built. The issue of a FON will be dependent upon the submission of all necessary data associated with the connection – for example the final statement of Compliance, updated technical data, simulation models, studies and validation of test results against submitted models.

Article 26 - Limited Operational Notification (LON)

Under DCC where a demand facility owner or DNO who has received a FON, they must notify the TSO under certain circumstances specified in Article 26 – for example their plant is temporarily subject to a significant modification or loss of capability affecting its performance or equipment failure leading to non-compliance. Under these circumstances the Network Operator or Non-Embedded Customer will be required to apply for a LON if the issue persists for more than three months.

The LON in many ways applies similar conditions as the ION, with issues such as unresolved issues being identified and the time period required for resolution. Should these issues remain unresolved then an application for a derogation can be sought.

Technical requirements of new Demand Units used by a Demand Facility or a Closed Distribution System to provide Demand Response Services to System Operators

The following areas of modification affect Connection requirements of new Demand Units used by a Demand Facility or a Closed Distribution System to provide Demand Response Services to System Operators:

The general provisions for Demand Response are covered in DCC Article 27. It is important to note that these requirements are not mandatory unless a party wishes to provide Demand Response and a contract has been agreed with the System Operator (i.e. National Grid or a DNO) The general provisions for Demand Response are listed below.

- Specific provisions for demand units with demand response active power control, reactive power control and transmission constraint management (Article 28)
- Specific provisions for demand units with demand response system frequency control (Article 29)
- Specific provisions for demand units with demand response very fast active power control (Article 30)

There were numerous discussions around the correct vehicle to facilitate these new requirements as they do not currently exist in the GB frameworks. For example, a party who offers to provide a Demand Response Service need not necessarily be a CUSC party and obliged to meet the requirements of the Grid Code. After discussing this issue with the workgroup and presenting it at both the Power Responsive Flexibility Forum in January 2018 and the 2018 C16 workshop, feedback was requested from stakeholders and customers. The advantages and disadvantages of the options were presented and circulated to the Workgroup for their comment and feedback. The decision was between putting the requirements in Standard Contract Terms (and the categories stated in C16) or putting the requirements in the Grid Code. The table circulated to the workgroup is shown in Annex 1 and summarises the advantages and disadvantages of both options.

Following these presentations and discussions, the majority of industry parties favoured the requirements to go into the Grid Code, however, those in favour of the standard contract terms option stated they were concerned that the requirements would not be easily found and so the proposed solution is to create a separate and standalone section in the Grid Code for these requirements (and the corresponding compliance) which customers will be directed to via their contract. The Grid Code will therefore be updated in line with this view and a new section of the Grid Code will be introduced entitled Demand Response Services Code.

It is important to note that those parties who offer demand response services will still need to comply with the C16 process and the standard contract terms, however

the technical and compliance requirements of DCC will lie in the Grid Code and the Standard contract terms will refer to these requirements as a condition of the contract. For the avoidance of doubt, parties who offer demand response services need only to satisfy the requirements of this new section of the Grid Code alone (i.e. the Demand Response Services Code), they do not need to satisfy other sections of the Grid Code unless either referred to in the Demand Response Services Code, as a condition of the Standard Contract Terms or if they are User's and hence CUSC parties in their own right.

Article 27 – General Provisions

Five categories are listed that demand services must be grouped into (although DCC states that these are not exclusive and so other categories can be developed). The five categories listed are:

Remotely controlled:

- Demand response active power control;
- Demand response reactive power control;
- Demand response transmission constraint management.

Autonomously controlled:

- Demand response system frequency control;
- Demand response very fast active power control.

In summary these requirements are new to the Grid Code and will be added to the Demand Response Services Code.

Distribution companies do not manage system frequency so DNOs will not be procuring Demand Response System Frequency Control or Demand Response Very Fast Active Power Control. There is therefore no accommodation needed in Distribution documents for these services nor is accommodation for Demand Response Transmission Constraint Management required.

For more information on the Distribution Code impact please refer to their consultation which can be located here:

<http://www.dcode.org.uk/consultations/open-consultations/>

Article 28 - Specific provisions for demand units with demand response active power control, reactive power control and transmission constraint management

Demand units providing the services specified in this article must meet certain technical requirements, including the capability to operate across the frequency ranges specified, be equipped to receive instructions, and be capable of controlling power consumption from the network, to name a few examples. Again these are new requirements and will be added to the Demand Response Services Code.

This section does require the specification of certain technical parameters such as rate of change of frequency. The proposal is to set this at 1Hz/s over a 500ms timeframe which would be consistent with that for Generators as defined under

GC0101. For connections below 110kV, the same demand response requirements would apply to connections at 110kV or above whilst noting that such parties are expected not to be Users as defined under the Grid Code and therefore not subject to the full Grid Code requirements.

In the Distribution Code, the technical requirements of Art 28 are all new and have been added to the new requirements of DPC9.

For more information on the Distribution Code impact please refer to their consultation which can be located here:

<http://www.dcode.org.uk/consultations/open-consultations/>

Article 29 - Specific provisions for demand units with demand response system frequency control

Demand units providing frequency control must meet certain technical requirements, including the capability to operate across the frequency and voltage ranges specified, be equipped with a controller that measures the actual system frequency, and be capable of detecting a change in system frequency of 0.01 Hz, to name a few examples. These requirements only apply if the party wishes to offer these services and will be added to the Demand Response Services Code as a new item.

This section does require the definition of certain technical parameters such as deadband and control system functionality. It is proposed to adopt the same requirements as that applied to Generation. In the case of deadband it is proposed to set this to $\pm 0.015\text{Hz}$. The maximum frequency deviation requirements will be based on a proportional control such that the wider the frequency deviation the greater the response provided until a cap is reached which would be subject to the availability of the demand response service. All other requirements would be as per Article 29 of DCC.

For connections below 110kV, the same demand response requirements would apply to connections at 110kV or above whilst noting that such parties are expected not to be Users as defined under the Grid Code and therefore not subject to the full Grid Code requirements.

Article 30 - Specific provisions for demand units with demand response very fast active power control

The relevant system operator may agree on a contract with demand units providing very fast active power control. If they do, it must include the response time, a change of active power related to a measure and the operating principle of the control system.

In summary such requirements would be pursuant to the terms of the Contract with National Grid. The new Demand Response Services Code has been updated to include this requirement as a non-mandatory service.

Operational notification procedure for new Demand Units used by a Demand Facility or a Closed Distribution System to provide Demand Response Services to System Operators

The following articles of DCC detail the operational notification procedure for complying with the technical requirements listed in articles 27-30:

- General provisions (Article 31)
- Procedures for demand units within a demand facility or a closed distribution system connected at a voltage level of or below 1000 V (Article 32)
- Procedures for demand units within a demand facility or a closed distribution system connected at a voltage level above 1000 V (Article 33)

Article 31 – General provisions

Article 31 sets out the provisions demand unit owners must adhere to and specifies that the operational notification procedure differs for connections above a voltage level of 1000V and those at or below 1000V.

All these requirements are new and will therefore be added to the Demand Response Services Code which is a new non mandatory section of the Grid Code applying only to Demand Response providers.

Article 32 - Procedures for demand units within a demand facility or a closed distribution system connected at a voltage level of or below 1000 V

It is specified that the operational notification will be in the form of an installation document and that a template shall be provided by the relevant system operator. It goes on to list a number of items that must be included in this installation document for example the location of connection, maximum capacity, type of demand response service, Equipment Certificates / Demand Unit Certificate or equivalent information and contact details.

Again these will be new elements added to the Demand Response Services Section of the Grid Code.

Article 33 - Procedures for demand units within a demand facility or a closed distribution system connected at a voltage level above 1000 V

It is specified that the operational notification will be in the form of a Demand Response Unit document (DRUD). The contents will include a statement of compliance (in relation to articles 36 to 47) and will lead to a FON.

These will be new elements added to the Demand Response Services Section of the Grid Code.

Compliance

The purpose of the Compliance section is to ensure that the plant built is fully capable of meeting the requirements specified in DCC. Compliance is a key method of ensuring the data and models provided reflect the true and accurate performance of the equipment as built, this being a fundamental prerequisite for the design and operation of the System going forward.

Compliance covers three main areas. These are summarised as follows:-

- i) The Compliance Process (i.e. the process by which parties demonstrate their plant can meet the requirements of the codes)
- ii) Simulation (the submission of plant performance based on simulations)
- iii) Testing (Plant testing - validation of actual test results against simulated results)

The following articles of DCC relate to compliance:

Article 34 – Responsibility of the demand facility owner, the distribution system operator and the closed distribution system operator

This section of DCC discusses the general requirements on demand facility owners, the distribution system operators and the closed distribution system operators for ensuring compliance with DCC.

Under the legal text, any demand or distribution customer who has a CUSC contract (e.g. A Network Operator or Non-Embedded Customer) will have to satisfy the compliance requirements of the European Compliance Processes (ECPs) and Demand Response Providers who are not necessarily CUSC parties will have to satisfy the compliance requirements in the DRSC. It is possible that a Demand Response Provider could also be a User (as defined in the Grid Code) in which case the requirements of the ECPs and the DRSC will apply.

Article 35 - Tasks of the Relevant System Operator

Article 35 relates to the tasks of the Relevant System Operator in ensuring that Users and Demand Response Providers comply with the requirements of DCC. As outlined above with regard to Article 34, the compliance obligations on the Relevant System Operator for Users is outlined in the ECPs and the compliance obligations on the Relevant System Operator for Demand Response Providers is outlined in the DRSC.

For demand response services provided to National Grid by distribution connected parties, National Grid will take the lead in the compliance process, with co-operation as necessary by the relevant DNO.

Articles 36 to 45 - Compliance testing and simulations

The titles of these Articles are as follows:

- Common provisions for compliance testing (Article 36)
- Compliance testing for disconnection and reconnection of transmission-connected distribution facilities (Article 37)
- Compliance testing for information exchange of transmission-connected distribution facilities (Article 38)
- Compliance testing for disconnection and reconnection of transmission-connected demand facilities (Article 39)
- Compliance testing for information exchange of transmission-connected demand facilities (Article 40)
- Compliance testing for demand units with demand response active power control, reactive power control and transmission constraint management (Article 41)
- Common provisions on compliance simulations (Article 42)

- Compliance simulations for transmission-connected distribution facilities (Article 43)
- Compliance simulations for transmission-connected demand facilities (Article 44)
- Compliance simulations for demand units with demand response very fast active power control (Article 45)

For Articles 36 to 45, the legal text has been drafted using the same principles adopted for Articles 34 and 35 in which the testing and simulation requirements for Users are defined in the ECPs and for Demand Response Providers are defined in the DRSC.

Articles 46 and 47 - Compliance monitoring

The Article titles are as follows:

- Compliance monitoring for transmission-connected distribution facilities (Article 46)
- Compliance monitoring for transmission-connected demand facilities (Article 47)

These requirements only apply to Users (Network Operators and Non-Embedded Customers) and therefore, only the legal text in the ECPs has been updated to reflect these requirements.

Glossary and Definitions

Following discussions around some of the definitions with members of the workgroup, a few have been changed, in particular, EU Grid Supply Point, to more accurately reflect the requirements in DCC.

After reviewing WACM1, the definition of ‘Substantial Modification’ was also updated to reflect the use of the phrase “impacting technical capabilities” to align it more closely to the alternative suggested following stakeholder feedback. Notwithstanding this, the alternative still remains as the Original solution does not reflect the criteria relating to the determination by the Regulatory Authority of whether an existing installation becomes subject to DCC due to being substantially modified. It was not considered to be necessary to require Ofgem to make decisions for every “new” case, it would create inefficiencies in the process and by adding an extra stage would inevitably lead to longer decision turnaround times as the decision would have to be initially made by National Grid to determine if it is considered Substantial and then passed to the Authority to make a second decision - while the Connection Codes do refer to NRA approval, any GB connection agreement in dispute can be referred to Ofgem under Transmission Licence Condition C9 ‘Functions of the Authority’, which discharges the obligations of DCC as Ofgem’s decision is implicit providing both parties are in agreement.

Some of the DRSC related definitions were also updated for clarity following workgroup consultation responses and workgroup discussions – including Ancillary Services and Demand Response Services.

The definition of Demand Response Provider was also updated as there was some confusion for aggregators in the previous definition, so it now includes “own, operate, control or manage”. This change will provide clarity that the definition of Demand Response Provider equally applies to owners of Demand Units who provide a Demand Response Service or simply aggregators who control a range of Demand Units on behalf of another party and provide a Demand Response Service on aggregate.

A minor change to section (d) of the definition of a GB Code User was introduced to make it clear that a Network Operator would still be classed as a GB Code User if it had one or more EU Grid Supply Points, but still has one or more GB Grid Supply Points connected to the Transmission System as part of its existing Distribution System. It should be noted that a User’s type (e.g. EU Code User or GB Code User) will be specified in new bilateral connection agreements.

It was also noted that the compliance deadline in Article 59 of the DCC (referring to when the Code will apply) relates to the date of publication and not entry into force – therefore 7 September 2019 has now been amended to 18 August 2019 in the applicable definitions.

Demand Response Services Code (DRSC)

Following consultation responses it was noted that the DRSC would cause confusion to aggregators and some demand providers. An effort was made to liaise closely with these parties to make the DRSC more user-friendly and ensure it ties in with Standard Contract Terms (SCTs).

In light of this, a guidance note has been prepared in slide format, and circulated to workgroup members ahead of the GC0104 vote. This will further be developed into a more formal guidance note to ensure the linkage between the SCTs and DRSC is clear. It was decided that because a guidance note would be produced, some of the Appendices that were originally included in the legal text would be more suitable in a guidance note as they didn't list any requirements but were instead adding context and assistance.

References to Balancing Service as a defined term have also been removed to try and prevent confusion.

The main comments from the consultation with regards to the DRSC were around making sure the complexity of it wasn't creating barriers to entry so the majority of the redrafting has been around simplifying the text, tying it more closely to the SCTs and considering how this might work with the guidance note so that Demand Providers do not have to refer to several different documents. In addition, to ensure the code is efficient, the proposer noted that if this linkage was not clear it would result in significant duplication of text between the Standard Contract Terms and Grid Code, which could cause significant confusion.

The Standard Contract Terms will also be updated to reflect the link to the DRSC.

Planning Code (PC), Connection Conditions (CC), European Connection Conditions (ECC), Data Registration Code (DRC) and European Compliance Process (ECP)

These sections had minor amendments (mostly grammatical) following consultation responses and suggestions from workgroup members.

8 Impacts and Other Considerations

- i. *The Grid Code and Distribution Code will bear the primary impact of the EU Connection Code mods.*
- ii. *The Transmission/Distributions connections and compliance processes will need to be slightly altered to ensure they accommodate the new EU requirements as set out in the modified Grid Code and Distribution Codes.*
- iii. *No system changes are anticipated as a result of implementing the EU Connection Codes*

Does this modification impact a Significant Code Review (SCR) or other significant industry change projects, if so, how?

The EU Network Code implementation is being undertaken as a significant programme of work within the GB industry. This modification forms part of that programme, but is not part of an on-going SCR.

Consumer Impacts

This modification implements consistent technical standards across the EU for the connection of new transmission-connected Demand facilities, new transmission-connected distribution facilities and new distribution systems, including new closed distribution systems. It also addresses the performance requirements for new demand units used by a demand facility or a closed distribution system to provide Demand Response to relevant system operators and relevant TSOs. This should lead to efficiencies and potential cost savings for stakeholders.

The Demand Side Response provisions should also improve market access for new entrants, leading to greater levels of competition, which should lead to lower costs for end consumers.

The Workgroup, on the 23 January 2018 noted the cross over with GC0106 in Article 53 of SOGL (System Operator Guideline). This interaction was noted and the Workgroup agreed that this would be made clear within the legal text for the two consultations across the two modifications.

9 Workgroup Discussions – Initial four Workgroup meetings

The GC0104 Workgroup met on four occasions ahead of issuing this Workgroup Consultation paper to seek wider Industry views on the proposed draft solution from the Proposer. The Workgroup have not yet discussed any potential alternatives to the proposed Original solution but welcome any potential alternatives being raised by Industry for discussion at future Workgroup meetings following the Workgroup Consultation.

Any potential alternative option(s) will be considered by the Workgroup and if the potential alternative(s) is supported by a majority of the Workgroup (or the Workgroup chair) because they believe it better meets the Applicable Grid Code Objectives as compared to the Original then the potential alternative will be taken forward as a formal Alternative to the Original proposal (meaning that they will be

worked up, legal text prepared and, ultimately, they will be available for Ofgem to approve, if appropriate, and implemented).

At the initial Workgroup meeting, held on 6 September 2017 the Proposer talked through the slides that they had produced outlining their view of the defect for new Transmission Connected Demand, new Transmission Connected Distribution Facilities plus new Distribution Systems and the proposed structure for progressing the piece of work. The slides can be found at the following link:

<https://www.nationalgrid.com/uk/electricity/codes/grid-code/modifications/gc0104-eu-connection-codes-gb-implementation-demand>

At the second Workgroup meeting, held on the 6 December 2017 the Proposer talked through DCC Compliance and the slides that can be found at the following link labelled 6 December presentation:

<https://www.nationalgrid.com/uk/electricity/codes/grid-code/modifications/gc0104-eu-connection-codes-gb-implementation-demand>

The Proposer also talked through the two options which can be found in Annex 1 that they believed were available to produce a solution to the defect and sought feedback from the Workgroup on this. A Workgroup member noted that there was another (third) option. These options and table that was circulated for review by the Proposer can be found at Annex 1.

At the third Workgroup meeting, held on the 23 January 2018 the Workgroup discussed the following agenda items:

- Annex 1 options table and the solution adopted by the Proposer as their preferred option based on stakeholder feedback provided
- Interpretation of a new DNO GSP

C16 & SCTs vs. Grid Code

The Proposer outlined the engagement that they had carried out to form their proposed solution to the defect. This included presentation at the Proposer's 'Power Responsive Flexibility Forum'. The presentation that the Proposer gave can be found on the GC0104 area of the National Grid website. In addition the Proposer asked the GC0104 Workgroup and the C16 Workshop for feedback.

The Proposer stated that they would, as a result of the feedback that had been provided by both the GC0104 Workgroup and additional forums be proposing to amend the Grid Code. This proposed solution (the Original) can be located in the Solution Section of this Consultation (Section 6) document.

The Proposer went on to outline that they have sought to address the feedback from the respondents and have proposed a new section of the Grid Code for Demand Response services to prevent those not obligated to review the Grid Code to access their obligations, should they provide the service, quickly and in the most simple and transparent way possible.

The governance arrangements of the C16 documentation was highlighted by a Workgroup member; they stated that the C16 process is not subject to open and transparent governance (unlike the Grid Code and CUSC). The C16 process means that amendments cannot be made by Users, Citizens Advice or other parties (such as trade associations or other groups of interested parties) designated as a 'Materially Affected Party by Ofgem as they can be by the Grid Code and CUSC through their Open Governance Rules.

Commercial impacts and discussions

A Workgroup member raised concerns around a lack of details about the commercial framework for the Demand Connection Code (DCC) as the proposed contractual approach set out by the Proposer was neither harmonised or open and transparent. The Workgroup member noted that without this clarity on the harmonised rules for grid connection of demand facilities and distribution systems (as well as for demand side response provided to relevant network companies) then the implementation of the DCC would not be completed for GB.

The Proposer stated that the GC0104 Workgroup had been formed to address the Defect that the Grid Code was not compliant with DCC requirements and that the commercial arrangements for Demand Side Response services fell outside the scope of this modification, as stated in the original Modification Proposal that was presented to and accepted by the Grid Code Review Panel. It was noted that a separate team within National Grid are responsible for administering the contracts process. The Code Administrator took an action to make the CUSC Panel Secretary aware of this piece of work. The Proposer stated that this modification identified the defect of the technical aspects of the Demand Connection Code. The Code Administrator has completed the action above following meeting.

A Workgroup member noted the wording outlined in Article 58 (1) and (2):

Amendment of contracts and general terms and conditions

1. Regulatory authorities shall ensure that all relevant clauses in contracts and general terms and conditions relating to the grid connection of new transmission-connected demand facilities, new transmission-connected distribution facilities, new distribution systems and new demand units are brought into compliance with the requirements of this Regulation.
2. All relevant clauses in contracts and relevant clauses of general terms and conditions relating to the grid connection of existing transmission-connected demand facilities, existing transmission-connected distribution facilities, existing distribution systems and existing demand units subject to all or some of the requirements of this Regulation in accordance with paragraph 1 of Article 4 shall be amended in order to comply with the requirements of this Regulation. The relevant clauses shall be amended within three years following the decision of the regulatory authority or Member State as referred to in Article 4(1).

The Workgroup member stated that the requirement in the DCC was to have harmonised rules for connection. This meant that the contractual arrangements

needed to be identical in the cases of (i) new Transmission Connected Demand, (ii) new Transmission Connected Distribution Facilities plus (iii) new Distribution Systems. If local circumstances warranted a change then the prescribed DCC derogation procedure would need to be followed.

The Workgroup went onto discuss what amendments could possibly be required in respect of the Distribution System. In terms of Demand response, the Distribution Code representative noted that they did not have the equivalent to the C16.

It was noted that where Demand Response was being provided to a relevant system operator who was not a TSO (which was expected to be new demand unit used by a demand facility to provide Demand Response to a distribution system operator) then a new template could be added to the DCUSA. A Workgroup member noted that the Rules and Regulations need to be the same.

Another Workgroup member stated that the solution to the defect identified needs to ensure it does not cause any barriers to entry. The Proposer stated that they were attempting to, within their solution, ensure the process proposed is as simple as possible for Industry to understand and follow.

Additionally a Workgroup member noted that when drafting the Demand response requirements across the Grid and Distribution Codes that consistency would be required between the DSO and TSO.

Interpretation of a new DNO GSP

The Proposer for GC0104 asked the following question of the Workgroup and requested a discussion on this element of the modification:

- If a DNO upgrades it's Grid Supply Point to the point that the connection agreement needs to be significantly revised, our understanding is that the DCC extends only to that GSP not the DNO as a whole?
- Is this interpretation correct?
- Is there anything else we need to consider?

A Workgroup member stated that EONs and IONs would apply and that compliance comes from the combination of GSP and distribution system, not necessarily one or the other.

Another Workgroup member talked through an example of the equivalent situation at either a power station or existing demand facility and referred to Article 4 (1) (a) and (b) of the DCC :

“1. Existing transmission-connected demand facilities, existing transmission-connected distribution facilities, existing distribution systems and existing demand units that are or can be used by a demand facility or a closed distribution system to provide demand response services to a relevant system operator or relevant TSO, are not subject to the requirements of this Regulation, except where:

(a) an existing transmission-connected demand facility, an existing transmission-connected distribution facility, an existing distribution system, or an existing

demand unit within a demand facility at a voltage level above 1 000 V or a closed distribution system connected at a voltage level above 1 000 V, has been modified to such an extent that its connection agreement must be substantially revised in accordance with the following procedure:

(i) demand facility owners, DSOs, or CDSOs who intend to undertake the modernisation of a plant or replacement of equipment impacting the technical capabilities of the transmission-connected demand facility, the transmission-connected distribution facility, the distribution system, or the demand unit shall notify their plans to the relevant system operator in advance; (ii) if the relevant system operator considers that the extent of the modernisation or replacement of equipment is such that a new connection agreement is required, the system operator shall notify the relevant regulatory authority or, where applicable, the Member State; and

(iii) the relevant regulatory authority or, where applicable, the Member State shall decide if the existing connection agreement needs to be revised or a new connection agreement is required and which requirements of this Regulation shall apply; or

(b) a regulatory authority or, where applicable, a Member State decides to make an existing transmission-connected demand facility, an existing transmission-connected distribution facility, an existing distribution system, or an existing demand unit subject to all or some of the requirements of this Regulation, following a proposal from the relevant TSO in accordance with paragraphs 3, 4 and 5.”

A workgroup member stated that the application of the wording across the EU Connection Code Modifications (GC0100, 101, 102 and 104) should be consistent as the wording is identical between the DCC (extract above) and the equivalent Article 4 (1) (a) and (b) in the RfG. They also noted that the wording in DCC Article 4 (1) (a) and (b) indicated that there should be a process where the Regulator is informed. It was additionally noted that there could be an implication for Ofgem that they needed to be made aware of. NGET took an action to speak to Ofgem around this and report back to the Workgroup so that stakeholders were fully aware of the outcome of those discussions.

The Proposer of GC0104 took an action to review the GC102 legal text and propose GC0104 legal text to ensure the application is consistent ahead of the Workgroup meeting ahead of the issuing of the Workgroup Consultation.

Please note that all presentations provided and discussed at the Workgroup meetings can be found at the following link:

<https://www.nationalgrid.com/uk/electricity/codes/grid-code/modifications/gc0104-eu-connection-codes-gb-implementation-demand>

Following the issue being raised with the Authority they provided the following clarity for the GC0104 Workgroup:

In terms of Article 4(1), the working group discussed the issues (eg time delays, resource requirements) associated with Ofgem reviewing and determining whether

parties should be treated as “new” or “existing” in all these cases . This was considered unnecessary where the generator and system operator agreed about its status. We considered that a practical interpretation of Article 4(1) was that we reviewed and decided whether parties should be treated “new” or “existing” where there was a dispute about whether the generator should be treated as “new” or “existing”. This approach was not considered inconsistent with the wording of the RfG.

The Authority understands that there are concerns about the term “substantial modification”. They believe that this term has been derived from the Article 4 (1)

“Existing power-generating modules are not subject to the requirements of this Regulation, except where:

- (a) a type C or type D power-generating module has been modified to such an extent that its connection agreement must be substantially revised in accordance with the following procedure”.*

There were discussions during the working group about the production of an additional document to provide more information to stakeholders about the assessment process under Article 4 (1), so that parties had a better understanding of the type of change that would lead to their generator being treated as “new”. It sounds like this document might be useful.

The Authority would reiterate the message that if there is any concern or dispute about the assessment undertaken by the system operator, then it can be forwarded to us for decision.

Low Voltage Demand Disconnection (LVDD) Article 19 (2)

The Workgroup discussed the proposed solution with respect to LVDD. It was noted that the DCC specifies the requirements necessary for LVDD should it be introduced for GB. That decision will be made by the relevant TSO which, in this case, is NGET. NGET informed the Workgroup that it has no intention of taking up this right at this time.

Therefore, during the workgroup discussions it was noted that should low voltage demand disconnection be introduced into GB in the future, it would need to be introduced via the GB Grid Code Governance process and would need to be consistent with the requirements of DCC in respect of new sites only.

Low voltage demand disconnection at new sites only is likely to be of limited benefit for the System. To be effective, LVDD needs to be consistently applied across the whole system and therefore would need to be addressed as a separate GB work group. That said, if LVDD was introduced in GB in the future, then the fundamental principles of the DCC would need to be reflected in any future GB legal drafting.

Demand Response Services

During the Workgroup meetings there were discussions around the correct vehicle to facilitate these new requirements as they do not currently exist in the GB frameworks. For example, a party who offers to provide a Demand Response Service need not necessarily be a CUSC party and obliged to meet the requirements of the Grid Code. After the Proposer discussed this issue with the Workgroup and presenting it at both the Power Responsive Flexibility Forum in January 2018 and the 2018 C16 workshop, feedback was requested by the Proposer from stakeholders and customers. The advantages and disadvantages of each option, according to the Proposer, were presented and circulated to the Workgroup for their comment and feedback. The decision presented by the Proposer was between putting the requirements in Standard Contract Terms (and the categories stated in C16) or putting the requirements in the Grid Code. The table circulated by the Proposer to the Workgroup is shown in Appendix 1 and summarises the advantages and disadvantages of both options.

A Workgroup member noted that there was a third option which was to put the technical details in the Grid Code and the contractual arrangements in the CUSC. This would allow more stakeholders, as well as groups representing non CUSC parties (such as end consumers) to raise modification proposals to change the contractual terms – this was not possible with the C16 documentation as open governance and the CACoP principles were not applicable (to C16 matters).

Following these presentations and discussions, the majority of industry parties favoured the requirements to go into the Grid Code, however, those in favour of standard contract terms stated they were concerned that the requirements would not be easily found and so the Proposer set out that the solution is to create a separate and standalone section in the Grid Code for these requirements (and the corresponding compliance) which customers will be directed to via their contract. The Grid Code will therefore be updated in line with this view and a new section of the Grid Code will be introduced entitled Demand Response Services Code. A Workgroup member believed that placing the contractual arrangements in the CUSC (rather than the C16 approach) would be better for stakeholders and customers.

The Proposer noted that whilst these commercial arrangements were worth considering, the GC0104 Workgroup had been formed to address the Defect that the Grid Code was not compliant with DCC requirements and that the commercial arrangements for Demand Side Response services fell outside the scope of this modification, as stated in the original Modification Proposal that was presented to and accepted by the Grid Code Review Panel.

The GC0104 Workgroup met on the 22 February to discuss issuing the Workgroup Consultation.

Some Workgroup members expressed that, in their view, some further clarity and work was required ahead of issuing the Consultation to Industry. They stated that this was required as this is the only Consultation within the modification process where Industry can provide their input and potentially influence amendments and raise potential alternatives to the proposed solution.

The following information below has been added to the Consultation following the last Workgroup meeting, following the issues raised:

Workgroup members stated that the Standard Contract Terms needed to be available as part of this Consultation, please find the links to these below:

Firm Frequency Response:

https://www.nationalgrid.com/sites/default/files/documents/FFR%20SCTs%20-%20Issue%208%20Feb%201st%202017_0.pdf

Short Term Operating Reserve:

https://www.nationalgrid.com/sites/default/files/documents/STOR%20Standard%20Contract%20Terms%20Issue%2010%20%28Effective%20from%201%20April%202017%29%20%281%29_0.pdf

Fast Reserve:

<https://www.nationalgrid.com/sites/default/files/documents/Fast%20Reserve%20Tender%20Rules%20and%20Standard%20Contract%20Terms%20-%20Effective%201%20April%202015.pdf>

DRSC

Workgroup members raised some concerns that it wouldn't be clear for demand providers to follow the requirements as the DRSC was referring to other documents within it so the Proposer has amended the legal text following the meeting so it slots into the SCTs and where it does make reference (as sometimes it has to in order to avoid adding extra requirements into it) the requirements are clearer (in the Proposers view) and now easier to find/follow.

Following the discussions at the last GC0104 meeting the Proposer did the following:

GSP

Some Workgroup members were concerned around the definitions of EU Code User and EU Grid Supply Point in that if they modified their GSP (Grid Supply Point) and what would this mean for them.

The Proposer went away and considered the possibilities further and it was clarified by the Proposer that if an existing DNO were to upgrade a GSP (to the extent it became an EU GSP) it would be treated as a Distribution Facility (DCC definition) and that only the GSP would be treated as an EU GSP and the rest of the distribution system would not be treated as a (EU) distribution system as defined in DCC. The Proposer clarified that only the Articles in DCC that applied to Distribution Facilities would be applicable to the EU GSP.

TSO Consultation – Article 9 DCC

A Workgroup member raised concerns around Article 29(d) and whether the Proposer, as TSO has carried out a Consultation. The Proposer felt that the public

consultation included the TSOs and therefore a separate consultation was not necessary.

10 Summary of Workgroup Consultation responses

The Workgroup Consultation closed on the 29 March 2018 and received twelve responses. The full responses can be located in Annex 5. Please note that the response received by Western Power Distribution was not received by the Code Administrator due to technical issues ahead of the meeting held on the 4 April 2018 so it is not included within the summary document. The points raised within response have been addressed by the Proposer and Workgroup.

A presentation providing a summary the responses received can be located in Annex 6 and the discussions that the Workgroup had post Consultation can be located in section 11.

11 Workgroup Discussions following Workgroup Consultation

The GC0104 Workgroup met on the 4 April 2018 to discuss the eleven responses that were submitted in response to the Workgroup Consultation that closed on the 29 March 2018.

The Technical Secretary of the Workgroup talked through a high-level presentation of the responses received which can be located in Annex 6. It was noted that nine of the twelve responses stated that the solution proposed better facilitated the Grid Code objectives and that one respondent outlined that the Proposal was deficient in terms of technical detail which they would expect in this modification.

The Technical Secretary outlined that the respondents were generally supportive of the implementation approach outlined in the Consultation but she noted that there was a response from SSE Generation Ltd which stated that Directive 2015/1535 needed to be taken into account. It was noted that this issue had been raised at the CUSC Panel and Ofgem were requested to put in writing their position on the matter. The Technical Secretary stated that she would inform the GC0104 Workgroup of this position once received.

The Workgroup agreed that the main points for discussion as a result of the Consultation were Questions 9 and 10 and these were then discussed in more detail as outlined below.

Question 9: Can you see any issues with treating GSPs and EU GSP's in the way set out in the Glossary and Definitions and European Connection Conditions of the solution?

- **5/11** No comment
- **4/11** Further clarity required/alternative request
- **2/11** Fit for purpose/no issues

It was noted that Alan Creighton of Northern PowerGrid had submitted a Workgroup Consultation Alternative request as part of the Workgroup

Consultation. This can be located in Annex 5 with the full Consultation responses. The Workgroup discussed and reviewed the proposed legal text that had been put forward. It was explained, as outlined in the form submitted, that the legal text proposed by the Proposer in the Consultation would mean that an existing Grid Supply Point would be treated as an EU Grid Supply Point under the Grid Code and that it should not be treated as such.

The Proposer noted this interpretation when reviewing their proposed legal text and stated that there was the potential to amend their solution based on this feedback.

The Alternative request form can be located in Annex 5. More than fifty percent of the Workgroup supported this suggested alternative being developed and as such this proposed Alternative went forward as WACM1.

Following the Workgroup meeting that was held on the 4 April the Proposer and Proposer of WACM1 discussed the alternative further. The Proposer amended their solution to incorporate the feedback from the Workgroup and the Proposer of WACM1 withdrew their alternative.

Significant Modification Definition (WACM1)

Further to the initial Workgroup discussions (Section 9) on the Significant Modification Definition the Workgroup decided that they would like to raise an Alternative Proposal for the Authority to receive and assess. Alastair Frew agreed to be the Proposer of this proposed alternative which can be located in Annex 7.

All Workgroup members present on the 4 April stated that this potential alternative better facilitated the Grid Code objectives better than the baseline and therefore this became WACM2.

Due to WACM1 being withdrawn as outlined above this is now the only WACM being submitted to the Authority along with the Original for their consideration. Please see Table 1 for more information on the alternatives.

The Proposer of GC0104 stated that they would not alter their solution to the defect due to the fact that they felt that, In the proposer's view, it was not considered to be necessary or efficient to require Ofgem to make decisions in every case - while the Connection Codes do refer to NRA approval, any GB connection agreement in dispute can be referred to Ofgem under Transmission Licence Condition C9 'Functions of the Authority'.

The Proposer of this WACM stated that during the GC0102 Code Administrators Consultation comments were received suggesting that the proposed definition of Significant Modification did not fully represent the legal requirements of the network codes Requirements for Grid Connection of Generators (RfG) EU 2016/631 and Requirements for Grid Connection of High Voltage Direct Current Systems (HVDC) EU 2016/1447. The GC0102 proposal has progressed and is now with the Authority for final determination. This modification proposal GC0104 deals with the Network Code on Demand Connection (DCC) EU 2016/1388 which

has the same legal requirements as other two EU network code² and whilst initially the Original proposal was to use the same definition of Significant Modification as previously set in GC0102 the Original proposal has now been changed to partially match this Alternative proposal, however the majority of Workgroup members believed it did not cover all requirements. The Alternative proposal changed the definition of Significant Modification to be more representative of the legal requirements of the DCC and as a consequence the majority of Workgroup members believed it would also improve compliance with the RfG and HVDC requirements. More details on this can be located in the Alternative form at Annex 7 including the legal text proposed.

Table 1: WACMs

Proposed alternatives	Title	Workgroup Vote	WACM number		
1	Clarifying the application to existing Grid Supply Points	More than 50% agreed to take forward as formal alternative	WACM1	Withdrew following Proposer update to solution	Withdrawn
2	Significant Modification Definition	More than 50% agreed to take forward as formal alternative	WACM2	Continued as WACM1 due to withdrawal of alternative above.	WACM1

Q10. Do you agree that the DRSC reflects the requirements of DCC and provides sufficient information for Demand Response Providers. If not, please state why do not believe this to be the case and what you believe would provide a better alternative.

- 1/11 ADE response to be reviewed
- 3/11 No comment
- 5/11 Yes plus one comment around DRSC A.2 - Excess of what is required in DCC? (ENWL)
- 2/11 No – Not enough detail to understand obligations, more documents to read rather than in one place. Obligations in DRSC could be put in SCTs to avoid this (Flextricity) No - Ancillary Service Agreement Governance an issue and also this modification should be the whole package and is not – does not reflect requirements (SSE)

The Workgroup reviewed the responses to question 10 above. It was noted by the Workgroup and Proposer that more could be done to assist in understanding the obligations. The Proposer agreed to produce Guidance on where all the documentation can be located and this can be found at Annex 8. The Proposer

² Set out in Article 4 of the three respective Regulations.

stated that moving or adding further information to the DRSC section would duplicate information and in addition would be more than required within the scope of this modification. The majority of Workgroup members were happy with the proposal for further guidance to be produced to assist Industry with the transition to the new requirements and improve the linkage between the SCTs and the DRSC. The DRSC was also updated following conversations between the Proposer and some stakeholders who would be using that section of the Grid Code in an effort to make it more user-friendly.

System Operation Guideline

A Workgroup member noted that there was a connection between the Demand Connection Code requirements and that of the System Operation Guideline and that once implemented into the Grid Code together this would provide the User with a picture of all the requirements. It was noted that a modification had not yet been raised to address the areas (Articles 155, 159 and 162) within SOGL that the Workgroup member stated needed to be done. Following this Workgroup meeting National Grid have raised a modification on the Pre-Qualification requirements. More information on this can be located in GC0114.

12 Workgroup Vote

The Workgroup met on the 23 April 2018 to carry out the Workgroup Vote. The Workgroup voted that, by majority WACM1 better facilitates the Grid Code objectives.

Vote 1 – does the original or WACM facilitate the objectives better than the Baseline?

Vote recording guidelines:

“Y” = Yes

“N” = No

“-“ = Neutral

Workgroup Member	Better facilitates AGCO (i)	Better facilitates AGCO (ii)?	Better facilitates AGCO (iii)?	Better facilitates AGCO (vi)?	Better facilitates AGCO (v)?	Overall (Y/N)
Mike Kay						
Original	-	-	-	Y	-	Y
WACM1	-	-	-	Y	N	Y
Voting Statement: The original and the WACM both enable the complete discharge of the DCC requirements. They have little other effect on the overall operation of the Grid and Distribution Codes. WACM1 introduces an unnecessary bureaucratic step that is already adequately and compliantly covered in the Transmission and Distribution licences.						
Timothy Moore						
Original	Y	Y	Y	N	-	Y
WACM1	Y	Y	Y	Y	-	y
Voting Statement:						

WACM 1 more clearly defines The Authorities responsibility for deciding if existing facilities will need comply with new European Connection Conditions. The original proposal is unclear, but it could be interpreted that it is NGET responsibility.

Garth Graham

Original	Y	Y	Y	N	-	Y
WACM1	Y	Y	Y	Y	-	Y

Voting Statement:

Alan Creighton

Original	Y	Y	Y	Y	-	Y
WACM1	Y	Y	Y	Y	-	Y

Voting Statement: Both the Original and the WACM1 are better than the baseline in that they implement the EU DCC Network Code, they promote competition in that they harmonise the provision of demand side service requirements and hence help improve overall efficiency.

Alastair Frew

Original	Y	Y	Y	N	-	Y
WACM1	Y	Y	Y	Y	-	Y

Voting Statement:
The original does not fully discharge all the legal requirements of the European Regulations

Rachel Woodbridge-Stocks

Original	Y	Y	Y	Y	-	Y
WACM1	Y	Y	Y	Y	-	Y

Voting Statement: Both the Original Proposal and the WACM better facilitate the Grid Code objectives than the baseline as they both implement DCC, however, WACM1 seems to be a less efficient and practical implementation solution than the Original.

Tim Ellingham

Original	Y	Y	N	N	N	N
WACM1	Y	Y	Y	Y	Y	Y

Voting Statement: The original fails to accurately implement the EU code in relation to existing plant which would limit investment in existing plant impacting efficiency and potentially power levels leading to a decrease in security of supply. The original will also likely increase the number of referrals to the Authority.

Saskia Barker

Original	-	-	-	Y	-	Y
WACM1	-	-	-	Y	-	Y

Voting Statement: Both the original and WACM1 better facilitate the Grid Code Objectives as they both discharge the TSO's obligations under the DCC. That said, it is important that the implementation of these changes is sensible and that they are clearly articulated to DSR providers in clearer, more precise language in the appropriate places, for example guidance on a per service basis that is kept in the same place at the STCs for the service.

Graeme Vincent

Original	Y	-	-	-	Y	Y
WACM1	Y	-	Y	Y	Y	Y

Voting Statement:

Believe Original and WACM are better than baseline and WACM adds further clarity over original.

Vote 2 – Which option is the best?

Workgroup Member	BEST Option?
Mike Kay	Original
Timothy Moore	WACM1
Garth Graham	WACM1
Alan Creighton	WACM1
Alastair Frew	WACM1
Tim Ellingham	WACM1
Saskia Barker	WACM1
Graeme Vincent	WACM1
Rachel WoodbridgeStocks	Original

13 Relevant Objectives - assessment by Proposer

Impact of the modification on the Grid Code Relevant Objectives:	
Relevant Objective	Identified impact
To permit the development, maintenance and operation of an efficient, coordinated and economical system for the transmission of electricity	Positive
To facilitate competition in the generation and supply of electricity (and without limiting the foregoing, to facilitate the national electricity transmission system being made available to persons authorised to supply or generate electricity on terms which neither prevent nor restrict competition in the supply or generation of electricity)	Positive
Subject to sub-paragraphs (i) and (ii), to promote the security and efficiency of the electricity generation, transmission and distribution systems in the national electricity transmission system operator area taken as a whole	Positive
To efficiently discharge the obligations imposed upon the licensee by this license and to comply with the Electricity Regulation and any relevant legally binding decisions of the European Commission and/or the Agency; and	Positive
To promote efficiency in the implementation and administration of the Grid Code arrangements	Neutral

DCC is one of the eight EU Connection Codes which derive from the Third Energy Package legislation; focused on delivering security of supply; supporting the connection of new renewable plant; and increasing competition to lower end consumer costs. It therefore directly supports the first three Grid Code objectives.

Furthermore, this modification is to ensure GB compliance of EU legislation in a timely manner, which positively supports the fourth Grid Code applicable objective.

14 Implementation

This modification must be in place to ensure the requirements of DCC are set out in the GB Grid and Distribution codes *by* two years from Entry into Force - 7 September 2016 – which means it will need to be in place by 7th September 2018.

It is therefore crucial that this work is concluded swiftly to allow the industry the maximum amount of time to consider what they need to do to arrange compliance.

15 Code Administrator Consultation: How to respond

If you wish to respond to this Code Administrator Consultation, please use the response pro-forma which can be found under the 'Industry Consultation' tab via the following link;

<https://www.nationalgrid.com/uk/electricity/codes/grid-code/modifications/gc0104-eu-connection-codes-gb-implementation-demand>

Responses are invited to the following questions;

1. Do you believe GC0104 better facilitates the Grid Code Objectives? Please include your reasoning.

2 Do you support the proposed implementation approach?

3. Do you have any other comments?

Views are invited on the proposals outlined in this consultation, which should be received by **5pm on 08 June 2018**. Please email your formal response to: grid.code@nationalgrid.com

If you wish to submit a confidential response, please note the following;

Information provided in response to this consultation will be published on National Grid's website unless the response is clearly marked 'Private & Confidential', we will contact you to establish the extent of this confidentiality. A response marked 'Private & Confidential' will be disclosed to the Authority in full by, unless agreed otherwise, will not be shared with the Grid Code Modifications Panel or the industry and may therefore not influence the debate to the same extent as a non-confidential response.

Please note an automatic confidentiality disclaimer generated by your IT System will not in itself, mean that your response is treated as if it had been marked 'Private & Confidential'

Annex 1 Demand Response table

This table was circulated as produced below, by the Proposer (unchanged), to the GC0104 Workgroup for their views. A further option (3) was suggested by a Workgroup member and is included below:

Option	Advantages	Disadvantages	Timescales	How commerciality and compliance would fit
Technical requirements in Grid Code, commercial facilitation in contracts/C16	Fully transparent with a number of public consultations to develop	Not efficient to implement; still requires changes to contracts as well as Grid Code	Open Governance – would follow Grid Code process timescales (approximately 6 months). Other Grid code changes will be progressing at the same time though.	<p>Commerciality – would go in contracts and refer parties to the Grid Code for technical requirements including compliance.</p> <p>It is envisaged that reciprocal arrangements would be required in the D Code.</p> <p>Putting it another way the commercial contract would set out the services required, a condition of the contract would then specify the technical and compliance requirements required of the Grid Code with similar arrangements in for the D Code.</p>
		Not all demand users currently need to abide by Grid Code and are not CUSC parties– not user friendly		
Technical requirements and commercial facilitation in standard contract terms/C16	Simplifies arrangements; only requires changes to contracts	Not codified	Consultation process as set out in Licence, requires two 4 week periods of consultation followed by Ofgem approval.	Commerciality – commercial and technical requirements would all be in one contract.
	Requirements can't be changed by parties not affected by DCC			
	Demand Users only need to refer to their contract – easy to use.			

	Demand Users not made to comply with the Grid code where they didn't previously.			
Following circulation of the above from the Proposer the option below was suggested as an option by a Workgroup member				
Technical requirements in Grid Code, commercial facilitation in CUSC	Fully transparent with a number of public consultations for both the Grid Code and CUSC changes; which can be proposed (and owned) by Users, Citizen's Advice, any Materially Affected Party (plus groups representing consumers, trade associations etc., can be designated a Materially Affected Party). Parties do not need to comply with all the Grid Code or CUSC obligations, just those relevant to connection and Demand Response (which means a level playing field for all parties).	[XYZ]	Open Governance / CACoP principles – would follow Grid Code and CUSC process timescales (approximately 6 months, although it can be much quicker, if needed). Other changes will be progressing at the same time though. Ofgem approval of all material changes to the technical or commercial arrangements.	Commerciality – would go in contract (as an Exhibit to the CUSC) be applicable to parties and refer parties to the Grid Code for technical requirements including compliance. This has been done for over 15 years in GB for similar matters and is a proven and robust approach. It is envisaged that reciprocal arrangements would be required in the D Code. Putting it another way the commercial contract (in the CUSC) would set out the services required, a condition of the contract would then specify the technical and compliance requirements required of the Grid Code with similar arrangements in for the D Code.

Annex 2 Draft legal text comments from Workgroup Consultation

This Annex has been uploaded separately and can be located on the website with this consultation document. **Please note that this Annex forms part of a workgroup consultation response and is not the final legal text.**

Annex 3 Terms of Reference

Workgroup Terms of Reference and Membership

TERMS OF REFERENCE FOR GC0104 WORKGROUP

EU Connection Codes GB Implementation – Demand Connection Code

Responsibilities

1. The Workgroup is responsible for assisting the Grid Code Review Panel in the evaluation of Grid Code Modification Proposal **GC0104, EU Connection Codes GB Implementation – Demand Connection Code** tabled by National Grid at the Grid Code Review Panel meeting on 16 August 2017.
2. The proposal must be evaluated to consider whether it better facilitates achievement of the Grid Code Objectives. These can be summarised as follows:
 - (i) *To permit the development, maintenance and operation of an efficient, coordinated and economical system for the transmission of electricity;*
 - (ii) *To facilitate competition in the generation and supply of electricity (and without limiting the foregoing, to facilitate the national electricity transmission system being made available to persons authorised to supply or generate electricity on terms which neither prevent nor restrict competition in the supply or generation of electricity);*
 - (iii) *Subject to sub-paragraphs (i) and (ii), to promote the security and efficiency of the electricity generation, transmission and distribution systems in the national; and*
 - (iv) *To efficiently discharge the obligations imposed upon the licensee by this license and to comply with the Electricity Regulation and any relevant legally binding decisions of the European Commission and/or the Agency. In conducting its business, the Workgroup will at all times endeavour to operate in a manner that is consistent with the Code Administration Code of Practice principles.*

Scope

3. The Workgroup must consider the issues raised by the Modification Proposal and consider if the proposal identified better facilitates achievement of the Grid Code Objectives.
4. In addition to the overriding requirement of point 3 above, the Workgroup shall consider and report on the following specific issues:
 - a) *Implementation;*
 - b) *Review draft legal text should it have been provided. If legal text is not submitted within the Grid Code Modification Proposal the Workgroup should be instructed to assist in the developing of the legal text; and*
 - c) *Consider whether any further Industry experts or stakeholders should be invited to participate within the Workgroup to ensure that all potentially affected stakeholders have the opportunity to be represented in the Workgroup.*

- d) Technical requirements for new* Transmission-connected Demand Facilities; Transmission-connected Distribution Facilities and Distribution Systems.
- e) Technical requirements for Demand Units used by a Demand Facility or a Closed Distribution System to provide Demand Response Services to System Operators.
 - 'New' is defined as not being connected to the system at the time that the code enters into force and not having concluded a final and binding contract for the purchase of main plant items by two years after entry into force.
- f) *The scope and applicability of the EU requirements under DCC, specifically articles are 12-47*
- g) *DSR impact*

Distribution Code impact

- a) *Scope and applicability of EU requirements under Demand Connection Code.*
5. As per Grid Code GR20.8 (a) and (b) the Workgroup should seek clarification and guidance from the Grid Code Review Panel when appropriate and required.
 6. The Workgroup is responsible for the formulation and evaluation of any Workgroup Alternative Grid Code Modifications arising from Group discussions which would, as compared with the Modification Proposal or the current version of the Grid Code, better facilitate achieving the Grid Code Objectives in relation to the issue or defect identified.
 7. The Workgroup should become conversant with the definition of Workgroup Alternative Grid Code Modification which appears in the Governance Rules of the Grid Code. The definition entitles the Group and/or an individual member of the Workgroup to put forward a Workgroup Alternative Code Modification proposal if the member(s) genuinely believes the alternative proposal compared with the Modification Proposal or the current version of the Grid Code better facilitates the Grid Code objectives. The extent of the support for the Modification Proposal or any Workgroup Alternative Modification (WACM) proposal arising from the Workgroup's discussions should be clearly described in the final Workgroup Report to the Grid Code Review Panel.
 8. Workgroup members should be mindful of efficiency and propose the fewest number of WACM proposals as possible. All new alternative proposals need to be proposed using the Alternative request Proposal form ensuring a reliable source of information for the Workgroup, Panel, Industry participants and the Authority.
 9. All WACM proposals should include the Proposer(s)'s details within the final Workgroup report, for the avoidance of doubt this includes WACM proposals which are proposed by the entire Workgroup or subset of members.
 10. There is an option for the Workgroup to undertake a period of Consultation in accordance with Grid Code GR. 20.11, if defined within the timetable agreed by the Grid Code Panel. Should the Workgroup determine that they see the benefit in a Workgroup Consultation being issued they can recommend this to the Grid Code Review Panel to consider.
 11. Following the Consultation period the Workgroup is required to consider all responses including any Workgroup Consultation Alternative Requests. In undertaking an assessment of any Workgroup Consultation Alternative Request, the Workgroup should consider whether it better facilitates the Grid Code Objectives than the current version of the Grid Code.

12. As appropriate, the Workgroup will be required to undertake any further analysis and update the appropriate sections of the original Modification Proposal and/or WACM proposals (Workgroup members cannot amend the original text submitted by the Proposer of the modification) All responses including any Workgroup Consultation Alternative Requests shall be included within the final report including a summary of the Workgroup's deliberations and conclusions. The report should make it clear where and why the Workgroup chairman has exercised their right under the Grid Code to progress a Workgroup Consultation Alternative Request or a WACM proposal against the majority views of Workgroup members. It should also be explicitly stated where, under these circumstances, the Workgroup chairman is employed by the same organisation who submitted the Workgroup Consultation Alternative Request.
13. The Workgroup is to submit its final report to the Modifications Panel Secretary on 18 April 2018 for circulation to Panel Members. The final report conclusions will be presented to the Grid Code Review Panel meeting on 26 April 2018.

Membership

It is recommended that the Workgroup has the following members:

Role	Name	Representing (User nominated)
Chair	Chrissie Brown	
Technical Secretary	Naomi Davies	
National Grid Representative*	Rachel Woodbridge-Stocks	NGET
	Anthony Johnson	NGET
Authority Representative		
Workgroup Member*	Mike Kay	Electricity North West
Workgroup Member	Timothy Moore	UK Power Networks
Workgroup Member*	Garth Graham	SSE
Workgroup Member*	Graeme Vincent	SP Energy Networks
Workgroup Member*	Isaac Gutierrez	Scottish Power Renewables
Workgroup Member*	Alan Creighton	Northern Powergrid
Workgroup Member*	Alastair Frew	Scottish Power Generation Ltd
Workgroup Member*	Tim Ellingham	RWE

14. A (*) Workgroup must comprise at least 5 members (who may be Panel Members). The roles identified with an asterisk(*) in the table above contribute toward the required quorum, determined in accordance with paragraph 15 below.
15. The Grid Code Review Panel must agree a number that will be quorum for each Workgroup meeting. The agreed figure for GC0104 is that at least 5 Workgroup members must participate in a meeting for quorum to be met.
16. A vote is to take place by all eligible Workgroup members on the Modification Proposal and each WACM proposal and Workgroup Consultation Alternative Request based on their assessment of the Proposal(s) against the Grid Code objectives when compared against the current Grid Code baseline.
- Do you support the Original or any of the alternative Proposals?
 - Which of the Proposals best facilitates the Grid Code Objectives?

The Workgroup chairman shall not have a vote, casting or otherwise.

The results from the vote and the reasons for such voting shall be recorded in the Workgroup report in as much detail as practicable.

17. It is expected that Workgroup members would only abstain from voting under limited circumstances, for example where a member feels that a proposal has been insufficiently developed. Where a member has such concerns, they should raise these with the Workgroup chairman at the earliest possible opportunity and certainly before the Workgroup vote takes place. Where abstention occurs, the reason should be recorded in the Workgroup report.
18. Workgroup members or their appointed alternate are required to attend a minimum of 50% of the Workgroup meetings to be eligible to participate in the Workgroup vote.
19. The Technical Secretary shall keep an Attendance Record for the Workgroup meetings and circulate the Attendance Record with the Action Notes after each meeting. This will be attached to the final Workgroup report.
20. The Workgroup membership can be amended from time to time by the Grid Code Review Panel and the Chairman of the Workgroup.

Appendix 1 – Indicative Workgroup Timetable

The following timetable is indicative for GC0104:

Date	Meeting
Workgroup Meeting 1	6 September 2017
Workgroup Meeting 2	6 December
Workgroup Meeting 3	23 January 2018
Workgroup Meeting 4	22 February 2018
Workgroup Consultation issued/closes	8 March/29 March 2018
Workgroup meeting 5 & 6	April 2018
Workgroup Report presented to Panel (submission/presented)	18 April 2018

Post Workgroup modification process:

Date	Meeting
Code Administration Consultation Report issued to the Industry (opens/closes)	16 May 2018/7 June 2018
Draft Final Modification Report presented to Industry and Panel (issued/presented)	8 June/14 June 2018
Modification Panel Recommendation vote	14 June 2018
Final Modification Report issued the Authority	25 June 2018
Authority decision due (25WDs)	30 July 2018
Decision implemented in Grid Code (10WDs)	14 August 2018

Annex 4 DCC Code Mapping

This Annex has been uploaded separately and is located in the Panel papers as GC0104 Annex 5.

Annex 5 Workgroup Consultation responses

Grid Code Workgroup Consultation Response Proforma

GC0104 EU Connection Codes GB Implementation – Demand Connection Code

Industry parties are invited to respond to this consultation expressing their views and supplying the rationale for those views, particularly in respect of any specific questions detailed below.

Please send your responses by **5pm** on **29 March 2018** to grid.code@nationalgrid.com. Please note that any responses received after the deadline or sent to a different email address may not receive due consideration by the Workgroup.

Any queries on the content of the consultation should be addressed to Chrissie Brown at Christine.brown1@nationalgrid.com

Respondent:	<i>Rick Parfett, rick.parfett@theade.co.uk</i>
Company Name:	<i>The Association for Decentralised Energy (ADE)</i>
<p>Please express your views regarding the Workgroup Consultation, including rationale.</p> <p>(Please include any issues, suggestions or queries)</p>	<p><i>For reference, the Grid Code objectives are:</i></p> <ol style="list-style-type: none"> i. To permit the development, maintenance and operation of an efficient, coordinated and economical system for the transmission of electricity ii. To facilitate competition in the generation and supply of electricity (and without limiting the foregoing, to facilitate the national electricity transmission system being made available to persons authorised to supply or generate electricity on terms which neither prevent nor restrict competition in the supply or generation of electricity) iii. Subject to sub-paragraphs (i) and (ii), to promote the security and efficiency of the electricity generation, transmission and distribution systems in the national electricity transmission system operator area taken as a whole iv. To efficiently discharge the obligations imposed upon the licensee by this license and to comply with the Electricity Regulation and any relevant legally binding decisions of the European Commission and/or the Agency; and v. To promote efficiency in the implementation and administration of the Grid Code arrangements. <p><i>The Distribution Code objectives are:</i></p> <ol style="list-style-type: none"> i. Permit the development, maintenance, and operation of an efficient, coordinated and economical System for the distribution of electricity. ii. Facilitate competition in the generation and supply of electricity. iii. Efficiently discharge the obligations imposed upon DNOs by the Distribution Licence and comply with the

	<p>Regulation (where Regulation has the meaning defined in the Distribution Licence) and any relevant legally binding decision of the European Commission and/or Agency for the Co-operation of Energy Regulators.</p> <p>iv. Promote efficiency in the implementation and administration of the Distribution Code.</p>
--	---

Standard Workgroup Consultation questions

Q	Question	Response
1	Do you believe that GC0104 Original proposal, or any potential alternatives for change that you wish to suggest, better facilitates the Grid Code Objectives?	<p>The ADE believes that the GC0104 Original proposal better facilitates Grid Code objective four by ensuring GB compliance with EU legislation.</p> <p>As part of the third Energy Package, the proposal has the potential to better facilitate Grid Code objectives one, two and three. In its current form, however, the proposal risks creating unnecessary barriers to entry and certification requirements for DSR providers, with consequent impacts upon competition and efficiency.</p> <p>These issues are outlined in our response to Question 10.</p>
2	Do you support the proposed implementation approach?	The ADE supports the implementation approach, noting the need for implementation by 7 September 2018, if the issues outlined are resolved.
3	Do you have any other comments?	The ADE has no comment.
4	Do you wish to raise a WG Consultation Alternative Request for the Workgroup to consider?	<p><i>If yes, please complete a WG Consultation Alternative Request form, available on National Grid's website,</i></p> <p>https://www.nationalgrid.com/uk/electricity/codes/grid-code and return to the Grid Code inbox at grid.code@nationalgrid.com</p>

Specific GC0104 questions

Q	Question	Response
5	Do you agree that DNOs should only implement the Demand Response requirements relating to Demand Response Active Power Control and Demand Response Reactive Power Control, recognizing that the	The ADE has no comment.

	other DSR services in Article 27 are services for the Transmission System Operator?	
6	Are the rights and obligations of aggregators appropriately allowed for in the drafting of ECC and DPC9? If not, what additional provisions would you suggest?	The ADE has no comment.
7	Do you have any comments on the approach taken with the Installation Document pro-forma proposed for Demand Response services contracted to DNOs? Do you agree that there is no distinction necessary here for HV or LV customers?	The ADE has no comment.
8	Do you have any views on how to tailor the compliance process, and documentation, to accommodate both individual Demand Response Service Providers and those Demand Response Service Providers who are aggregators?	The ADE has no comment.
9	Can you see any issues with treating GSPs and EU GSP's in the way set out in the Glossary and Definitions and European Connection Conditions of the solution?	The ADE has no comment.
10	Do you agree that the DRSC reflects the requirements of DCC and provides sufficient information for Demand Response Providers. If not, please state why do not believe this to be the case and what you believe would provide a better alternative.	<p>The ADE welcomes most of the contents of the DRSC. There are currently, however, several sections which contain requirements that are either too broadly defined or should only apply to providers of certain Demand Response services. These are:</p> <ol style="list-style-type: none"> 1. DRSC.5.1 requires that any plant or apparatus that provides Demand Response services must tolerate frequencies above 51.5 Hz for 15 minutes and below 47.5 Hz for 20 seconds, as well as a Rate of Change of Frequency of 1 Hz/s. Similar requirements exist for voltage tolerances. <p>While these requirements are reasonable for new transmission-connected customer sites, extending this requirement to all sites that provide demand response is unreasonable and likely to strongly deter the provision of</p>

		<p>demand response. DSR aggregators will be unable to prove that all of a customer's plant can meet the above requirements; it would be extremely onerous to collect certification for every piece of equipment on the customer site (certificates which may not exist in all cases) and testing would be extremely expensive and disruptive. Testing an entire customer site would require an aggregator to take the whole site 'off grid' and supply it all from a generator that is then modulated to the required extremes of frequency and voltage. The requirements are therefore disproportionate and impossible to implement on these sites. In addition, it is unclear how these requirements could be proven, as is required under DRSC.11.6.1.1</p> <ol style="list-style-type: none">2. We welcome the acknowledgement under DRSC.9.1 that operational metering requirements will vary depending upon the type of Ancillary Service. We would like to see explicit recognition, however, that, lower resolution metering is acceptable in certain cases, so long as it is allowed by the service. This is because units providing DSR services do not necessarily have standard metering equipment, in the same way that generation does, and such equipment would be prohibitively costly to install on every asset.3. DRSC.11.4.2.3(a) contains a requirement to provide "<i>all</i> documentation and certificates" (my italics) to evidence compliance. This is too broad a piece of drafting and is therefore impossible to satisfy; the word 'all' should be replaced by the word 'relevant'.4. DRSC.11.4.2 and 11.5 allow NGET to request extra information and testing from Providers in a broad range of scenarios. While this is completely legitimate in certain scenarios, the current drafting seems too broad. Fulfilling extra tests is costly and burdensome for a DSR provider in a way that it is not for most generation because it involves customers altering or interrupting production schedules, leading to potential loss of revenue. While this is sometimes
--	--	--

		<p>unavoidable, the costs imposed mean that a limited list of specific scenarios where NGET can request extra information or testing should be included in the drafting.</p> <ol style="list-style-type: none">5. DRSC.11.4.2.3(c) and (d) require DSR providers to submit “steady state and dynamic models of plant and apparatus” and “study results showing the expected steady state and dynamic performance”. While this requirement is reasonable for reactive power services and dynamic frequency response, it seems unnecessary for reserve services and static frequency response.6. DRSC.11.8.1 requires that Demand Units providing Demand Response Very Fast Active Power Control supply a model to NGET to demonstrate technical capability. While this requirement is suitable for very fast dynamic frequency response, it is likely that test results will be sufficient to demonstrate technical capability for very fast static frequency response.7. We welcome the recognition in DRSC.6.1 that demand units that provide DSR services to the Grid through an aggregated pool (rather than individually) should submit information at an aggregated level, via the aggregator. This is very important, because each unit may only make a partial contribution to the overall service so being able to define, for example, the frequency range operated within at an individual level would be impossible; what matters is the aggregate outcome. <p>We would appreciate clarification, however, on the subclause highlighted in bold: “For the avoidance of doubt, these requirements shall apply either individually or where it is not part of a Non-Embedded Customers System, collectively as part of a Demand aggregation scheme through a Demand Response Provider”. It is important that these subclause is not interpreted as obliging certain sites to declare information and fulfil requirements on a standalone, rather than aggregate, basis. We would therefore</p>
--	--	--

		appreciate a clear statement that, for any aggregated pool of sites, the relevant range of frequency is to be delivered at an aggregate level.
11	If you do not believe the proposal sufficiently discharges DCC obligations, can you please provide examples where this is the case?	The ADE has no comment.
12	<p>Consultation question specifically for Transmission Licensees</p> <p>As a Transmission Licensee, are there any aspects of this consultation you do not agree with from a Transmission Licensees perspective? In particular do you have any comments with regard to DCC Articles 28 and 29 in particular Article 29(2)(d) where there is a requirement for the relevant TSO to consult with TSO's in the Synchronous Area.</p>	The ADE has no comment.
	Legal text comments	
	<i>If you believe there are issues in the legal text, can you please bring these to our attention by using the space provided on the response proforma. These will then be discussed at the GC0104 legal text session planned following the closure of this Consultation.</i>	The ADE has no comment.

Grid Code Workgroup Consultation Response Proforma

GC0104 EU Connection Codes GB Implementation – Demand Connection Code

Industry parties are invited to respond to this consultation expressing their views and supplying the rationale for those views, particularly in respect of any specific questions detailed below.

Please send your responses by **5pm** on **29 March 2018** to grid.code@nationalgrid.com. Please note that any responses received after the deadline or sent to a different email address may not receive due consideration by the Workgroup.

Any queries on the content of the consultation should be addressed to Chrissie Brown at Christine.brown1@nationalgrid.com

Respondent:	<i>David Spillett - 02077065124</i>
Company Name:	<i>Energy Networks Association</i>
<p>Please express your views regarding the Workgroup Consultation, including rationale.</p> <p>(Please include any issues, suggestions or queries)</p>	<p><i>For reference, the Grid Code objectives are:</i></p> <ul style="list-style-type: none"> i. To permit the development, maintenance and operation of an efficient, coordinated and economical system for the transmission of electricity ii. To facilitate competition in the generation and supply of electricity (and without limiting the foregoing, to facilitate the national electricity transmission system being made available to persons authorised to supply or generate electricity on terms which neither prevent nor restrict competition in the supply or generation of electricity) iii. Subject to sub-paragraphs (i) and (ii), to promote the security and efficiency of the electricity generation, transmission and distribution systems in the national electricity transmission system operator area taken as a whole iv. To efficiently discharge the obligations imposed upon the licensee by this license and to comply with the Electricity Regulation and any relevant legally binding decisions of the European Commission and/or the Agency; and v. To promote efficiency in the implementation and administration of the Grid Code arrangements <p><i>The Distribution Code objectives are:</i></p> <ul style="list-style-type: none"> i. Permit the development, maintenance, and operation of an efficient, coordinated and economical System for the distribution of electricity. ii. Facilitate competition in the generation and supply of electricity. iii. Efficiently discharge the obligations imposed upon DNOs by the Distribution Licence and comply with the

	<p>Regulation (where Regulation has the meaning defined in the Distribution Licence) and any relevant legally binding decision of the European Commission and/or Agency for the Co-operation of Energy Regulators.</p> <p>iv. Promote efficiency in the implementation and administration of the Distribution Code.</p>
--	---

Standard Workgroup Consultation questions

Q	Question	Response
1	Do you believe that GC0104 Original proposal, or any potential alternatives for change that you wish to suggest, better facilitates the Grid Code Objectives?	Yes
2	Do you support the proposed implementation approach?	Yes
3	Do you have any other comments?	Demand side response services are in their infancy. The drafting of requirements into GB codes must do no more than reflect the absolute basics of the DCC, leaving as much scope as possible for technical and commercial innovation in delivering such services. The consultation drafting of the Grid and Distribution Code appears to achieve this balance, and it would be wrong to press for more detail to be included at this time.
4	Do you wish to raise a WG Consultation Alternative Request for the Workgroup to consider?	No

Specific GC0104 questions

Q	Question	Response
5	Do you agree that DNOs should only implement the Demand Response requirements relating to Demand Response Active Power Control and Demand Response Reactive Power Control, recognizing that the other DSR services in Article 27 are services for the Transmission System Operator?	Yes.
6	Are the rights and obligations of aggregators appropriately	Given the immaturity of such services, it is in

	allowed for in the drafting of ECC and DPC9? If not, what additional provisions would you suggest?	appropriate to consider creating more detailed requirements at this time, which might stifle appropriate commercial development of services.
7	Do you have any comments on the approach taken with the Installation Document pro-forma proposed for Demand Response services contracted to DNOs? Do you agree that there is no distinction necessary here for HV or LV customers?	No additional comments and we agree that the installation document and DRUD can be combined.
8	Do you have any views on how to tailor the compliance process, and documentation, to accommodate both individual Demand Response Service Providers and those Demand Response Service Providers who are aggregators?	Not at this time.
9	Can you see any issues with treating GSPs and EU GSP's in the way set out in the Glossary and Definitions and European Connection Conditions of the solution?	Yes. There is insufficient clarity about when a GSP might become an EU GSP, ie what sort of modification to the site will trigger the change of status. There are some suggested changes to legal text below
10	Do you agree that the DRSC reflects the requirements of DCC and provides sufficient information for Demand Response Providers. If not, please state why do not believe this to be the case and what you believe would provide a better alternative.	Yes
11	If you do not believe the proposal sufficiently discharges DCC obligations, can you please provide examples where this is the case?	The proposal is adequate for compliance with the DCC.
12	Consultation question specifically for Transmission Licensees As a Transmission Licensee, are there any aspects of this consultation you do not agree with from a Transmission Licensees perspective? In particular do you have any comments with regard to DCC Articles 28 and 29 in particular Article 29(2)(d) where there is a requirement for the relevant TSO	N/A

	to consult with TSO's in the Synchronous Area.	
	Legal text comments	
	<i>If you believe there are issues in the legal text, can you please bring these to our attention by using the space provided on the response proforma. These will then be discussed at the GC0104 legal text session planned following the closure of this Consultation.</i>	See below:

Glossary and Definitions

The definition of Main Plant and Equipment can be clarified to make it clear that an EU GSP has this status based on a substantial investment, not just on, for example, the addition of a new circuit breaker.

EU Code User

....

- (h) A Network Operator whose entire distribution System was first connected to the ~~Transmisison~~Transmission System on or after 7 September 2019 or who had placed Purchase Contracts for its Main Plant and Apparatus in respect of its ~~total~~entire distribution System on or after 7 September 2018. In this case, a Network Operator's entire system would only have EU Grid Supply Points at each Connection Point with the National Electricity Transmission System.

Main Plant and Equipment

...

In respect of a Network Operator's equipment or a Non-Embedded Customer's equipment, is ~~one the majority~~ of the principale items of ~~Plant or~~ Apparatus required at each EU Grid Supply Point to facilitate the import or export of Active Power or Reactive Power to a Network Operator's or Non Embedded Customer's System.

ECC

In ECC 6.4.5.1 it is necessary to consider the implications of wider reactive power limits (ie requiring the capability to support more MVAR) rather than narrower.

ECC.6.4.5.1 At each **EU Grid Supply Point**, **Non-Embedded Customers** and **Network Operators** who are **EU Code Users** shall ensure their **Systems** are capable of steady state operation within the **Reactive Power** limits as specified in ECC.6.4.5.1(a) and ECC.6.4.5.1(b). Where **NGET** requires a **Reactive Power** range which is ~~narrower~~ broader than the limits defined in ECC.6.4.5.1(a) and ECC.6.4.5.1(b), this will be agreed as a reasonable requirement through joint assessment between the relevant **EU Code User** and **NGET** and justified in accordance with the requirements of ECC.6.4.5.1(c), (d), (e) and (f). For the avoidance of doubt, the requirements of ECC.6.4.5 do not apply to **Network Operators** who are also **GB Code Users** and own or operate one or more **EU Grid Supply Points** .

The text in Appendix E5 has misinterpreted the intent of the DCC in relation to directional blocking of LFDD. It is also unlikely that there would be a LFDD relay at a GSP.

ECC.A.5.1.1 The **Low Frequency Relays** to be used shall have a setting range of 47.0 to 50Hz and be suitable for operation from a nominal AC input of 63.5, 110 or 240V. The following parameters specify the requirements of approved **Low Frequency Relays**:

- (a) **Frequency** settings: 47-50Hz in steps of 0.05Hz or better, preferably 0.01Hz;
- (b) Operating time: Relay operating time shall not be more than 150 ms;
- (c) Voltage lock-out: Selectable within a range of 55 to 90% of nominal voltage;
- (d) Direction Tripping interlock for forward or reverse power flow capable of being set in either position or off
- ~~(ee)~~ Facility stages: One or two stages of **Frequency** operation;
- ~~(fe)~~ Output contacts: Two output contacts per stage to be capable of repetitively making and breaking for 1000 operations:
- ~~(gf)~~ Accuracy: 0.01 Hz maximum error under reference environmental and system voltage conditions.
0.05 Hz maximum error at 8% of total harmonic distortion **Electromagnetic Compatibility Level**.
- (h) Indications Provide the direction of **Active Power** flow at the point of de-energisation.

In the case of **Network Operators** who are also **GB Code User's**, the above requirements ~~would~~ only apply to ~~the a relay~~ (if any) installed at the **EU Grid Supply Point**. **Network Operators** who are also **GB Code Users** should continue to satisfy the requirements for low frequency relays as specified in the **CC's** as applicable to their **Total System**.

Grid Code Workgroup Consultation Response Proforma

GC0104 EU Connection Codes GB Implementation – Demand Connection Code

Industry parties are invited to respond to this consultation expressing their views and supplying the rationale for those views, particularly in respect of any specific questions detailed below.

Please send your responses by **5pm** on **29 March 2018** to grid.code@nationalgrid.com. Please note that any responses received after the deadline or sent to a different email address may not receive due consideration by the Workgroup.

Any queries on the content of the consultation should be addressed to Chrissie Brown at Christine.brown1@nationalgrid.com

Respondent:	<i>Please insert your name and contact details (phone number or email address)</i>
Company Name:	<i>Please insert Company Name</i>
<p>Please express your views regarding the Workgroup Consultation, including rationale.</p> <p>(Please include any issues, suggestions or queries)</p>	<p><i>For reference, the Grid Code objectives are:</i></p> <ol style="list-style-type: none"> i. To permit the development, maintenance and operation of an efficient, coordinated and economical system for the transmission of electricity ii. To facilitate competition in the generation and supply of electricity (and without limiting the foregoing, to facilitate the national electricity transmission system being made available to persons authorised to supply or generate electricity on terms which neither prevent nor restrict competition in the supply or generation of electricity) iii. Subject to sub-paragraphs (i) and (ii), to promote the security and efficiency of the electricity generation, transmission and distribution systems in the national electricity transmission system operator area taken as a whole iv. To efficiently discharge the obligations imposed upon the licensee by this license and to comply with the Electricity Regulation and any relevant legally binding decisions of the European Commission and/or the Agency; and v. To promote efficiency in the implementation and administration of the Grid Code arrangements. <p><i>The Distribution Code objectives are:</i></p> <ol style="list-style-type: none"> i. Permit the development, maintenance, and operation of an efficient, coordinated and economical System for the distribution of electricity. ii. Facilitate competition in the generation and supply of electricity. iii. Efficiently discharge the obligations imposed upon DNOs

	<p>by the Distribution Licence and comply with the Regulation (where Regulation has the meaning defined in the Distribution Licence) and any relevant legally binding decision of the European Commission and/or Agency for the Co-operation of Energy Regulators.</p> <p>iv. Promote efficiency in the implementation and administration of the Distribution Code.</p>
--	---

Standard Workgroup Consultation questions

Q	Question	Response
1	Do you believe that GC0104 Original proposal, or any potential alternatives for change that you wish to suggest, better facilitates the Grid Code Objectives?	Yes
2	Do you support the proposed implementation approach?	Yes
3	Do you have any other comments?	See responses to the specific questions
4	Do you wish to raise a WG Consultation Alternative Request for the Workgroup to consider?	<p><i>If yes, please complete a WG Consultation Alternative Request form, available on National Grid's website,</i></p> <p>https://www.nationalgrid.com/uk/electricity/codes/grid-code and return to the Grid Code inbox at grid.code@nationalgrid.com</p>

Specific GC0104 questions

Q	Question	Response
5	Do you agree that DNOs should only implement the Demand Response requirements relating to Demand Response Active Power Control and Demand Response Reactive Power Control, recognizing that the other DSR services in Article 27 are services for the Transmission System Operator?	No, agreed that DNOs do not manage frequency (b)(i) demand response system frequency control should be excluded. There is a presumption that very fast active power control is solely to manage frequency, is that definitely the case or are there other potential ? Also under a whole system approach couldn't DNOs/ DSOs procure services for transmission constraint management. These proposals should not prevent such developments if they are in the best interests of consumers.
6	Are the rights and obligations of aggregators appropriately allowed for in the drafting of ECC and DPC9? If not, what	The drafting appears satisfactory.

	additional provisions would you suggest?	
7	Do you have any comments on the approach taken with the Installation Document pro-forma proposed for Demand Response services contracted to DNOs? Do you agree that there is no distinction necessary here for HV or LV customers?	Yes, we do not agree with the proposed approach. The pro-forma document seems to request information that is not specified in Article 32(6). Implementation should focus on doing the minimum to ensure compliance not adding additional regulatory burdens.
8	Do you have any views on how to tailor the compliance process, and documentation, to accommodate both individual Demand Response Service Providers and those Demand Response Service Providers who are aggregators?	We should avoid embedding too much into codes at this stage as these services are evolving and further codification should wait until best practice has emerged.
9	Can you see any issues with treating GSPs and EU GSP's in the way set out in the Glossary and Definitions and European Connection Conditions of the solution?	None that we have identified
10	Do you agree that the DRSC reflects the requirements of DCC and provides sufficient information for Demand Response Providers. If not, please state why do not believe this to be the case and what you believe would provide a better alternative.	The drafting appears to reflect the provisions in the DCC. Should the detail referred to in APPENDIX II – DRSC.A.2 be included in the Grid Code or left to the contractual agreements. The information specified appears in excess of that required in the DCC
11	If you do not believe the proposal sufficiently discharges DCC obligations, can you please provide examples where this is the case?	It appears to include into the Grid Code the DCC requirements
12	<p>Consultation question specifically for Transmission Licensees</p> <p>As a Transmission Licensee, are there any aspects of this consultation you do not agree with from a Transmission Licensees perspective? In particular do you have any comments with regard to DCC Articles 28 and 29 in particular Article 29(2)(d) where there is a requirement for the relevant TSO to consult with TSO's in the Synchronous Area.</p>	

	Legal text comments	
	<i>If you believe there are issues in the legal text, can you please bring these to our attention by using the space provided on the response proforma. These will then be discussed at the GC0104 legal text session planned following the closure of this Consultation.</i>	Legal text not reviewed.

Grid Code Workgroup Consultation Response Proforma

GC0104 EU Connection Codes GB Implementation – Demand Connection Code

Industry parties are invited to respond to this consultation expressing their views and supplying the rationale for those views, particularly in respect of any specific questions detailed below.

Please send your responses by **5pm** on **29 March 2018** to grid.code@nationalgrid.com. Please note that any responses received after the deadline or sent to a different email address may not receive due consideration by the Workgroup.

Any queries on the content of the consultation should be addressed to Chrissie Brown at Christine.brown1@nationalgrid.com

Respondent:	<i>Please insert your name and contact details (phone number or email address)</i> <u>Saskia Barker saskia.barker@flexitricity.com</u>
Company Name:	<i>Flexitricity Ltd</i>
Please express your views regarding the Workgroup Consultation, including rationale. (Please include any issues, suggestions or queries)	<p><i>For reference, the Grid Code objectives are:</i></p> <ol style="list-style-type: none"> i. To permit the development, maintenance and operation of an efficient, coordinated and economical system for the transmission of electricity ii. To facilitate competition in the generation and supply of electricity (and without limiting the foregoing, to facilitate the national electricity transmission system being made available to persons authorised to supply or generate electricity on terms which neither prevent nor restrict competition in the supply or generation of electricity) iii. Subject to sub-paragraphs (i) and (ii), to promote the security and efficiency of the electricity generation, transmission and distribution systems in the national electricity transmission system operator area taken as a whole iv. To efficiently discharge the obligations imposed upon the licensee by this license and to comply with the Electricity Regulation and any relevant legally binding decisions of the European Commission and/or the Agency; and v. To promote efficiency in the implementation and administration of the Grid Code arrangements. <p><i>The Distribution Code objectives are:</i></p> <ol style="list-style-type: none"> i. Permit the development, maintenance, and operation of an efficient, coordinated and economical System for the distribution of electricity. ii. Facilitate competition in the generation and supply of electricity. iii. Efficiently discharge the obligations imposed upon DNOs

	<p>by the Distribution Licence and comply with the Regulation (where Regulation has the meaning defined in the Distribution Licence) and any relevant legally binding decision of the European Commission and/or Agency for the Co-operation of Energy Regulators.</p> <p>iv. Promote efficiency in the implementation and administration of the Distribution Code.</p>
--	---

Standard Workgroup Consultation questions

Q	Question	Response
1	Do you believe that GC0104 Original proposal, or any potential alternatives for change that you wish to suggest, better facilitates the Grid Code Objectives?	The original proposal better facilitates Grid Code Objective (iv) because it discharges the TSOs obligations under the DCC. There are issues with the way the solution has been written that make the process of providing demand side response more confusing, and thus it is not in line with Grid Code Objective (v). But overall the proposal is better than the baseline because the alternative is non-compliance with EU legislation.
2	Do you support the proposed implementation approach?	Yes
3	Do you have any other comments?	<p>If the proposal is implemented as suggested, in that the SCTs for DSR services are only updated to point users to the new DRSC section of the Grid Code, it will create a lot of confusion in the market. National Grid and any DNOs procuring DSR services must write guidance documents to explain what the new obligations on DSR providers are. Especially since the legal text is vague in many areas, for example in asking for 'All documentation and certificates' from a DSR provider. It is unclear what documentation the TSO will require and what use it will be to the TSO. As there are many types of demand that can provide DSR services, it makes sense to draft that legal text as such, but the TSO must work with providers to understand what kind of documentation, modelling, etc is appropriate, useful to the TSO and practically available to providers.</p> <p>While National Grid have made a strong, and appreciated effort to attempt to demystify what the obligations on DSR providers will be, the decision to put the changes in the grid code rather than in the STCs for demand response mean that the changes will ultimately be confusing to DSR participants, especially those customers not going through an aggregator. This seems counter to the principals set</p>

		out in the entso-e guidelines which are supposed to remove barriers to entry, rather than create them.
4	Do you wish to raise a WG Consultation Alternative Request for the Workgroup to consider?	No

Specific GC0104 questions

Q	Question	Response
5	Do you agree that DNOs should only implement the Demand Response requirements relating to Demand Response Active Power Control and Demand Response Reactive Power Control, recognizing that the other DSR services in Article 27 are services for the Transmission System Operator?	Yes.
6	Are the rights and obligations of aggregators appropriately allowed for in the drafting of ECC and DPC9? If not, what additional provisions would you suggest?	<p>The default response time specified in DPC9.3.3.3 is in the frequency response range, rather than active or reactive power DSR range. A default of something along the lines of 5-10 minutes would make more sense.</p> <p>The data specified in DPC9.4.1 being specified one month in advance is fine, but must be implemented correctly for aggregated groups. If new units are added to a group, this should not bar the rest of that group from operation for example.</p> <p>The references to other pieces of EU legislation (EU 2016/631 etc) in the definition of 'Manufacture's information' in DPC9 should be more explicit so that providers are not being made to wade through EU legislation. The paperwork required from providers should be described clearly by the DNO procuring the service in the service contract, rather than sending the provider needing to be versed in EU legislation.</p> <p>There is no mention of aggregators or aggregation in the ECC that I could see, so if there are any, they are difficult to find.</p>
7	Do you have any comments on the approach taken with the	There is no distinction necessary for HV and LV customers.

	<p>Installation Document pro-forma proposed for Demand Response services contracted to DNOs? Do you agree that there is no distinction necessary here for HV or LV customers?</p>	<p>Where is 'fully type tested' defined?</p> <p>The obligations in DSR3 are either excessively complex or poorly expressed. Who will be carrying out these tests for individual sites, how will it be verified?</p> <p>How much manufacturer involvement does ENA actually expect to have in this process? Will there be any incentive for manufacturers to participate, especially considering that DNO DSR is currently rare and made up mostly of short term contracts.</p>
8	<p>Do you have any views on how to tailor the compliance process, and documentation, to accommodate both individual Demand Response Service Providers and those Demand Response Service Providers who are aggregators?</p>	<p>The easiest way to do this is to have the compliance and documentation process be on a site by site or unit by unit basis, and then have a secondary process for assigning compliant, documented units or sites to aggregated groups. If the units are not tested and documented individually, the other units in an aggregated portfolio would be forced out of the market every time a new unit joins, or has a temporary outage.</p>
9	<p>Can you see any issues with treating GSPs and EU GSP's in the way set out in the Glossary and Definitions and European Connection Conditions of the solution?</p>	<p>No opinion</p>
10	<p>Do you agree that the DRSC reflects the requirements of DCC and provides sufficient information for Demand Response Providers. If not, please state why do not believe this to be the case and what you believe would provide a better alternative.</p>	<p>No, the DRSC does not provide sufficient information for Demand Response Providers.</p> <p>There is not enough detail in the DRSC for providers to know what the obligations on them will be, so there will need to be another document, on top of the DRSC, and the SCTs for the service to explain how the two relate to each other. This is obviously not ideal as it means providers will now have 3 sets of documentation they need to comply with, rather than the one they currently need to. This could be avoided if the obligations from the DRSC are transposed into the SCTs.</p>
11	<p>If you do not believe the proposal sufficiently discharges DCC obligations, can you please provide examples where this is the case?</p>	<p>N/A</p>
12	<p>Consultation question specifically for Transmission Licensees</p> <p>As a Transmission Licensee, are</p>	<p>N/A</p>

	<p>there any aspects of this consultation you do not agree with from a Transmission Licensees perspective? In particular do you have any comments with regard to DCC Articles 28 and 29 in particular Article 29(2)(d) where there is a requirement for the relevant TSO to consult with TSO's in the Synchronous Area.</p>	
	<p>Legal text comments</p>	<p>None</p>
	<p><i>If you believe there are issues in the legal text, can you please bring these to our attention by using the space provided on the response proforma. These will then be discussed at the GC0104 legal text session planned following the closure of this Consultation.</i></p>	<p>N/A</p>

Grid Code Workgroup Consultation Response Proforma

GC0104 EU Connection Codes GB Implementation – Demand Connection Code

Industry parties are invited to respond to this consultation expressing their views and supplying the rationale for those views, particularly in respect of any specific questions detailed below.

Please send your responses by **5pm** on **29 March 2018** to grid.code@nationalgrid.com. Please note that any responses received after the deadline or sent to a different email address may not receive due consideration by the Workgroup.

Any queries on the content of the consultation should be addressed to Chrissie Brown at Christine.brown1@nationalgrid.com

Respondent:	<i>Rachel Woodbridge-Stocks</i>
Company Name:	<i>National Grid</i>
<p>Please express your views regarding the Workgroup Consultation, including rationale.</p> <p>(Please include any issues, suggestions or queries)</p>	<p>We believe this Workgroup Consultation comes at a good point in the workgroup development of this modification to open up GC0104 to wider opinion and to help ratify the issues that have been discussed and resolved in the workgroup.</p> <p>A lot of work has gone into bringing in the wider views of stakeholders, who are often new to the Grid Code modification process, throughout this work and encouraging demand providers in particular to offer suggestions and provide feedback.</p> <p>The responses to this consultation will be used to help finalise the solution and implement the Demand Connection Code which it should be remembered is one of a suite of European Connection Codes which places technical requirements on parties connecting equipment to the system; these codes though do not attempt to address any commercial issues or frameworks.</p> <p><i>For reference, the Grid Code objectives are:</i></p> <ol style="list-style-type: none"> i. To permit the development, maintenance and operation of an efficient, coordinated and economical system for the transmission of electricity ii. To facilitate competition in the generation and supply of electricity (and without limiting the foregoing, to facilitate the national electricity transmission system being made available to persons authorised to supply or generate electricity on terms which neither prevent nor restrict competition in the supply or generation of electricity) iii. Subject to sub-paragraphs (i) and (ii), to promote the security and efficiency of the electricity generation, transmission and distribution systems in the national

	<p>electricity transmission system operator area taken as a whole</p> <p>iv. To efficiently discharge the obligations imposed upon the licensee by this license and to comply with the Electricity Regulation and any relevant legally binding decisions of the European Commission and/or the Agency; and</p> <p>v. To promote efficiency in the implementation and administration of the Grid Code arrangements.</p> <p><i>The Distribution Code objectives are:</i></p> <p>i. Permit the development, maintenance, and operation of an efficient, coordinated and economical System for the distribution of electricity.</p> <p>ii. Facilitate competition in the generation and supply of electricity.</p> <p>iii. Efficiently discharge the obligations imposed upon DNOs by the Distribution Licence and comply with the Regulation (where Regulation has the meaning defined in the Distribution Licence) and any relevant legally binding decision of the European Commission and/or Agency for the Co-operation of Energy Regulators.</p> <p>iv. Promote efficiency in the implementation and administration of the Distribution Code.</p>
--	---

Standard Workgroup Consultation questions

Q	Question	Response
1	Do you believe that GC0104 Original proposal, or any potential alternatives for change that you wish to suggest, better facilitates the Grid Code Objectives?	<p>We believe the Original proposal better facilitates the Grid Code Objectives.</p> <p>An assessment of the original proposal against the Grid Code objectives is as follows:</p> <p><i>i. To permit the development, maintenance and operation of an efficient, coordinated and economical system for the transmission of electricity</i></p> <p>Positive. By implementing DCC into the Grid Code in line with Ofgem's guidance to only make those changes necessary to GB frameworks (as can be found in their 2014 Decision Letter), the current framework requirements for operating the system efficiently have been maintained whilst incorporating the requirements necessary to harmonise with Europe in this area. This</p>

		<p>therefore facilitates the further development of a coordinated and efficient system in the growing area of demand side services.</p> <p><i>ii. To facilitate competition in the generation and supply of electricity (and without limiting the foregoing, to facilitate the national electricity transmission system being made available to persons authorised to supply or generate electricity on terms which neither prevent nor restrict competition in the supply or generation of electricity)</i></p> <p>Positive. By implementing the necessary changes required by DCC, competition will be extended and harmonised across demand and generation services.</p> <p><i>iii. Subject to sub-paragraphs (i) and (ii), to promote the security and efficiency of the electricity generation, transmission and distribution systems in the national electricity transmission system operator area taken as a whole</i></p> <p>Positive. By establishing harmonised requirements for demand side services and the security and efficiency of the system will be enhanced.</p> <p><i>iv. To efficiently discharge the obligations imposed upon the licensee by this license and to comply with the Electricity Regulation and any relevant legally binding decisions of the European Commission and/or the Agency; and</i></p> <p>Positive. This modification is required to implement elements of the European Connection Codes forming part of the suite of European Network Codes resulting from the EU 3rd Package legislation (EC 714/2009). The most efficient way of discharging these obligations is to adopt Ofgem’s approach of using existing processes to make only those changes necessary to GB frameworks.</p> <p><i>v. To promote efficiency in the implementation and administration of the Grid Code arrangements</i></p> <p>Neutral. No major impacts on the process of administering the Grid Code.</p>
--	--	--

2	Do you support the proposed implementation approach?	Yes
3	Do you have any other comments?	No
4	Do you wish to raise a WG Consultation Alternative Request for the Workgroup to consider?	<i>If yes, please complete a WG Consultation Alternative Request form, available on National Grid's website, https://www.nationalgrid.com/uk/electricity/codes/grid-code and return to the Grid Code inbox at grid.code@nationalgrid.com</i>

Specific GC0104 questions

Q	Question	Response
5	Do you agree that DNOs should only implement the Demand Response requirements relating to Demand Response Active Power Control and Demand Response Reactive Power Control, recognizing that the other DSR services in Article 27 are services for the Transmission System Operator?	Yes
6	Are the rights and obligations of aggregators appropriately allowed for in the drafting of ECC and DPC9? If not, what additional provisions would you suggest?	We believe they are.
7	Do you have any comments on the approach taken with the Installation Document pro-forma proposed for Demand Response services contracted to DNOs? Do you agree that there is no distinction necessary here for HV or LV customers?	We believe the requirements in the Installation Document and the Demand Response Unit Document are similar enough that they can be combined into one document. However, if an additional requirement is identified in the DRUD that isn't required in the ID it should be highlighted that this information isn't required from LV customers.
8	Do you have any views on how to tailor the compliance process, and documentation, to accommodate both individual Demand Response Service Providers and those Demand Response Service Providers who are aggregators?	We don't have views on this and welcome suggestions from stakeholders.

9	Can you see any issues with treating GSPs and EU GSP's in the way set out in the Glossary and Definitions and European Connection Conditions of the solution?	This was subject to extensive discussion late in the workgroup development process. The issues may hinge around interpretation of new/existing provisions in the particular case of substantial modification. However, a basic principle is that an existing GSP would only be considered as new if substantially modified to the extent that it firstly needed a new connection agreement (which is hard to envisage and is subject to Ofgem resolution of dispute under licence condition C9) and secondly that equipment would have been replaced to such an extent that complying with any requirements in DCC would not be a likely issue.
10	Do you agree that the DRSC reflects the requirements of DCC and provides sufficient information for Demand Response Providers. If not, please state why do not believe this to be the case and what you believe would provide a better alternative.	Yes, however, if improvements are identified during this consultation we will of course take the feedback on board and make changes where appropriate.
11	If you do not believe the proposal sufficiently discharges DCC obligations, can you please provide examples where this is the case?	We believe the proposal sufficiently discharges DCC obligations.
12	<p>Consultation question specifically for Transmission Licensees</p> <p>As a Transmission Licensee, are there any aspects of this consultation you do not agree with from a Transmission Licensees perspective? In particular do you have any comments with regard to DCC Articles 28 and 29 in particular Article 29(2)(d) where there is a requirement for the relevant TSO to consult with TSO's in the Synchronous Area.</p>	No, we support this process and consultation which gives further opportunity for engagement with all GB synchronous area TSOs as has also been afforded through the workgroup and will continue in the Code Administrator consultation that will follow conclusion of the workgroup.
	Legal text comments	
	<i>If you believe there are issues in the legal text, can you please bring these to our attention by using the space provided on the response proforma. These will then be discussed at the GC0104 legal text session planned following</i>	

	<i>the closure of this Consultation.</i>	
--	---	--

Grid Code Workgroup Consultation Response Proforma

GC0104 EU Connection Codes GB Implementation – Demand Connection Code

Industry parties are invited to respond to this consultation expressing their views and supplying the rationale for those views, particularly in respect of any specific questions detailed below.

Please send your responses by **5pm** on **29 March 2018** to grid.code@nationalgrid.com. Please note that any responses received after the deadline or sent to a different email address may not receive due consideration by the Workgroup.

Any queries on the content of the consultation should be addressed to Chrissie Brown at Christine.brown1@nationalgrid.com

Respondent:	Alan Creighton
Company Name:	Northern Powergrid
<p>Please express your views regarding the Workgroup Consultation, including rationale.</p> <p>(Please include any issues, suggestions or queries)</p>	<p><i>For reference, the Grid Code objectives are:</i></p> <ul style="list-style-type: none"> i. To permit the development, maintenance and operation of an efficient, coordinated and economical system for the transmission of electricity ii. To facilitate competition in the generation and supply of electricity (and without limiting the foregoing, to facilitate the national electricity transmission system being made available to persons authorised to supply or generate electricity on terms which neither prevent nor restrict competition in the supply or generation of electricity) iii. Subject to sub-paragraphs (i) and (ii), to promote the security and efficiency of the electricity generation, transmission and distribution systems in the national electricity transmission system operator area taken as a whole iv. To efficiently discharge the obligations imposed upon the licensee by this license and to comply with the Electricity Regulation and any relevant legally binding decisions of the European Commission and/or the Agency; and v. To promote efficiency in the implementation and administration of the Grid Code arrangements

Standard Workgroup Consultation questions

Q	Question	Response
1	Do you believe that GC0104 Original proposal, or any potential alternatives for change that you wish to suggest, better	Yes

	facilitates the Grid Code Objectives?	
2	Do you support the proposed implementation approach?	Yes
3	Do you have any other comments?	Demand side response services are in their infancy. The drafting of requirements into GB codes should do no more than reflect the absolute basics of the DCC, leaving as much scope as possible for technical and commercial innovation in delivering such services. The consultation drafting of the Grid and Distribution Code appears to achieve this balance, and it would inappropriate to press for more detail to be included at this time.
4	Do you wish to raise a WG Consultation Alternative Request for the Workgroup to consider?	Yes. A WG Consultation Alternative Request forms part of our consultation response.

Specific GC0104 questions

Q	Question	Response
5	Do you agree that DNOs should only implement the Demand Response requirements relating to Demand Response Active Power Control and Demand Response Reactive Power Control, recognizing that the other DSR services in Article 27 are services for the Transmission System Operator?	Yes.
6	Are the rights and obligations of aggregators appropriately allowed for in the drafting of ECC and DPC9? If not, what additional provisions would you suggest?	Given the immaturity of such services, it is inappropriate to consider creating more detailed requirements at this time, which might stifle appropriate commercial development of services.
7	Do you have any comments on the approach taken with the Installation Document pro-forma proposed for Demand Response services contracted to DNOs? Do you agree that there is no distinction necessary here for HV or LV customers?	We have no comments on the approach taken re the providers of services to DNOs and the System Operator. We agree that this is no need to distinguish between service providers connected at HV and LV.
8	Do you have any views on how	Not at this time.

	to tailor the compliance process, and documentation, to accommodate both individual Demand Response Service Providers and those Demand Response Service Providers who are aggregators?	
9	Can you see any issues with treating GSPs and EU GSP's in the way set out in the Glossary and Definitions and European Connection Conditions of the solution?	Yes. The WG Consultation Alternative Request which forms part of our consultation response seeks to address this issue.
10	Do you agree that the DRSC reflects the requirements of DCC and provides sufficient information for Demand Response Providers. If not, please state why do not believe this to be the case and what you believe would provide a better alternative.	Yes.
11	If you do not believe the proposal sufficiently discharges DCC obligations, can you please provide examples where this is the case?	The proposal seems adequate for compliance with the DCC.
12	<p>Consultation question specifically for Transmission Licensees</p> <p>As a Transmission Licensee, are there any aspects of this consultation you do not agree with from a Transmission Licensees perspective? In particular do you have any comments with regard to DCC Articles 28 and 29 in particular Article 29(2)(d) where there is a requirement for the relevant TSO to consult with TSO's in the Synchronous Area.</p>	N/A
	Legal text comments	
	<i>If you believe there are issues in the legal text, can you please bring these to our attention by using the space provided on the response proforma. These will then be discussed at the GC0104 legal text session planned following the closure of this</i>	See below:

Marked versions of the following consultation documents containing comments on the legal text are attached as part of this consultation response:

Distribution Code

DPC9

DRUD

Grid Code

Glossary and Definitions

DRC

DRSC

DRUD

ECC

ECP

PC

Alternative request Proposal form

Grid Code

Modification potential alternative submitted to:

What stage is this document at?

GC0104 – WACM1

01	Proposed alternative
02	Formal Workgroup alternative

Mod Title: EU Connection Codes GB Implementation – Demand Connection Code – clarifying the application to existing Grid Supply Points

Purpose of alternative Proposal:

The purpose of this Alternative Proposal is the same as the Original Proposal and to clarify the application of the DCC when work is proposed to existing Grid Supply Points.

Date submitted to Code Administrator: 29 March 2019

You are: A Workgroup member

Workgroup vote outcome: Formal alternative/not alternative

(Should your potential alternative become a formal alternative it will be allocated a reference)



Any Questions?

Contact:

Chrissie Brown

Code Administrator



Christine.brown1@nationalgrid.com

Code Administrator



01926 65 3328

Alternative Proposer(s):

Alan Creighton

Northern Powergrid



alan.creighton@northernpowergrid.com



01977 605290

Contents

1	Alternative proposed solution for workgroup review.....	1
2	Difference between this proposal and Original	2
3	Justification for alternative proposal against Grid Code objectives	4
4	Impacts and Other Considerations.....	5
5	Implementation	5
6	Legal Text.....	5

Should you require any guidance or assistance with this form and how to complete it please contact the Code Administrator at grid.code@nationalgrid.com

1 Alternative proposed solution for workgroup review

This Alternative seeks to implement the changes required to implement DCC as set out in the Original Proposal and to clarify the application of the DCC when work is proposed to existing Grid Supply Points.

2 Difference between this proposal and Original

The draft text included in the Workgroup Consultation would result in an existing Grid Supply Point being treated as an EU Grid Supply Point under the Grid Code in circumstances where Commission Regulation (EU) 2016/1388 (the “Regulation”) is clear it should not be treated as such. The Regulation is EU law and the Grid Code must not be drafted so as to conflict with it.

Article 3 of the Regulation states that:

The connection requirements set out in this Regulation shall apply to:

- (a) *new transmission-connected demand facilities;*
- (b) *new transmission-connected distribution facilities;*
- (c) *new distribution systems, including new closed distribution systems;*
- (d) *new demand units used by a demand facility or a closed distribution system to provide demand response services to relevant system operators and relevant TSOs.*

Article 4 1 of the Regulation states that:

*Existing transmission-connected demand facilities, **existing transmission-connected distribution facilities**, existing distribution systems and existing demand units that are or can be used by a demand facility or a closed distribution system to provide demand response services to a relevant system operator or relevant TSO, **are not subject to the requirements of this Regulation, except where:***

(a) *an existing transmission-connected demand facility, an existing transmission-connected distribution facility, an existing distribution system, or an existing demand unit within a demand facility at a voltage level above 1000 V or a closed distribution system connected at a voltage level above 1000 V, **has been modified to such an extent that its connection agreement must be substantially revised in accordance with the following procedure:***

(i) *demand facility owners, DSOs, or CDSOs **who intend to undertake the modernisation of a plant or replacement of equipment impacting the technical capabilities of the transmission-connected demand facility**, the transmission-connected distribution facility, the distribution system, or the demand unit shall **notify their plans to the relevant system operator in advance:***

(ii) *if the relevant system operator considers that the extent of the modernisation or replacement of equipment is such that a new connection agreement is required, the system operator shall notify*

the relevant regulatory authority or, where applicable, the Member State; and

(iii) the relevant regulatory authority or, where applicable, the Member State shall decide if the existing connection agreement needs to be revised or a new connection agreement is required and which requirements of this Regulation shall apply; or

(b) a regulatory authority or, where applicable, a Member State decides to make an existing transmission-connected demand facility, an existing transmission-connected distribution facility, an existing distribution system, or an existing demand unit subject to all or some of the requirements of this Regulation, following a proposal from the relevant TSO in accordance with paragraphs 3, 4 and 5.

Article 4 2 of the Regulation states that:

*For the purposes of this Regulation, a transmission-connected demand facility, a **transmission-connected distribution facility**, a distribution system, or a demand unit that is, or can be, used by a demand facility or a closed distribution system to provide demand response services to a relevant system operator or relevant TSO, **shall be considered as existing if:***

(a) it is already connected to the network on the date of entry into force of this Regulation; or

*(b) the demand facility owner, DSO, or CDSO **has concluded a final and binding contract for the purchase of the main demand equipment or the demand unit by two years after the entry into force of the Regulation**. The demand facility owner, DSO, or CDSO must notify the relevant system operator and relevant TSO of the conclusion of the contract within 30 months after the entry into force of the Regulation.*

Article 59 of the Regulation states that:

*This Regulation shall enter into force on the twentieth day following that of its publication in the Official Journal of the European Union. Without prejudice to Article 4(2)(b), Article 6, Article 51, Article 56 and Article 57, **the requirements of this Regulation shall apply from three years after publication**.*

[Emphasis added]

Consequently, the Regulation applies to:

- (a) new distribution assets at GSPs where none of the contracts for the main equipment are placed before 7 September 2018;*
- (b) new distribution assets at GSPs where none of the assets are connected before 7 September 2019; and*
- (c) existing distribution assets at GSPs where on or after 7 September 2019 (i) the assets are modified to such an extent that the relevant*

connection agreement must be substantially modified and (ii) the distributor initiated the modification.

The following draft text included in the Workgroup Consultation defines an EU GSP as follows:

EU Grid Supply Point	<p>A point of supply from the National Electricity Transmission System to Network Operators or Non-Embedded Customers where:-</p> <ul style="list-style-type: none"> (i) the Network Operator or Non Embedded Customer had placed Purchase Contracts for its Main Plant and Apparatus at that Grid Supply Point on or after 7 September 2018 or (ii) the Network Operators or Non Embedded Customers Main Plant and Apparatus at that Grid Supply Point was first connected to the Transmission System on or after 7 September 2019 or (iii) the Network Operator or Non Embedded Customer is the subject of a Substantial Modification at that Grid Supply Point on or after 7 September 2019.
-----------------------------	--

This attempts to set out the three scenarios whereby a GSP would be treated as an EU GSP (the effect of which is to subject the GSP to the provisions of the Regulation). However, the three limbs must be amended so that they correctly reflect the Regulation.

3 Justification for alternative proposal against Grid Code objectives

As per the Original Proposal.

Impact of the modification on the Relevant Objectives:	
Relevant Objective	Identified impact
To permit the development, maintenance and operation of an efficient, coordinated and economical system for the transmission of electricity	Positive
To facilitate competition in the generation and supply of electricity (and without limiting the foregoing, to facilitate the national electricity transmission system being made available to persons authorised to supply or generate electricity on terms which neither prevent nor restrict competition in the supply or generation of electricity)	Positive

Subject to sub-paragraphs (i) and (ii), to promote the security and efficiency of the electricity generation, transmission and distribution systems in the national electricity transmission system operator area taken as a whole	Positive/
To efficiently discharge the obligations imposed upon the licensee by this license and to comply with the Electricity Regulation and any relevant legally binding decisions of the European Commission and/or the Agency; and	Positive
To promote efficiency in the implementation and administration of the Grid Code arrangements	Neutral

This change will impact the relevant Code objectives as per the Original Proposal.

4 Impacts and Other Considerations

The Alternative Proposal will ensure that the DCC does not conflict with the Regulation and, therefore, with EU law.

Consumer Impacts

As per the Original Proposal.

5 Implementation

As per the Original Proposal.

6 Legal Text

The proposed text to implement this Alternative Proposal is as per the Original Proposal but with the following amendments to the definitions.

<p>EU Grid Supply Point</p>	<p>A point of supplyGrid Supply Point from the National Electricity Transmission System to Network Operators or Non-Embedded Customers where:-</p> <ul style="list-style-type: none"> (i) the Network Operator or Non Embedded Customer had <u>not</u> placed Purchase Contracts for <u>any of</u> its Main Plant and Apparatus at that Grid Supply Point on or after<u>before</u> 7 September 2018; or (ii) <u>none of</u> the Network Operator's or Non Embedded Customer's Main Plant and Apparatus at that Grid Supply Point was first connected to the Transmission System on or after<u>before</u> 7 September 2019; or (iii) there is Network Operator or Non-Embedded Customer <u>is</u> a <u>completed</u> Substantial Modification at that Grid Supply Point on or after 7 September 2019.
------------------------------------	---

<p>Grid Supply Point</p>	<p>A point of supply from the National Electricity Transmission System to Network Operators or Non-Embedded Customers.</p>
---------------------------------	---

<p>Main Plant and Apparatus</p>	<p>In respect of a Power Station (including Power Stations comprising of DC Connected Power Park Modules) is one or more of the principle<u>principal</u> items of Plant or Apparatus required to convert the primary source of energy into electricity.</p> <p>In respect of HVDC Systems or DC Converters or Transmission DC Converters is one of the principle<u>principal</u> items of Plant or Apparatus used to convert high voltage direct current to high voltage alternating current or vice versa<u>visa-vice</u> versa.</p> <p>In respect of Network Operators equipment or Non-Embedded Customers equipment, is one of the principle<u>principal</u> items of Plant or Apparatus required at each EUGrid Supply Point to facilitate the import or export of Active Power or Reactive Power to a Network Operators or Non Embedded Customer's System.</p>
--	--

<p>Substantial Modification</p>	<p>A Modification in relation to modernisation or replacement of the User's Main Plant and Apparatus, which, following notification by the relevant User to NGET, results in substantial amendment to the Bilateral Agreement.</p>
--	---

Modification	Any actual or proposed replacement, renovation, modification, alteration or construction by or on behalf of a User or NGET to either that User's Plant or Apparatus or Transmission Plant or Apparatus , as the case may be, or the manner of its operation which has or may have a Material Effect on NGET or a User , as the case may be, at a particular Connection Site .
---------------------	---

Grid Code Workgroup Consultation Response Proforma

GC0104 EU Connection Codes GB Implementation – Demand Connection Code

Industry parties are invited to respond to this consultation expressing their views and supplying the rationale for those views, particularly in respect of any specific questions detailed below.

Please send your responses by **5pm** on **29 March 2018** to grid.code@nationalgrid.com. Please note that any responses received after the deadline or sent to a different email address may not receive due consideration by the Workgroup.

Any queries on the content of the consultation should be addressed to Chrissie Brown at Christine.brown1@nationalgrid.com

Respondent:	<i>Tim Ellingham Windmill Hill Swindon SN7 7LR</i>
Company Name:	<i>RWE Supply and Trading</i>
Please express your views regarding the Workgroup Consultation, including rationale. (Please include any issues, suggestions or queries)	<p><i>For reference, the Grid Code objectives are:</i></p> <ul style="list-style-type: none"> i. To permit the development, maintenance and operation of an efficient, coordinated and economical system for the transmission of electricity ii. To facilitate competition in the generation and supply of electricity (and without limiting the foregoing, to facilitate the national electricity transmission system being made available to persons authorised to supply or generate electricity on terms which neither prevent nor restrict competition in the supply or generation of electricity) iii. Subject to sub-paragraphs (i) and (ii), to promote the security and efficiency of the electricity generation, transmission and distribution systems in the national electricity transmission system operator area taken as a whole iv. To efficiently discharge the obligations imposed upon the licensee by this license and to comply with the Electricity Regulation and any relevant legally binding decisions of the European Commission and/or the Agency; and v. To promote efficiency in the implementation and administration of the Grid Code arrangements. <p><i>The Distribution Code objectives are:</i></p> <ul style="list-style-type: none"> i. Permit the development, maintenance, and operation of an efficient, coordinated and economical System for the distribution of electricity. ii. Facilitate competition in the generation and supply of

	<p>electricity.</p> <p>iii. Efficiently discharge the obligations imposed upon DNOs by the Distribution Licence and comply with the Regulation (where Regulation has the meaning defined in the Distribution Licence) and any relevant legally binding decision of the European Commission and/or Agency for the Co-operation of Energy Regulators.</p> <p>iv. Promote efficiency in the implementation and administration of the Distribution Code.</p>
--	--

Standard Workgroup Consultation questions

Q	Question	Response
1	Do you believe that GC0104 Original proposal, or any potential alternatives for change that you wish to suggest, better facilitates the Grid Code Objectives?	Not quite depending on how storage is handled, competition may be affected. Competition would also be affected if Units in the UK are subject to more stringent rules, due to a Substantial Modification, which are not applied across the continent.
2	Do you support the proposed implementation approach?	I am broadly ok with the proposal less the points I have raised.
3	Do you have any other comments?	I am not clear on how battery storage is to be handled in respect to when it is exporting. Is it a demand site or a Power Generating Module, over a full cycle it would be a net demand unit, and not being a pump storage unit it would then be a demand site. However, how are negative demands handled? I see no mention of such a thing in the EU code or in the 104 implementation, should there be something explicit?
4	Do you wish to raise a WG Consultation Alternative Request for the Workgroup to consider?	Would more likely be a new modification <i>If yes, please complete a WG Consultation Alternative Request form, available on National Grid's website,</i> https://www.nationalgrid.com/uk/electricity/codes/grid-code and return to the Grid Code inbox at grid.code@nationalgrid.com

Specific GC0104 questions

Q	Question	Response
5	Do you agree that DNOs should only implement the Demand Response requirements relating	

	to Demand Response Active Power Control and Demand Response Reactive Power Control, recognizing that the other DSR services in Article 27 are services for the Transmission System Operator?	
6	Are the rights and obligations of aggregators appropriately allowed for in the drafting of ECC and DPC9? If not, what additional provisions would you suggest?	
7	Do you have any comments on the approach taken with the Installation Document pro-forma proposed for Demand Response services contracted to DNOs? Do you agree that there is no distinction necessary here for HV or LV customers?	
8	Do you have any views on how to tailor the compliance process, and documentation, to accommodate both individual Demand Response Service Providers and those Demand Response Service Providers who are aggregators?	
9	Can you see any issues with treating GSPs and EU GSP's in the way set out in the Glossary and Definitions and European Connection Conditions of the solution?	
10	Do you agree that the DRSC reflects the requirements of DCC and provides sufficient information for Demand Response Providers. If not, please state why do not believe this to be the case and what you believe would provide a better alternative.	
11	If you do not believe the proposal sufficiently discharges DCC obligations, can you please provide examples where this is the case?	
12	Consultation question specifically for Transmission Licensees	

	<p>As a Transmission Licensee, are there any aspects of this consultation you do not agree with from a Transmission Licensees perspective? In particular do you have any comments with regard to DCC Articles 28 and 29 in particular Article 29(2)(d) where there is a requirement for the relevant TSO to consult with TSO's in the Synchronous Area.</p>	
	<p>Legal text comments</p>	
	<p><i>If you believe there are issues in the legal text, can you please bring these to our attention by using the space provided on the response proforma. These will then be discussed at the GC0104 legal text session planned following the closure of this Consultation.</i></p>	

Definition of EU Code user, EU Grid Supply Point, Substantial Modification and Application to existing

As with the implementation of the RfG (631/2016) we find that the test applied for evaluation of a Supply Point to become an EU Code User or EU Grid Supply Point does not accurately reflect the wording in 2016/1388.

As with 2016/631 the trigger for becoming, either, an EU Code User or EU Grid Supply Point is the requirement, and approval of, a NEW connection agreement. Substantial Modification is not a term in 2016/1388. The following is the key step from 2016/1388 Article 4.1.a

- (ii) if the relevant system operator considers that the extent of the modernisation or replacement of equipment is such that a **new** connection agreement is required, the system operator shall notify the relevant regulatory authority or, where applicable, the Member State; and

EU Code User	<p>(h) A Network Operator whose total System was first connected to the Transmission System after 7 September 2010 or who had placed Purchase Contracts for its Main Plant and Apparatus after 7 September 2018 or had substantially Substantially Modified their Network Operators System after 7 September 2019.</p> <p>(i)(h) A Network Operator who's connects a new substation-entire distribution System was first connected to the Transmisison System on or after 7 September 2019 or who had placed Purchase Contracts for its Main Plant and Apparatus in respect of its entiretotal distribution System Main Plant and Apparatus after 7 September 2018, in respect of a new Substation or had substantially Substantially Modified their Transmission connected-substation after 7 September 2019. In this case, a Network Operators entire System would only have EU Grid Supply Points at each Connection Point with the National Electricity Transmission System.</p> <p>(i)(i) A Non Embedded Customer who's Main Plant and Apparatus at each EU Grid Supply Point was first connected to the Transmission System after 7 September 2019 or who had placed Purchase Contracts for its Main Plant and Apparatus at each EU Grid Supply Point on or after 7 September 2018 or is the subject of a had-substantially Substantially Modificationeend their Plant and Apparatus on or after 7 September 2019.</p>
EU Generator	A Generator or OTSDUA who is also an EU Code User.
EU Grid Supply Point	<p>A point of supply from the National Electricity Transmission System to Network Operators or Non-Embedded Customers where:-</p> <p>(i) the Network Operator or Non Embedded Customer had placed Purchase Contracts for its Main Plant and Apparatus at that Grid Supply Point on or after 7 September 2018 or</p> <p>(ii) the Network Operators or Non Embedded Customers Main Plant and Apparatus at that Grid Supply Point was first connected to the Transmission System on or after 7 September 2019 or</p> <p>(iii) the Network Operator or Non Embedded Customer is the subject of a Substantial Modification at that Grid Supply Point on or after 7 September 2019.</p>

Substantial Modification in itself is poorly defined,

Substantial Modification	<p>A Modification in relation to modernisation or replacement of the User's Main Plant and Apparatus, which, following notification by the relevant User to NGET, results in substatantial amendment to the Bilateral Agreement and which need not have a Material Effect on NGET or a User.</p>
--------------------------	--

What is a substantial amendment to a Bilateral Agreement? Not that it should matter as the test should be for a NEW Bilateral Agreement. If the term and process around Substantial Modification is kept then Ofgem risk incurring more referrals due to disagreements over whether the change was sunstantial or not. Having the decision based around the need for a 'NEW' Agreement will only end up referring the few occassions when a new agreement is actually required.

Grid Code Workgroup Consultation Response Proforma

GC0104 EU Connection Codes GB Implementation – Demand Connection Code

Industry parties are invited to respond to this consultation expressing their views and supplying the rationale for those views, particularly in respect of any specific questions detailed below.

Please send your responses by **5pm** on **29 March 2018** to grid.code@nationalgrid.com. Please note that any responses received after the deadline or sent to a different email address may not receive due consideration by the Workgroup.

Any queries on the content of the consultation should be addressed to Chrissie Brown at Christine.brown1@nationalgrid.com

Respondent:	Alastair Frew
Company Name:	ScottishPower Generation
<p>Please express your views regarding the Workgroup Consultation, including rationale.</p> <p>(Please include any issues, suggestions or queries)</p>	<p><i>For reference, the Grid Code objectives are:</i></p> <ul style="list-style-type: none"> i. To permit the development, maintenance and operation of an efficient, coordinated and economical system for the transmission of electricity ii. To facilitate competition in the generation and supply of electricity (and without limiting the foregoing, to facilitate the national electricity transmission system being made available to persons authorised to supply or generate electricity on terms which neither prevent nor restrict competition in the supply or generation of electricity) iii. Subject to sub-paragraphs (i) and (ii), to promote the security and efficiency of the electricity generation, transmission and distribution systems in the national electricity transmission system operator area taken as a whole iv. To efficiently discharge the obligations imposed upon the licensee by this license and to comply with the Electricity Regulation and any relevant legally binding decisions of the European Commission and/or the Agency; and v. To promote efficiency in the implementation and administration of the Grid Code arrangements. <p><i>The Distribution Code objectives are:</i></p> <ul style="list-style-type: none"> i. Permit the development, maintenance, and operation of an efficient, coordinated and economical System for the distribution of electricity. ii. Facilitate competition in the generation and supply of electricity. iii. Efficiently discharge the obligations imposed upon DNOs by the Distribution Licence and comply with the

	<p>Regulation (where Regulation has the meaning defined in the Distribution Licence) and any relevant legally binding decision of the European Commission and/or Agency for the Co-operation of Energy Regulators.</p> <p>iv. Promote efficiency in the implementation and administration of the Distribution Code.</p>
--	---

Standard Workgroup Consultation questions

Q	Question	Response
1	Do you believe that GC0104 Original proposal, or any potential alternatives for change that you wish to suggest, better facilitates the Grid Code Objectives?	Yes
2	Do you support the proposed implementation approach?	Yes
3	Do you have any other comments?	No
4	Do you wish to raise a WG Consultation Alternative Request for the Workgroup to consider?	<p><i>If yes, please complete a WG Consultation Alternative Request form, available on National Grid's website,</i></p> <p>https://www.nationalgrid.com/uk/electricity/codes/grid-code and return to the Grid Code inbox at grid.code@nationalgrid.com</p>

Specific GC0104 questions

Q	Question	Response
5	Do you agree that DNOs should only implement the Demand Response requirements relating to Demand Response Active Power Control and Demand Response Reactive Power Control, recognizing that the other DSR services in Article 27 are services for the Transmission System Operator?	
6	Are the rights and obligations of aggregators appropriately allowed for in the drafting of ECC and DPC9? If not, what additional provisions would you suggest?	

7	<p>Do you have any comments on the approach taken with the Installation Document pro-forma proposed for Demand Response services contracted to DNOs?</p> <p>Do you agree that there is no distinction necessary here for HV or LV customers?</p>	<p>All DRS need to be treated the same way along with other service providers supply services via existing routes.</p>
8	<p>Do you have any views on how to tailor the compliance process, and documentation, to accommodate both individual Demand Response Service Providers and those Demand Response Service Providers who are aggregators?</p>	<p>There will also be SOGL prequalification requirements for Demand Response Service Providers which will need to be added somewhere.</p>
9	<p>Can you see any issues with treating GSPs and EU GSP's in the way set out in the Glossary and Definitions and European Connection Conditions of the solution?</p>	<p>No</p>
10	<p>Do you agree that the DRSC reflects the requirements of DCC and provides sufficient information for Demand Response Providers. If not, please state why do not believe this to be the case and what you believe would provide a better alternative.</p>	
11	<p>If you do not believe the proposal sufficiently discharges DCC obligations, can you please provide examples where this is the case?</p>	
12	<p>Consultation question specifically for Transmission Licensees</p> <p>As a Transmission Licensee, are there any aspects of this consultation you do not agree with from a Transmission Licensees perspective? In particular do you have any comments with regard to DCC Articles 28 and 29 in particular Article 29(2)(d) where there is a requirement for the relevant TSO to consult with TSO's in the Synchronous Area.</p>	

	Legal text comments	
	<p><i>If you believe there are issues in the legal text, can you please bring these to our attention by using the space provided on the response proforma. These will then be discussed at the GC0104 legal text session planned following the closure of this Consultation.</i></p>	<p>Definitions section</p> <p>Compliance Statement</p> <p>Change the following paragraph as follows “Network Operators Total System where such Network Operators Total System comprises solely of Plant and Apparatus procured after 7 September 2018 or and was connected to the National Electricity Transmission System after 7 September 2019. In this case, all connections to the National Electricity Transmission System would comprise only of EU Grid Supply Points; or”</p> <p>Demand Response Provider</p> <p>Change one paragraph as follows “A party (other than NGET) who’s Main Plant and Apparatus was first connected to the Total System on or after 7 September 2019, or and who had placed Purchase Contracts for its Main Plant and Apparatus after 7 September 2018 or is the subject of a Substantial Modification on or after 7 September 2019 and has an agreement with NGET to provide a Demand Response Service(s).</p> <p>EU Code User</p> <p>Change the following 2 paragraphs as follows “(h) A Network Operator who’s entire distribution System was first connected to the Transmission System on or after 7 September 2019 or and who had placed Purchase Contracts for its Main Plant and Apparatus in respect of its entire distribution System after 7 September 2018.”</p> <p>“(i) A Non Embedded Customer who’s Main Plant and Apparatus at each EU Grid Supply Point was first connected to the Transmission System after 7 September 2019 or and who had placed Purchase Contracts for its Main Plant and Apparatus at each EU Grid Supply Point on or after 7 September 2018”</p> <p>EU Grid Supply Point</p> <p>Definition needs to be rewritten to get the ors and ands correct as follows A point of supply from the National Electricity Transmission System to Network Operators or Non-Embedded Customers where:- the Network Operators or Non Embedded Customers Main Plant and Apparatus at that Grid Supply Point was first connected to the Transmission System on or after 7 September 2019 and had placed Purchase Contracts for its Main Plant and Apparatus at that Grid Supply Point on or after 7 September 2018, or is the subject of a Substantial Modification at that Grid Supply Point on or after 7 September 2019.</p> <p>GB Code User</p> <p>Subparagraph (d) date for substantial modification needs changed from 2018 to 2019.</p>

		<p>Substantial Modification</p> <p>To deal with various difficulties with DCC text (and RfG & HVDC) this definition may work better</p> <p>A Modification in relation to modernisation or replacement of the User's Main Plant and Apparatus, which, following notification by the relevant User to NGET, results in NGET notifying the Authority that they believe a new connection agreements is required and the Authority agreeing.</p>
--	--	--

Grid Code Workgroup Consultation Response Proforma

GC0104 EU Connection Codes GB Implementation – Demand Connection Code

Industry parties are invited to respond to this consultation expressing their views and supplying the rationale for those views, particularly in respect of any specific questions detailed below.

Please send your responses by **5pm** on **29 March 2018** to grid.code@nationalgrid.com. Please note that any responses received after the deadline or sent to a different email address may not receive due consideration by the Workgroup.

Any queries on the content of the consultation should be addressed to Chrissie Brown at Christine.brown1@nationalgrid.com

Respondent:	<i>Garth Graham (garth.graham@sse.com)</i>
Company Name:	<i>SSE Generation Ltd.</i>
<p>Please express your views regarding the Workgroup Consultation, including rationale.</p> <p>(Please include any issues, suggestions or queries)</p>	<p><i>For reference, the Grid Code objectives are:</i></p> <ul style="list-style-type: none"> i. To permit the development, maintenance and operation of an efficient, coordinated and economical system for the transmission of electricity ii. To facilitate competition in the generation and supply of electricity (and without limiting the foregoing, to facilitate the national electricity transmission system being made available to persons authorised to supply or generate electricity on terms which neither prevent nor restrict competition in the supply or generation of electricity) iii. Subject to sub-paragraphs (i) and (ii), to promote the security and efficiency of the electricity generation, transmission and distribution systems in the national electricity transmission system operator area taken as a whole iv. To efficiently discharge the obligations imposed upon the licensee by this license and to comply with the Electricity Regulation and any relevant legally binding decisions of the European Commission and/or the Agency; and v. To promote efficiency in the implementation and administration of the Grid Code arrangements. <p><i>The Distribution Code objectives are:</i></p> <ul style="list-style-type: none"> i. Permit the development, maintenance, and operation of an efficient, coordinated and economical System for the distribution of electricity. ii. Facilitate competition in the generation and supply of electricity. iii. Efficiently discharge the obligations imposed upon DNOs by the Distribution Licence and comply with the

	<p>Regulation (where Regulation has the meaning defined in the Distribution Licence) and any relevant legally binding decision of the European Commission and/or Agency for the Co-operation of Energy Regulators.</p> <p>iv. Promote efficiency in the implementation and administration of the Distribution Code.</p>
--	---

Standard Workgroup Consultation questions

Q	Question	Response
1	Do you believe that GC0104 Original proposal, or any potential alternatives for change that you wish to suggest, better facilitates the Grid Code Objectives?	Given that the proposal is currently deficient in terms of the lack of detail around the technical requirements that new Transmission-connected Demand Facilities, new Transmission-connected Distribution Facilities, new Distribution Systems and new Demand Units used by a Demand Facility or a Closed Distribution System to provide Demand Response Services to System Operators have to comply with we can't therefore say that we believe that GC0104 does better facilitate the applicable Grid Code Objectives.
2	Do you support the proposed implementation approach?	<p>We note the recent public statement of the Commission that, in accordance with the existing transparency rules (set out in Directive 2015/1535), the technical requirements associated with the European Connection Codes (RfG, DCC and HVDC) <u>are</u> required to be notified to them (the Commission) and the other Member States (as per 2015/1535) three months <u>in advance</u> of them being applied in the Member State.</p> <p>Given that the stated purpose of GC0104 is (according to proposal) to set out the technical requirements for new users this means, as the Commission has noted, that the legal obligations as set out in Directive 2015/1535 are applicable to GC0104.</p> <p>Only if the proposed GC0104 implementation approach fully accords with this (2015/1535) (i.e. includes all technical requirements <i>within the Grid Code</i> rather than specific technical requirements (parameters) being referred to within BCAs) requirement can we support it.</p>
3	Do you have any other comments?	<p>We note that the title page of this GC0104 Workgroup consultation states that:</p> <p><i>“Purpose of Modification:</i> <i><u>This modification will set out within the Grid and Distribution Codes the following compliance</u></i></p>

obligations in the European Network Code – Demand Connection Code (DCC):

1. Technical requirements for new Transmission-connected Demand Facilities; Transmission-connected Distribution Facilities and Distribution Systems.*

2. Technical requirements for Demand Units used by a Demand Facility or a Closed Distribution System to provide Demand Response Services to System Operators.” [emphasis added]

A similar point (that GC0104 was to address the technical requirements of the DCC) was made in the opening moments of the webinar / podcast held by the Proposer on 21st March 2018.

However, what is striking is the lack of detail of the complete actual technical requirements themselves (including country specific parameters) within the consultation document itself and the associated legal text.

This lack of technical detail (which is, apparently, to be provided in later documents – such as a future version of the ‘Ancillary Services agreement’) has severely limited our (and other stakeholders) ability to respond meaningfully to this consultation. It has also unduly restricted our ability to raise WG Consultation Alternative Request(s) for the Workgroup to consider as we cannot see the complete technical requirements detailed in the Original proposal (and thus determine what, if any, potential alternatives, we wish to raise).

Given that the TSO has had circa 18 months to develop the necessary complete technical requirements for the application of the DCC in GB it is disappointing that this is still not forthcoming,

In addition, the lack of detail provided on the part of the TSO would also appear to be contrary to Article 6(3) (b) of DCC as it fails to ensure transparency.

Furthermore this lack of detail points to the wider concern that harmonisation is not being applied, with the GC0104 proposal.

This lack of harmonisation in the GC0104 proposal will lead to increased costs for consumers, will not achieve the best social welfare outcome and will not be reasonable, proportionate or efficient.

		<p>We note that a key requirement of the DCC, which appears to be overlooked by the Proposer, is that</p> <p><i>“Harmonised rules for grid connection for demand facilities and distribution systems should be set out in order to provide a clear legal framework for grid connections, facilitate Union-wide trade in electricity, ensure system security, facilitate the integration of renewable electricity sources, increase competition, and allow more efficient use of the network and resources, for the benefit of consumers.”</i></p> <p>However, there appears to be a theme running through the GC0104 proposal that the TSO will agree ‘bespoke’ technical requirements and commercial terms for certain parties; such as some providers of DSR and / or some demand units and / or demand facilities; after September 2018 which dis-apply some or all of the DCC obligations¹ on those parties.</p> <p>Not only would this be discriminatory (which is contrary to Article 6(3) (a) of the DCC) it would also mean that these ‘bespoke’ technical requirements and commercial terms for certain parties would be hidden from all other stakeholders – this would be contrary to Article 6(3) (b) of DCC as it fails to ensure transparency. It would also be contrary to the requirements of harmonisation (as some providers of DSR would be obliged by the TSO to meet all the DCC requirements whilst other providers may not be equally obligated to meet all the DCC requirements, by the TSO).</p> <p>In this respect we note that the obligations on the DSR providers (as well as new connecting parties) set out in the DCC <i>override anything that they may ‘agree’ with the TSO.</i></p> <p>If this scenario (where ‘bespoke’ technical requirements and commercial terms for certain parties are ‘agreed’ with the TSO) were to arise, then the DSR provider(s) cannot rely on the fact that they have an ‘agreement’ with the TSO when considering their compliance with the DCC (which is not the same</p>
--	--	--

¹ Whilst GC0104 deals with the DCC we note that the definition of SGUs within SOGL makes reference to the DCC definition – DSR providers are thus bound by the SOGL obligations both as new and existing DSR providers. Accordingly, ‘bespoke’ technical requirements and commercial terms for certain parties proffered by the TSO whereby those parties are relieved from some or all of the SOGL obligations would, for the reasons set out here, be incompatible with the SOGL in the context of harmonisation, transparency and non discrimination.

		<p>as the proposed TSO's compliance approach set out in the GC0104 proposal).</p> <p>In respect of Article 4(1) (a) (iii) we note the statement at the bottom of page 27/ top of page 28 of the Workgroup consultation that :</p> <p><i>"In terms of Article 4(1), the working group discussed the issues (eg time delays, resource requirements) associated with Ofgem reviewing and determining whether parties should be treated as "new" or "existing" in all these cases . This was considered unnecessary where the generator and system operator agreed about its status. We considered that a practical interpretation of Article 4(1) was that we reviewed and decided whether parties should be treated "new" or "existing" where there was a dispute about whether the generator should be treated as "new" or "existing"."</i></p> <p>We make two observations.</p> <p>Firstly, Article 4(1) (a) (iii) requires that:</p> <p><i><u>"the relevant regulatory authority or, where applicable, the Member State shall decide if the existing connection agreement needs to be revised or a new connection agreement is required and which requirements of this Regulation shall apply"</u></i> [emphasis added]</p> <p>We see no wording in Article 4(1), or elsewhere in the DCC, that permits (even if the parties - the TSO and connecting party / DSR provider - all agree) this requirement on the NRA to be delegated, by the NRA, to any other party (or parties, with or without them being in agreement) and only to come to the NRA in the event of a dispute. Given this it appears that the duties in Article 4(1) (a) (iii) reside with the NRA alone and must be exercised accordingly by the NRA.</p> <p>Secondly, with respect to the suggested delegation of the 4(1) (a) (iii) requirements by the NRA, we note the statement from Ofgem in the recent P362 consultation document² (which looked at the possibility of delegating the Authority's statutory duties with regard to derogations to (in the case of</p>
--	--	--

² <https://www.elexon.co.uk/mod-proposal/p362/>

		<p>P362) the BSC Panel):</p> <p><i><u>“From a legal perspective my preliminary thoughts are that to permit such an approach may be unlawful on the basis that it would fetter the Authority’s discretion and/or purport to delegate the Authority’s functions to a 3rd party.</u></i></p> <p><i><u>The Authority is given statutory authority to issue and modify the transmission licence. The licence itself obligates to licence holder to create the code and tightly controls the circumstance within which those codes may be modified, with the Authority ultimately approving modifications in each case. Whilst a derogation may be time-limited, for a set period of time and directed for the benefit of one or more parties it nevertheless would modify the effect of the code for that party for the duration of the derogation. There is an argument therefore that a “derogation” is a type of modification, the delegation of which to 3rd party would be to delegate an important part of the Authority’s functions. We think that from a policy and legal perspective it is important that the Authority retains ultimate direction over the derogations process.”</u></i> [emphasis added]</p>
4	Do you wish to raise a WG Consultation Alternative Request for the Workgroup to consider?	<p><i>If yes, please complete a WG Consultation Alternative Request form, available on National Grid's website,</i></p> <p>https://www.nationalgrid.com/uk/electricity/codes/grid-code and return to the Grid Code inbox at grid.code@nationalgrid.com</p>

Specific GC0104 questions

Q	Question	Response
5	Do you agree that DNOs should only implement the Demand Response requirements relating to Demand Response Active Power Control and Demand Response Reactive Power Control, recognizing that the other DSR services in Article 27 are services for the Transmission System Operator?	<p>The approach to be followed by providers of demand response services should, according to the DCC, be harmonised. We see no recognition of this requirement for harmonisation by the Proposer of GC0104.</p> <p>Without this harmonisation there is a risk that DSR providers have to meet multiple requirements for the same demand modulation depending on whether it is provided to the relevant system operator or relevant TSO.</p> <p>As noted above, this lack of harmonisation in the GC0104 proposal will lead to increased costs for</p>

		consumers, will not achieve the best social welfare outcome and will not be reasonable, proportionate or efficient.
6	Are the rights and obligations of aggregators appropriately allowed for in the drafting of ECC and DPC9? If not, what additional provisions would you suggest?	Given the total lack of detail in this consultation around what the 'Ancillary Services agreement' requires of aggregators; in terms of the DCC; it is difficult to say what the rights and obligations, in totality, are and, therefore, it is difficult to say if this has been suitability allowed for in the drafting of ECC and DCP9.
7	Do you have any comments on the approach taken with the Installation Document pro-forma proposed for Demand Response services contracted to DNOs? Do you agree that there is no distinction necessary here for HV or LV customers?	<p>Given that the DCC obligations are to be harmonised then so should the documentation; i.e. it should not matter whether the service is provided to the relevant system operator or the relevant TSO, in both cases the form to be completed should be the same and should only need to be completed once.</p> <p>Notwithstanding the above, we note that the General Data Protection Regulation (GDPR) is due to be applicable in the near future. We notice that the draft installation document contains customer personal data – could the Proposer please confirm, in light of the GDPR obligations, that the proposed installation document is fully compliant with the GDPR obligations.</p>
8	Do you have any views on how to tailor the compliance process, and documentation, to accommodate both individual Demand Response Service Providers and those Demand Response Service Providers who are aggregators?	
9	Can you see any issues with treating GSPs and EU GSP's in the way set out in the Glossary and Definitions and European Connection Conditions of the solution?	<p>Reviewing the proposed definition in respect of 'EU Code User' it appears to have missed the scenario where a Network Operator has (i) new transmission connected distribution facilities or (ii) new distribution systems or (iii) has, according to Article 4(1) (a) (i), modernised or replaced equipment impacting the technical capabilities of an existing transmission connected distribution facility or <u>the</u> distribution system.</p> <p>In which case they would be classified as an 'EU Code User'. This does not appear to have been reflected in the treatment of GSPs and EU GSPs.</p>
10	Do you agree that the DRSC reflects the requirements of DCC and provides sufficient	We do <u>not</u> agree that the DRSC reflects the requirements of DCC and provides sufficient

	<p>information for Demand Response Providers. If not, please state why do not believe this to be the case and what you believe would provide a better alternative.</p>	<p>information for Demand Response Providers.</p> <p>The draft DSRC has multiple references to an 'Ancillary Services agreement'. However, the documentation of this 'Ancillary Services agreement', duly amended to reflect the requirements of the DCC, has not been provided as part of the Workgroup consultation. This has unduly impeded our ability to respond to this consultation (as we are, in effect, doing so whilst being 'blind' to all the technical requirements associated with DSR).</p> <p>Furthermore, from what little we have seen within the DSRC, it would seem that there has been a misunderstanding, on the part of the Proposer, around what DSR services fall within the remit of the DCC. Based on the definitions within Article 2 we can see that from the date of application of the DCC that <u>all new demand units</u> used by demand facilities that provide demand modulation to the relevant system operators or relevant TSOs will be required to comply with the DCC. It is not clear that the GC0104 proposal accepts this point.</p> <p>Furthermore, we note that Ofgem's CACoP principles do not apply to the governance of the 'Ancillary Services agreement'.</p> <p>In our view the technical requirements and associated terms and conditions for the entire DCC application in GB should be subject to open and transparent governance which is fully in accordance with CACoP including, in particular, the ability for stakeholders to propose amendments.</p> <p>However, as currently drafted within GC0104, this is not to occur - as a closed and non transparent governance approach applies to the 'Ancillary Services agreement' arrangements.</p>
11	<p>If you do not believe the proposal sufficiently discharges DCC obligations, can you please provide examples where this is the case?</p>	<p>The proposal does <u>not</u> sufficiently discharge the DCC obligations as it lacks all the necessary detail on the technical requirement that parties to whom the DCC applies will have to comply with. GC0104 should be the 'complete package' – however, it is not.</p> <p>Instead consultation respondents, the Workgroup, the GCRP and ultimately the Authority are being asked to sign, it would seem, a 'blank cheque' for the TSO to fill in (the necessary technical requirements)</p>

		<p>later.</p> <p>This is, unfortunately, a direct effect of the decision taken by the Proposer to apply a ‘policy’ approach’ rather than a ‘legal’ approach’ when it comes to implementing the European Network Codes within the GB industry codes.</p> <p>There are too many examples to list here; but suffice to say that an impartial review of the code mapping shows that the necessary actual technical detail needed by Users for many items within the DCC is still lacking in the GC0104 ‘solution’ to date.</p>
12	<p>Consultation question specifically for Transmission Licensees</p> <p>As a Transmission Licensee, are there any aspects of this consultation you do not agree with from a Transmission Licensees perspective? In particular do you have any comments with regard to DCC Articles 28 and 29 in particular Article 29(2)(d) where there is a requirement for the relevant TSO to consult with TSO’s in the Synchronous Area.</p>	N/A
	Legal text comments	
	<p><i>If you believe there are issues in the legal text, can you please bring these to our attention by using the space provided on the response proforma. These will then be discussed at the GC0104 legal text session planned following the closure of this Consultation.</i></p>	<p>In addition to all the points we noted above, which will need to be fully reflected into the legal text, we would additionally note the following:</p> <p>Why has the use of the term ‘EU Code User’ been deleted from the body of the text?</p> <p>That being the case, why has the definition of EU Code User been both retained and amended to seek to reflect the DCC?</p> <p>The definition of ‘Substantial Modification’ is incompatible with Article 4 (1) (a) (i) which requires that:</p> <p><i>“demand facility owners, DSOs, or CDSOs who intend to undertake the <u>modernisation of a plant or replacement of equipment impacting the technical capabilities</u> of the transmission-connected demand facility, the transmission-connected distribution facility, the distribution system, or the demand unit</i></p>

		<i>shall notify their plans to the relevant system operator in advance”</i>
--	--	--

GC0104 EU Connection Codes GB Implementation – Demand Connection Code

Industry parties are invited to respond to this consultation expressing their views and supplying the rationale for those views, particularly in respect of any specific questions detailed below.

Please send your responses by **5pm on 29 March 2018** to grid.code@nationalgrid.com. Please note that any responses received after the deadline or sent to a different email address may not receive due consideration by the Workgroup.

Any queries on the content of the consultation should be addressed to Chrissie Brown at Christine.brown1@nationalgrid.com

Respondent:	Grace Smith 0755 443 9689 Grace.smith@ukpowerreserve.co.uk
Company Name:	UK Power Reserve Ltd
Please express your views regarding the Workgroup Consultation, including rationale. (Please include any issues, suggestions or queries)	UKPR support this modification and believes it will better facilitate the Grid Code Objectives.

Standard Workgroup Consultation questions

Q	Question	Response
1	Do you believe that GC0104 Original proposal, or any potential alternatives for change that you wish to suggest, better facilitates the Grid Code Objectives?	Yes, UKPR believes that GC0104 better facilitates the Grid Code Objectives.
2	Do you support the proposed implementation approach?	Yes, UKPR is confident the modification has the correct implementation approach.
3	Do you have any other comments?	UKPR is concerned at the time taken to reach this stage of ensuring GB compliance to EU Regulations. There have been some process management issues that have potentially caused delays, but we are satisfied this modification will be implemented within a suitable timeframe.
4	Do you wish to raise a WG Consultation Alternative Request for the Workgroup to consider?	No, UKPR supports the modification proposal.

Specific GC0104 questions

Q	Question	Response
5	Do you agree that DNOs should only implement the Demand Response requirements relating to Demand Response Active Power Control and Demand Response Reactive Power Control, recognizing that the other DSR services in Article 27 are services for the Transmission System Operator?	Yes, although as the DNO-DSO transition evolves, they should not be precluded from future discussions.
6	Are the rights and obligations of aggregators appropriately allowed for in the drafting of ECC and DPC9? If not, what additional provisions would you suggest?	N/A
7	Do you have any comments on the approach taken with the Installation Document pro-forma proposed for Demand Response services contracted to DNOs? Do you agree that there is no distinction necessary here for HV or LV customers?	UKPR do not see any necessary distinction between LV and HV customers. At the moment, the nature of potential Demand Response services is unclear, but the proforma includes sufficient information.
8	Do you have any views on how to tailor the compliance process, and documentation, to accommodate both individual Demand Response Service Providers and those Demand Response Service Providers who are aggregators?	UKPR supports the approach taken in the Workgroup report.
9	Can you see any issues with treating GSPs and EU GSP's in the way set out in the Glossary and Definitions and European Connection Conditions of the solution?	No, UKPR believes the definitions are fit for purpose.
10	Do you agree that the DRSC reflects the requirements of DCC and provides sufficient information for Demand Response Providers. If not, please state why do not believe this to be the case and what you believe would provide a better alternative.	Yes, UKPR agrees the DRSC is fit for purpose.

11	If you do not believe the proposal sufficiently discharges DCC obligations, can you please provide examples where this is the case?	N/A
12	<p>Consultation question specifically for Transmission Licensees</p> <p>As a Transmission Licensee, are there any aspects of this consultation you do not agree with from a Transmission Licensees perspective? In particular do you have any comments with regard to DCC Articles 28 and 29 in particular Article 29(2)(d) where there is a requirement for the relevant TSO to consult with TSO's in the Synchronous Area.</p>	
	Legal text comments	
	<p><i>If you believe there are issues in the legal text, can you please bring these to our attention by using the space provided on the response proforma. These will then be discussed at the GC0104 legal text session planned following the closure of this Consultation.</i></p>	UPR has no issues to raise on the proposed legal text.

Grid Code Workgroup Consultation Response Proforma

GC0104 EU Connection Codes GB Implementation – Demand Connection Code

Industry parties are invited to respond to this consultation expressing their views and supplying the rationale for those views, particularly in respect of any specific questions detailed below.

Please send your responses by **5pm** on **29 March 2018** to grid.code@nationalgrid.com. Please note that any responses received after the deadline or sent to a different email address may not receive due consideration by the Workgroup.

Any queries on the content of the consultation should be addressed to Chrissie Brown at Christine.brown1@nationalgrid.com

Respondent:	<i>Graeme Vincent</i> <i>graeme.vincent@spenergynetworks.co.uk</i>
Company Name:	<i>SP Energy Networks</i>
<p>Please express your views regarding the Workgroup Consultation, including rationale.</p> <p>(Please include any issues, suggestions or queries)</p>	<p><i>For reference, the Grid Code objectives are:</i></p> <ul style="list-style-type: none"> i. To permit the development, maintenance and operation of an efficient, coordinated and economical system for the transmission of electricity ii. To facilitate competition in the generation and supply of electricity (and without limiting the foregoing, to facilitate the national electricity transmission system being made available to persons authorised to supply or generate electricity on terms which neither prevent nor restrict competition in the supply or generation of electricity) iii. Subject to sub-paragraphs (i) and (ii), to promote the security and efficiency of the electricity generation, transmission and distribution systems in the national electricity transmission system operator area taken as a whole iv. To efficiently discharge the obligations imposed upon the licensee by this license and to comply with the Electricity Regulation and any relevant legally binding decisions of the European Commission and/or the Agency; and v. To promote efficiency in the implementation and administration of the Grid Code arrangements. <p><i>The Distribution Code objectives are:</i></p> <ul style="list-style-type: none"> i. Permit the development, maintenance, and operation of an efficient, coordinated and economical System for the distribution of electricity. ii. Facilitate competition in the generation and supply of electricity. iii. Efficiently discharge the obligations imposed upon DNOs

	<p>by the Distribution Licence and comply with the Regulation (where Regulation has the meaning defined in the Distribution Licence) and any relevant legally binding decision of the European Commission and/or Agency for the Co-operation of Energy Regulators.</p> <p>iv. Promote efficiency in the implementation and administration of the Distribution Code.</p>
--	---

Standard Workgroup Consultation questions

Q	Question	Response
1	Do you believe that GC0104 Original proposal, or any potential alternatives for change that you wish to suggest, better facilitates the Grid Code Objectives?	As the proposal implements requirements arising from the Demand Connection Code we believe that this better facilitates the objectives.
2	Do you support the proposed implementation approach?	Yes
3	Do you have any other comments?	<p>SPEN believe that the working group has strived to achieve a balance between providing a sufficient level of detail in the Grid and Distribution Codes to ensure that GB can comply with the requirements of the DCC whilst still allowing the emerging DSR practices to develop and innovate appropriately without being constrained by prescriptive hard coded text.</p> <p>Whilst significant effort has been made in relation to definitions, SPEN still have concerns in relation to the interpretation and application of the EU GSP definition. We would support the provision of further clarity in this regard.</p>
4	Do you wish to raise a WG Consultation Alternative Request for the Workgroup to consider?	<i>No but are supportive of a proposed alternative being raised on behalf of the DNOs.</i>

Specific GC0104 questions

Q	Question	Response
5	Do you agree that DNOs should only implement the Demand Response requirements relating to Demand Response Active Power Control and Demand Response Reactive Power Control, recognizing that the	SPEN generally agree with the split of services as identified.

	other DSR services in Article 27 are services for the Transmission System Operator?	
6	Are the rights and obligations of aggregators appropriately allowed for in the drafting of ECC and DPC9? If not, what additional provisions would you suggest?	As the roles of aggregators is very much in its infancy and is still developing, we believe that an appropriate level of detail has been adopted within the drafting.
7	Do you have any comments on the approach taken with the Installation Document pro-forma proposed for Demand Response services contracted to DNOs? Do you agree that there is no distinction necessary here for HV or LV customers?	SPEN have no additional comments and agree that there is no distinction necessary for HV and LV customers.
8	Do you have any views on how to tailor the compliance process, and documentation, to accommodate both individual Demand Response Service Providers and those Demand Response Service Providers who are aggregators?	No
9	Can you see any issues with treating GSPs and EU GSP's in the way set out in the Glossary and Definitions and European Connection Conditions of the solution?	Yes. Further clarity on the application i.e. what constitutes a significant modification and thereby causing a GSP to become an EU GSP would be welcome.
10	Do you agree that the DRSC reflects the requirements of DCC and provides sufficient information for Demand Response Providers. If not, please state why do not believe this to be the case and what you believe would provide a better alternative.	No comment at this time.
11	If you do not believe the proposal sufficiently discharges DCC obligations, can you please provide examples where this is the case?	The proposals contained within this modification sufficiently discharge the DCC obligations.
12	Consultation question specifically for Transmission Licensees As a Transmission Licensee, are there any aspects of this consultation you do not agree	No, from an SPT perspective we have not identified any areas of disagreement, and believe it is appropriate for the relevant TSO to consult with other TSO to ensure a coordinated and consistent approach.

	<p>with from a Transmission Licensees perspective? In particular do you have any comments with regard to DCC Articles 28 and 29 in particular Article 29(2)(d) where there is a requirement for the relevant TSO to consult with TSO's in the Synchronous Area.</p>	
	<p>Legal text comments</p>	
	<p><i>If you believe there are issues in the legal text, can you please bring these to our attention by using the space provided on the response proforma. These will then be discussed at the GC0104 legal text session planned following the closure of this Consultation.</i></p>	

GC0104 EU Connection Codes GB Implementation – Demand Connection Code

Industry parties are invited to respond to this consultation expressing their views and supplying the rationale for those views, particularly in respect of any specific questions detailed below.

Please send your responses by **5pm on 29 March 2018** to grid.code@nationalgrid.com. Please note that any responses received after the deadline or sent to a different email address may not receive due consideration by the Workgroup.

Any queries on the content of the consultation should be addressed to Chrissie Brown at Christine.brown1@nationalgrid.com

Respondent:	<i>Nigel Turvey, 0117 933 2435, nturvey@westernpower.co.uk</i>
Company Name:	<i>Western Power Distribution</i>
Please express your views regarding the Workgroup Consultation, including rationale. (Please include any issues, suggestions or queries)	<i>WPD supports the purpose of the consultation and the general implementation method. Some more specific comments are detailed in the questions below.</i>

Standard Workgroup Consultation questions

Q	Question	Response
1	Do you believe that GC0100 Original proposal, or any potential alternatives for change that you wish to suggest, better facilitates the Grid Code Objectives?	No
2	Do you support the proposed implementation approach?	WPD agrees that the implementation of technical requirements through codes and commercial requirements through contracts is the best of the alternatives.
3	Do you have any other comments?	WPD has concerns over the treatment of significant modifications to GSPs and the additional requirements that could be placed on networks. This concern is enhanced by the apparent difference between the Workgroup consultation document and the proposed legal text. For example Page 13, article 15 of the consultation expresses that if an existing DNO was to significantly modify their GSP (thus becoming an EU GSP) they

		would not be subject to Reactive Power requirements. However ECC 6.4.5 seems to imply the opposite.
4	Do you wish to raise a WG Consultation Alternative Request for the Workgroup to consider?	No

Specific GC0104 questions

Q	Question	Response
5	Do you agree that DNOs should only implement the Demand Response requirements relating to Demand Response Active Power Control and Demand Response Reactive Power Control, recognizing that the other DSR services in Article 27 are services for the Transmission System Operator?	WPD broadly agrees with this distinction. However confusion may arise where a DNO implements a service on the behalf of the Transmission system operator (as will be trialed in the WPD RDP work with National Grid). This is also the case in the Power Potential project.
6	Are the rights and obligations of aggregators appropriately allowed for in the drafting of ECC and DPC9? If not, what additional provisions would you suggest?	The current drafting explicitly allows for participation of aggregators and third parties. If anything the proposal favours third parties over direct customers as they have less onerous requirements in the pro-formas. WPD would encourage equal treatment of aggregators and direct customers.
7	Do you have any comments on the approach taken with the Installation Document pro-forma proposed for Demand Response services contracted to DNOs? Do you agree that there is no distinction necessary here for HV or LV customers?	WPD agrees with the pro-forma approach subject to the comment in Q6. WPD agrees that there is no distinction necessary for HV and LV customers.
8	Do you have any views on how to tailor the compliance process, and documentation, to accommodate both individual Demand Response Service Providers and those Demand Response Service Providers who are aggregators?	As per question 6, WPD would encourage the maximum alignment between compliance and documentation for aggregators or direct customers. For example the current pro-formas require more information on the specific Demand Units for individual customers over aggregators (Technology types, Manufacturers reference number...) Aggregators should be expected to provide the data expected of customers. In addition WPD believes that some of the requirements should be better defined to avoid confusion (for example is the modulated output value

		<p>expected to be the Maximum or Minimum response capacity?).</p> <p>Finally the compliance checks must be reviewed with a view to the practicality of testing required. For example the current DPC9 wording allows significant flexibility for DNOs in terms of the manner in which modulation signals are sent and the response time. By contrast the pro forma requires customers to respond to a non-specific signal within 5 seconds.</p>
9	Can you see any issues with treating GSPs and EU GSP's in the way set out in the Glossary and Definitions and European Connection Conditions of the solution?	No Comment.
10	Do you agree that the DRSC reflects the requirements of DCC and provides sufficient information for Demand Response Providers. If not, please state why do not believe this to be the case and what you believe would provide a better alternative.	No Comment.
11	If you do not believe the proposal sufficiently discharges DCC obligations, can you please provide examples where this is the case?	WPD believes the DCC obligations are discharged.
12	<p>Consultation question specifically for Transmission Licensees</p> <p>As a Transmission Licensee, are there any aspects of this consultation you do not agree with from a Transmission Licensees perspective? In particular do you have any comments with regard to DCC Articles 28 and 29 in particular Article 29(2)(d) where there is a requirement for the relevant TSO to consult with TSO's in the Synchronous Area.</p>	
	Legal text comments	
	<i>If you believe there are issues in the legal text, can you please bring these to our attention by using the space provided on the response proforma. These will then be discussed at the GC0104 legal text session planned following</i>	<p>WPD has identified the following concerns around the legal text of DPC9.</p> <ul style="list-style-type: none"> - The definition of Demand Service Provider include direct customers, however these are then treated as a distinct subset. For example DPC9.1.1and DPC 9.1.2 could be merged.

	<p><i>the closure of this Consultation.</i></p>	<p>This unnecessary distinction is carried throughout the text (9.2.1, 9.2.2....)</p> <ul style="list-style-type: none">- The definition of a Demand Unit may cause confusion for a system made up of components and sub-components. Clarification could be provided on the limits of the definition. For example in a BMS with multiple HVAC units each comprised of fans and pumps, what is a demand unit and what isn't?- Demand units including storage are exempt from DPC9. Further clarification may be required as many systems could be considered to have storage (a HVAC unit may claim to have thermal storage).
--	--	---

GC0104

Workgroup Consultation responses



Workgroup meeting 5 – 4 April 2018

GC 104 Responses (11)

- ENA
- SSE Generation Ltd
- NGET
- RWE
- The ADE
- Flextricity
- SP Generation
- UKPR
- ENWL
- Northern PowerGrid
- SP Energy Networks

Standard Consultation questions

1. Do you believe that GC0104 Original or any potential alternatives for change better facilitate the Grid Code Objectives?

- 9/11 Yes (one stating that new DSR requirements are more confusing – Flextricity)
- 1/11 Not quite depending on how storage is handled (RWE)
- 1/11 No due to the modification being deficient in terms of lack of detail around the technical requirements (SSE)

2. Do you support the implementation approach?

- 9/11 Yes
- 1/11 Broadly ok (RWE)
- 1/11 No – Directive 2015/1535 3 month ahead of implementation submission to the Commission required and technical requirements required in the Grid Code not in BCAs (SSE)

Standard Consultation questions

3. Other comments?

- **SPEN (SP Energy Networks)** The Workgroup have strived to achieve a balance between providing a sufficient level of detail in the Grid and Distribution Codes to ensure that GB can comply with the requirements of the DCC whilst still allowing the emerging DSR practices to develop and innovate appropriately without being constrained by prescriptive hard coded text. Whilst significant effort has been made in relation to definitions, SPEN still have concerns in relation to the interpretation and application of the EU GSP definition. We would support the provision of further clarity in this regard.
- **ENA&Northern PowerGrid** Demand Side Response services are in their infancy. Requirements in GB must do no more than reflect the absolute basics of DCC. Balance appears to have been achieved in the latest drafting.
- **Flextricity** – Confusion will be created in the market if implemented as is. Guidance documentation required to add clarity on what documentation is required
- **RWE** – Storage and how it is being handled when exporting?
- **SSE** - Issues raised around being able to raise an alternative request due to the lack of technical requirements outlined within the Consultation document...

Standard Consultation questions

Comments continued

- **SSE** – Issued also raised around harmonisation. Reference to P362 and Authority delegations.
- **UKPR** – concern around time taken to get the requirements implemented but content that this will be completed in time

Alternative request – Question 4

- One alternative request received from Northern PowerGrid to be discussed this afternoon

Specific GC0104 questions

Q11. If you do not believe the proposal sufficiently discharges DCC obligations, can you please provide examples where this is the case?

- **5/11** No comment
- **5/11** Discharges requirements
- **1/11** Policy approach rather than legal, no technical requirements in mapping (SSE)

Specific GC0104 questions

Q12. Consultation question specifically for Transmission Licensees

As a Transmission Licensee, are there any aspects of this consultation you do not agree with from a Transmission Licensees perspective? In particular do you have any comments with regard to DCC Articles 28 and 29 in particular Article 29(2)(d) where there is a requirement for the relevant TSO to consult with TSO's in the Synchronous Area.

- No, from an SPT perspective we have not identified any areas of disagreement, and believe it is appropriate for the relevant TSO to consult with other TSO to ensure a coordinated and consistent approach
- NGET – completed through Workgroup and Code Administrator Consultation

4 April 2018

Deep dive on:

Alternative request received and **question 9** of Workgroup Consultation:

- *Can you see any issues with treating GSPs and EU GSP's in the way set out in the Glossary and Definitions and European Connection Conditions of the solution?*

Question 10 and DRSC

- *Do you agree that the DRSC reflects the requirements of DCC and provides sufficient information for Demand Response Providers. If not, please state why do not believe this to be the case and what you believe would provide a better alternative.*
- **Start legal text review**

Specific GC0104 questions

Q9. Can you see any issues with treating GSPs and EU GSP's in the way set out in the Glossary and Definitions and European Connection Conditions of the solution?

- **5/11** No comment
- **4/11** Further clarity required/alternative request
- **2/11** Fit for purpose/no issues

Specific GC0104 questions

Q10. Do you agree that the DRSC reflects the requirements of DCC and provides sufficient information for Demand Response Providers. If not, please state why do not believe this to be the case and what you believe would provide a better alternative.

- 1/11 ADE response to be reviewed
- 3/11 No comment
- 5/11 Yes plus one comment around DRSC A.2 - Excess of what is required in DCC? (ENWL)
- 2/11 No – Not enough detail to understand obligations, more documents to read rather than in one place. Obligations in DRSC could be put in STCs to avoid this (Flexricity) No - Ancillary Service agreement Governance an issue and also this modification should be the whole package and is not – does not reflect requirements (SSE)

Alternative request Proposal form

Grid Code

GC0104 –WACM1

Mod Title: As per original (Significant Modification Definition)

Purpose of alternative Proposal:

As per the Original.

Date submitted to Code Administrator: April 2018

You are: A Workgroup member

Workgroup vote outcome: Formal alternative

Contents

1	Alternative proposed solution for workgroup review.....	2
2	Difference between this proposal and Original	2
3	Justification for alternative proposal against Grid Code objectives.....	2
4	Impacts and Other Considerations.....	5
5	Implementation	5
6	Legal Text.....	6

What stage is this document at?

01 Proposed alternative

02 Formal Workgroup alternative



Any Questions?

Contact:

Chrissie Brown

Code Administrator



[christine.brown1](mailto:christine.brown1@nationalgrid.com)

[@nationalgrid.com](mailto:christine.brown1@nationalgrid.com)



01926 65 3328

Alternative Proposer(s):

Alastair Frew

Company



alastair.frew

@scottishpower.com



00000 000 000

1 Alternative proposed solution for workgroup review

During the GC0102 Code Administrators Consultation comments were received suggesting that the proposed definition of **Significant Modification** did not fully represent the legal requirements of the network codes Requirements for Grid Connection of Generators (RfG) EU 2016/631 and Requirements for Grid Connection of High Voltage Direct Current Systems (HVDC) EU 2016/1447. The GC0102 proposal has progressed and is now with the Authority for final determination. This modification proposal GC0104 deals with the Network Code on Demand Connection (DCC) EU 2016/1388 which has the same legal requirements as other two EU network code¹ and whilst initially the Original proposal was to use the same definition of **Significant Modification** as previously set in GC0102 the Original proposal has now been changed to partially match this Alternative proposal, however this is still believed not to cover all requirements. This Alternative proposal will change the definition of **Significant Modification** to be more representative of the legal requirements of the DCC and as a consequence will also improve compliance with the RfG and HVDC requirements.

2 Difference between this proposal and Original

This Alternative proposal will use all the same changes in the original GC0104 proposal except where the Original proposal slightly alters the definition of **Significant Modification** this Alternative proposal will delete the original definition and insert a new definition.

3 Justification for alternative proposal against Grid Code objectives

The application of the DCC connection conditions to existing facilities are dealt with in Article 4 paragraph 1 which states:-

“1.Existing transmission-connected demand facilities, existing transmission-connected distribution facilities, existing distribution systems and existing demand units that are or can be used by a demand facility or a closed distribution system to provide demand response services to a relevant system operator or relevant TSO, are not subject to the requirements of this Regulation, except where:

(a) an existing transmission-connected demand facility, an existing transmission-connected distribution facility, an existing distribution system, or an existing demand unit within a demand facility at a voltage level above 1 000 V or a closed distribution system connected at a voltage level above 1 000 V, has been modified to such an extent that its connection agreement must be substantially revised in accordance with the following procedure:

(i) demand facility owners, DSOs, or CDSOs who intend to undertake the modernisation of a plant or replacement of equipment

¹ Set out in Article 4 of the three respective Regulations.

impacting the technical capabilities of the transmission-connected demand facility, the transmission-connected distribution facility, the distribution system, or the demand unit shall notify their plans to the relevant system operator in advance;

(ii) if the relevant system operator considers that the extent of the modernisation or replacement of equipment is such that a new connection agreement is required, the system operator shall notify the relevant regulatory authority or, where applicable, the Member State; and

(iii) the relevant regulatory authority or, where applicable, the Member State shall decide if the existing connection agreement needs to be revised”

The sections of highlighted yellow text are identical to the wording in the RfG and HVDC codes with only the equipment types being changed, so the rules for modification are to be the same for all equipment types.

The process for dealing with such modifications is currently (as proposed in GC0102) that if an existing installation is determined to be subject to a **Substantial Modification** then the new requirements in the European Connection Conditions shall apply. This Alternative proposal will change this arrangement, by clarifying the definition of **Substantial Modification**, in that the Authority will decide if, and to what extent, the Bilateral Agreement is to be amended (or a new one issued) where a modernisation or replacement of equipment impacts on the technical capability.

The current definition of **Substantial Modification** as proposed in GC0102 is:-

“A **Modification** in relation to modernisation or replacement of the **User’s Main Plant and Apparatus**, which, following notification by the relevant User to NGET, results in substantial amendment to the **Bilateral Agreement** and which need not have a **Material Effect** on **NGET** or a **User**.”

The GC0104 Original modification proposal is changing this definition to:-

“A **Modification** in relation to modernisation or replacement of the **User’s Main Plant and Apparatus** which impacts its technical capabilities, which, following notification by the relevant **User** to **NGET**, results in substantial amendment to the **Bilateral Agreement**.”

Whilst this definition does deal with some aspects of the Network Code requirements it (i) does not limit the applicability to just the modernisation or replacement of equipment and its impact on the technical capability; and (ii) it leaves the key decision making duties to NGET and not the Authority (which the Network Codes explicitly states). Although under current proposed (GC0102/GC0104 Original) arrangements Users, if they disagree with NGET’s application of the **Substantial Modification** rules, can raise a dispute to the Authority for determination, this arrangement is the opposite

too that specified in the Network Codes in that the decision on the application to the User being made by NGET and not the Authority.

The following proposed Alternative definition of **Substantial Modification** makes it clear it is an Authority decision:-

“In relation to any **GB Code User**, any actual or proposed modernisation or replacement of the **User’s Main Plant and Apparatus**, impacting the technical capabilities of the **User’s Main Plant and Apparatus**, which, following notification by the relevant **User** to **NGET**, results in **NGET** requesting, to the **Authority**, that a New **Bilateral Agreement** is required and the **Authority** deciding that either a substantial revision to the existing **Bilateral Agreement** or a new **Bilateral Agreement** is required and which elements of the European Connection Conditions will be applied. ”

For the avoidance of doubt this Alternative proposal does not mean every modification nor Bilateral Agreement change needs to go to the Authority it is only the changes which result in the potential application of the new European Connection Conditions being applied to installations to which, currently, only the existing Connection Conditions apply.

Impact of the modification on the Relevant Objectives:	
Relevant Objective	Identified impact
To permit the development, maintenance and operation of an efficient, coordinated and economical system for the transmission of electricity	Positive
To facilitate competition in the generation and supply of electricity (and without limiting the foregoing, to facilitate the national electricity transmission system being made available to persons authorised to supply or generate electricity on terms which neither prevent nor restrict competition in the supply or generation of electricity)	Positive
Subject to sub-paragraphs (i) and (ii), to promote the security and efficiency of the electricity generation, transmission and distribution systems in the national electricity transmission system operator area taken as a whole	Positive
To efficiently discharge the obligations imposed upon the licensee by this license and to comply with the Electricity Regulation and any relevant legally binding decisions of the European Commission and/or the Agency; and	Positive
To promote efficiency in the implementation and administration of the Grid Code arrangements	Neutral

In broad term the reasons why this Alternative proposal better meet the Applicable Objectives are as per the Original whilst, in addition, also being better in terms of discharging the obligations imposed upon the licensee by this license and to comply with the Electricity Regulation and any relevant legally binding decisions of the European Commission and/or the Agency.

4 Impacts and Other Considerations

As per the Original.

Consumer Impacts

As per the Original.

5 Implementation

As per the Original.

6 Legal Text

As per the Original except for the following definition:-

Existing Definition to be deleted

Substantial Modification	A Modification in relation to modernisation or replacement of the User's Main Plant and Apparatus, which, following notification by the relevant User to NGET, results in substantial amendment to the Bilateral Agreement and which need not have a Material Effect on NGET or a User.
---------------------------------	--

and replaced with the new definition

Substantial Modification	In relation to any GB Code User , any actual or proposed modernisation or replacement of the User's Main Plant and Apparatus , impacting the technical capabilities of the User's Main Plant and Apparatus , which, following notification by the relevant User to NGET , results in NGET requesting, to the Authority , that a New Bilateral Agreement is required and the Authority deciding that either a substantial revision to the existing Bilateral Agreement or a new Bilateral Agreement is required and which elements of the European Connection Conditions will be applied.
---------------------------------	---

Annex 8 Grid Code Legal Text

Please note that the legal text has been drafted on top of modifications GC0100-102 and that these were implemented as the Grid Code baseline on 16 May 2018.

GC0102
GB CONNECTION CONDITIONS LEGAL TEXT
DATED 13/04/18

Key

- 1) Blue Highlighted Text – Taken from GC012 Code Administrator Consultation dated 12/01/2018 - Not relevant for DCC
- 2) Black – Relevant text for GC0104
- 3) Track change marked text – relevant changes for GC0104

CONNECTION CONDITIONS

(CC)

CONTENTS

(This contents page does not form part of the Grid Code)

Paragraph No/Title	Page Number
CC.1 INTRODUCTION	22
AG	
ER	
EF	
□	
To	
c4	
54	
91	
30	
65	
\	
h	
22	

CC.2 OBJECTIVE	22
AG	
ER	
EF	
□	
To	
c4	
54	
91	
30	
66	
\	
h	
22	

Formatted: Highlight

Formatted: Highlight

CC.3 SCOPE22

AG
ER
EF
□
To
c4
54
91
30
67
\
h
22

CC.4 PROCEDURE44

AG
ER
EF
□
To
c4
54
91
30
68
\
h
44

CC.5 CONNECTION44

AG
ER
EF
□
To

c4
54
91
30
69
\
h
44

CC.6 TECHNICAL, DESIGN AND OPERATIONAL CRITERIA 66

AG
ER
EF
\
To
c4
54
91
30
70
\
h
66

CC.7 SITE RELATED CONDITIONS 4644

AG
ER
EF
\
To
c4
54
91
30
71
\
h

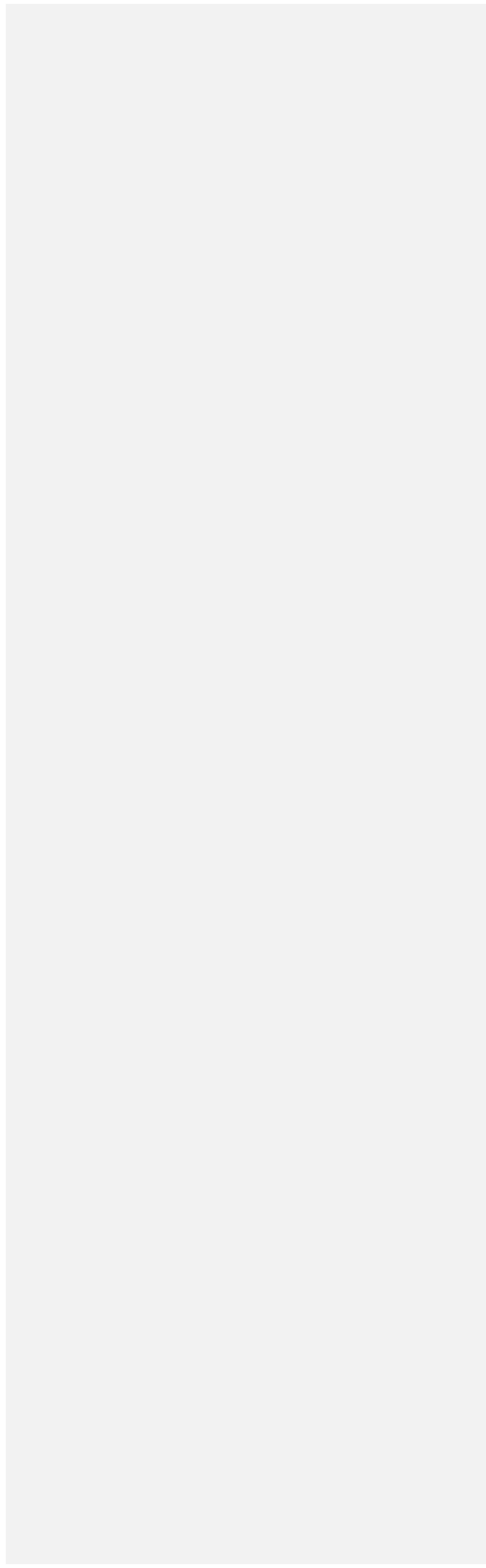

46
44

CC.8 ANCILLARY SERVICES5251

AG
ER
EF
■
To
c4
54
91
30
72
\\
h
52
51

APPENDIX 1 - SITE RESPONSIBILITY SCHEDULES5453

AG
ER
EF
■
To
c4
54
91
30
73
\\
h
54
53

PROFORMA FOR SITE RESPONSIBILITY SCHEDULE 5856

AG
ER
EF
□
To
c4
54
91
30
74
\
h
58
56

APPENDIX 2 - OPERATION DIAGRAMS 6260

AG
ER
EF
□
To
c4
54
91
30
75
\
h
62
60

PART 1A - PROCEDURES RELATING TO OPERATION DIAGRAMS 6260

AG
ER
EF

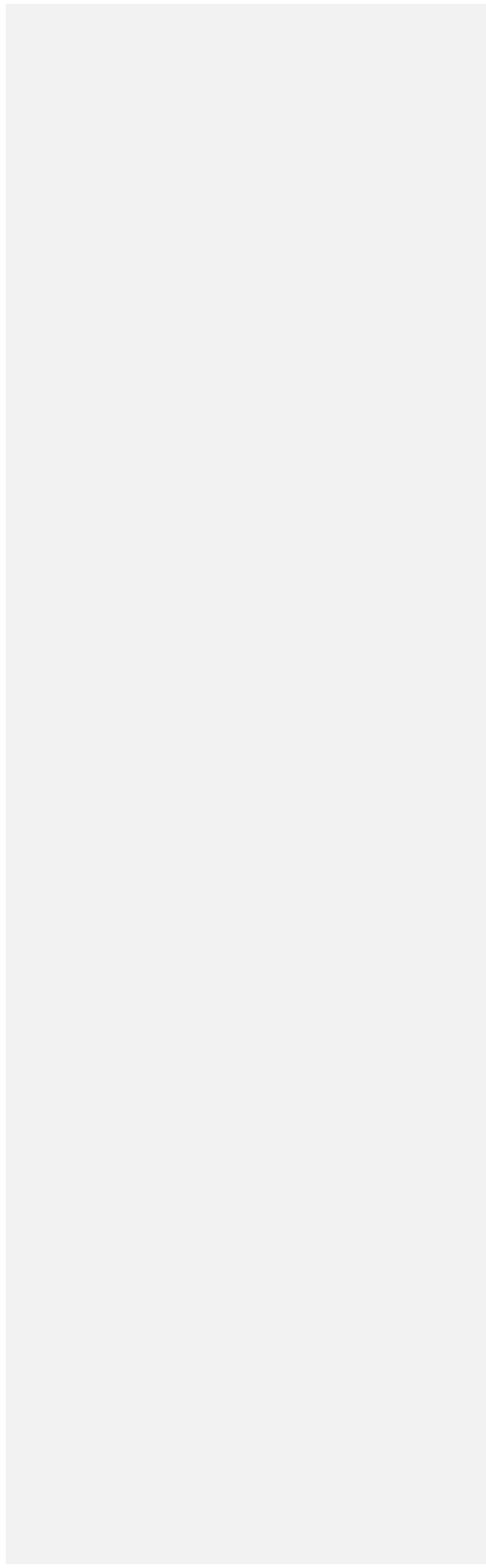

—
To
c4
54
91
30
76
\
h
62
60

PART 1B - PROCEDURES RELATING TO GAS ZONE DIAGRAMS.....6563

AG
ER
EF
—
To
c4
54
91
30
77
\
h
65
63

PART 2 - NON-EXHAUSTIVE LIST OF APPARATUS TO BE INCLUDED ON OPERATION
DIAGRAMS.....6664

AG
ER
EF
—
To
c4
54
91
30
78
\
h

h
66
64

APPENDIX 3 - MINIMUM FREQUENCY RESPONSE REQUIREMENT PROFILE AND OPERATING RANGE FOR NEW POWER STATIONS AND DC CONVERTER STATIONS 6866

AG
ER
EF
L
To
c4
54
91
30
79
V
h
68
66

APPENDIX 4 - FAULT RIDE THROUGH REQUIREMENTS 7374

AG
ER
EF
L
To
c4
54
91
30
80
V
h
73
74

APPENDIX 4A7374

AG
ER
EF
L
To
c4
54
91
30
81
\
h
73
74

APPENDIX 4B7977

AG
ER
EF
L
To
c4
54
91
30
82
\
h
79
77

APPENDIX 5 - TECHNICAL REQUIREMENTS LOW FREQUENCY RELAYS FOR THE AUTOMATIC DISCONNECTION OF SUPPLIES AT LOW FREQUENCY8583

AG
ER

EF
To
c4
54
91
30
83
h
85
83

APPENDIX 6 - PERFORMANCE REQUIREMENTS FOR CONTINUOUSLY ACTING AUTOMATIC EXCITATION CONTROL SYSTEMS FOR ONSHORE SYNCHRONOUS GENERATING UNITS 8785

AG
ER
EF
To
c4
54
91
30
84
h
87
85

APPENDIX 7 - PERFORMANCE REQUIREMENTS FOR CONTINUOUSLY ACTING AUTOMATIC VOLTAGE CONTROL SYSTEMS FOR ONSHORE NON-SYNCHRONOUS GENERATING UNITS, ONSHORE DC CONVERTERS, ONSHORE POWER PARK MODULES AND OTSDUW PLANT AND APPARATUS AT THE INTERFACE POINT 9189

AG
ER
EF
To
c4
54

91
30
85
h
91
89

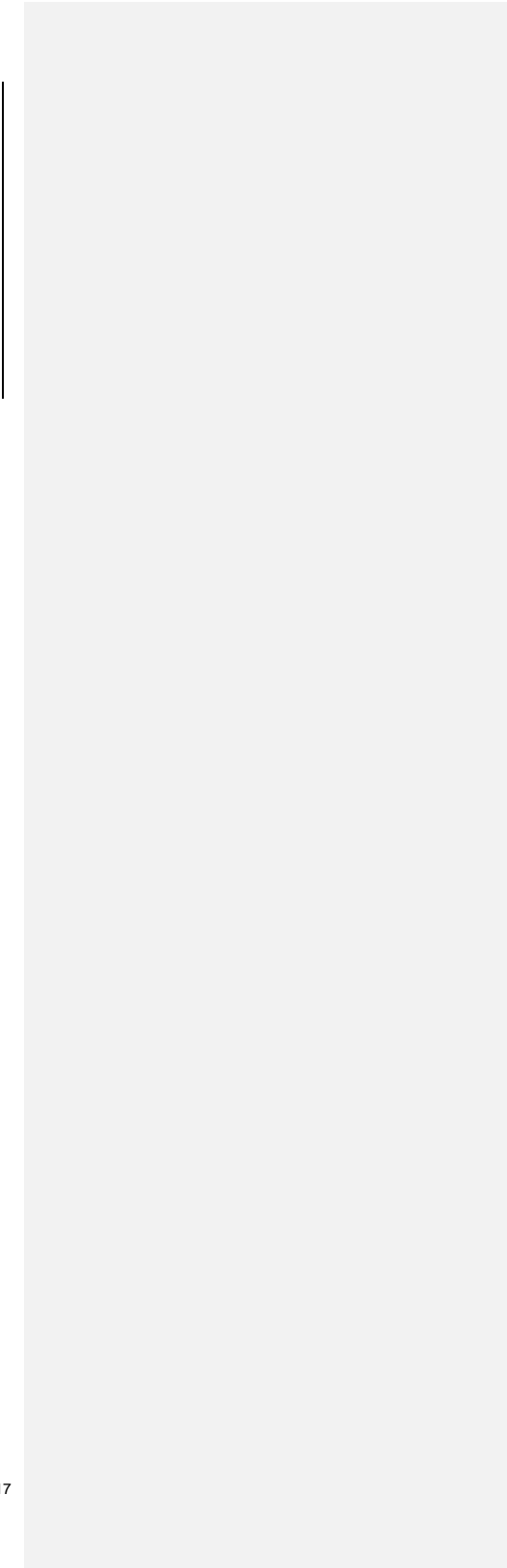

CC.1 INTRODUCTION

CC.1.1 The **Connection Conditions** ("CC") specify both:

- (a) the minimum technical, design and operational criteria which must be complied with by:
 - (i) any **GB Code User** connected to or seeking connection with the **National Electricity Transmission System**, or
 - (ii) **GB Code Users** in respect of **GB Generators** (other than in respect of **Small Power Stations**) or **GB Code User's** in respect of **DC Converter Station** owners connected to or seeking connection to a **User's System** which is located in **Great Britain or Offshore**, and
- (b) the minimum technical, design and operational criteria with which **NGET** will comply in relation to the part of the **National Electricity Transmission System** at the **Connection Site** with **GB Code Users**. In the case of any **OTSDUW Plant and Apparatus**, the **CC** also specify the minimum technical, design and operational criteria which must be complied with by those **GB Code Users** when undertaking **OTSDUW**.
- (c) For the avoidance of doubt, the requirements of these **CC's** do not apply to **EU Code User's** for whom the requirements of the **ECC's** shall apply.

CC.2 OBJECTIVE

CC.2.1 The objective of the **CC** is to ensure that by specifying minimum technical, design and operational criteria the basic rules for connection to the **National Electricity Transmission System** and (for certain **GB Code Users**) to a **User's System** are similar for all **GB Code Users** of an equivalent category and will enable **NGET** to comply with its statutory and **Transmission Licence** obligations.

CC.2.2 In the case of any **OTSDUW** the objective of the **CC** is to ensure that by specifying the minimum technical, design and operational criteria the basic rules relating to an **Offshore Transmission System** designed and constructed by an **Offshore Transmission Licensee** and designed and/or constructed by an **GB Code User** under the **OTSDUW Arrangements** are equivalent.

Formatted: Highlight

CC.2.3 Provisions of the **CC** which apply in relation to **OTSDUW** and **OTSUA**, and/or a **Transmission Interface Site**, shall (in any particular case) apply up to the **OTSUA Transfer Time**, whereupon such provisions shall (without prejudice to any prior non-compliance) cease to apply, without prejudice to the continuing application of provisions of the **CC** applying in relation to the relevant **Offshore Transmission System** and/or **Connection Site**. It is the case therefore that in cases where the **OTSUA** become operational prior to the **OTSUA Transfer Time** that a **GB Generator** is required to comply with this **CC** both as it applies to its **Plant and Apparatus** at a **Connection Site/Connection Point** and the **OTSUA** at the **Transmission Interface Site/Transmission Interface Point** until the **OTSUA Transfer Time** and this **CC** shall be construed accordingly.

Formatted: Highlight

CC.2.4 In relation to **OTSDUW**, provisions otherwise to be contained in a **Bilateral Agreement** may be contained in the **Construction Agreement**, and accordingly a reference in the **CC** to a relevant **Bilateral Agreement** includes the relevant **Construction Agreement**.

Formatted: Highlight

CC.3 SCOPE

CC.3.1 The **CC** applies to **NGET** and to **GB Code Users**, which in the **CC** means:

- (a) **GB Generators** (other than those which only have **Embedded Small Power Stations**), including those undertaking **OTSDUW**;
- (b) **Network Operators**;
- (c) **Non-Embedded Customers**;
- (d) **DC Converter Station owners**; and

Formatted: Highlight

Formatted: Highlight

(e) **BM Participants and Externally Interconnected System Operators** in respect of **CC.6.5 only**.

Formatted: Highlight

CC.3.2 The above categories of **GB Code User** will become bound by the **CC** prior to them generating, distributing, supplying or consuming, as the case may be, and references to the various categories should, therefore, be taken as referring to them in that prospective role as well as to **GB Code Users** actually connected.

CC.3.3 **Embedded Medium Power Stations** not subject to a **Bilateral Agreement** and **Embedded DC Converter Stations** not subject to a **Bilateral Agreement** Provisions.

The following provisions apply in respect of **Embedded Medium Power Stations** not subject to a **Bilateral Agreement** and **Embedded DC Converter Stations** not subject to a **Bilateral Agreement**.

CC.3.3.1 The obligations within the **CC** that are expressed to be applicable to **GB Generators** in respect of **Embedded Medium Power Stations** not subject to a **Bilateral Agreement** and **DC Converter Station** Owners in respect of **Embedded DC Converter Stations** not subject to a **Bilateral Agreement** (where the obligations are in each case listed in CC.3.3.2) shall be read and construed as obligations that the **Network Operator** within whose **System** any such **Medium Power Station** or **DC Converter Station** is **Embedded** must ensure are performed and discharged by the **GB Generator** or the **DC Converter Station** owner. **Embedded Medium Power Stations** not subject to a **Bilateral Agreement** and **Embedded DC Converter Stations** not subject to a **Bilateral Agreement** which are located **Offshore** and which are connected to an **Onshore GB Code Users System** will be required to meet the applicable requirements of the Grid Code as though they are an **Onshore GB Generator** or **Onshore DC Converter Station Owner** connected to an **Onshore User System Entry Point**.

CC.3.3.2 The **Network Operator** within whose **System** a **Medium Power Station** not subject to a **Bilateral Agreement** is **Embedded** or a **DC Converter Station** not subject to a **Bilateral Agreement** is **Embedded** must ensure that the following obligations in the **CC** are performed and discharged by the **GB Generator** in respect of each such **Embedded Medium Power Station** or the **DC Converter Station** owner in the case of an **Embedded DC Converter Station**:

CC.5.1

CC.5.2.2

CC.5.3

CC.6.1.3

CC.6.1.5 (b)

CC.6.3.2, CC.6.3.3, CC.6.3.4, CC.6.3.6, CC.6.3.7, CC.6.3.8, CC.6.3.9, CC.6.3.10, CC.6.3.12, CC.6.3.13, CC.6.3.15, CC.6.3.16

CC.6.4.4

CC.6.5.6 (where required by CC.6.4.4)

In respect of CC.6.2.2.2, CC.6.2.2.3, CC.6.2.2.5, CC.6.1.5(a), CC.6.1.5(b) and CC.6.3.11 equivalent provisions as co-ordinated and agreed with the **Network Operator** and **GB Generator** or **DC Converter Station** owner may be required. Details of any such requirements will be notified to the **Network Operator** in accordance with CC.3.5.

CC.3.3.3 In the case of **Embedded Medium Power Stations** not subject to a **Bilateral Agreement** and **Embedded DC Converter Stations** not subject to a **Bilateral Agreement** the requirements in:

CC.6.1.6

- CC.6.3.8
- CC.6.3.12
- CC.6.3.15
- CC.6.3.16

that would otherwise have been specified in a **Bilateral Agreement** will be notified to the relevant **Network Operator** in writing in accordance with the provisions of the **CUSC** and the **Network Operator** must ensure such requirements are performed and discharged by the **GB Generator** or the **DC Converter Station** owner.

CC.3.4 In the case of **Offshore Embedded Power Stations** connected to an **Offshore GB Code User's System** which directly connects to an **Offshore Transmission System**, any additional requirements in respect of such **Offshore Embedded Power Stations** may be specified in the relevant **Bilateral Agreement** with the **Network Operator** or in any **Bilateral Agreement** between **NGET** and such **Offshore Embedded Power Station**.

CC.3.5 **In the case of a GB Generator undertaking OTSDUW connecting to an Onshore Network Operator's System, any additional requirements in respect of such OTSDUW Plant and Apparatus will be specified in the relevant Bilateral Agreement with the GB Generator. For the avoidance of doubt, requirements applicable to GB Generators undertaking OTSDUW and connecting to a Network Operator's User System, shall be consistent with those applicable requirements of GB Generators undertaking OTSDUW and connecting to a Transmission Interface Point.**

Formatted: Highlight

CC.4 PROCEDURE

CC.4.1 The **CUSC** contains certain provisions relating to the procedure for connection to the **National Electricity Transmission System** or, in the case of **Embedded Power Stations** or **Embedded DC Converter Stations**, becoming operational and includes provisions relating to certain conditions to be complied with by **GB Code Users** prior to and during the course of **NGET** notifying the **GB Code User** that it has the right to become operational. The procedure for a **GB Code User** to become connected is set out in the **Compliance Processes**.

CC.5 CONNECTION

CC.5.1 The provisions relating to connecting to the **National Electricity Transmission System** (or to a **User's System** in the case of a connection of an **Embedded Large Power Station** or **Embedded Medium Power Station** or **Embedded DC Converter Station**) are contained in:

- (a) the **CUSC** and/or **CUSC Contract** (or in the relevant application form or offer for a **CUSC Contract**);
- (b) or, in the case of an **Embedded Development**, the relevant **Distribution Code** and/or the **Embedded Development Agreement** for the connection (or in the relevant application form or offer for an **Embedded Development Agreement**),

and include provisions relating to both the submission of information and reports relating to compliance with the relevant **Connection Conditions** for that **GB Code User**, **Safety Rules**, commissioning programmes, **Operation Diagrams** and approval to connect (and their equivalents in the case of **Embedded Medium Power Stations** not subject to a **Bilateral Agreement** or **Embedded DC Converter Stations** not subject to a **Bilateral Agreement**). References in the **CC** to the "**Bilateral Agreement**" and/or "**Construction Agreement**" and/or "**Embedded Development Agreement**" shall be deemed to include references to the application form or offer therefor.

CC.5.2 **Items For Submission**

Formatted: Highlight

CC.5.2.1 Prior to the **Completion Date** (or, where the **GB Generator** is undertaking **OTSDUW**, any later date specified) under the **Bilateral Agreement** and/or **Construction Agreement**, the following is submitted pursuant to the terms of the **Bilateral Agreement** and/or **Construction Agreement**:

- (a) updated **Planning Code** data (both **Standard Planning Data** and **Detailed Planning Data**), with any estimated values assumed for planning purposes confirmed or, where practical, replaced by validated actual values and by updated estimates for the future and by updated forecasts for **Forecast Data** items such as **Demand**, pursuant to the requirements of the **Planning Code**;
- (b) details of the **Protection** arrangements and settings referred to in CC.6;
- (c) copies of all **Safety Rules** and **Local Safety Instructions** applicable at **Users' Sites** which will be used at the **NGET/User** interface (which, for the purpose of **OC8**, must be to **NGET's** satisfaction regarding the procedures for **Isolation** and **Earthing**. For **User Sites** in Scotland and **Offshore NGET** will consult the **Relevant Transmission Licensee** when determining whether the procedures for **Isolation** and **Earthing** are satisfactory);
- (d) information to enable **NGET** to prepare **Site Responsibility Schedules** on the basis of the provisions set out in Appendix 1;
- (e) an **Operation Diagram** for all **HV Apparatus** on the **User** side of the **Connection Point** as described in CC.7;
- (f) the proposed name of the **User Site** (which shall not be the same as, or confusingly similar to, the name of any **Transmission Site** or of any other **User Site**);
- (g) written confirmation that **Safety Co-ordinators** acting on behalf of the **User** are authorised and competent pursuant to the requirements of **OC8**;
- (h) **RISSP** prefixes pursuant to the requirements of **OC8**. **NGET** is required to circulate prefixes utilising a proforma in accordance with **OC8**;
- (i) a list of the telephone numbers for **Joint System Incidents** at which senior management representatives nominated for the purpose can be contacted and confirmation that they are fully authorised to make binding decisions on behalf of the **User**, pursuant to **OC9**;
- (j) a list of managers who have been duly authorised to sign **Site Responsibility Schedules** on behalf of the **User**;
- (k) information to enable **NGET** to prepare **Site Common Drawings** as described in CC.7;
- (l) a list of the telephone numbers for the **Users** facsimile machines referred to in CC.6.5.9; and
- (m) for **Sites** in Scotland and **Offshore** a list of persons appointed by the **User** to undertake operational duties on the **User's System** (including any **OTSDUW** prior to the **OTSUA Transfer Time**) and to issue and receive operational messages and instructions in relation to the **User's System** (including any **OTSDUW** prior to the **OTSUA Transfer Time**); and an appointed person or persons responsible for the maintenance and testing of **User's Plant** and **Apparatus**.

CC.5.2.2 Prior to the **Completion Date** the following must be submitted to **NGET** by the **Network Operator** in respect of an **Embedded Development**:

- (a) updated **Planning Code** data (both **Standard Planning Data** and **Detailed Planning Data**), with any estimated values assumed for planning purposes confirmed or, where practical, replaced by validated actual values and by updated estimates for the future and by updated forecasts for **Forecast Data** items such as **Demand**, pursuant to the requirements of the **Planning Code**;
- (b) details of the **Protection** arrangements and settings referred to in CC.6;

(c) the proposed name of the **Embedded Medium Power Station** or **Embedded DC Converter Station Site** (which shall be agreed with NGET unless it is the same as, or confusingly similar to, the name of other **Transmission Site** or **User Site**);

CC.5.2.3 Prior to the **Completion Date** contained within an **Offshore Transmission Distribution Connection Agreement** the following must be submitted to **NGET** by the **Network Operator** in respect of a proposed new **Interface Point** within its **User System**:

(a) updated **Planning Code** data (both **Standard Planning Data** and **Detailed Planning Data**), with any estimated values assumed for planning purposes confirmed or, where practical, replaced by validated actual values and by updated estimates for the future and by updated forecasts for **Forecast Data** items such as **Demand**, pursuant to the requirements of the **Planning Code**;

(b) details of the **Protection** arrangements and settings referred to in CC.6;

(c) the proposed name of the **Interface Point** (which shall not be the same as, or confusingly similar to, the name of any **Transmission Site** or of any other **User Site**);

CC.5.2.4 In the case of **OTSDUW Plant and Apparatus** (in addition to items under CC.5.2.1 in respect of the **Connection Site**), prior to the **Completion Date** (or any later date specified) under the **Construction Agreement** the following must be submitted to **NGET** by the **GB Code User** in respect of the proposed new **Connection Point** and **Interface Point**:

(a) updated **Planning Code** data (**Standard Planning Data**, **Detailed Planning Data** and **OTSDUW Data and Information**), with any estimated values assumed for planning purposes confirmed or, where practical, replaced by validated actual values and by updated estimates for the future and by updated forecasts for **Forecast Data** items such as **Demand**, pursuant to the requirements of the **Planning Code**;

(b) details of the **Protection** arrangements and settings referred to in CC.6;

(c) information to enable preparation of the **Site Responsibility Schedules** at the **Transmission Interface Site** on the basis of the provisions set out in Appendix 1.

(d) the proposed name of the **Interface Point** (which shall not be the same as, or confusingly similar to, the name of any **Transmission Site** or of any other **User Site**);

CC.5.3 (a) Of the items CC.5.2.1 (c), (e), (g), (h), (k) and (m) need not be supplied in respect of **Embedded Power Stations** or **Embedded DC Converter Stations**,

(b) item CC.5.2.1(i) need not be supplied in respect of **Embedded Small Power Stations** and **Embedded Medium Power Stations** or **Embedded DC Converter Stations** with a **Registered Capacity** of less than 100MW, and

(c) items CC.5.2.1(d) and (j) are only needed in the case where the **Embedded Power Station** or the **Embedded DC Converter Station** is within a **Connection Site** with another **User**.

CC.5.4 In addition, at the time the information is given under CC.5.2(g), **NGET** will provide written confirmation to the **User** that the **Safety Co-ordinators** acting on behalf of **NGET** are authorised and competent pursuant to the requirements of **OC8**.

CC.6 TECHNICAL, DESIGN AND OPERATIONAL CRITERIA

CC.6.1 National Electricity Transmission System Performance Characteristics

CC.6.1.1 **NGET** shall ensure that, subject as provided in the **Grid Code**, the **National Electricity Transmission System** complies with the following technical, design and operational criteria in relation to the part of the **National Electricity Transmission System** at the **Connection Site** with a **GB Code User** and in the case of **OTSDUW Plant and Apparatus**, a **Transmission Interface Point** (unless otherwise specified in CC.6) although in relation to operational criteria **NGET** may be unable (and will not be required) to comply with this obligation to the extent that there are insufficient **Power Stations** or **User Systems** are not available or **Users** do not comply with **NGET's** instructions or otherwise do not comply with the **Grid Code** and each **GB Code User** shall ensure that its **Plant** and **Apparatus** complies with the criteria set out in CC.6.1.5.

Grid Frequency Variations

CC.6.1.2 The **Frequency** of the **National Electricity Transmission System** shall be nominally 50Hz and shall be controlled within the limits of 49.5 - 50.5Hz unless exceptional circumstances prevail.

CC.6.1.3 The **System Frequency** could rise to 52Hz or fall to 47Hz in exceptional circumstances. Design of **GB Code User's Plant and Apparatus** and **OTSDUW Plant and Apparatus** must enable operation of that **Plant and Apparatus** within that range in accordance with the following:

<u>Frequency Range</u>	<u>Requirement</u>
51.5Hz - 52Hz	Operation for a period of at least 15 minutes is required each time the Frequency is above 51.5Hz.
51Hz - 51.5Hz	Operation for a period of at least 90 minutes is required each time the Frequency is above 51Hz.
49.0Hz - 51Hz	Continuous operation is required
47.5Hz - 49.0Hz	Operation for a period of at least 90 minutes is required each time the Frequency is below 49.0Hz.
47Hz - 47.5Hz	Operation for a period of at least 20 seconds is required each time the Frequency is below 47.5Hz.

For the avoidance of doubt, disconnection, by frequency or speed based relays is not permitted within the frequency range 47.5Hz to 51.5Hz, unless agreed with **NGET** in accordance with CC.6.3.12.

Grid Voltage Variations

CC.6.1.4 Subject as provided below, the voltage on the 400kV part of the **National Electricity Transmission System** at each **Connection Site** with a **GB Code User** (and in the case of **OTSDUW Plant and Apparatus**, a **Transmission Interface Point**) will normally remain within $\pm 5\%$ of the nominal value unless abnormal conditions prevail. The minimum voltage is -10% and the maximum voltage is $+10\%$ unless abnormal conditions prevail, but voltages between $+5\%$ and $+10\%$ will not last longer than 15 minutes unless abnormal conditions prevail. Voltages on the 275kV and 132kV parts of the **National Electricity Transmission System** at each **Connection Site** with a **User** (and in the case of **OTSDUW Plant and Apparatus**, a **Transmission Interface Point**) will normally remain within the limits $\pm 10\%$ of the nominal value unless abnormal conditions prevail. At nominal **System** voltages below 132kV the voltage of the **National Electricity Transmission System** at each **Connection Site** with a **User** (and in the case of **OTSDUW Plant and Apparatus**, a **Transmission Interface Point**) will normally remain within the limits $\pm 6\%$ of the nominal value unless abnormal conditions prevail. Under fault conditions, voltage may collapse transiently to zero at the point of fault until the fault is cleared. The normal operating ranges of the **National Electricity Transmission System** are summarised below:

<u>National Electricity Transmission System</u>	<u>Normal Operating Range</u>
<u>Nominal Voltage</u>	
400kV	400kV $\pm 5\%$
275kV	275kV $\pm 10\%$
132kV	132kV $\pm 10\%$

NGET and a **GB Code User** may agree greater or lesser variations in voltage to those set out above in relation to a particular **Connection Site**, and insofar as a greater or lesser variation is agreed, the relevant figure set out above shall, in relation to that **GB Code User** at the particular **Connection Site**, be replaced by the figure agreed.

Voltage Waveform Quality

CC.6.1.5 All **Plant** and **Apparatus** connected to the **National Electricity Transmission System**, and that part of the **National Electricity Transmission System** at each **Connection Site** or, in the case of **OTSDUW Plant and Apparatus**, at each **Interface Point**, should be capable of withstanding the following distortions of the voltage waveform in respect of harmonic content and phase unbalance:

(a) Harmonic Content

The **Electromagnetic Compatibility Levels** for harmonic distortion on the **Onshore Transmission System** from all sources under both **Planned Outage** and fault outage conditions, (unless abnormal conditions prevail) shall comply with the levels shown in the tables of Appendix A of **Engineering Recommendation G5/4**. The **Electromagnetic Compatibility Levels** for harmonic distortion on an **Offshore Transmission System** will be defined in relevant **Bilateral Agreements**.

Engineering Recommendation G5/4 contains planning criteria which **NGET** will apply to the connection of non-linear **Load** to the **National Electricity Transmission System**, which may result in harmonic emission limits being specified for these **Loads** in the relevant **Bilateral Agreement**. The application of the planning criteria will take into account the position of ~~existing and prospective~~ **GB Code** and **EU Code Users' Plant and Apparatus** (and **OTSDUW Plant and Apparatus**) in relation to harmonic emissions. **GB Code Users** must ensure that connection of distorting loads to their **User Systems** do not cause any harmonic emission limits specified in the **Bilateral Agreement**, or where no such limits are specified, the relevant planning levels specified in **Engineering Recommendation G5/4** to be exceeded.

(b) Phase Unbalance

Under **Planned Outage** conditions, the weekly 95 percentile of **Phase (Voltage) Unbalance**, calculated in accordance with IEC 61000-4-30 and IEC 61000-3-13, on the **National Electricity Transmission System** for voltages above 150kV should remain, in England and Wales, below 1.5%, and in Scotland, below 2%, and for voltages of 150kV and below, across GB below 2%, unless abnormal conditions prevail and **Offshore** (or in the case of **OTSDUW, OTSDUW Plant and Apparatus**) will be defined in relevant **Bilateral Agreements**.

The Phase Unbalance is calculated from the ratio of root mean square (rms) of negative phase sequence voltage to rms of positive phase sequence voltage, based on 10-minute average values, in accordance with IEC 61000-4-30.

CC.6.1.6 Across GB, under the **Planned Outage** conditions stated in CC.6.1.5(b) infrequent short duration peaks with a maximum value of 2% are permitted for **Phase (Voltage) Unbalance**, for voltages above 150kV, subject to the prior agreement of **NGET** under the **Bilateral Agreement** and in relation to **OTSDUW**, the **Construction Agreement**. **NGET** will only agree following a specific assessment of the impact of these levels on **Transmission Apparatus** and other **Users Apparatus** with which it is satisfied.

Voltage Fluctuations

CC.6.1.7 Voltage changes at a **Point of Common Coupling** on the **Onshore Transmission System** shall not exceed:

(a) The limits specified in Table CC.6.1.7 with the stated frequency of occurrence, where:

$$\% \Delta V_{\text{steadystate}} = \left| 100 \times \frac{\Delta V_{\text{steadystate}}}{V_0} \right| \quad (i)$$

and

$$\% \Delta V_{\text{max}} = 100 \times \frac{\Delta V_{\text{max}}}{V_0} ;$$

- (ii) V_0 is the initial steady state system voltage;
- (iii) $V_{\text{steadystate}}$ is the system voltage reached when the rate of change of system voltage over time is less than or equal to 0.5% over 1 second and $\Delta V_{\text{steadystate}}$ is the absolute value of the difference between $V_{\text{steadystate}}$ and V_0 ;
- (iv) ΔV_{max} is the absolute value of the maximum change in the system voltage relative to the initial steady state system voltage of V_0 ;
- (v) All voltages are the root mean square of the voltage measured over one cycle refreshed every half a cycle as per IEC 61000-4-30;
- (vi) The voltage changes specified are the absolute maximum allowed, applied to phase to ground or phase to phase voltages whichever is the highest change;
- (vii) Voltage changes in category 3 do not exceed the limits depicted in the time dependant characteristic shown in Figure CC.6.1.7;
- (viii) Voltage changes in category 3 only occur infrequently, typically not planned more than once per year on average over the lifetime of a connection, and in circumstances notified to **NGET**, such as for example commissioning in accordance with a commissioning programme, implementation of a planned outage notified in accordance with **OC2** or an **Operation** or **Event** notified in accordance with **OC7**; and
- (ix) For connections with a **Completion Date** after 1st September 2015 and where voltage changes would constitute a risk to the **National Electricity Transmission System** or, in **NGET**'s view, the **System** of any **GB Code User**, **Bilateral Agreements** may include provision for **NGET** to reasonably limit the number of voltage changes in category 2 or 3 to a lower number than specified in Table CC.6.1.7 to ensure that the total number of voltage changes at the **Point of Common Coupling** across multiple **Users** remains within the limits of Table CC.6.1.7.

Category	Maximum number of Occurrences	$\% \Delta V_{\text{max}}$ & $\% \Delta V_{\text{steadystate}}$
1	No Limit	$ \% \Delta V_{\text{max}} \leq 1\%$ & $ \% \Delta V_{\text{steadystate}} \leq 1\%$
2	$\frac{3600}{0.304 \sqrt{2.5 \times \% \Delta V_{\text{max}}}}$ occurrences per hour with events evenly distributed	$1\% < \% \Delta V_{\text{max}} \leq 3\%$ & $ \% \Delta V_{\text{steadystate}} \leq 3\%$
3	No more than 4 per day for Commissioning, Maintenance and Fault Restoration	For decreases in voltage: $\% \Delta V_{\text{max}} \leq 12\%^1$ & $\% \Delta V_{\text{steadystate}} \leq 3\%$ For increases in voltage: $\% \Delta V_{\text{max}} \leq 5\%^2$ & $\% \Delta V_{\text{steadystate}} \leq 3\%$ (see Figure CC6.1.7)

Table CC.6.1.7 - Limits for Rapid Voltage Changes

- ¹ A decrease in voltage of up to 12% is permissible for up to 80ms, as highlighted in the shaded area in Figure CC.6.1.7, reducing to up to 10% after 80ms and to up to 3% after 2 seconds.
- ² An increase in voltage of up to 5% is permissible if it is reduced to up to 3% after 0.5 seconds.

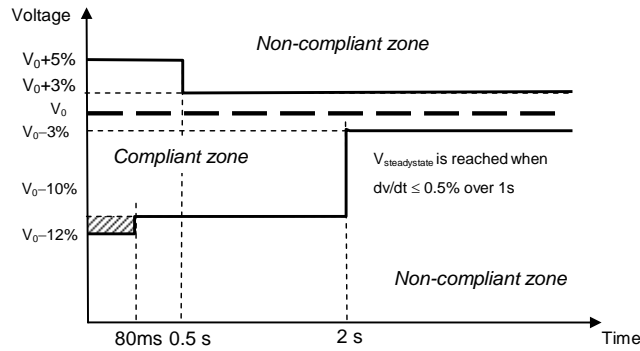

Figure CC.6.1.7 -
Time and magnitude limits for a category 3 Rapid Voltage Change

- (b) For voltages above 132kV, **Flicker Severity (Short Term)** of 0.8 Unit and a **Flicker Severity (Long Term)** of 0.6 Unit, for voltages 132kV and below, **Flicker Severity (Short Term)** of 1.0 Unit and a **Flicker Severity (Long Term)** of 0.8 Unit, as set out in **Engineering Recommendation P28** as current at the **Transfer Date**.

CC.6.1.8 Voltage fluctuations at a **Point of Common Coupling** with a fluctuating **Load** directly connected to an **Offshore Transmission System** (or in the case of **OTSDUW, OTSDUW Plant and Apparatus**) shall not exceed the limits set out in the **Bilateral Agreement**.

Sub-Synchronous Resonance and Sub-Synchronous Torsional Interaction

CC.6.1.9 **NGET shall ensure that GB Code Users' Plant and Apparatus will not be subject to unacceptable Sub-Synchronous Oscillation conditions as specified in the relevant Licence Standards.**

CC.6.1.10 **NGET shall ensure where necessary, and in consultation with Transmission Licensees where required, that any relevant site specific conditions applicable at a GB Code User's Connection Site, including a description of the Sub-Synchronous Oscillation conditions considered in the application of the relevant Licence Standards, are set out in the GB Code User's Bilateral Agreement.**

Formatted: Highlight

CC.6.2 Plant and Apparatus relating to Connection Site and Interface Point

The following requirements apply to **Plant** and **Apparatus** relating to the **Connection Point**, and **OTSDUW Plant and Apparatus** relating to the **Interface Point** (until the **OTSUA Transfer Time**) and **Connection Point** which (except as otherwise provided in the relevant paragraph) each **GB Code User** must ensure are complied with in relation to its **Plant** and **Apparatus** and which in the case of CC.6.2.2.2.2, CC.6.2.3.1.1 and CC.6.2.1.1(b) only, **NGET** must ensure are complied with in relation to **Transmission Plant and Apparatus**, as provided in those paragraphs.

CC.6.2.1 General Requirements

CC.6.2.1.1 (a) The design of connections between the **National Electricity Transmission System** and:

(i) any **Generating Unit** (other than a **CCGT Unit** or **Power Park Unit**) **DC Converter, Power Park Module** or **CCGT Module**, or

(ii) any **Network Operator's System**, or

(iii) **Non-Embedded Customers** equipment;

will be consistent with the **Licence Standards**.

In the case of **OTSDUW**, the design of the **OTSUA's** connections at the **Interface Point** and **Connection Point** will be consistent with **Licence Standards**.

(b) The **National Electricity Transmission System** (and any **OTSDUW Plant and Apparatus**) at nominal **System** voltages of 132kV and above is/shall be designed to be earthed with an **Earth Fault Factor** of, in England and Wales or **Offshore**, below 1.4 and in Scotland, below 1.5. Under fault conditions the rated **Frequency** component of voltage could fall transiently to zero on one or more phases or, in England and Wales, rise to 140% phase-to-earth voltage, or in Scotland, rise to 150% phase-to-earth voltage. The voltage rise would last only for the time that the fault conditions exist. The fault conditions referred to here are those existing when the type of fault is single or two phase-to-earth.

(c) For connections to the **National Electricity Transmission System** at nominal **System** voltages of below 132kV the earthing requirements and voltage rise conditions will be advised by **NGET** as soon as practicable prior to connection and in the case of **OTSDUW Plant and Apparatus** shall be advised to **NGET** by the **GB Code User**.

CC.6.2.1.2 Substation Plant and Apparatus

(a) The following provisions shall apply to all **Plant** and **Apparatus** which is connected at the voltage of the **Connection Point** (and **OTSDUW Plant and Apparatus** at the **Interface Point**) and which is contained in equipment bays that are within the **Transmission** busbar **Protection** zone at the **Connection Point**. This includes circuit breakers, switch disconnectors, disconnectors, **Earthing Devices**, power transformers, voltage transformers, reactors, current transformers, surge arresters, bushings, neutral equipment, capacitors, line traps, coupling devices, external insulation and insulation co-ordination devices. Where necessary, this is as more precisely defined in the **Bilateral Agreement**.

(i) Plant and/or Apparatus prior to 1st January 1999

Each item of such **Plant** and/or **Apparatus** which at 1st January 1999 is either :

installed; or

owned (but is either in storage, maintenance or awaiting installation); or

ordered;

and is the subject of a **Bilateral Agreement** with regard to the purpose for which it is in use or intended to be in use, shall comply with the relevant

standards/specifications applicable at the time that the **Plant** and/or **Apparatus** was designed (rather than commissioned) and any further requirements as specified in the **Bilateral Agreement**.

- (ii) Plant and/or Apparatus post 1st January 1999 for a new Connection Point (including OTSDUW Plant and Apparatus at the Interface Point)

Each item of such **Plant** and/or **Apparatus** installed in relation to a new **Connection Point** (or **OTSDUW Plant and Apparatus** at the **Interface Point**) after 1st January 1999 shall comply with the relevant **Technical Specifications** and any further requirements identified by **NGET**, acting reasonably, to reflect the options to be followed within the **Technical Specifications** and/or to complement if necessary the **Technical Specifications** so as to enable **NGET** to comply with its obligations in relation to the **National Electricity Transmission System** or, in Scotland or **Offshore**, the **Relevant Transmission Licensee** to comply with its obligations in relation to its **Transmission System**. This information, including the application dates of the relevant **Technical Specifications**, will be as specified in the **Bilateral Agreement**.

- (iii) New Plant and/or Apparatus post 1st January 1999 for an existing Connection Point (including OTSDUW Plant and Apparatus at the Interface Point)

Each new additional and/or replacement item of such **Plant** and/or **Apparatus** installed in relation to a change to an existing **Connection Point** (or **OTSDUW Plant and Apparatus** at the **Interface Point** and **Connection Point**) after 1st January 1999 shall comply with the standards/specifications applicable when the change was designed, or such other standards/specifications as necessary to ensure that the item of **Plant** and/or **Apparatus** is reasonably fit for its intended purpose having due regard to the obligations of **NGET**, the relevant **GB Code User** and, in Scotland, or **Offshore**, also the **Relevant Transmission Licensee** under their respective **Licences**. Where appropriate this information, including the application dates of the relevant standards/specifications, will be as specified in the varied **Bilateral Agreement**.

- (iv) Used Plant and/or Apparatus being moved, re-used or modified

If, after its installation, any such item of **Plant** and/or **Apparatus** is subsequently:

- moved to a new location; or
- used for a different purpose; or
- otherwise modified;

then the standards/specifications as described in (i), (ii), or (iii) above or in ECC.6.2.1.2 (as applicable) will apply as appropriate to such **Plant** and/or **Apparatus**, which must be reasonably fit for its intended purpose having due regard to the obligations of **NGET**, the relevant **GB Code User** or **EU Code User** (as applicable) and, in Scotland or **Offshore**, also the **Relevant Transmission Licensee** under their respective **Licences**.

- (b) **NGET** shall at all times maintain a list of those **Technical Specifications** and additional requirements which might be applicable under this CC.6.2.1.2 and which may be referenced by **NGET** in the **Bilateral Agreement**. **NGET** shall provide a copy of the list upon request to any **User**.
- (c) Where the **GB Code User** provides **NGET** with information and/or test reports in respect of **Plant** and/or **Apparatus** which the **GB Code User** reasonably believes demonstrate the compliance of such items with the provisions of a **Technical Specification** then **NGET** shall promptly and without unreasonable delay give due and proper consideration to such information.

- (d) **Plant** and **Apparatus** shall be designed, manufactured and tested in premises with an accredited certificate in accordance with the quality assurance requirements of the relevant standard in the BS EN ISO 9000 series (or equivalent as reasonably approved by **NGET**) or in respect of test premises which do not include a manufacturing facility premises with an accredited certificate in accordance with BS EN 45001.
- (e) Each connection between an **GB Code User** and the **National Electricity Transmission System** must be controlled by a circuit-breaker (or circuit breakers) capable of interrupting the maximum short circuit current at the point of connection. The **Seven Year Statement** gives values of short circuit current and the rating of **Transmission** circuit breakers at existing and committed **Connection Points** for future years.
- (f) Each connection between a **GB Generator** undertaking **OTSDUW** or an **Onshore Transmission Licensee**, must be controlled by a circuit breaker (or circuit breakers) capable of interrupting the maximum short circuit current at the **Transmission Interface Point**. The **Seven Year Statement** gives values of short circuit current and the rating of **Transmission** circuit breakers at existing and committed **Transmission Interface Points** for future years.

CC.6.2.2 Requirements at Connection Points or, in the case of OTSDUW at Interface Points that relate to GB Generators or OTSDUW Plant and Apparatus or DC Converter Station owners

Formatted: Highlight

CC.6.2.2.1 Not Used.

CC.6.2.2.2 Generating Unit, OTSDUW Plant and Apparatus and Power Station Protection Arrangements

CC.6.2.2.2.1 Minimum Requirements

Protection of Generating Units (other than Power Park Units), DC Converters, OTSDUW Plant and Apparatus or Power Park Modules and their connections to the **National Electricity Transmission System** shall meet the requirements given below. These are necessary to reduce the impact on the **National Electricity Transmission System** of faults on **OTSDUW Plant and Apparatus** circuits or circuits owned by **GB Generators** or **DC Converter Station** owners.

CC.6.2.2.2.2 Fault Clearance Times

(a) The required fault clearance time for faults on the **GB Generator's** or **DC Converter Station** owner's equipment directly connected to the **National Electricity Transmission System** or **OTSDUW Plant and Apparatus** and for faults on the **National Electricity Transmission System** directly connected to the **GB Generator** or **DC Converter Station** owner's equipment or **OTSDUW Plant and Apparatus**, from fault inception to the circuit breaker arc extinction, shall be set out in the **Bilateral Agreement**. The fault clearance time specified in the **Bilateral Agreement** shall not be shorter than the durations specified below:

(i) 80ms at 400kV

(ii) 100ms at 275kV

(iii) 120ms at 132kV and below

but this shall not prevent the **GB Code User** or **NGET** or the **GB Generator** (including in respect of **OTSDUW Plant and Apparatus**) from selecting a shorter fault clearance time on their own **Plant and Apparatus** provided **Discrimination** is achieved.

A longer fault clearance time may be specified in the **Bilateral Agreement** for faults on the **National Electricity Transmission System**. A longer fault clearance time for faults on the **GB Generator** or **DC Converter Station** owner's equipment or **OTSDUW Plant and Apparatus** may be agreed with **NGET** in accordance with the terms of the **Bilateral Agreement** but only if **System** requirements, in **NGET's** view, permit. The probability that the fault clearance time stated in the **Bilateral Agreement** will be exceeded by any given fault, must be less than 2%.

(b) In the event that the required fault clearance time is not met as a result of failure to operate on the **Main Protection System(s)** provided, the **GB Generators** or **DC Converter Station** owners or **GB Generators** in the case of **OTSDUW Plant and Apparatus** shall, except as specified below provide **Independent Back-Up Protection**. **NGET** will also provide **Back-Up Protection** and **NGET** and the **GB Code User's Back-Up Protections** will be co-ordinated so as to provide **Discrimination**.

On a **Generating Unit** (other than a **Power Park Unit**), **DC Converter** or **Power Park Module** or **OTSDUW Plant and Apparatus** in respect of which the **Completion Date** is after 20 January 2016 and connected to the **National Electricity Transmission System** at 400kV or 275kV and where two **Independent Main Protections** are provided to clear faults on the **HV Connections** within the required fault clearance time, the **Back-Up Protection** provided by **GB Generators** (including in respect of **OTSDUW Plant and Apparatus**) and **DC Converter Station** owner shall operate to give a fault clearance time of no longer than 300ms at the minimum infeed for normal operation for faults on the **HV Connections**. Where two **Independent Main Protections** are installed the **Back-Up Protection** may be integrated into one (or both) of the **Independent Main Protection** relays.

On a **Generating Unit** (other than a **Power Park Unit**), **DC Converter** or **Power Park Module** or **OTSDUW Plant and Apparatus** in respect of which the **Completion Date** is after 20 January 2016 and connected to the **National Electricity Transmission System** at 132 kV and where only one **Main Protection** is provided to clear faults on the **HV Connections** within the required fault clearance time, the **Independent Back-Up Protection** provided by the **GB Generator** (including in respect of **OTSDUW Plant and Apparatus**) and the **DC Converter Station** owner shall operate to give a fault clearance time of no longer than 300ms at the minimum infeed for normal operation for faults on the **HV Connections**.

On a **Generating Unit** (other than a **Power Park Unit**), **DC Converter** or **Power Park Module** or **OTSDUW Plant and Apparatus** connected to the **National Electricity Transmission System** and on **Generating Units** (other than a **Power Park Unit**), **DC Converters** or **Power Park Modules** or **OTSDUW Plant and Apparatus** connected to the **National Electricity Transmission System** at 400 kV or 275 kV or 132 kV, in respect of which the **Completion Date** is before the 20 January 2016, the **Back-Up Protection** or **Independent Back-Up Protection** shall operate to give a fault clearance time of no longer than 800ms in England and Wales or 300ms in Scotland at the minimum infeed for normal operation for faults on the **HV Connections**.

A **Generating Unit** (other than a **Power Park Unit**), **DC Converter** or **Power Park Module** or **OTSDUW Plant and Apparatus** with **Back-Up Protection** or **Independent Back-Up Protection** will also be required to withstand, without tripping, the loading incurred during the clearance of a fault on the **National Electricity Transmission System** by breaker fail **Protection** at 400kV or 275kV or of a fault cleared by **Back-Up Protection** where the **GB Generator** (including in the case of **OTSDUW Plant and Apparatus**) or **DC Converter** is connected at 132kV and below. This will permit **Discrimination** between **GB Generator** in respect of **OTSDUW Plant and Apparatus** or **DC Converter Station** owners' **Back-Up Protection** or **Independent Back-Up Protection** and the **Back-Up Protection** provided on the **National Electricity Transmission System** and other **Users' Systems**.

(c) When the **Generating Unit** (other than **Power Park Units**), or the **DC Converter** or **Power Park Module** or **OTSDUW Plant and Apparatus** is connected to the **National Electricity Transmission System** at 400kV or 275kV, and in Scotland and **Offshore** also at 132kV, and a circuit breaker is provided by the **GB Generator** (including in respect of **OTSDUW Plant and Apparatus**) or the **DC Converter Station** owner, or **NGET**, as the case may be, to interrupt fault current interchange with the **National Electricity Transmission System**, or **GB Generator's System**, or **DC Converter Station** owner's **System**, as the case may be, circuit breaker fail **Protection** shall be provided by the **GB Generator** (including in respect of **OTSDUW Plant and Apparatus**) or **DC Converter Station** owner, or **NGET**, as the case may be, on this circuit breaker. In the event, following operation of a **Protection** system, of a failure to interrupt fault current by these circuit-breakers within the **Fault Current Interruption Time**, the circuit breaker fail **Protection** is required to initiate tripping of all the necessary electrically adjacent circuit-breakers so as to interrupt the fault current within the next 200ms.

(d) The target performance for the **System Fault Dependability Index** shall be not less than 99%. This is a measure of the ability of **Protection** to initiate successful tripping of circuit breakers which are associated with the faulty item of **Apparatus**.

CC.6.2.2.3 **Equipment to be provided**

CC.6.2.2.3.1 **Protection of Interconnecting Connections**

The requirements for the provision of **Protection** equipment for interconnecting connections will be specified in the **Bilateral Agreement**. In this **CC** the term "interconnecting connections" means the primary conductors from the current transformer accommodation on the circuit side of the circuit breaker to the **Connection Point** or the primary conductors from the current transformer accommodation on the circuit side of the **OTSDUW Plant and Apparatus** of the circuit breaker to the **Transmission Interface Point**.

CC.6.2.2.3.2 **Circuit-breaker fail Protection**

The **GB Generator** or **DC Converter Station** owner will install circuit breaker fail **Protection** equipment in accordance with the requirements of the **Bilateral Agreement**. The **GB Generator** or **DC Converter Station** owner will also provide a back-trip signal in the event of loss of air from its pressurised head circuit breakers, during the **Generating Unit** (other than a **CCGT Unit** or **Power Park Unit**) or **CCGT Module** or **DC Converter** or **Power Park Module** run-up sequence, where these circuit breakers are installed.

CC.6.2.2.3.3 **Loss of Excitation**

The **GB Generator** must provide **Protection** to detect loss of excitation on a **Generating Unit** and initiate a **Generating Unit** trip.

CC.6.2.2.3.4 **Pole-Slipping Protection**

Where, in **NGET's** reasonable opinion, **System** requirements dictate, **NGET** will specify in the **Bilateral Agreement** a requirement for **GB Generators** to fit pole-slipping **Protection** on their **Generating Units**.

CC.6.2.2.3.5 **Signals for Tariff Metering**

GB Generators and **DC Converter Station** owners will install current and voltage transformers supplying all tariff meters at a voltage to be specified in, and in accordance with, the **Bilateral Agreement**.

CC.6.2.2.4 **Work on Protection Equipment**

No busbar **Protection**, mesh corner **Protection**, circuit-breaker fail **Protection** relays, AC or DC wiring (other than power supplies or DC tripping associated with the **Generating Unit**, **DC Converter** or **Power Park Module** itself) may be worked upon or altered by the **GB Generator** or **DC Converter Station** owner personnel in the absence of a representative of **NGET** or in Scotland or **Offshore**, a representative of **NGET**, or written authority from **NGET** to perform such work or alterations in the absence of a representative of **NGET**.

CC.6.2.2.5 Relay Settings

Protection and relay settings will be co-ordinated (both on connection and subsequently) across the **Connection Point** in accordance with the **Bilateral Agreement** and in relation to **OTSDUW Plant and Apparatus**, across the **Interface Point** in accordance with the **Bilateral Agreement** to ensure effective disconnection of faulty **Apparatus**.

CC.6.2.3 Requirements at Connection Points relating to Network Operators and Non-Embedded Customers

CC.6.2.3.1 Protection Arrangements for Network Operators and Non-Embedded Customers

CC.6.2.3.1.1 **Protection of Network Operator and Non-Embedded Customers Systems** directly connected to the **National Electricity Transmission System**, shall meet the requirements given below:

Fault Clearance Times

(a) The required fault clearance time for faults on **Network Operator** and **Non-Embedded Customer** equipment directly connected to the **National Electricity Transmission System**, and for faults on the **National Electricity Transmission System** directly connected to the **Network Operator's** or **Non-Embedded Customer's** equipment, from fault inception to the circuit breaker arc extinction, shall be set out in each **Bilateral Agreement**. The fault clearance time specified in the **Bilateral Agreement** shall not be shorter than the durations specified below:

- (i) 80ms at 400kV
- (ii) 100ms at 275kV
- (iii) 120ms at 132kV and below

but this shall not prevent the **GB Code User** or **NGET** from selecting a shorter fault clearance time on its own **Plant** and **Apparatus** provided **Discrimination** is achieved.

For the purpose of establishing the **Protection** requirements in accordance with CC.6.2.3.1.1 only, the point of connection of the **Network Operator** or **Non-Embedded Customer** equipment to the **National Electricity Transmission System** shall be deemed to be the low voltage busbars at a **GB Grid Supply Point**, irrespective of the ownership of the equipment at the **GB Grid Supply Point**.

A longer fault clearance time may be specified in the **Bilateral Agreement** for faults on the **National Electricity Transmission System**. A longer fault clearance time for faults on the **Network Operator** and **Non-Embedded Customers** equipment may be agreed with **NGET** in accordance with the terms of the **Bilateral Agreement** but only if **System** requirements in **NGET's** view permit. The probability that the fault clearance time stated in the **Bilateral Agreement** will be exceeded by any given fault must be less than 2%.

- (b) (i) For the event of failure of the **Protection** systems provided to meet the above fault clearance time requirements, **Back-Up Protection** shall be provided by the **Network Operator** or **Non-Embedded Customer** as the case may be.
- (ii) **NGET** will also provide **Back-Up Protection**, which will result in a fault clearance time longer than that specified for the **Network Operator** or **Non-Embedded Customer Back-Up Protection** so as to provide **Discrimination**.
- (iii) For connections with the **National Electricity Transmission System** at 132kV and below, it is normally required that the **Back-Up Protection** on the **National Electricity Transmission System** shall discriminate with the **Network Operator** or **Non-Embedded Customer's Back-Up Protection**.
- (iv) For connections with the **National Electricity Transmission System** at 400kV or 275kV, the **Back-Up Protection** will be provided by the **Network Operator** or **Non-Embedded Customer**, as the case may be, with a fault clearance time not longer than 300ms for faults on the **Network Operator's** or **Non-Embedded**

Formatted: Font: Bold

Formatted: Font: Bold

Customer's Apparatus.

- (v) Such **Protection** will also be required to withstand, without tripping, the loading incurred during the clearance of a fault on the **National Electricity Transmission System** by breaker fail **Protection** at 400kV or 275kV. This will permit **Discrimination** between **Network Operator's Back-Up Protection** or **Non-Embedded Customer's Back-Up Protection**, as the case may be, and **Back-Up Protection** provided on the **National Electricity Transmission System** and other **User Systems**. The requirement for and level of **Discrimination** required will be specified in the **Bilateral Agreement**.
- (c) (i) Where the **Network Operator** or **Non-Embedded Customer** is connected to the **National Electricity Transmission System** at 400kV or 275kV, and in Scotland also at 132kV, and a circuit breaker is provided by the **Network Operator** or **Non-Embedded Customer**, or **NGET**, as the case may be, to interrupt the interchange of fault current with the **National Electricity Transmission System** or the **System** of the **Network Operator** or **Non-Embedded Customer**, as the case may be, circuit breaker fail **Protection** will be provided by the **Network Operator** or **Non-Embedded Customer**, or **NGET**, as the case may be, on this circuit breaker.
 - (ii) In the event, following operation of a **Protection** system, of a failure to interrupt fault current by these circuit-breakers within the **Fault Current Interruption Time**, the circuit breaker fail **Protection** is required to initiate tripping of all the necessary electrically adjacent circuit-breakers so as to interrupt the fault current within the next 200ms.
- (d) The target performance for the **System Fault Dependability Index** shall be not less than 99%. This is a measure of the ability of **Protection** to initiate successful tripping of circuit breakers which are associated with the faulty items of **Apparatus**.

CC.6.2.3.2 Fault Disconnection Facilities

- (a) Where no **Transmission** circuit breaker is provided at the **GB Code User's** connection voltage, the **GB Code User** must provide **NGET** with the means of tripping all the **GB Code User's** circuit breakers necessary to isolate faults or **System** abnormalities on the **National Electricity Transmission System**. In these circumstances, for faults on the **GB Code User's System**, the **GB Code User's Protection** should also trip higher voltage **Transmission** circuit breakers. These tripping facilities shall be in accordance with the requirements specified in the **Bilateral Agreement**.
- (b) **NGET** may require the installation of a **System to Generator Operational Intertipping Scheme** in order to enable the timely restoration of circuits following power **System** fault(s). These requirements shall be set out in the relevant **Bilateral Agreement**.

CC.6.2.3.3 Automatic Switching Equipment

Where automatic reclosure of **Transmission** circuit breakers is required following faults on the **GB Code User's System**, automatic switching equipment shall be provided in accordance with the requirements specified in the **Bilateral Agreement**.

CC.6.2.3.4 Relay Settings

Protection and relay settings will be co-ordinated (both on connection and subsequently) across the **Connection Point** in accordance with the **Bilateral Agreement** to ensure effective disconnection of faulty **Apparatus**.

CC.6.2.3.5 Work on Protection equipment

Where a **Transmission Licensee** owns the busbar at the **Connection Point**, no busbar **Protection**, mesh corner **Protection** relays, AC or DC wiring (other than power supplies or DC tripping associated with the **Network Operator** or **Non-Embedded Customer's Apparatus** itself) may be worked upon or altered by the **Network Operator** or **Non-Embedded Customer** personnel in the absence of a representative of **NGET** or in Scotland, a representative of **NGET**, or written authority from **NGET** to perform such work or alterations in the absence of a representative of **NGET**.

CC.6.2.3.6 Equipment to be provided

CC.6.2.3.6.1 Protection of Interconnecting Connections

The requirements for the provision of **Protection** equipment for interconnecting connections will be specified in the **Bilateral Agreement**.

CC.6.3 GENERAL GENERATING UNIT (AND OTSDUW) REQUIREMENTS

CC.6.3.1 This section sets out the technical and design criteria and performance requirements for **Generating Units, DC Converters and Power Park Modules** (whether directly connected to the **National Electricity Transmission System** or **Embedded**) and (where provided in this section) **OTSDUW Plant and Apparatus** which each **GB Generator or DC Converter Station** owner must ensure are complied with in relation to its **Generating Units, DC Converters and Power Park Modules** and **OTSDUW Plant and Apparatus** but does not apply to **Small Power Stations** or individually to **Power Park Units**. References to **Generating Units, DC Converters and Power Park Modules** in this CC.6.3 should be read accordingly. The performance requirements that **OTSDUW Plant and Apparatus** must be capable of providing at the **Interface Point** under this section may be provided using a combination of **GB Generator Plant and Apparatus** and/or **OTSDUW Plant and Apparatus**.

Plant Performance Requirements

Formatted: Highlight

CC.6.3.2 (a) When supplying **Rated MW** all **Onshore Synchronous Generating Units** must be capable of continuous operation at any point between the limits 0.85 **Power Factor** lagging and 0.95 **Power Factor** leading at the **Onshore Synchronous Generating Unit** terminals. At **Active Power** output levels other than **Rated MW**, all **Onshore Synchronous Generating Units** must be capable of continuous operation at any point between the **Reactive Power** capability limits identified on the **Generator Performance Chart**.

In addition to the above paragraph, where **Onshore Synchronous Generating Unit(s)**:

- (i) have a **Connection Entry Capacity** which has been increased above **Rated MW** (or the **Connection Entry Capacity** of the **CCGT module** has increased above the sum of the **Rated MW** of the **Generating Units** comprising the **CCGT module**), and such increase takes effect after 1st May 2009, the minimum lagging **Reactive Power** capability at the terminals of the **Onshore Synchronous Generating Unit(s)** must be 0.9 **Power Factor** at all **Active Power** output levels in excess of **Rated MW**. Further, the **User** shall comply with the provisions of and any instructions given pursuant to BC1.8 and the relevant **Bilateral Agreement**; or
- (ii) have a **Connection Entry Capacity** in excess of **Rated MW** (or the **Connection Entry Capacity** of the **CCGT module** exceeds the sum of **Rated MW** of the **Generating Units** comprising the **CCGT module**) and a **Completion Date** before 1st May 2009, alternative provisions relating to **Reactive Power** capability may be specified in the **Bilateral Agreement** and where this is the case such provisions must be complied with.

The short circuit ratio of **Onshore Synchronous Generating Units** with an **Apparent Power** rating of less than 1600MVA shall be not less than 0.5. The short circuit ratio of **Onshore Synchronous Generating Units** with a rated **Apparent Power** of 1600MVA or above shall be not less than 0.4.

- (b) Subject to paragraph (c) below, all **Onshore Non-Synchronous Generating Units**, **Onshore DC Converters** and **Onshore Power Park Modules** must be capable of maintaining zero transfer of **Reactive Power** at the **Onshore Grid Entry Point** (or **User System Entry Point** if **Embedded**) at all **Active Power** output levels under steady state voltage conditions. For **Onshore Non-Synchronous Generating Units** and **Onshore Power Park Modules** the steady state tolerance on **Reactive Power** transfer to and from the **National Electricity Transmission System** expressed in MVA_r shall be no greater than 5% of the **Rated MW**. For **Onshore DC Converters** the steady state tolerance on **Reactive Power** transfer to and from the **National Electricity Transmission System** shall be specified in the **Bilateral Agreement**.

(c) Subject to the provisions of CC.6.3.2(d) below, all **Onshore Non-Synchronous Generating Units, Onshore DC Converters** (excluding current source technology) and **Onshore Power Park Modules** (excluding those connected to the **Total System** by a current source **Onshore DC Converter**) and **OTSDUW Plant and Apparatus** at the **Interface Point** with a **Completion Date** on or after 1 January 2006 must be capable of supplying **Rated MW output or Interface Point Capacity** in the case of **OTSDUW Plant and Apparatus** at any point between the limits 0.95 **Power Factor** lagging and 0.95 **Power Factor** leading at the **Onshore Grid Entry Point** in England and Wales or **Interface Point** in the case of **OTSDUW Plant and Apparatus** or at the HV side of the 33/132kV or 33/275kV or 33/400kV transformer for **GB Generators** directly connected to the **Onshore Transmission System** in Scotland (or **User System Entry Point** if **Embedded**). With all **Plant** in service, the **Reactive Power** limits defined at **Rated MW or Interface Point Capacity** in the case of **OTSDUW Plant and Apparatus** at **Lagging Power Factor** will apply at all **Active Power** output levels above 20% of the **Rated MW or Interface Point Capacity** in the case of **OTSDUW Plant and Apparatus** output as defined in Figure 1. With all **Plant** in service, the **Reactive Power** limits defined at **Rated MW at Leading Power Factor** will apply at all **Active Power** output levels above 50% of the **Rated MW output or Interface Point Capacity** in the case of **OTSDUW Plant and Apparatus** as defined in Figure 1. With all **Plant** in service, the **Reactive Power** limits will reduce linearly below 50% **Active Power** output as shown in Figure 1 unless the requirement to maintain the **Reactive Power** limits defined at **Rated MW or Interface Point Capacity** in the case of **OTSDUW Plant and Apparatus** at **Leading Power Factor** down to 20% **Active Power** output is specified in the **Bilateral Agreement**. These **Reactive Power** limits will be reduced pro rata to the amount of **Plant** in service.

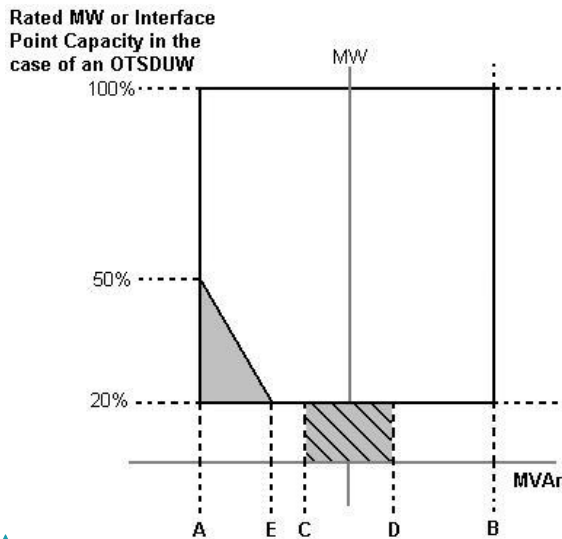

Figure 1

- Point A is equivalent (in MVar) to 0.95 leading Power Factor at Rated MW output or **Interface Point Capacity** in the case of **OTSDUW Plant and Apparatus**
- Point B is equivalent (in MVar) to: 0.95 lagging Power Factor at Rated MW output or **Interface Point Capacity** in the case of **OTSDUW Plant and Apparatus**
- Point C is equivalent (in MVar) to: -5% of Rated MW output or **Interface Point Capacity** in the case of **OTSDUW Plant and Apparatus**

Formatted: Highlight

Formatted: Highlight

Formatted: Highlight

Formatted: Highlight

Point D is equivalent to +5% of Rated MW output or Interface Point Capacity in the case (in MVar) to: of OTSDUW Plant and Apparatus

Formatted: Highlight

Point E is equivalent to -12% of Rated MW output or Interface Point Capacity in the case (in MVar) to: of OTSDUW Plant and Apparatus

Formatted: Highlight

(d) All Onshore Non-Synchronous Generating Units and Onshore Power Park Modules in Scotland with a Completion Date after 1 April 2005 and before 1 January 2006 must be capable of supplying Rated MW at the range of power factors either:

Formatted: Highlight

(i) from 0.95 lead to 0.95 lag as illustrated in Figure 1 at the User System Entry Point for Embedded GB Generators or at the HV side of the 33/132kV or 33/275kV or 33/400kV transformer for GB Generators directly connected to the Onshore Transmission System. With all Plant in service, the Reactive Power limits defined at Rated MW will apply at all Active Power output levels above 20% of the Rated MW output as defined in Figure 1. These Reactive Power limits will be reduced pro rata to the amount of Plant in service, or

(ii) from 0.95 lead to 0.90 lag at the Onshore Non-Synchronous Generating Unit (including Power Park Unit) terminals. For the avoidance of doubt GB Generators complying with this option (ii) are not required to comply with CC.6.3.2(b).

(e) The short circuit ratio of Offshore Synchronous Generating Units at a Large Power Station shall be not less than 0.5. At a Large Power Station all Offshore Synchronous Generating Units, Offshore Non-Synchronous Generating Units, Offshore DC Converters and Offshore Power Park Modules must be capable of maintaining:

(i) zero transfer of Reactive Power at the Offshore Grid Entry Point for all GB Generators with an Offshore Grid Entry Point at the LV Side of the Offshore Platform at all Active Power output levels under steady state voltage conditions. The steady state tolerance on Reactive Power transfer to and from an Offshore Transmission System expressed in MVar shall be no greater than 5% of the Rated MW, or

(ii) a transfer of Reactive Power at the Offshore Grid Entry Point at a value specified in the Bilateral Agreement that will be equivalent to zero at the LV Side of the Offshore Platform. In addition, the steady state tolerance on Reactive Power transfer to and from an Offshore Transmission System expressed in MVar at the LV Side of the Offshore Platform shall be no greater than 5% of the Rated MW, or

(iii) the Reactive Power capability (within associated steady state tolerance) specified in the Bilateral Agreement if any alternative has been agreed with the GB Generator, Offshore Transmission Licensee and NGET.

(f) In addition, a Genset shall meet the operational requirements as specified in BC2.A.2.6.

CC.6.3.3 Each Generating Unit, DC Converter (including an OTSDUW DC Converter), Power Park Module and/or CCGT Module must be capable of:

(a) continuously maintaining constant Active Power output for System Frequency changes within the range 50.5 to 49.5 Hz; and

(b) (subject to the provisions of CC.6.1.3) maintaining its **Active Power** output at a level not lower than the figure determined by the linear relationship shown in Figure 2 for **System Frequency** changes within the range 49.5 to 47 Hz, such that if the **System Frequency** drops to 47 Hz the **Active Power** output does not decrease by more than 5%. In the case of a **CCGT Module**, the above requirement shall be retained down to the **Low Frequency Relay** trip setting of 48.8 Hz, which reflects the first stage of the Automatic **Low Frequency Demand Disconnection** scheme notified to **Network Operators** under OC6.6.2. For **System Frequency** below that setting, the existing requirement shall be retained for a minimum period of 5 minutes while **System Frequency** remains below that setting, and special measure(s) that may be required to meet this requirement shall be kept in service during this period. After that 5 minutes period, if **System Frequency** remains below that setting, the special measure(s) must be discontinued if there is a materially increased risk of the **Gas Turbine** tripping. The need for special measure(s) is linked to the inherent **Gas Turbine Active Power** output reduction caused by reduced shaft speed due to falling **System Frequency**.

Formatted: Highlight

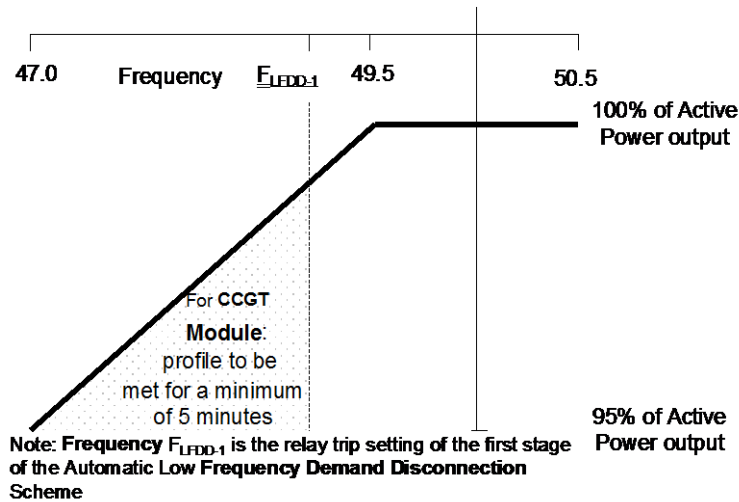

Figure 2

(c) For the avoidance of doubt in the case of a **Generating Unit** or **Power Park Module** (or **OTSDUW DC Converters** at the **Interface Point**) using an **Intermittent Power Source** where the mechanical power input will not be constant over time, the requirement is that the **Active Power** output shall be independent of **System Frequency** under (a) above and should not drop with **System Frequency** by greater than the amount specified in (b) above.

(d) A **DC Converter Station** must be capable of maintaining its **Active Power** input (i.e. when operating in a mode analogous to **Demand**) from the **National Electricity Transmission System** (or **User System** in the case of an **Embedded DC Converter Station**) at a level not greater than the figure determined by the linear relationship shown in Figure 3 for **System Frequency** changes within the range 49.5 to 47 Hz, such that if the **System Frequency** drops to 47.8 Hz the **Active Power** input decreases by more than 60%.

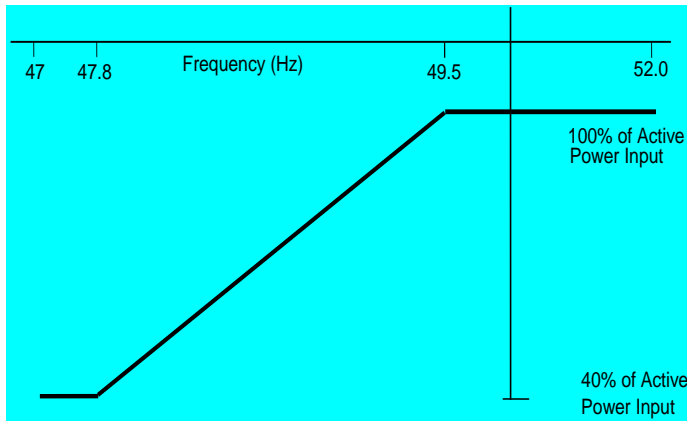

Figure 3

Formatted: Highlight

(e) At a Large Power Station, in the case of an Offshore Generating Unit, Offshore Power Park Module, Offshore DC Converter and OTSDUW DC Converter, the GB Generator shall comply with the requirements of CC.6.3.3. GB Generators should be aware that Section K of the STC places requirements on Offshore Transmission Licensees which utilise a Transmission DC Converter as part of their Offshore Transmission System to make appropriate provisions to enable GB Generators to fulfil their obligations.

(f) In the case of an OTSDUW DC Converter the OTSDUW Plant and Apparatus shall provide a continuous signal indicating the real time frequency measured at the Interface Point to the Offshore Grid Entry Point.

CC.6.3.4 At the Grid Entry Point, the Active Power output under steady state conditions of any Generating Unit, DC Converter or Power Park Module directly connected to the National Electricity Transmission System or in the case of OTSDUW, the Active Power transfer at the Interface Point, under steady state conditions of any OTSDUW Plant and Apparatus should not be affected by voltage changes in the normal operating range specified in paragraph CC.6.1.4 by more than the change in Active Power losses at reduced or increased voltage. In addition:

(a) For any Onshore Generating Unit, Onshore DC Converter and Onshore Power Park Module or OTSDUW the Reactive Power output under steady state conditions should be fully available within the voltage range $\pm 5\%$ at 400kV, 275kV and 132kV and lower voltages, except for an Onshore Power Park Module or Onshore Non-Synchronous Generating Unit if Embedded at 33kV and below (or directly connected to the Onshore Transmission System at 33kV and below) where the requirement shown in Figure 4 applies.

Formatted: Highlight

Formatted: Highlight

(b) At a Large Power Station, in the case of an Offshore Generating Unit, Offshore DC Converter and Offshore Power Park Module where an alternative reactive capability has been agreed with the GB Generator, as specified in CC.6.3.2(e) (iii), the voltage / Reactive Power requirement shall be specified in the Bilateral Agreement. The Reactive Power output under steady state conditions shall be fully available within the voltage range $\pm 5\%$ at 400kV, 275kV and 132kV and lower voltages.

Formatted: Highlight

Formatted: Highlight

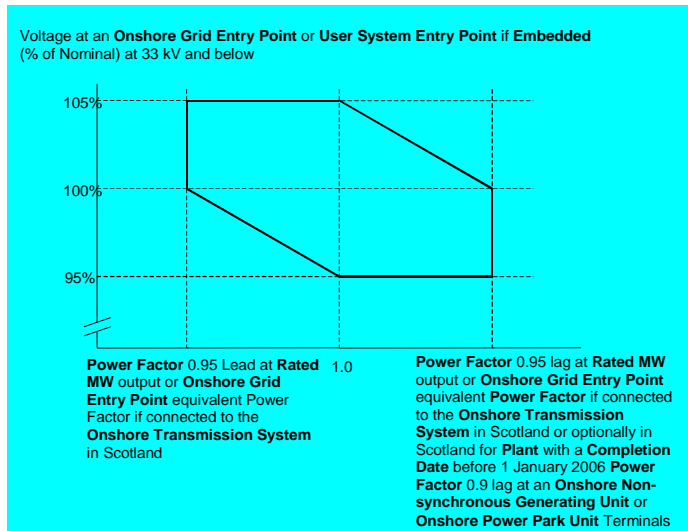

Figure 4

CC.6.3.5 It is an essential requirement that the National Electricity Transmission System must incorporate a Black Start Capability. This will be achieved by agreeing a Black Start Capability at a number of strategically located Power Stations. For each Power Station NGET will state in the Bilateral Agreement whether or not a Black Start Capability is required.

Control Arrangements

CC.6.3.6 (a) Each:

- (i) Offshore Generating Unit in a Large Power Station or Onshore Generating Unit; or,
- (ii) Onshore DC Converter with a Completion Date on or after 1 April 2005 or Offshore DC Converter at a Large Power Station; or,
- (iii) Onshore Power Park Module in England and Wales with a Completion Date on or after 1 January 2006; or,
- (iv) Onshore Power Park Module in operation in Scotland on or after 1 January 2006 (with a Completion Date after 1 July 2004 and in a Power Station with a Registered Capacity of 50MW or more); or,
- (v) Offshore Power Park Module in a Large Power Station with a Registered Capacity of 50MW or more;

must be capable of contributing to Frequency control by continuous modulation of Active Power supplied to the National Electricity Transmission System or the User System in which it is Embedded. For the avoidance of doubt each OTSDUW DC Converter shall provide each GB Code User in respect of its Offshore Power Stations connected to and/or using an Offshore Transmission System a continuous signal indicating the real time Frequency measured at the Transmission Interface Point.

(b) Each:

- (i) Onshore Generating Unit; or,
- (ii) Onshore DC Converter (with a Completion Date on or after 1 April 2005 excluding current source technologies); or

Formatted: Highlight

(iii) **Onshore Power Park Module** in England and Wales with a **Completion Date** on or after 1 January 2006; or,

(iv) **Onshore Power Park Module** in Scotland irrespective of **Completion Date**; or,

(v) **Offshore Generating Unit** at a **Large Power Station**, **Offshore DC Converter** at a **Large Power Station** or **Offshore Power Park Module** at a **Large Power Station** which provides a reactive range beyond the minimum requirements specified in CC.6.3.2(e) (iii); or,

(vi) **OTSDUW Plant and Apparatus** at a **Transmission Interface Point**

must be capable of contributing to voltage control by continuous changes to the **Reactive Power** supplied to the **National Electricity Transmission System** or the **User System** in which it is **Embedded**.

CC.6.3.7 (a) Each **Generating Unit**, **DC Converter** or **Power Park Module** (excluding **Onshore Power Park Modules** in Scotland with a **Completion Date** before 1 July 2004 or **Onshore Power Park Modules** in a **Power Station** in Scotland with a **Registered Capacity** less than 50MW or **Offshore Power Park Modules** in a **Large Power Station** located **Offshore** with a **Registered Capacity** less than 50MW) must be fitted with a fast acting proportional **Frequency** control device (or turbine speed governor) and unit load controller or equivalent control device to provide **Frequency** response under normal operational conditions in accordance with **Balancing Code 3 (BC3)**. In the case of a **Power Park Module** the **Frequency** or speed control device(s) may be on the **Power Park Module** or on each individual **Power Park Unit** or be a combination of both. The **Frequency** control device(s) (or speed governor(s)) must be designed and operated to the appropriate:

(i) **European Specification**; or

(ii) in the absence of a relevant **European Specification**, such other standard which is in common use within the European Community (which may include a manufacturer specification);

as at the time when the installation of which it forms part was designed or (in the case of modification or alteration to the **Frequency** control device (or turbine speed governor)) when the modification or alteration was designed.

The **European Specification** or other standard utilised in accordance with subparagraph CC.6.3.7 (a) (ii) will be notified to **NGET** by the **GB Generator** or **DC Converter Station** owner or, in the case of an **Embedded Medium Power Station** not subject to a **Bilateral Agreement** or **Embedded DC Converter Station** not subject to a **Bilateral Agreement**, the relevant **Network Operator**:

(i) as part of the application for a **Bilateral Agreement**; or

(ii) as part of the application for a varied **Bilateral Agreement**; or

(iii) in the case of an **Embedded Development**, within 28 days of entry into the **Embedded Development Agreement** (or such later time as agreed with **NGET**); or

(iv) as soon as possible prior to any modification or alteration to the **Frequency** control device (or governor); and

(b) The **Frequency** control device (or speed governor) in co-ordination with other control devices must control the **Generating Unit**, **DC Converter** or **Power Park Module** **Active Power Output** with stability over the entire operating range of the **Generating Unit**, **DC Converter** or **Power Park Module**; and

(c) The **Frequency** control device (or speed governor) must meet the following minimum requirements:

(i) Where a **Generating Unit**, **DC Converter** or **Power Park Module** becomes

isolated from the rest of the **Total System** but is still supplying **Customers**, the **Frequency** control device (or speed governor) must also be able to control **System Frequency** below 52Hz unless this causes the **Generating Unit, DC Converter or Power Park Module** to operate below its **Designed Minimum Operating Level** when it is possible that it may, as detailed in BC 3.7.3, trip after a time. For the avoidance of doubt the **Generating Unit, DC Converter or Power Park Module** is only required to operate within the **System Frequency** range 47 - 52 Hz as defined in CC.6.1.3;

- (ii) the **Frequency** control device (or speed governor) must be capable of being set so that it operates with an overall speed **Droop** of between 3% and 5%. For the avoidance of doubt, in the case of a **Power Park Module** the speed **Droop** should be equivalent of a fixed setting between 3% and 5% applied to each **Power Park Unit** in service;
- (iii) in the case of all **Generating Units, DC Converter or Power Park Module** other than the **Steam Unit** within a **CCGT Module** the **Frequency** control device (or speed governor) deadband should be no greater than 0.03Hz (for the avoidance of doubt, $\pm 0.015\text{Hz}$). In the case of the **Steam Unit** within a **CCGT Module**, the speed **Governor Deadband** should be set to an appropriate value consistent with the requirements of CC.6.3.7(c)(i) and the requirements of BC3.7.2 for the provision of **Limited High Frequency Response**;

For the avoidance of doubt, the minimum requirements in (ii) and (iii) for the provision of **System Ancillary Services** do not restrict the negotiation of **Commercial Ancillary Services** between **NGET** and the **GB Code User** using other parameters; and

- (d) A facility to modify, so as to fulfil the requirements of the **Balancing Codes**, the **Target Frequency** setting either continuously or in a maximum of 0.05 Hz steps over at least the range 50 ± 0.1 Hz should be provided in the unit load controller or equivalent device;
- (e)
 - (i) Each **Onshore Generating Unit** and/or **CCGT Module** which has a **Completion Date** after 1 January 2001 in England and Wales, and after 1 April 2005 in Scotland, must be capable of meeting the minimum **Frequency** response requirement profile subject to and in accordance with the provisions of Appendix 3;
 - (ii) Each **DC Converter** at a **DC Converter Station** which has a **Completion Date** on or after 1 April 2005 and each **Offshore DC Converter** at a **Large Power Station** must be capable of meeting the minimum **Frequency** response requirement profile subject to and in accordance with the provisions of Appendix 3;
 - (iii) Each **Onshore Power Park Module** in operation in England and Wales with a **Completion Date** on or after 1 January 2006 must be capable of meeting the minimum **Frequency** response requirement profile subject to and in accordance with the provisions of Appendix 3;
 - (iv) Each **Onshore Power Park Module** in operation on or after 1 January 2006 in Scotland (with a **Completion Date** on or after 1 April 2005 and a **Registered Capacity** of 50MW or more) must be capable of meeting the minimum **Frequency** response requirement profile subject to and in accordance with the provisions of Appendix 3;
 - (v) Each **Offshore Generating Unit** in a **Large Power Station** must be capable of meeting the minimum **Frequency** response requirement profile subject to and in accordance with the provisions of Appendix 3;
 - (vi) Each **Offshore Power Park Module** in a **Large Power Station** with a **Registered Capacity** of 50 MW or greater, must be capable of meeting the minimum **Frequency** response requirement profile subject to and in accordance with the provisions of Appendix 3;
 - (vii) Subject to the requirements of CC.6.3.7(e), **Offshore Generating Units** at a **Large Power Station**, **Offshore Power Park Modules** at a **Large Power Station** and **Offshore DC Converters** in a **Large Power Station** shall comply with the

Formatted: Highlight

Formatted: Highlight

requirements of CC.6.3.7. **GB Generators** should be aware that Section K of the **STC** places requirements on **Offshore Transmission Licensees** which utilise a **Transmission DC Converter** as part of their **Offshore Transmission System** to make appropriate provisions to enable **GB Generators** to fulfil their obligations.

(viii) Each **OTSDUW DC Converter** must be capable of providing a continuous signal indicating the real time frequency measured at the **Interface Point** to the **Offshore Grid Entry Point**.

(f) For the avoidance of doubt, the requirements of Appendix 3 do not apply to:

(i) **Generating Units** and/or **CCGT Modules** which have a **Completion Date** before 1 January 2001 in England and Wales, and before 1 April 2005 in Scotland, for whom the remaining requirements of this clause CC.6.3.7 shall continue to apply unchanged; or

(ii) **DC Converters** at a **DC Converter Station** which have a **Completion Date** before 1 April 2005; or

(iii) **Onshore Power Park Modules** in England and Wales with a **Completion Date** before 1 January 2006 for whom only the requirements of **Limited Frequency Sensitive Mode** (BC3.5.2) operation shall apply; or

(iv) **Onshore Power Park Modules** in operation in Scotland before 1 January 2006 for whom only the requirements of **Limited Frequency Sensitive Mode** (BC3.5.2) operation shall apply; or

(v) **Onshore Power Park Modules** in operation after 1 January 2006 in Scotland which have a **Completion Date** before 1 April 2005 for whom the remaining requirements of this clause CC.6.3.7 shall continue to apply unchanged; or

(vi) **Offshore Power Park Modules** which are in a **Large Power Station** with a **Registered Capacity** less than 50MW for whom only the requirements of **Limited Frequency Sensitive Mode** (BC3.5.2) operation shall apply; or

Excitation and Voltage Control Performance Requirements

CC.6.3.8 (a) Excitation and voltage control performance requirements applicable to **Onshore Generating Units, Onshore Power Park Modules, Onshore DC Converters and OTSDUW Plant and Apparatus**.

(i) A continuously-acting automatic excitation control system is required to provide constant terminal voltage control of the **Onshore Synchronous Generating Unit** without instability over the entire operating range of the **Onshore Generating Unit**.

(ii) In respect of **Onshore Synchronous Generating Units** with a **Completion Date** before 1 January 2009, the requirements for excitation control facilities, including **Power System Stabilisers**, where in **NGET's** view these are necessary for system reasons, will be specified in the **Bilateral Agreement**. If any **Modification** to the excitation control facilities of such **Onshore Synchronous Generating Units** is made on or after 1 January 2009 the requirements that shall apply may be specified in the **Bilateral Agreement** as varied. To the extent that the **Bilateral Agreement** does not specify, the requirements given or referred to in CC.A.6 shall apply. The performance requirements for a continuously acting automatic excitation control system that shall be complied with by the **GB Code User** in respect of such **Onshore Synchronous Generating Units** with a **Completion Date** on or after 1 January 2009 are given or referred to in CC.A.6. Reference is made to on-load commissioning witnessed by **NGET** in BC2.11.2.

(iii) In the case of an **Onshore Non-Synchronous Generating Unit, Onshore DC Converter, Onshore Power Park Module or OTSDUW Plant and Apparatus** at the **Interface Point** a continuously-acting automatic control system is required to provide control of the voltage (or zero transfer of **Reactive Power** as applicable to CC.6.3.2) at the **Onshore Grid Entry Point** or **User System Entry Point** or in the case of **OTSDUW Plant and Apparatus at the Interface Point** without instability

over the entire operating range of the **Onshore Non-Synchronous Generating Unit, Onshore DC Converter, Onshore Power Park Module or OTSDUW Plant and Apparatus**. Any **Plant or Apparatus** used in the provisions of such voltage control within an **Onshore Power Park Module** may be located at the **Power Park Unit** terminals, an appropriate intermediate busbar or the **Connection Point**. **OTSDUW Plant and Apparatus** used in the provision of such voltage control may be located at the **Offshore Grid Entry Point**, an appropriate intermediate busbar or at the **Interface Point**. In the case of an **Onshore Power Park Module** in Scotland with a **Completion Date** before 1 January 2009, voltage control may be at the **Power Park Unit** terminals, an appropriate intermediate busbar or the **Connection Point** as specified in the **Bilateral Agreement**. When operating below **20% Rated MW** the automatic control system may continue to provide voltage control utilising any available reactive capability. If voltage control is not being provided the automatic control system shall be designed to ensure a smooth transition between the shaded area bound by CD and the non shaded area bound by AB in Figure 1 of CC.6.3.2 (c).

(iv) The performance requirements for a continuously acting automatic voltage control system in respect of **Onshore Power Park Modules, Onshore Non-Synchronous Generating Units and Onshore DC Converters** with a **Completion Date** before 1 January 2009 will be specified in the **Bilateral Agreement**. If any **Modification** to the continuously acting automatic voltage control system of such **Onshore Power Park Modules, Onshore Non-Synchronous Generating Units and Onshore DC Converters** is made on or after 1 January 2009 the requirements that shall apply may be specified in the **Bilateral Agreement** as varied. To the extent that the **Bilateral Agreement** does not specify, the requirements given or referred to in CC.A.7 shall apply. The performance requirements for a continuously acting automatic voltage control system that shall be complied with by the **GB Code User** in respect of **Onshore Power Park Modules, Onshore Non-Synchronous Generating Units and Onshore DC Converters or OTSDUW Plant and Apparatus** at the **Interface Point** with a **Completion Date** on or after 1 January 2009 are given or referred to in CC.A.7.

(v) Unless otherwise required for testing in accordance with OC5.A.2, the automatic excitation control system of an **Onshore Synchronous Generating Unit** shall always be operated such that it controls the **Onshore Synchronous Generating Unit** terminal voltage to a value that is

- equal to its rated value; or
- only where provisions have been made in the **Bilateral Agreement**, greater than its rated value.

(vi) In particular, other control facilities, including constant **Reactive Power** output control modes and constant **Power Factor** control modes (but excluding VAR limiters) are not required. However, if present in the excitation or voltage control system they will be disabled unless the **Bilateral Agreement** records otherwise. Operation of such control facilities will be in accordance with the provisions contained in **BC2**.

(b) Excitation and voltage control performance requirements applicable to **Offshore Generating Units at a Large Power Station, Offshore Power Park Modules at a Large Power Station and Offshore DC Converters at a Large Power Station**.

A continuously acting automatic control system is required to provide either:

(i) control of **Reactive Power** (as specified in CC.6.3.2(e) (i) (ii)) at the **Offshore Grid Entry Point** without instability over the entire operating range of the **Offshore Generating Unit, Offshore DC Converter or Offshore Power Park Module**. The performance requirements for this automatic control system will be specified in the **Bilateral Agreement** or;

(ii) where an alternative reactive capability has been specified in the **Bilateral Agreement**, in accordance with CC.6.3.2 (e) (iii), the **Offshore Generating Unit, Offshore Power Park Module or Offshore DC Converter** will be required to control voltage and / or **Reactive Power** without instability over the entire operating range of the **Offshore Generating Unit, Offshore Power Park Module or Offshore DC Converter**. The performance requirements of the control system will be specified in the **Bilateral Agreement**.

In addition to CC.6.3.8(b) (i) and (ii) the requirements for excitation control facilities, including **Power System Stabilisers**, where in **NGET's** view these are necessary for system reasons, will be specified in the **Bilateral Agreement**. Reference is made to on-load commissioning witnessed by **NGET** in BC2.11.2.

Steady state Load Inaccuracies

CC.6.3.9 The standard deviation of **Load** error at steady state **Load** over a 30 minute period must not exceed 2.5 per cent of a **Genset's Registered Capacity**. Where a **Genset** is instructed to **Frequency** sensitive operation, allowance will be made in determining whether there has been an error according to the governor droop characteristic registered under the **PC**.

For the avoidance of doubt in the case of a **Power Park Module** allowance will be made for the full variation of mechanical power output.

Negative Phase Sequence Loadings

CC.6.3.10 In addition to meeting the conditions specified in CC.6.1.5(b), each **Synchronous Generating Unit** will be required to withstand, without tripping, the negative phase sequence loading incurred by clearance of a close-up phase-to-phase fault, by **System Back-Up Protection** on the **National Electricity Transmission System** or **User System** located **Onshore** in which it is **Embedded**.

Neutral Earthing

CC.6.3.11 At nominal **System** voltages of 132kV and above the higher voltage windings of a transformer of a **Generating Unit, DC Converter, Power Park Module** or transformer resulting from **OTSDUW** must be star connected with the star point suitable for connection to earth. The earthing and lower voltage winding arrangement shall be such as to ensure that the **Earth Fault Factor** requirement of paragraph CC.6.2.1.1 (b) will be met on the **National Electricity Transmission System** at nominal **System** voltages of 132kV and above.

Frequency Sensitive Relays

CC.6.3.12 As stated in CC.6.1.3, the **System Frequency** could rise to 52Hz or fall to 47Hz. Each **Generating Unit, DC Converter, OTSDUW Plant and Apparatus, Power Park Module** or any constituent element must continue to operate within this **Frequency** range for at least the periods of time given in CC.6.1.3 unless **NGET** has agreed to any **Frequency**-level relays and/or rate-of-change-of-**Frequency** relays which will trip such **Generating Unit, DC Converter, OTSDUW Plant and Apparatus, Power Park Module** and any constituent element within this **Frequency** range, under the **Bilateral Agreement**.

CC.6.3.13 **GB Generators** (including in respect of **OTSDUW Plant and Apparatus**) and **DC Converter Station** owners will be responsible for protecting all their **Generating Units** (and **OTSDUW Plant and Apparatus**), **DC Converters** or **Power Park Modules** against damage should **Frequency** excursions outside the range 52Hz to 47Hz ever occur. Should such excursions occur, it is up to the **GB Generator** or **DC Converter Station** owner to decide whether to disconnect his **Apparatus** for reasons of safety of **Apparatus, Plant** and/or personnel.

CC.6.3.14 It may be agreed in the **Bilateral Agreement** that a **Genset** shall have a **Fast-Start Capability**. Such **Gensets** may be used for **Operating Reserve** and their **Start-Up** may be initiated by **Frequency**-level relays with settings in the range 49Hz to 50Hz as specified pursuant to **OC2**.

CC.6.3.15 Fault Ride Through

This section sets out the fault ride through requirements on **Generating Units, Power Park Modules, DC Converters and OTSDUW Plant and Apparatus. Onshore Generating Units, Onshore Power Park Modules, Onshore DC Converters** (including **Embedded Medium Power Stations and Embedded DC Converter Stations** not subject to a **Bilateral Agreement** and with an **Onshore User System Entry Point** (irrespective of whether they are located **Onshore or Offshore**)) and **OTSDUW Plant and Apparatus** are required to operate through **System** faults and disturbances as defined in CC.6.3.15.1 (a), CC.6.3.15.1 (b) and CC.6.3.15.3. **Offshore GB Generators** in respect of **Offshore Generating Units** at a **Large Power Station, Offshore Power Park Modules** at a **Large Power Station** and **DC Converter Station** owners in respect of **Offshore DC Converters** at a **Large Power Station** shall have the option of meeting either:

- (i) CC.6.3.15.1 (a), CC.6.3.15.1 (b) and CC.6.3.15.3, or;
- (ii) CC.6.3.15.2 (a), CC.6.3.15.2 (b) and CC.6.3.15.3

Offshore GB Generators and **Offshore DC Converter** owners, should notify **NGET** which option they wish to select within 28 days (or such longer period as **NGET** may agree, in any event this being no later than 3 months before the **Completion Date** of the offer for a final **CUSC Contract** which would be made following the appointment of the **Offshore Transmission Licensee**).

CC.6.3.15.1 Fault Ride through applicable to Generating Units, Power Park Modules and DC Converters and OTSDUW Plant and Apparatus

(a) Short circuit faults on the **Onshore Transmission System** (which may include an **Interface Point**) at **Supergrid Voltage** up to 140ms in duration.

(i) Each **Generating Unit, DC Converter, or Power Park Module** and any constituent **Power Park Unit** thereof and **OTSDUW Plant and Apparatus** shall remain transiently stable and connected to the **System** without tripping of any **Generating Unit, DC Converter or Power Park Module** and / or any constituent **Power Park Unit, OTSDUW Plant and Apparatus**, and for **Plant and Apparatus** installed on or after 1 December 2017, reactive compensation equipment, for a close-up solid three-phase short circuit fault or any unbalanced short circuit fault on the **Onshore Transmission System** (including in respect of **OTSDUW Plant and Apparatus, the Interface Point**) operating at **Supergrid Voltages** for a total fault clearance time of up to 140 ms. A solid three-phase or unbalanced earthed fault results in zero voltage on the faulted phase(s) at the point of fault. The duration of zero voltage is dependent on local **Protection** and circuit breaker operating times. This duration and the fault clearance times will be specified in the **Bilateral Agreement**. Following fault clearance, recovery of the **Supergrid Voltage** on the **Onshore Transmission System** to 90% may take longer than 140ms as illustrated in Appendix 4A Figures CC.A.4A.1 (a) and (b). It should be noted that in the case of an **Offshore Generating Unit, Offshore DC Converter or Offshore Power Park Module** (including any **Offshore Power Park Unit** thereof) which is connected to an **Offshore Transmission System** which includes a **Transmission DC Converter** as part of that **Offshore Transmission System, the Offshore Grid Entry Point** voltage may not indicate the presence of a fault on the **Onshore Transmission System**. The fault will affect the level of **Active Power** that can be transferred to the **Onshore Transmission System** and therefore subject the **Offshore Generating Unit, Offshore DC Converter or Offshore Power Park Module** (including any **Offshore Power Park Unit** thereof) to a load rejection.

(ii) Each **Generating Unit, Power Park Module** and **OTSDUW Plant and Apparatus**, shall be designed such that upon both clearance of the fault on the **Onshore Transmission System** as detailed in CC.6.3.15.1 (a) (i) and within 0.5 seconds of the restoration of the voltage at the **Onshore Grid Entry Point** (for **Onshore Generating Units or Onshore Power Park Modules**) or **Interface Point** (for **Offshore Generating Units, Offshore Power Park Modules** or **OTSDUW Plant**

and Apparatus) to the minimum levels specified in CC.6.1.4 (or within 0.5 seconds of restoration of the voltage at the **User System Entry Point** to 90% of nominal or greater if **Embedded**), **Active Power** output or in the case of **OTSDUW Plant and Apparatus**, **Active Power** transfer capability, shall be restored to at least 90% of the level available immediately before the fault. Once the **Active Power** output, or in the case of **OTSDUW Plant and Apparatus**, **Active Power** transfer capability, has been restored to the required level, **Active Power** oscillations shall be acceptable provided that:

- the total **Active Energy** delivered during the period of the oscillations is at least that which would have been delivered if the **Active Power** was constant
- the oscillations are adequately damped

During the period of the fault as detailed in CC.6.3.15.1 (a) (i) for which the voltage at the **Grid Entry Point** (or **Interface Point** in the case of **OTSDUW Plant and Apparatus**) is outside the limits specified in CC.6.1.4, each **Generating Unit** or **Power Park Module** or **OTSDUW Plant and Apparatus** shall generate maximum reactive current without exceeding the transient rating limit of the **Generating Unit**, **OTSDUW Plant and Apparatus** or **Power Park Module** and / or any constituent **Power Park Unit** or reactive compensation equipment. For **Plant and Apparatus** installed on or after 1 December 2017, switched reactive compensation equipment (such as mechanically switched capacitors and reactors) shall be controlled such that it is not switched in or out of service during the fault but may act to assist in post fault voltage recovery.

- (iii) Each **DC Converter** shall be designed to meet the **Active Power** recovery characteristics (and **OTSDUW DC Converter** shall be designed to meet the **Active Power** transfer capability at the **Interface Point**) as specified in the **Bilateral Agreement** upon clearance of the fault on the **Onshore Transmission System** as detailed in CC.6.3.15.1 (a) (i).

(b) **Supergrid Voltage** dips on the **Onshore Transmission System** greater than 140ms in duration

(1b) Requirements applicable to **Synchronous Generating Units** subject to **Supergrid Voltage** dips on the **Onshore Transmission System** greater than 140ms in duration.

In addition to the requirements of CC.6.3.15.1 (a) each **Synchronous Generating Unit**, each with a **Completion Date** on or after 1 April 2005 shall:

- (i) remain transiently stable and connected to the **System** without tripping of any **Synchronous Generating Unit** for balanced **Supergrid Voltage** dips and associated durations on the **Onshore Transmission System** (which could be at the **Interface Point**) anywhere on or above the heavy black line shown in Figure 5a. Appendix 4A and Figures CC.A.4A.3.2 (a), (b) and (c) provide an explanation and illustrations of Figure 5a; and,

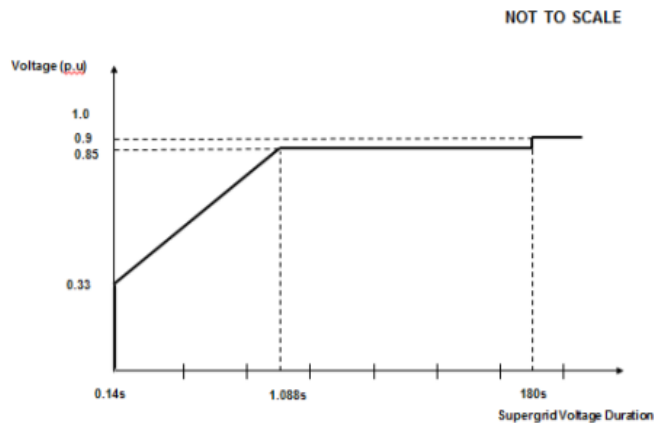

Figure 5a

(ii) provide **Active Power** output at the **Grid Entry Point**, during **Supergrid Voltage** dips on the **Onshore Transmission System** as described in Figure 5a, at least in proportion to the retained balanced voltage at the **Onshore Grid Entry Point** (for **Onshore Synchronous Generating Units**) or **Interface Point** (for **Offshore Synchronous Generating Units**) (or the retained balanced voltage at the **User System Entry Point** if **Embedded**) and shall generate maximum reactive current (where the voltage at the **Grid Entry Point** is outside the limits specified in CC.6.1.4) without exceeding the transient rating limits of the **Synchronous Generating Unit** and,

(iii) restore **Active Power** output following **Supergrid Voltage** dips on the **Onshore Transmission System** as described in Figure 5a, within 1 second of restoration of the voltage to 1.0p.u of the nominal voltage at the:

Onshore Grid Entry Point for directly connected **Onshore Synchronous Generating Units** or,

Interface Point for **Offshore Synchronous Generating Units** or,

User System Entry Point for **Embedded Onshore Synchronous Generating Units** or,

User System Entry Point for **Embedded Medium Power Stations** not subject to a **Bilateral Agreement** which comprise **Synchronous Generating Units** and with an **Onshore User System Entry Point** (irrespective of whether they are located **Onshore** or **Offshore**)

to at least 90% of the level available immediately before the occurrence of the dip. Once the **Active Power** output has been restored to the required level, **Active Power** oscillations shall be acceptable provided that:

- the total **Active Energy** delivered during the period of the oscillations is at least that which would have been delivered if the **Active Power** was constant
- the oscillations are adequately damped.

For the avoidance of doubt a balanced **Onshore Transmission System Supergrid Voltage** meets the requirements of CC.6.1.5 (b) and CC.6.1.6.

(2b) Requirements applicable to **OTSDUW Plant and Apparatus** and **Power Park Modules** subject to **Supergrid Voltage** dips on the **Onshore Transmission System** greater than 140ms in duration

Formatted: Highlight

Formatted: Highlight

In addition to the requirements of CC.6.3.15.1 (a) each **OTSDUW Plant and Apparatus** or each **Power Park Module** and / or any constituent **Power Park Unit**, each with a **Completion Date** on or after the 1 April 2005 shall:

- (i) remain transiently stable and connected to the **System** without tripping of any **OTSDUW Plant and Apparatus**, or **Power Park Module** and / or any constituent **Power Park Unit**, for balanced **Supergrid Voltage** dips and associated durations on the **Onshore Transmission System** (which could be at the **Interface Point**) anywhere on or above the heavy black line shown in Figure 5b. Appendix 4A and Figures CC.A.4A.3.4 (a), (b) and (c) provide an explanation and illustrations of Figure 5b; and,

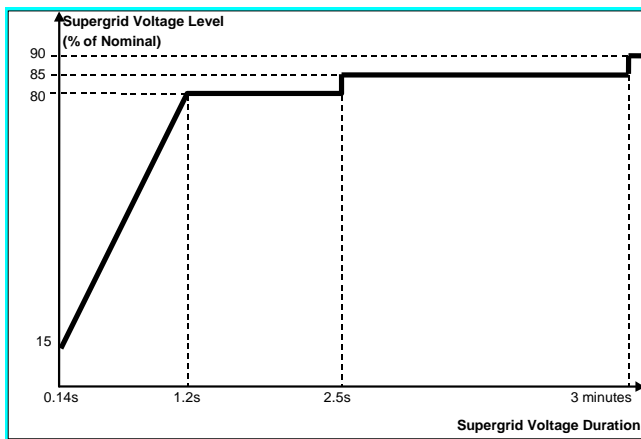

Figure 5b

- (ii) provide **Active Power** output at the **Grid Entry Point** or in the case of an **OTSDUW**, **Active Power** transfer capability at the **Transmission Interface Point**, during **Supergrid Voltage** dips on the **Onshore Transmission System** as described in Figure 5b, at least in proportion to the retained balanced voltage at the **Onshore Grid Entry Point** (for **Onshore Power Park Modules**) or **Interface Point** (for **OTSDUW Plant and Apparatus** and **Offshore Power Park Modules**) (or the retained balanced voltage at the **User System Entry Point** if **Embedded**) except in the case of a **Non-Synchronous Generating Unit** or **OTSDUW Plant and Apparatus** or **Power Park Module** where there has been a reduction in the **Intermittent Power Source** or in the case of **OTSDUW Active Power** transfer capability in the time range in Figure 5b that restricts the **Active Power** output or in the case of an **OTSDUW Active Power** transfer capability below this level and shall generate maximum reactive current (where the voltage at the **Grid Entry Point**, or in the case of an **OTSDUW Plant and Apparatus**, the **Interface Point** voltage, is outside the limits specified in CC.6.1.4) without exceeding the transient rating limits of the **OTSDUW Plant and Apparatus** or **Power Park Module** and any constituent **Power Park Unit**; and,

- (iii) restore **Active Power** output (or, in the case of **OTSDUW**, **Active Power** transfer capability), following **Supergrid Voltage** dips on the **Onshore Transmission System** as described in Figure 5b, within 1 second of restoration of the voltage at the:

Onshore Grid Entry Point for directly connected **Onshore Power Park Modules** or,

Formatted: Highlight

Interface Point for OTSDUW Plant and Apparatus and Offshore Power Park Modules or,

User System Entry Point for Embedded Onshore Power Park Modules or

User System Entry Point for Embedded Medium Power Stations which comprise Power Park Modules not subject to a Bilateral Agreement and with an Onshore User System Entry Point (irrespective of whether they are located Onshore or Offshore)

to the minimum levels specified in CC.6.1.4 to at least 90% of the level available immediately before the occurrence of the dip except in the case of a **Non-Synchronous Generating Unit, OTSDUW Plant and Apparatus or Power Park Module** where there has been a reduction in the **Intermittent Power Source** in the time range in Figure 5b that restricts the **Active Power** output or, in the case of **OTSDUW, Active Power** transfer capability below this level. Once the **Active Power** output or, in the case of **OTSDUW, Active Power** transfer capability has been restored to the required level, **Active Power** oscillations shall be acceptable provided that:

- the total **Active Energy** delivered during the period of the oscillations is at least that which would have been delivered if the **Active Power** was constant
- the oscillations are adequately damped.

For the avoidance of doubt a balanced **Onshore Transmission System Supergrid Voltage** meets the requirements of CC.6.1.5 (b) and CC.6.1.6.

CC.6.3.15.2 Fault Ride Through applicable to **Offshore Generating Units at a Large Power Station, Offshore Power Park Modules at a Large Power Station and Offshore DC Converters at a Large Power Station** who choose to meet the fault ride through requirements at the **LV side of the Offshore Platform**

(a) Requirements on **Offshore Generating Units, Offshore Power Park Modules and Offshore DC Converters** to withstand voltage dips on the **LV Side of the Offshore Platform** for up to 140ms in duration as a result of faults and / or voltage dips on the **Onshore Transmission System** operating at **Supergrid Voltage**

(i) Each **Offshore Generating Unit, Offshore DC Converter, or Offshore Power Park Module** and any constituent **Power Park Unit** thereof shall remain transiently stable and connected to the **System** without tripping of any **Offshore Generating Unit, or Offshore DC Converter or Offshore Power Park Module** and / or any constituent **Power Park Unit** or, in the case of **Plant and Apparatus** installed on or after 1 December 2017, reactive compensation equipment, for any balanced or unbalanced voltage dips on the **LV Side of the Offshore Platform** whose profile is anywhere on or above the heavy black line shown in Figure 6. For the avoidance of doubt, the profile beyond 140ms in Figure 6 shows the minimum recovery in voltage that will be seen by the generator following clearance of the fault at 140ms. Appendix 4B and Figures CC.A.4B.2 (a) and (b) provide further illustration of the voltage recovery profile that may be seen. It should be noted that in the case of an **Offshore Generating Unit, Offshore DC Converter or Offshore Power Park Module** (including any **Offshore Power Park Unit** thereof) which is connected to an **Offshore Transmission System** which includes a **Transmission DC Converter** as part of that **Offshore Transmission System**, the **Offshore Grid Entry Point** voltage may not indicate the presence of a fault on the **Onshore Transmission System**. The voltage dip will affect the level of **Active Power** that can be transferred to the **Onshore Transmission System** and therefore subject the **Offshore Generating Unit, Offshore DC Converter or Offshore Power Park Module** (including any **Offshore Power Park Unit** thereof) to a load rejection.

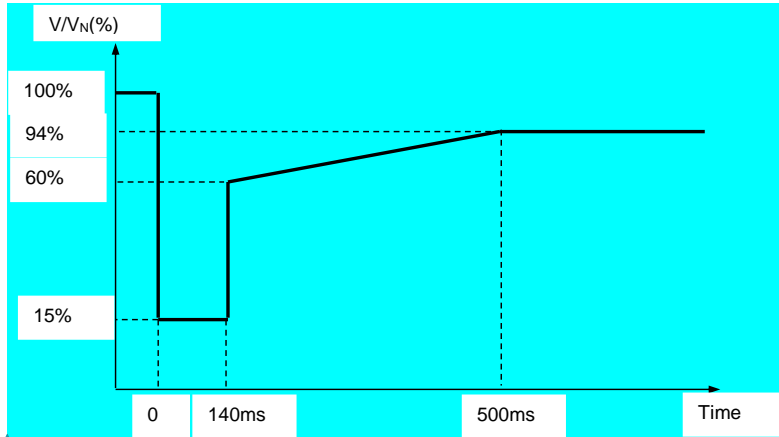

Figure 6

V/V_N is the ratio of the actual voltage on one or more phases at the LV Side of the Offshore Platform to the nominal voltage of the LV Side of the Offshore Platform.

- (ii) Each Offshore Generating Unit, or Offshore Power Park Module and any constituent Power Park Unit thereof shall provide Active Power output, during voltage dips on the LV Side of the Offshore Platform as described in Figure 6, at least in proportion to the retained voltage at the LV Side of the Offshore Platform except in the case of an Offshore Non-Synchronous Generating Unit or Offshore Power Park Module where there has been a reduction in the Intermittent Power Source in the time range in Figure 6 that restricts the Active Power output below this level and shall generate maximum reactive current without exceeding the transient rating limits of the Offshore Generating Unit or Offshore Power Park Module and any constituent Power Park Unit or, in the case of Plant and Apparatus installed on or after 1 December 2017, reactive compensation equipment. Once the Active Power output has been restored to the required level, Active Power oscillations shall be acceptable provided that:

- the total Active Energy delivered during the period of the oscillations is at least that which would have been delivered if the Active Power was constant
- the oscillations are adequately damped

and:

- (iii) Each Offshore DC Converter shall be designed to meet the Active Power recovery characteristics as specified in the Bilateral Agreement upon restoration of the voltage at the LV Side of the Offshore Platform.

(b) Requirements of Offshore Generating Units, Offshore Power Park Modules, to withstand voltage dips on the LV Side of the Offshore Platform greater than 140ms in duration.

(1b) Requirements applicable to Offshore Synchronous Generating Units to withstand voltage dips on the LV Side of the Offshore Platform greater than 140ms in duration.

In addition to the requirements of CC.6.3.15.2. (a) each Offshore Synchronous Generating Unit shall:

Formatted: Highlight

Formatted: Highlight

(i) remain transiently stable and connected to the System without tripping of any Offshore Synchronous Generating Unit for any balanced voltage dips on the LV side of the Offshore Platform and associated durations anywhere on or above the heavy black line shown in Figure 7a. Appendix 4B and Figures CC.A.4B.3.2 (a), (b) and (c) provide an explanation and illustrations of Figure 7a. It should be noted that in the case of an Offshore Synchronous Generating Unit which is connected to an Offshore Transmission System which includes a Transmission DC Converter as part of that Offshore Transmission System, the Offshore Grid Entry Point voltage may not indicate the presence of a voltage dip on the Onshore Transmission System. The voltage dip will affect the level of Active Power that can be transferred to the Onshore Transmission System and therefore subject the Offshore Generating Unit, to a load rejection.

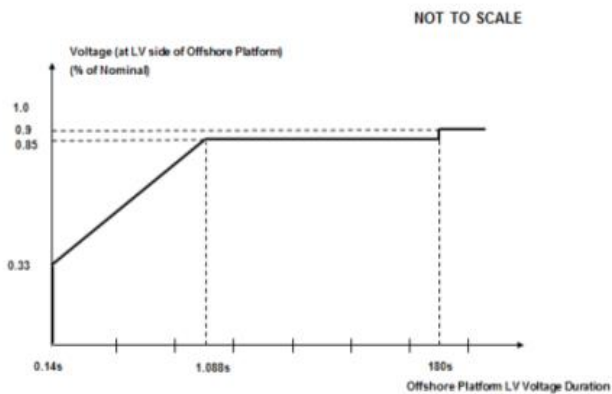

Formatted: Highlight

Formatted: Highlight

(ii) provide Active Power output, during voltage dips on the LV Side of the Offshore Platform as described in Figure 7a, at least in proportion to the retained balanced or unbalanced voltage at the LV Side of the Offshore Platform and shall generate maximum reactive current (where the voltage at the Offshore Grid Entry Point is outside the limits specified in CC.6.1.4) without exceeding the transient rating limits of the Offshore Synchronous Generating Unit and,

(iii) within 1 second of restoration of the voltage to 1.0p.u of the nominal voltage at the LV Side of the Offshore Platform, restore Active Power to at least 90% of the Offshore Synchronous Generating Unit's immediate pre-disturbed value, unless there has been a reduction in the Intermittent Power Source in the time range in Figure 7a that restricts the Active Power output below this level. Once the Active Power output has been restored to the required level, Active Power oscillations shall be acceptable provided that:

- the total Active Energy delivered during the period of the oscillations is at least that which would have been delivered if the Active Power was constant
- the oscillations are adequately damped

(2b) Requirements applicable to Offshore Power Park Modules to withstand voltage dips on the LV Side of the Offshore Platform greater than 140ms in duration.

In addition to the requirements of CC.6.3.15.2. (a) each **Offshore Power Park Module** and / or any constituent **Power Park Unit**, shall:

- (i) remain transiently stable and connected to the **System** without tripping of any **Offshore Power Park Module** and / or any constituent **Power Park Unit**, for any balanced voltage dips on the **LV side of the Offshore Platform** and associated durations anywhere on or above the heavy black line shown in Figure 7b. Appendix 4B and Figures CC.A.4B.5. (a), (b) and (c) provide an explanation and illustrations of Figure 7b. It should be noted that in the case of an **Offshore Power Park Module** (including any **Offshore Power Park Unit** thereof) which is connected to an **Offshore Transmission System** which includes a **Transmission DC Converter** as part of that **Offshore Transmission System**, the **Offshore Grid Entry Point** voltage may not indicate the presence of a voltage dip on the **Onshore Transmission System**. The voltage dip will affect the level of **Active Power** that can be transferred to the **Onshore Transmission System** and therefore subject the **Offshore Power Park Module** (including any **Offshore Power Park Unit** thereof) to a load rejection.

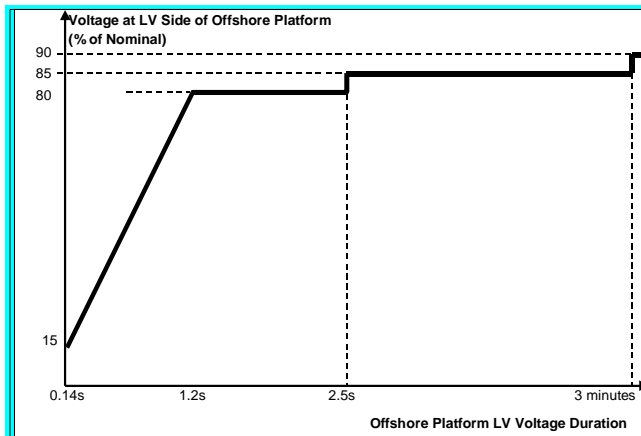

Figure 7b

- (ii) provide **Active Power** output, during voltage dips on the **LV Side of the Offshore Platform** as described in Figure 7b, at least in proportion to the retained balanced or unbalanced voltage at the **LV Side of the Offshore Platform** except in the case of an **Offshore Non-Synchronous Generating Unit** or **Offshore Power Park Module** where there has been a reduction in the **Intermittent Power Source** in the time range in Figure 7b that restricts the **Active Power** output below this level and shall generate maximum reactive current (where the voltage at the **Offshore Grid Entry Point** is outside the limits specified in CC.6.1.4) without exceeding the transient rating limits of the **Offshore Power Park Module** and any constituent **Power Park Unit** or reactive compensation equipment. For **Plant and Apparatus** installed on or after 1 December 2017, switched reactive compensation equipment (such as mechanically switched capacitors and reactors) shall be controlled such that it is not switched in or out of service during the fault but may act to assist in post fault voltage recovery; and,
- (iii) within 1 second of the restoration of the voltage at the **LV Side of the Offshore Platform** (to the minimum levels specified in CC.6.1.4) restore **Active Power** to at least 90% of the **Offshore Power Park Module's** immediate pre-disturbed value, unless there has been a reduction in the **Intermittent Power Source** in the time range in Figure 7b that restricts the **Active Power** output below this level. Once the **Active Power** output has been restored to the required level, **Active Power** oscillations shall be acceptable provided that:

Formatted: Highlight

- the total **Active Energy** delivered during the period of the oscillations is at least that which would have been delivered if the **Active Power** was constant
- the oscillations are adequately damped

CC.6.3.15.3 Other Requirements

- (i) In the case of a **Power Park Module** (comprising of wind-turbine generator units), the requirements in CC.6.3.15.1 and CC.6.3.15.2 do not apply when the **Power Park Module** is operating at less than 5% of its **Rated MW** or during very high wind speed conditions when more than 50% of the wind turbine generator units in a **Power Park Module** have been shut down or disconnected under an emergency shutdown sequence to protect **GB Code User's Plant and Apparatus**.
- (ii) In addition to meeting the conditions specified in CC.6.1.5(b) and CC.6.1.6, each **Non-Synchronous Generating Unit, OTSDUW Plant and Apparatus** or **Power Park Module** with a **Completion Date** after 1 April 2005 and any constituent **Power Park Unit** thereof will be required to withstand, without tripping, the negative phase sequence loading incurred by clearance of a close-up phase-to-phase fault, by **System Back-Up Protection** on the **Onshore Transmission System** operating at **Supergrid Voltage**.
- (iii) In the case of an **Onshore Power Park Module** in Scotland with a **Completion Date** before 1 January 2004 and a **Registered Capacity** less than 30MW the requirements in CC.6.3.15.1 (a) do not apply. In the case of an **Onshore Power Park Module** in Scotland with a **Completion Date** on or after 1 January 2004 and before 1 July 2005 and a **Registered Capacity** less than 30MW the requirements in CC.6.3.15.1 (a) are relaxed from the minimum **Onshore Transmission System Supergrid Voltage** of zero to a minimum **Onshore Transmission System Supergrid Voltage** of 15% of nominal. In the case of an **Onshore Power Park Module** in Scotland with a **Completion Date** before 1 January 2004 and a **Registered Capacity** of 30MW and above the requirements in CC.6.3.15.1 (a) are relaxed from the minimum **Onshore Transmission System Supergrid Voltage** of zero to a minimum **Onshore Transmission System Supergrid Voltage** of 15% of nominal.
- (iv) To avoid unwanted island operation, **Non-Synchronous Generating Units** in Scotland (and those directly connected to a **Scottish Offshore Transmission System**), **Power Park Modules** in Scotland (and those directly connected to a **Scottish Offshore Transmission System**), or **OTSDUW Plant and Apparatus** with an **Interface Point** in Scotland shall be tripped for the following conditions:
- (1) **Frequency** above 52Hz for more than 2 seconds
 - (2) **Frequency** below 47Hz for more than 2 seconds
 - (3) Voltage as measured at the **Onshore Connection Point** or **Onshore User System Entry Point** or **Offshore Grid Entry Point** or **Interface Point** in the case of **OTSDUW Plant and Apparatus** is below 80% for more than 2.5 seconds
 - (4) Voltage as measured at the **Onshore Connection Point** or **Onshore User System Entry Point** or **Offshore Grid Entry Point** or **Interface Point** in the case of **OTSDUW Plant and Apparatus** is above 120% (115% for 275kV) for more than 1 second.
- The times in sections (1) and (2) are maximum trip times. Shorter times may be used to protect the **Non-Synchronous Generating Units**, or **OTSDUW Plant and Apparatus** or **Power Park Modules**.

Additional Damping Control Facilities for DC Converters

- CC.6.3.16 (a) **DC Converter** owners, or **GB Generators** in respect of **OTSDUW DC Converters** or **Network Operators** in the case of an **Embedded DC Converter Station** not subject to a **Bilateral Agreement** must ensure that any of their **Onshore DC Converters** or **OTSDUW DC Converters** will not cause a sub-synchronous resonance problem on the **Total System**. Each **DC Converter** or **OTSDUW DC Converter** is required to be provided with sub-synchronous resonance damping control facilities.
- (b) Where specified in the **Bilateral Agreement**, each **DC Converter** or **OTSDUW DC Converter** is required to be provided with power oscillation damping or any other identified additional control facilities.

System to Generator Operational Intertripping Scheme

CC.6.3.17 **NGET** may require that a **System to Generator Operational Intertripping Scheme** be installed as part of a condition of the connection of the **GB Generator**. Scheme specific details shall be included in the relevant **Bilateral Agreement** and shall, in respect of **Bilateral Agreements** entered into on or after 16th March 2009 include the following information:

- (1) the relevant category(ies) of the scheme (referred to as Category 1 Intertripping Scheme, Category 2 Intertripping Scheme, Category 3 Intertripping Scheme and Category 4 Intertripping Scheme);
- (2) the **Generating Unit(s)** or **CCGT Module(s)** or **Power Park Module(s)** to be either permanently armed or that can be instructed to be armed in accordance with BC2.8;
- (3) the time within which the **Generating Unit(s)** or **CCGT Module(s)** or **Power Park Module(s)** circuit breaker(s) are to be automatically tripped;
- (4) the location to which the trip signal will be provided by **NGET**. Such location will be provided by **NGET** prior to the commissioning of the **Generating Unit(s)** or **CCGT Module(s)** or **Power Park Module(s)**.

Where applicable, the **Bilateral Agreement** shall include the conditions on the **National Electricity Transmission System** during which **NGET** may instruct the **System to Generator Operational Intertripping Scheme** to be armed and the conditions that would initiate a trip signal.

CC.6.3.18 The time within which the **Generating Unit(s)** or **CCGT Module** or **Power Park Module** circuit breaker(s) need to be automatically tripped is determined by the specific conditions local to the **GB Generator**. This 'time to trip' (defined as time from provision of the trip signal by **NGET** to the specified location, to circuit breaker main contact opening) can typically range from 100ms to 10sec. A longer time to trip may allow the initiation of an automatic reduction in the **Generating Unit(s)** or **CCGT Module(s)** or **Power Park Module(s)** output prior to the automatic tripping of the **Generating Unit(s)** or **CCGT Module(s)** or **Power Park Module(s)** circuit breaker. Where applicable **NGET** may provide separate trip signals to allow for either a longer or shorter 'time to trip' to be initiated.

CC.6.4 General Network Operator And Non-Embedded Customer Requirements

CC.6.4.1 This part of the **Grid Code** describes the technical and design criteria and performance requirements for **Network Operators** and **Non-Embedded Customers**.

Neutral Earthing

CC.6.4.2 At nominal **System** voltages of 132kV and above the higher voltage windings of three phase transformers and transformer banks connected to the **National Electricity Transmission System** must be star connected with the star point suitable for connection to earth. The earthing and lower voltage winding arrangement shall be such as to ensure that the **Earth Fault Factor** requirement of paragraph CC.6.2.1.1 (b) will be met on the **National Electricity Transmission System** at nominal **System** voltages of 132kV and above.

Frequency Sensitive Relays

CC.6.4.3 As explained under **OC6**, each **Network Operator**, will make arrangements that will facilitate automatic low **Frequency Disconnection of Demand** (based on **Annual ACS Conditions**). CC.A.5.5. of Appendix 5 includes specifications of the local percentage **Demand** that shall be disconnected at specific frequencies. The manner in which **Demand** subject to low **Frequency** disconnection will be split into discrete MW blocks is specified in OC6.6. Technical requirements relating to **Low Frequency Relays** are also listed in Appendix 5.

Operational Metering

CC.6.4.4 Where **NGET** can reasonably demonstrate that an **Embedded Medium Power Station** or **Embedded DC Converter Station** has a significant effect on the **National Electricity Transmission System**, it may require the **Network Operator** within whose **System** the **Embedded Medium Power Station** or **Embedded DC Converter Station** is situated to ensure that the operational metering equipment described in CC.6.5.6 is installed such that **NGET** can receive the data referred to in CC.6.5.6. In the case of an **Embedded Medium Power Station** subject to, or proposed to be subject to a **Bilateral Agreement** **NGET** shall notify such **Network Operator** of the details of such installation in writing within 3 months of being notified of the application to connect under **CUSC** and in the case of an **Embedded Medium Power Station** not subject to, or not proposed to be subject to a **Bilateral Agreement** in writing as a **Site Specific Requirement** in accordance with the timescales in CUSC 6.5.5. In either case the **Network Operator** shall ensure that the data referred to in CC.6.5.6 is provided to **NGET**.

CC.6.5 Communications Plant

CC.6.5.1 In order to ensure control of the **National Electricity Transmission System**, telecommunications between **GB Code Users** and **NGET** must (including in respect of any **OTSDUW Plant and Apparatus** at the **OTSUA Transfer Time**), if required by **NGET**, be established in accordance with the requirements set down below.

CC.6.5.2 Control Telephony and System Telephony

CC.6.5.2.1 **Control Telephony** is the principle method by which a **User's Responsible Engineer/Operator** and **NGET Control Engineers** speak to one another for the purposes of control of the **Total System** in both normal and emergency operating conditions. **Control Telephony** provides secure point to point telephony for routine **Control Calls**, priority **Control Calls** and emergency **Control Calls**.

CC.6.5.2.2 **System Telephony** is an alternate method by which a **User's Responsible Engineer/Operator** and **NGET Control Engineers** speak to one another for the purposes of control of the **Total System** in both normal operating conditions and where practicable, emergency operating conditions. **System Telephony** uses the Public Switched Telephony Network to provide telephony for **Control Calls**, inclusive of emergency **Control Calls**.

CC.6.5.2.3 Calls made and received over **Control Telephony** and **System Telephony** may be recorded and subsequently replayed for commercial and operational reasons.

CC.6.5.3 Supervisory Tones

CC.6.5.3.1 **Control Telephony** supervisory tones indicate to the calling and receiving parties dial engaged, ringing, secondary engaged (signifying that priority may be exercised) and priority disconnect tones.

Formatted: Highlight

- CC.6.5.3.2 **System Telephony** supervisory tones indicate to the calling and receiving parties dial, engaged and ringing tones.
- CC.6.5.4 **Obligations in respect of Control Telephony and System Telephony**
- CC.6.5.4.1 Where **NGET** requires **Control Telephony**, **Users** are required to use the **Control Telephony** with **NGET** in respect of all **Connection Points** with the **National Electricity Transmission System** and in respect of all **Embedded Large Power Stations** and **Embedded DC Converter Stations**. **NGET** will install **Control Telephony** at the **GB Code User's Control Point** where the **GB Code User's** telephony equipment is not capable of providing the required facilities or is otherwise incompatible with the **Transmission Control Telephony**. Details of and relating to the **Control Telephony** required are contained in the **Bilateral Agreement**.
- CC.6.5.4.2 Where in **NGET's** sole opinion the installation of **Control Telephony** is not practicable at a **GB Code User's Control Point(s)**, **NGET** shall specify in the **Bilateral Agreement** whether **System Telephony** is required. Where **System Telephony** is required by **NGET**, the **GB Code User** shall ensure that **System Telephony** is installed.
- CC.6.5.4.3 Where **System Telephony** is installed, **GB Code Users** are required to use the **System Telephony** with **NGET** in respect of those **Control Point(s)** for which it has been installed. Details of and relating to the **System Telephony** required are contained in the **Bilateral Agreement**.
- CC.6.5.4.4 Where **Control Telephony** or **System Telephony** is installed, routine testing of such facilities may be required by **NGET** (not normally more than once in any calendar month). The **GB Code User** and **NGET** shall use reasonable endeavours to agree a test programme and where **NGET** requests the assistance of the **GB Code User** in performing the agreed test programme the **User** shall provide such assistance.
- CC.6.5.4.5 **Control Telephony** and **System Telephony** shall only be used for the purposes of operational voice communication between **NGET** and the relevant **User**.
- CC.6.5.4.6 **Control Telephony** contains emergency calling functionality to be used for urgent operational communication only. Such functionality enables **NGET** and **Users** to utilise a priority call in the event of an emergency. **NGET** and **GB Code Users** shall only use such priority call functionality for urgent operational communications.
- CC.6.5.5 **Technical Requirements for Control Telephony and System Telephony**
- CC.6.5.5.1 Detailed information on the technical interfaces and support requirements for **Control Telephony** applicable in **NGET's Transmission Area** is provided in the **Control Telephony Electrical Standard** identified in the Annex to the **General Conditions**. Where additional information, or information in relation to **Control Telephony** applicable in Scotland, is requested by **GB Code Users**, this will be provided, where possible, by **NGET**.
- CC.6.5.5.2 **System Telephony** shall consist of a dedicated Public Switched Telephone Network telephone line that shall be installed and configured by the relevant **GB Code User**. **NGET** shall provide a dedicated free phone number (UK only), for the purposes of receiving incoming calls to **NGET**, which **GB Code Users** shall utilise for **System Telephony**. **System Telephony** shall only be utilised by the **NGET Control Engineer** and the **GB Code User's Responsible Engineer/Operator** for the purposes of operational communications.

Operational Metering

CC.6.5.6

(a) **NGET** shall provide system control and data acquisition (SCADA) outstation interface equipment. The **GB Code User** shall provide such voltage, current, **Frequency, Active Power and Reactive Power** measurement outputs and plant status indications and alarms to the **Transmission SCADA** outstation interface equipment as required by **NGET** in accordance with the terms of the **Bilateral Agreement**. In the case of **OTSDUW**, the **GB Code User** shall provide such SCADA outstation interface equipment and voltage, current, **Frequency, Active Power and Reactive Power** measurement outputs and plant status indications and alarms to the SCADA outstation interface equipment as required by **NGET** in accordance with the terms of the **Bilateral Agreement**.

(b) For the avoidance of doubt, for **Active Power and Reactive Power** measurements, circuit breaker and disconnector status indications from:

Formatted: Highlight

(i) **CCGT Modules at Large Power Stations**, the outputs and status indications must each be provided to **NGET** on an individual **CCGT Unit** basis. In addition, where identified in the **Bilateral Agreement**, **Active Power and Reactive Power** measurements from **Unit Transformers** and/or **Station Transformers** must be provided.

(ii) **DC Converters at DC Converter Stations and OTSDUW DC Converters**, the outputs and status indications must each be provided to **NGET** on an individual **DC Converter** basis. In addition, where identified in the **Bilateral Agreement**, **Active Power and Reactive Power** measurements from converter and/or station transformers must be provided.

(iii) **Power Park Modules at Embedded Large Power Stations** and at directly connected **Power Stations**, the outputs and status indications must each be provided to **NGET** on an individual **Power Park Module** basis. In addition, where identified in the **Bilateral Agreement**, **Active Power and Reactive Power** measurements from station transformers must be provided.

(iv) In respect of **OTSDUW Plant and Apparatus**, the outputs and status indications must be provided to **NGET** for each piece of electrical equipment. In addition, where identified in the **Bilateral Agreement**, **Active Power and Reactive Power** measurements at the **Interface Point** must be provided.

(c) For the avoidance of doubt, the requirements of CC.6.5.6(a) in the case of a **Cascade Hydro Scheme** will be provided for each **Generating Unit** forming part of that **Cascade Hydro Scheme**. In the case of **Embedded Generating Units** forming part of a **Cascade Hydro Scheme** the data may be provided by means other than a **NGET SCADA** outstation located at the **Power Station**, such as, with the agreement of the **Network Operator** in whose system such **Embedded Generating Unit** is located, from the **Network Operator's** SCADA system to **NGET**. Details of such arrangements will be contained in the relevant **Bilateral Agreements** between **NGET** and the **GB Generator** and the **Network Operator**.

(d) In the case of a **Power Park Module**, additional energy input signals (e.g. wind speed, and wind direction) may be specified in the **Bilateral Agreement**. For **Power Park Modules** with a **Completion Date** on or after 1st April 2016 a **Power Available** signal will also be specified in the **Bilateral Agreement**. The signals would be used to establish the potential level of energy input from the **Intermittent Power Source** for monitoring pursuant to CC.6.6.1 and **Ancillary Services** and will, in the case of a wind farm, be used to provide **NGET** with advanced warning of excess wind speed shutdown and to determine the level of **Headroom** available from **Power Park Modules** for the purposes of calculating response and reserve. For the avoidance of doubt, the **Power Available** signal would be automatically provided to **NGET** and represent the sum of the potential output of all available and operational **Power Park Units** within the **Power Park Module**. The refresh rate of the **Power Available** signal shall be specified in the **Bilateral Agreement**.

Instructor Facilities

Formatted: Highlight

CC.6.5.7 The **User** shall accommodate **Instructor Facilities** provided by **NGET** for the receipt of operational messages relating to **System** conditions.

Electronic Data Communication Facilities

CC.6.5.8 (a) All **BM Participants** must ensure that appropriate electronic data communication facilities are in place to permit the submission of data, as required by the **Grid Code**, to **NGET**.

(b) In addition,

(1) any **GB Code User** that wishes to participate in the **Balancing Mechanism**;

or

(2) any **BM Participant** in respect of its **BM Units** at a **Power Station** where the **Construction Agreement** and/or a **Bilateral Agreement** has a **Completion Date** on or after 1 January 2013 and the **BM Participant** is required to provide all **Part 1 System Ancillary Services** in accordance with CC.8.1 (unless **NGET** has otherwise agreed)

must ensure that appropriate automatic logging devices are installed at the **Control Points** of its **BM Units** to submit data to and to receive instructions from **NGET**, as required by the **Grid Code**. For the avoidance of doubt, in the case of an **Interconnector User** the **Control Point** will be at the **Control Centre** of the appropriate **Externally Interconnected System Operator**.

(c) Detailed specifications of these required electronic facilities will be provided by **NGET** on request and they are listed as **Electrical Standards** in the Annex to the **General Conditions**.

Facsimile Machines

CC.6.5.9 Each **GB Code User** and **NGET** shall provide a facsimile machine or machines:

(a) in the case of **GB Generators**, at the **Control Point** of each **Power Station** and at its **Trading Point**;

(b) in the case of **NGET** and **Network Operators**, at the **Control Centre(s)**; and

(c) in the case of **Non-Embedded Customers** and **DC Converter Station** owners at the **Control Point**.

Each **GB Code User** shall notify, prior to connection to the **System** of the **GB Code User's Plant and Apparatus**, **NGET** of its or their telephone number or numbers, and will notify **NGET** of any changes. Prior to connection to the **System** of the **GB Code User's Plant and Apparatus** **NGET** shall notify each **GB Code User** of the telephone number or numbers of its facsimile machine or machines and will notify any changes.

CC.6.5.10 Busbar Voltage

NGET shall, subject as provided below, provide each **GB Generator** or **DC Converter Station** owner at each **Grid Entry Point** where one of its **Power Stations** or **DC Converter Stations** is connected with appropriate voltage signals to enable the **GB Generator** or **DC Converter Station** owner to obtain the necessary information to permit its **Gensets** or **DC Converters** to be **Synchronised** to the **National Electricity Transmission System**. The term "voltage signal" shall mean in this context, a point of connection on (or wire or wires from) a relevant part of **Transmission Plant** and/or **Apparatus** at the **Grid Entry Point**, to which the **GB Generator** or **DC Converter Station** owner, with **NGET's** agreement (not to be unreasonably withheld) in relation to the **Plant** and/or **Apparatus** to be attached, will be able to attach its **Plant** and/or **Apparatus** (normally a wire or wires) in order to obtain measurement outputs in relation to the busbar.

CC.6.5.11 Bilingual Message Facilities

- (a) A Bilingual Message Facility is the method by which the **User's Responsible Engineer/Operator**, the **Externally Interconnected System Operator** and **NGET Control Engineers** communicate clear and unambiguous information in two languages for the purposes of control of the **Total System** in both normal and emergency operating conditions.
- (b) A Bilingual Message Facility, where required, will provide up to two hundred pre-defined messages with up to five hundred and sixty characters each. A maximum of one minute is allowed for the transmission to, and display of, the selected message at any destination. The standard messages must be capable of being displayed at any combination of locations and can originate from any of these locations. Messages displayed in the UK will be displayed in the English language.
- (c) Detailed information on a Bilingual Message Facility and suitable equipment required for individual **GB Code User** applications will be provided by **NGET** upon request.

CC.6.6 System Monitoring

CC.6.6.1 Monitoring equipment is provided on the **National Electricity Transmission System** to enable **NGET** to monitor its power system dynamic performance conditions. Where this monitoring equipment requires voltage and current signals on the **Generating Unit** (other than **Power Park Unit**), **DC Converter** or **Power Park Module** circuit from the **GB Code User** or from **OTSDUW Plant and Apparatus**, **NGET** will inform the **GB Code User** and they will be provided by the **GB Code User** with both the timing of the installation of the equipment for receiving such signals and its exact position being agreed (the **GB Code User's** agreement not to be unreasonably withheld) and the costs being dealt with, pursuant to the terms of the **Bilateral Agreement**.

CC.6.6.2 For all on site monitoring by **NGET** of witnessed tests pursuant to the **CP** or **OC5** the **GB Code User** shall provide suitable test signals as outlined in **OC5.A.1**.

CC.6.6.2.1 The signals which shall be provided by the **GB Code User** to **NGET** for onsite monitoring shall be of the following resolution, unless otherwise agreed by **NGET**:

- (i) 1 Hz for reactive range tests
- (ii) 10 Hz for frequency control tests
- (iii) 100 Hz for voltage control tests

CC.6.6.2.2 The **GB Code User** will provide all relevant signals for this purpose in the form of d.c. voltages within the range -10V to +10V. In exceptional circumstances some signals may be accepted as d.c. voltages within the range -60V to +60V with prior agreement between the **GB Code User** and **NGET**. All signals shall:

- (i) in the case of an **Onshore Power Park Module**, **DC Converter Station** or **Synchronous Generating Unit**, be suitably terminated in a single accessible location at the **GB Generator** or **DC Converter Station** owner's site.
- (ii) in the case of an **Offshore Power Park Module** and **OTSDUW Plant and Apparatus**, be transmitted onshore without attenuation, delay or filtering which would result in the inability to fully demonstrate the objectives of the test, or identify any potential safety or plant instability issues, and be suitably terminated in a single robust location normally located at or near the onshore **Interface Point** of the **Offshore Transmission System** to which it is connected.

CC.6.6.2.3 All signals shall be suitably scaled across the range. The following scaling would (unless **NGET** notify the **GB Code User** otherwise) be acceptable to **NGET**:

- (a) 0MW to **Registered Capacity** or **Interface Point Capacity** 0-8V dc
- (b) Maximum leading **Reactive Power** to maximum lagging **Reactive Power** -8 to 8V dc
- (c) 48 – 52Hz as -8 to 8V dc
- (d) Nominal terminal or connection point voltage -10% to +10% as -8 to 8V dc

CC.6.6.2.4 The **GB Code User** shall provide to **NGET** a 230V power supply adjacent to the signal terminal location.

CC.7 SITE RELATED CONDITIONS

CC.7.1 Not used.

CC.7.2 Responsibilities For Safety

CC.7.2.1 In England and Wales, any **User** entering and working on its **Plant** and/or **Apparatus** (including, until the **OTSUA Transfer Time**, any **OTSUA**) on a **Transmission Site** will work to the **Safety Rules** of **NGET**.

In Scotland or **Offshore**, any **User** entering and working on its **Plant** and/or **Apparatus** (including, until the **OTSUA Transfer Time**, any **OTSUA**) on a **Transmission Site** will work to the **Safety Rules** of the **Relevant Transmission Licensee**, as advised by **NGET**.

CC.7.2.2 **NGET** entering and working on **Transmission Plant** and/or **Apparatus** on a **User Site** will work to the **User's Safety Rules**. For **User Sites** in Scotland or **Offshore**, **NGET** shall procure that the **Relevant Transmission Licensee** entering and working on **Transmission Plant** and/or **Apparatus** on a **User Site** will work to the **User's Safety Rules**.

CC.7.2.3 A **User** may, with a minimum of six weeks notice, apply to **NGET** for permission to work according to that **Users** own **Safety Rules** when working on its **Plant** and/or **Apparatus** on a **Transmission Site** rather than those set out in CC.7.2.1. If **NGET** is of the opinion that the **User's Safety Rules** provide for a level of safety commensurate with those set out in CC.7.2.1, **NGET** will notify the **User**, in writing, that, with effect from the date requested by the **User**, the **User** may use its own **Safety Rules** when working on its **Plant** and/or **Apparatus** on the **Transmission Site**. For a **Transmission Site** in Scotland or **Offshore**, in forming its opinion, **NGET** will seek the opinion of the **Relevant Transmission Licensee**. Until receipt of such written approval from **NGET**, the **GB Code User** will continue to use the **Safety Rules** as set out in CC.7.2.1.

CC.7.2.4 In the case of a **User Site** in England and Wales, **NGET** may, with a minimum of six weeks notice, apply to a **User** for permission to work according to **NGET's Safety Rules** when working on **Transmission Plant** and/or **Apparatus** on that **User Site**, rather than the **User's Safety Rules**. If the **User** is of the opinion that **NGET's Safety Rules** provide for a level of safety commensurate with that of that **User's Safety Rules**, it will notify **NGET**, in writing, that, with the effect from the date requested by **NGET**, **NGET** may use its own **Safety Rules** when working on its **Transmission Plant** and/or **Apparatus** on that **User Site**. Until receipt of such written approval from the **User**, **NGET** shall continue to use the **User's Safety Rules**.

In the case of a **User Site** in Scotland or **Offshore**, **NGET** may, with a minimum of six weeks notice, apply to a **User** for permission for the **Relevant Transmission Licensee** to work according to the **Relevant Transmission Licensee's Safety Rules** when working on **Transmission Plant** and/or **Apparatus** on that **User Site**, rather than the **User's Safety Rules**. If the **User** is of the opinion that the **Relevant Transmission Licensee's Safety Rules**, provide for a level of safety commensurate with that of that **User's Safety Rules**, it will notify **NGET**, in writing, that, with effect from the date requested by **NGET**, that the **Relevant Transmission Licensee** may use its own **Safety Rules** when working on its **Transmission Plant** and/or **Apparatus** on that **User's Site**. Until receipt of such written approval from the **User**, **NGET** shall procure that the **Relevant Transmission Licensee** shall continue to use the **User's Safety Rules**.

Formatted: Highlight

Formatted: Highlight

Formatted: Highlight

Formatted: Highlight

Formatted: Highlight

CC.7.2.5 For a **Transmission Site** in England and Wales, if **NGET** gives its approval for the **User's Safety Rules** to apply to the **User** when working on its **Plant** and/or **Apparatus**, that does not imply that the **User's Safety Rules** will apply to entering the **Transmission Site** and access to the **User's Plant** and/or **Apparatus** on that **Transmission Site**. Bearing in mind **NGET's** responsibility for the whole **Transmission Site**, entry and access will always be in accordance with **NGET's** site access procedures. For a **User Site** in England and Wales, if the **User** gives its approval for **NGET's Safety Rules** to apply to **NGET** when working on its **Plant** and **Apparatus**, that does not imply that **NGET's Safety Rules** will apply to entering the **User Site**, and access to the **Transmission Plant** and **Apparatus** on that **User Site**. Bearing in mind the **User's** responsibility for the whole **User Site**, entry and access will always be in accordance with the **User's** site access procedures.

For a **Transmission Site** in Scotland or **Offshore**, if **NGET** gives its approval for the **User's Safety Rules** to apply to the **User** when working on its **Plant** and/or **Apparatus**, that does not imply that the **User's Safety Rules** will apply to entering the **Transmission Site** and access to the **User's Plant** and/or **Apparatus** on that **Transmission Site**. Bearing in mind the **Relevant Transmission Licensee's** responsibility for the whole **Transmission Site**, entry and access will always be in accordance with the **Relevant Transmission Licensee's** site access procedures. For a **User Site** in Scotland or **Offshore**, if the **User** gives its approval for **Relevant Transmission Licensee Safety Rules** to apply to the **Relevant Transmission Licensee** when working on its **Plant** and **Apparatus**, that does not imply that the **Relevant Transmission Licensee's Safety Rules** will apply to entering the **User Site**, and access to the **Transmission Plant** and **Apparatus** on that **User Site**. Bearing in mind the **User's** responsibility for the whole **User Site**, entry and access will always be in accordance with the **User's** site access procedures.

CC.7.2.6 For **User Sites** in England and Wales, **Users** shall notify **NGET** of any **Safety Rules** that apply to **NGET's** staff working on **User Sites**. For **Transmission Sites** in England and Wales, **NGET** shall notify **Users** of any **Safety Rules** that apply to the **User's** staff working on the **Transmission Site**.

For **User Sites** in Scotland or **Offshore**, **Users** shall notify **NGET** of any **Safety Rules** that apply to the **Relevant Transmission Licensee's** staff working on **User Sites**. For **Transmission Sites** in Scotland or **Offshore** **NGET** shall procure that the **Relevant Transmission Licensee** shall notify **Users** of any **Safety Rules** that apply to the **User's** staff working on the **Transmission Site**.

CC.7.2.7 Each **Site Responsibility Schedule** must have recorded on it the **Safety Rules** which apply to each item of **Plant** and/or **Apparatus**.

CC.7.2.8 In the case of **OTSUA** a **User Site** or **Transmission Site** shall, for the purposes of this CC.7.2, include a site at which there is an **Interface Point** until the **OTSUA Transfer Time** when it becomes part of the **National Electricity Transmission System**.

CC.7.3 Site Responsibility Schedules

CC.7.3.1 In order to inform site operational staff and **NGET Control Engineers** of agreed responsibilities for **Plant** and/or **Apparatus** at the operational interface, a **Site Responsibility Schedule** shall be produced for **Connection Sites** (and in the case of **OTSUA**, until the **OTSUA Transfer Time, Interface Sites**) in England and Wales for **NGET** and **Users** with whom they interface, and for **Connection Sites** (and in the case of **OTSUA**, until the **OTSUA Transfer Time, Interface Sites**) in Scotland or **Offshore** for **NGET**, the **Relevant Transmission Licensee** and **Users** with whom they interface.

CC.7.3.2 The format, principles and basic procedure to be used in the preparation of **Site Responsibility Schedules** are set down in Appendix 1.

CC.7.4 Operation And Gas Zone Diagrams

Operation Diagrams

CC.7.4.1 An **Operation Diagram** shall be prepared for each **Connection Site** at which a **Connection Point** exists (and in the case of **OTSDUW Plant and Apparatus**, by **User's** for each **Interface Point**) using, where appropriate, the graphical symbols shown in Part 1A of Appendix 2. **Users** should also note that the provisions of **OC11** apply in certain circumstances.

CC.7.4.2 The **Operation Diagram** shall include all **HV Apparatus** and the connections to all external circuits and incorporate numbering, nomenclature and labelling, as set out in **OC11**. At those **Connection Sites** (or in the case of **OTSDUW Plant and Apparatus, Interface Points**) where gas-insulated metal enclosed switchgear and/or other gas-insulated **HV Apparatus** is installed, those items must be depicted within an area delineated by a chain dotted line which intersects gas-zone boundaries. The nomenclature used shall conform with that used on the relevant **Connection Site** and circuit (and in the case of **OTSDUW Plant and Apparatus, Interface Point** and circuit). The **Operation Diagram** (and the list of technical details) is intended to provide an accurate record of the layout and circuit interconnections, ratings and numbering and nomenclature of **HV Apparatus** and related **Plant**.

CC.7.4.3 A non-exhaustive guide to the types of **HV Apparatus** to be shown in the **Operation Diagram** is shown in Part 2 of Appendix 2, together with certain basic principles to be followed unless equivalent principles are approved by **NGET**.

Gas Zone Diagrams

CC.7.4.4 A **Gas Zone Diagram** shall be prepared for each **Connection Site** at which a **Connection Point** (and in the case of **OTSDUW Plant and Apparatus**, by **User's** for an **Interface Point**) exists where gas-insulated switchgear and/or other gas-insulated **HV Apparatus** is utilised. They shall use, where appropriate, the graphical symbols shown in Part 1B of Appendix 2.

CC.7.4.5 The nomenclature used shall conform with that used in the relevant **Connection Site** and circuit (and in the case of **OTSDUW Plant and Apparatus**, relevant **Interface Point** and circuit).

CC.7.4.6 The basic principles set out in Part 2 of Appendix 2 shall be followed in the preparation of **Gas Zone Diagrams** unless equivalent principles are approved by **NGET**.

Preparation of Operation and Gas Zone Diagrams for Users' Sites and Transmission Interface Sites

CC.7.4.7 In the case of a **User Site**, the **User** shall prepare and submit to **NGET**, an **Operation Diagram** for all **HV Apparatus** on the **User** side of the **Connection Point** (and in the case of **OTSDUW Plant and Apparatus**, on what will be the **Offshore Transmission** side of the **Connection Point** and the **Interface Point**) and **NGET** shall provide the **User** with an **Operation Diagram** for all **HV Apparatus** on the **Transmission** side of the **Connection Point** (and in the case of **OTSDUW Plant and Apparatus** on what will be the **Onshore Transmission** side of the **Interface Point**, in accordance with the timing requirements of the **Bilateral Agreement** and/or **Construction Agreement** prior to the **Completion Date** under the **Bilateral Agreement** and/or **Construction Agreement**.

CC.7.4.8 The **User** will then prepare, produce and distribute, using the information submitted on the **User's Operation Diagram** and **NGET Operation Diagram**, a composite **Operation Diagram** for the complete **Connection Site** (and in the case of **OTSDUW Plant and Apparatus, Interface Point**), also in accordance with the timing requirements of the **Bilateral Agreement** and/or **Construction Agreement**.

CC.7.4.9 The provisions of CC.7.4.7 and CC.7.4.8 shall apply in relation to **Gas Zone Diagrams** where gas-insulated switchgear and/or other gas-insulated **HV Apparatus** is utilised.

Preparation of Operation and Gas Zone Diagrams for Transmission Sites

CC.7.4.10 In the case of an **Transmission Site**, the **User** shall prepare and submit to **NGET** an **Operation Diagram** for all **HV Apparatus** on the **User** side of the **Connection Point**, in accordance with the timing requirements of the **Bilateral Agreement** and/or **Construction Agreement**.

CC.7.4.11 NGET will then prepare, produce and distribute, using the information submitted on the **User's Operation Diagram**, a composite **Operation Diagram** for the complete **Connection Site**, also in accordance with the timing requirements of the **Bilateral Agreement** and/or **Construction Agreement**.

CC.7.4.12 The provisions of CC.7.4.10 and CC.7.4.11 shall apply in relation to **Gas Zone Diagrams** where gas-insulated switchgear and/or other gas-insulated **HV Apparatus** is utilised.

CC.7.4.13 **Changes to Operation and Gas Zone Diagrams**

CC.7.4.13.1 When NGET has decided that it wishes to install new **HV Apparatus** or it wishes to change the existing numbering or nomenclature of **Transmission HV Apparatus** at a **Transmission Site**, NGET will (unless it gives rise to a **Modification** under the **CUSC**, in which case the provisions of the **CUSC** as to the timing apply) one month prior to the installation or change, send to each such **User** a revised **Operation Diagram** of that **Transmission Site**, incorporating the new **Transmission HV Apparatus** to be installed and its numbering and nomenclature or the changes, as the case may be. **OC11** is also relevant to certain **Apparatus**.

CC.7.4.13.2 When a **User** has decided that it wishes to install new **HV Apparatus**, or it wishes to change the existing numbering or nomenclature of its **HV Apparatus** at its **User Site**, the **User** will (unless it gives rise to a **Modification** under the **CUSC**, in which case the provisions of the **CUSC** as to the timing apply) one month prior to the installation or change, send to NGET a revised **Operation Diagram** of that **User Site** incorporating the new **User HV Apparatus** to be installed and its numbering and nomenclature or the changes as the case may be. **OC11** is also relevant to certain **Apparatus**.

CC.7.4.13.3 The provisions of CC.7.4.13.1 and CC.7.4.13.2 shall apply in relation to **Gas Zone Diagrams** where gas-insulated switchgear and/or other gas-insulated **HV Apparatus** is installed.

Validity

CC.7.4.14 (a) The composite **Operation Diagram** prepared by NGET or the **User**, as the case may be, will be the definitive **Operation Diagram** for all operational and planning activities associated with the **Connection Site**. If a dispute arises as to the accuracy of the composite **Operation Diagram**, a meeting shall be held at the **Connection Site**, as soon as reasonably practicable, between NGET and the **User**, to endeavour to resolve the matters in dispute.

(b) The composite **Operation Diagram** prepared by NGET or the **User**, as the case may be, will be the definitive **Operation Diagram** for all operational and planning activities associated with the **Interface Point** until the **OTSUA Transfer Time**. If a dispute arises as to the accuracy of the composite **Operation Diagram** prior to the **OTSUA Transfer Time**, a meeting shall be held at the **Interface Point**, as soon as reasonably practicable, between NGET and the **User**, to endeavour to resolve the matters in dispute.

(c) An equivalent rule shall apply for **Gas Zone Diagrams** where they exist for a **Connection Site**.

CC.7.4.15 In the case of **OTSUA**, a **User Site** and **Transmission Site** shall, for the purposes of this CC.7.4, include a site at which there is an **Interface Point** until the **OTSUA Transfer Time** when it becomes part of the **National Electricity Transmission System** and references to **HV Apparatus** in this CC.7.4 shall include references to **HV OTSUA**.

CC.7.5 **Site Common Drawings**

CC.7.5.1 **Site Common Drawings** will be prepared for each **Connection Site** (and in the case of **OTSDUW**, each **Interface Point**) and will include **Connection Site** (and in the case of **OTSDUW**, **Interface Point**) layout drawings, electrical layout drawings, common **Protection/control** drawings and common services drawings.

Preparation of Site Common Drawings for a User Site and Transmission Interface Site

CC.7.5.2 In the case of a **User Site**, **NGET** shall prepare and submit to the **User**, **Site Common Drawings** for the **Transmission** side of the **Connection Point** (and in the case of **OTSDUW Plant and Apparatus**, on what will be the **Onshore Transmission** side of the **Interface Point**.) and the **User** shall prepare and submit to **NGET**, **Site Common Drawings** for the **User** side of the **Connection Point** (and in the case of **OTSDUW**, on what will be the **Offshore Transmission** side of the **Interface Point**) in accordance with the timing requirements of the **Bilateral Agreement** and/or **Construction Agreement**.

CC.7.5.3 The **User** will then prepare, produce and distribute, using the information submitted on the **Transmission Site Common Drawings**, **Site Common Drawings** for the complete **Connection Site** (and in the case of **OTSDUW**, **Interface Point**) in accordance with the timing requirements of the **Bilateral Agreement** and/or **Construction Agreement**.

Preparation of Site Common Drawings for a Transmission Site

CC.7.5.4 In the case of a **Transmission Site**, the **User** will prepare and submit to **NGET** **Site Common Drawings** for the **User** side of the **Connection Point** in accordance with the timing requirements of the **Bilateral Agreement** and/or **Construction Agreement**.

CC.7.5.5 **NGET** will then prepare, produce and distribute, using the information submitted in the **User's Site Common Drawings**, **Site Common Drawings** for the complete **Connection Site** in accordance with the timing requirements of the **Bilateral Agreement** and/or **Construction Agreement**.

CC.7.5.6 When a **User** becomes aware that it is necessary to change any aspect of the **Site Common Drawings** at a **Connection Site** (and in the case of **OTSDUW**, **Interface Point**) it will:

- (a) if it is a **User Site**, as soon as reasonably practicable, prepare, produce and distribute revised **Site Common Drawings** for the complete **Connection Site** (and in the case of **OTSDUW**, **Interface Point**); and
- (b) if it is a **Transmission Site**, as soon as reasonably practicable, prepare and submit to **NGET** revised **Site Common Drawings** for the **User** side of the **Connection Point** (and in the case of **OTSDUW**, **Interface Point**) and **NGET** will then, as soon as reasonably practicable, prepare, produce and distribute, using the information submitted in the **User's Site Common Drawings**, revised **Site Common Drawings** for the complete **Connection Site** (and in the case of **OTSDUW**, **Interface Point**).

In either case, if in the **User's** reasonable opinion the change can be dealt with by it notifying **NGET** in writing of the change and for each party to amend its copy of the **Site Common Drawings** (or where there is only one set, for the party holding that set to amend it), then it shall so notify and each party shall so amend. If the change gives rise to a **Modification** under the **CUSC**, the provisions of the **CUSC** as to timing will apply.

CC.7.5.7 When **NGET** becomes aware that it is necessary to change any aspect of the **Site Common Drawings** at a **Connection Site**(and in the case of **OTSDUW**, **Interface Point**) it will:

- (a) if it is a **Transmission Site**, as soon as reasonably practicable, prepare, produce and distribute revised **Site Common Drawings** for the complete **Connection Site** (and in the case of **OTSDUW**, **Interface Point**); and
- (b) if it is a **User Site**, as soon as reasonably practicable, prepare and submit to the **User** revised **Site Common Drawings** for the **Transmission** side of the **Connection Point** (in the case of **OTSDUW**, **Interface Point**) and the **User** will then, as soon as reasonably practicable, prepare, produce and distribute, using the information submitted in the **Transmission Site Common Drawings**, revised **Site Common Drawings** for the complete **Connection Site** (and in the case of **OTSDUW**, **Interface Point**).

In either case, if in **NGET's** reasonable opinion the change can be dealt with by it notifying the **User** in writing of the change and for each party to amend its copy of the **Site Common Drawings** (or where there is only one set, for the party holding that set to amend it), then it shall so notify and each party shall so amend. If the change gives rise to a **Modification** under the **CUSC**, the provisions of the **CUSC** as to timing will apply.

Validity

CC.7.5.8 (a) The **Site Common Drawings** for the complete **Connection Site** prepared by the **User** or **NGET**, as the case may be, will be the definitive **Site Common Drawings** for all operational and planning activities associated with the **Connection Site**. If a dispute arises as to the accuracy of the **Site Common Drawings**, a meeting shall be held at the **Site**, as soon as reasonably practicable, between **NGET** and the **User**, to endeavour to resolve the matters in dispute.

(b) The **Site Common Drawing** prepared by **NGET** or the **User**, as the case may be, will be the definitive **Site Common Drawing** for all operational and planning activities associated with the **Interface Point** until the **OTSUA Transfer Time**. If a dispute arises as to the accuracy of the composite **Operation Diagram** prior to the **OTSUA Transfer Time**, a meeting shall be held at the **Interface Point**, as soon as reasonably practicable, between **NGET** and the **User**, to endeavour to resolve the matters in dispute.

CC.7.5.9 In the case of **OTSUA**, a **User Site** and **Transmission Site** shall, for the purposes of this CC.7.5, include a site at which there is an **Interface Point** until the **OTSUA Transfer Time** when it becomes part of the **National Electricity Transmission System**.

CC.7.6 Access

CC.7.6.1 The provisions relating to access to **Transmission Sites** by **Users**, and to **Users' Sites** by **Transmission Licensees**, are set out in each **Interface Agreement** (or in the case of **Interfaces Sites** prior to the **OTSUA Transfer Time** agreements in similar form) with, for **Transmission Sites** in England and Wales, **NGET** and each **User**, and for **Transmission Sites** in Scotland and **Offshore**, the **Relevant Transmission Licensee** and each **User**.

CC.7.6.2 In addition to those provisions, where a **Transmission Site** in England and Wales contains exposed **HV** conductors, unaccompanied access will only be granted to individuals holding an **Authority for Access** issued by **NGET** and where a **Transmission Site** in Scotland or **Offshore** contains exposed **HV** conductors, unaccompanied access will only be granted to individuals holding an **Authority for Access** issued by the **Relevant Transmission Licensee**.

CC.7.6.3 The procedure for applying for an **Authority for Access** is contained in the **Interface Agreement**.

CC.7.7 Maintenance Standards

CC.7.7.1 It is the **User's** responsibility to ensure that all its **Plant** and **Apparatus** (including, until the **OTSUA Transfer Time**, any **OTSUA**) on a **Transmission Site** is tested and maintained adequately for the purpose for which it is intended, and to ensure that it does not pose a threat to the safety of any **Transmission Plant, Apparatus** or personnel on the **Transmission Site**. **NGET** will have the right to inspect the test results and maintenance records relating to such **Plant** and **Apparatus** at any time.

CC.7.7.2 For **User Sites** in England and Wales, **NGET** has a responsibility to ensure that all **Transmission Plant** and **Apparatus** on a **User Site** is tested and maintained adequately for the purposes for which it is intended and to ensure that it does not pose a threat to the safety of any **User's Plant, Apparatus** or personnel on the **User Site**.

For **User Sites** in Scotland and **Offshore**, **NGET** shall procure that the **Relevant Transmission Licensee** has a responsibility to ensure that all **Transmission Plant** and **Apparatus** on a **User Site** is tested and maintained adequately for the purposes for which it is intended and to ensure that it does not pose a threat to the safety of any **User's Plant, Apparatus** or personnel on the **User Site**.

The **User** will have the right to inspect the test results and maintenance records relating to such **Plant** and **Apparatus** on its **User Site** at any time.

CC.7.8 Site Operational Procedures

CC.7.8.1 **NGET and Users** with an interface with **NGET**, must make available staff to take necessary **Safety Precautions** and carry out operational duties as may be required to enable work/testing to be carried out and for the operation of **Plant** and **Apparatus** (including, prior to the **OTSUA Transfer Time**, any **OTSUA**) connected to the **Total System**.

CC.7.9 **GB Generators** and **DC Converter Station** owners shall provide a **Control Point** in respect of each **Power Station** directly connected to the **National Electricity Transmission System** and **Embedded Large Power Station** or **DC Converter Station** to receive an act upon instructions pursuant to OC7 and BC2 at all times that **Generating Units** or **Power Park Modules** at the **Power Station** are generating or available to generate or **DC Converters** at the **DC Converter Station** are importing or exporting or available to do so. The **Control Point** shall be continuously manned except where the **Bilateral Agreement** in respect of such **Embedded Power Station** specifies that compliance with BC2 is not required, where the **Control Point** shall be manned between the hours of 0800 and 1800 each day.

CC.8 **ANCILLARY SERVICES**

CC.8.1 **System Ancillary Services**

The **CC** contain requirements for the capability for certain **Ancillary Services**, which are needed for **System** reasons ("**System Ancillary Services**"). There follows a list of these **System Ancillary Services**, together with the paragraph number of the **CC** (or other part of the **Grid Code**) in which the minimum capability is required or referred to. The list is divided into two categories: Part 1 lists the **System Ancillary Services** which

- (a) **GB Generators** in respect of **Large Power Stations** are obliged to provide (except **GB Generators** in respect of **Large Power Stations** which have a **Registered Capacity** of less than 50MW and comprise **Power Park Modules**); and,
- (b) **GB Generators** in respect of **Large Power Stations** with a **Registered Capacity** of less than 50MW and comprise **Power Park Modules** are obliged to provide in respect of **Reactive Power** only; and,
- (c) **DC Converter Station** owners are obliged to have the capability to supply; and
- (d) **GB Generators** in respect of **Medium Power Stations** (except **Embedded Medium Power Stations**) are obliged to provide in respect of **Reactive Power** only;

and Part 2 lists the **System Ancillary Services** which **GB Generators** will provide only if agreement to provide them is reached with **NGET**:

Part 1

- (a) **Reactive Power** supplied (in accordance with CC.6.3.2) otherwise than by means of synchronous or static compensators (except in the case of a **Power Park Module** where synchronous or static compensators within the **Power Park Module** may be used to provide **Reactive Power**)
- (b) **Frequency** Control by means of **Frequency** sensitive generation - CC.6.3.7 and BC3.5.1

Part 2

- (c) **Frequency** Control by means of **Fast Start** - CC.6.3.14
- (d) **Black Start Capability** - CC.6.3.5
- (e) **System to Generator Operational Intertipping**

Formatted: Highlight

Formatted: Highlight

Formatted: Highlight

Formatted: Highlight

CC.8.2 Commercial Ancillary Services

Other **Ancillary Services** are also utilised by **NGET** in operating the **Total System** if these have been agreed to be provided by a **GB Code User** (or other person) under an **Ancillary Services Agreement** or under a **Bilateral Agreement**, with payment being dealt with under an **Ancillary Services Agreement** or in the case of **Externally Interconnected System Operators** or **Interconnector Users**, under any other agreement (and in the case of **Externally Interconnected System Operators** and **Interconnector Users** includes ancillary services equivalent to or similar to **System Ancillary Services**) ("**Commercial Ancillary Services**"). The capability for these **Commercial Ancillary Services** is set out in the relevant **Ancillary Services Agreement** or **Bilateral Agreement** (as the case may be).

APPENDIX 1 - SITE RESPONSIBILITY SCHEDULES

FORMAT, PRINCIPLES AND BASIC PROCEDURE TO BE USED IN THE PREPARATION OF SITE RESPONSIBILITY SCHEDULES

Formatted: Highlight

Formatted: Highlight

Formatted: Highlight

Formatted: Highlight

CC.A.1.1 Principles

Types of Schedules

CC.A.1.1.1 At all **Complexes** (which in the context of this CC shall include, **Interface Sites** until the **OTSUA Transfer Time**) the following **Site Responsibility Schedules** shall be drawn up using the relevant proforma attached or with such variations as may be agreed between **NGET** and **Users**, but in the absence of agreement the relevant proforma attached will be used. In addition, in the case of **OTSDUW Plant and Apparatus**, and in readiness for the **OTSUA Transfer Time**, the **User** shall provide **NGET** with the necessary information such that **Site Responsibility Schedules** in this form can be prepared by the **Relevant Transmission Licensees** for the **Transmission Interface Site**:

- (a) Schedule of **HV Apparatus**
- (b) Schedule of **Plant, LV/MV Apparatus**, services and supplies;
- (c) Schedule of telecommunications and measurements **Apparatus**.

Other than at **Generating Unit, DC Converter, Power Park Module** and **Power Station** locations, the schedules referred to in (b) and (c) may be combined.

New Connection Sites

CC.A.1.1.2 In the case of a new **Connection Site** each **Site Responsibility Schedule** for a **Connection Site** shall be prepared by **NGET** in consultation with relevant **GB Code Users** at least 2 weeks prior to the **Completion Date** (or, where the **OTSUA** is to become **Operational** prior to the **OTSUA Transfer Time**, an alternative date) under the **Bilateral Agreement** and/or **Construction Agreement** for that **Connection Site** (which may form part of a **Complex**). In the case of a new **Interface Site** where the **OTSUA** is to become **Operational** prior to the **OTSUA Transfer Time** each **Site Responsibility Schedule** for an **Interface Site** shall be prepared by **NGET** in consultation with relevant **GB Code Users** at least 2 weeks prior to the **Completion Date** under the **Bilateral Agreement** and/or **Construction Agreement** for that **Interface Site** (which may form part of a **Complex**) (and references to and requirements placed on "**Connection Site**" in this CC shall also be read as "**Interface Site**" where the context requires and until the **OTSUA Transfer Time**). Each **GB Code User** shall, in accordance with the timing requirements of the **Bilateral Agreement** and/or **Construction Agreement**, provide information to **NGET** to enable it to prepare the **Site Responsibility Schedule**.

Sub-division

CC.A.1.1.3 Each **Site Responsibility Schedule** will be subdivided to take account of any separate **Connection Sites** on that **Complex**.

Scope

CC.A.1.1.4 Each **Site Responsibility Schedule** shall detail for each item of **Plant and Apparatus**:

- (a) **Plant/Apparatus** ownership;
- (b) **Site Manager (Controller)** (except in the case of **Plant/Apparatus** located in **SPT's Transmission Area**);
- (c) **Safety issues** comprising applicable **Safety Rules** and **Control Person** or other responsible person (**Safety Co-ordinator**), or such other person who is responsible for **safety**;
- (d) **Operations issues** comprising applicable **Operational Procedures** and control **engineer**;

(e) Responsibility to undertake statutory inspections, fault investigation and maintenance.

Each **Connection Point** shall be precisely shown.

Detail

CC.A.1.1.5 (a) In the case of **Site Responsibility Schedules** referred to in CC.A.1.1.1(b) and (c), with the exception of **Protection Apparatus** and **Intertrip Apparatus** operation, it will be sufficient to indicate the responsible **User** or **Transmission Licensee**, as the case may be.

(b) In the case of the **Site Responsibility Schedule** referred to in CC.A.1.1.1(a) and for **Protection Apparatus** and **Intertrip Apparatus**, the responsible management unit must be shown in addition to the **User** or **Transmission Licensee**, as the case may be.

CC.A.1.1.6 The **HV Apparatus Site Responsibility Schedule** for each **Connection Site** must include lines and cables emanating from or traversing¹ the **Connection Site**.

Issue Details

CC.A.1.1.7 Every page of each **Site Responsibility Schedule** shall bear the date of issue and the issue number.

Accuracy Confirmation

CC.A.1.1.8 When a **Site Responsibility Schedule** is prepared it shall be sent by **NGET** to the **Users** involved for confirmation of its accuracy.

CC.A.1.1.9 The **Site Responsibility Schedule** shall then be signed on behalf of **NGET** by its **Responsible Manager** (see CC.A.1.1.16) and on behalf of each **User** involved by its **Responsible Manager** (see CC.A.1.1.16), by way of written confirmation of its accuracy. For **Connection Sites** in Scotland or **Offshore**, the **Site Responsibility Schedule** will also be signed on behalf of the **Relevant Transmission Licensee** by its **Responsible Manager**.

Distribution and Availability

CC.A.1.1.10 Once signed, two copies will be distributed by **NGET**, not less than two weeks prior to its implementation date, to each **User** which is a party on the **Site Responsibility Schedule**, accompanied by a note indicating the issue number and the date of implementation.

CC.A.1.1.11 **NGET** and **Users** must make the **Site Responsibility Schedules** readily available to operational staff at the **Complex** and at the other relevant control points.

Alterations to Existing Site Responsibility Schedules

CC.A.1.1.12 Without prejudice to the provisions of CC.A.1.1.15 which deals with urgent changes, when a **User** identified on a **Site Responsibility Schedule** becomes aware that an alteration is necessary, it must inform **NGET** immediately and in any event 8 weeks prior to any change taking effect (or as soon as possible after becoming aware of it, if less than 8 weeks remain when the **User** becomes aware of the change). This will cover the commissioning of new **Plant** and/or **Apparatus** at the **Connection Site**, whether requiring a revised **Bilateral Agreement** or not, de-commissioning of **Plant** and/or **Apparatus**, and other changes which affect the accuracy of the **Site Responsibility Schedule**.

CC.A.1.1.13 Where **NGET** has been informed of a change by an **GB Code User**, or itself proposes a change, it will prepare a revised **Site Responsibility Schedule** by not less than six weeks prior to the change taking effect (subject to it having been informed or knowing of the change eight weeks prior to that time) and the procedure set out in CC.A.1.1.8 shall be followed with regard to the revised **Site Responsibility Schedule**.

Formatted: Highlight

Formatted: Highlight

¹ Details of circuits traversing the **Connection Site** are only needed from the date which is the earlier of the date when the **Site Responsibility Schedule** is first updated and 15th October 2004. In Scotland or **Offshore**, from a date to be agreed between **NGET** and the **Relevant Transmission Licensee**.

CC.A 1.1.14 The revised **Site Responsibility Schedule** shall then be signed in accordance with the procedure set out in CC.A.1.1.9 and distributed in accordance with the procedure set out in CC.A.1.1.10, accompanied by a note indicating where the alteration(s) has/have been made, the new issue number and the date of implementation.

Urgent Changes

CC.A.1.1.15 When an **GB Code User** identified on a **Site Responsibility Schedule**, or **NGET**, as the case may be, becomes aware that an alteration to the **Site Responsibility Schedule** is necessary urgently to reflect, for example, an emergency situation which has arisen outside its control, the **GB Code User** shall notify **NGET**, or **NGET** shall notify the **GB Code User**, as the case may be, immediately and will discuss:

- (a) what change is necessary to the **Site Responsibility Schedule**;
- (b) whether the **Site Responsibility Schedule** is to be modified temporarily or permanently;
- (c) the distribution of the revised **Site Responsibility Schedule**.

NGET will prepare a revised **Site Responsibility Schedule** as soon as possible, and in any event within seven days of it being informed of or knowing the necessary alteration. The **Site Responsibility Schedule** will be confirmed by **GB Code Users** and signed on behalf of **NGET** and **GB Code Users** (by the persons referred to in CC.A.1.1.9) as soon as possible after it has been prepared and sent to **GB Code Users** for confirmation.

Responsible Managers

CC.A.1.1.16 Each **GB Code User** shall, prior to the **Completion Date** under each **Bilateral Agreement** and/or **Construction Agreement**, supply to **NGET** a list of Managers who have been duly authorised to sign **Site Responsibility Schedules** on behalf of the **GB Code User** and **NGET** shall, prior to the **Completion Date** under each **Bilateral Agreement** and/or **Construction Agreement**, supply to that **GB Code User** the name of its **Responsible Manager** and for **Connection Sites** in Scotland or **Offshore**, the name of the **Relevant Transmission Licensee's Responsible Manager** and each shall supply to the other any changes to such list six weeks before the change takes effect where the change is anticipated, and as soon as possible after the change, where the change was not anticipated.

De-commissioning of Connection Sites

CC.A.1.1.17 Where a **Connection Site** is to be de-commissioned, whichever of **NGET** or the **GB Code User** who is initiating the de-commissioning must contact the other to arrange for the **Site Responsibility Schedule** to be amended at the relevant time.

PROFORMA FOR SITE RESPONSIBILITY SCHEDULE

AREA _____

COMPLEX: _____ SCHEDULE: _____

CONNECTION SITE: _____

- Formatted: Highlight
- Formatted: Highlight
- Formatted: Highlight
- Formatted: Highlight
- Formatted: Highlight
- Formatted: Highlight
- Formatted: Highlight

ITEM OF PLANT/ APPARATUS	PLANT APPARATUS OWNER	SITE MANAGER	SAFETY		OPERATIONS		PARTY RESPONSIBLE FOR UNDERTAKING STATUTORY INSPECTIONS, FAULT INVESTIGATION & MAINTENANCE	REMARKS
			SAFETY RULES	CONTROL OR OTHER RESPONSIBLE PERSON (SAFETY CO-ORDINATOR)	OPERATIONAL PROCEDURES	CONTROL OR OTHER RESPONSIBLE ENGINEER		

Formatted: Highlight

PAGE: _____ ISSUE NO: _____ DATE: _____

Formatted: Highlight

Formatted: Highlight

PROFORMA FOR SITE RESPONSIBILITY SCHEDULE

_____ **AREA**

COMPLEX: _____

SCHEDULE: _____

CONNECTION SITE: _____

Formatted: Highlight

Formatted: Highlight

Formatted: Highlight

ITEM OF PLANT/ APPARATUS	PLANT APPARATUS OWNER	SITE MANAGER	SAFETY		OPERATIONS		PARTY RESPONSIBLE FOR UNDERTAKING STATUTORY INSPECTIONS, FAULT INVESTIGATION & MAINTENANCE	REMARKS
			SAFETY RULES	CONTROL OR OTHER RESPONSIBLE PERSON (SAFETY CO- ORDINATOR	OPERATIONAL PROCEDURES	CONTROL OR OTHER RESPONSIBLE ENGINEER		

Formatted: Highlight

NOTES:

Formatted: Highlight

SIGNED: _____ **NAME:** _____ **COMPANY:** _____ **DATE:** _____

SIGNED: _____ **NAME:** _____ **COMPANY:** _____ **DATE:** _____

SIGNED: _____ **NAME:** _____ **COMPANY:** _____ **DATE:** _____

SIGNED: _____ **NAME:** _____ **COMPANY:** _____ **DATE:** _____

PAGE: _____ **ISSUE NO:** _____ **DATE:** _____

Formatted: Highlight

Formatted: Highlight

Formatted: Highlight

Formatted: Highlight

Formatted: Highlight

**SP TRANSMISSION Ltd
SITE RESPONSIBILITY SCHEDULE
OWNERSHIP, MAINTENANCE AND OPERATIONS OF EQUIPMENT
IN JOINT USER SITUATIONS**

Sheet No. _____
Revision: _____
Date: _____

Network Area: _____

SECTION 'A' BUILDING AND SITE

OWNER	ACCESS REQUIRED:-
LESSEE	SPECIAL CONDITIONS:-
MAINTENANCE	LOCATION OF SUPPLY TERMINALS:-
SAFETY	
SECURITY	

SECTION 'B' CUSTOMER OR OTHER PARTY

NAME:-
ADDRESS:-
TELNO:-
SUB STATION
LOCATION:-

SECTION 'C' PLANT

ITEM Nos	EQUIPMENT	IDENTIFICATION	OWNER	SAFETY RULES APPLICABLE	OPERATION			MAINTENANCE			FAULT INVESTIGATION			TESTING		RELAY SETTINGS	REMARKS
					Tripping	Clearing	Loading	Earthing	Primary Equip.	Protection Equip.	Resonance Equip.	Trip and Alarm	Primary Equip.				

SECTION 'D' CONFIGURATION AND CONTROL

ITEM Nos	CONFIGURATION RESPONSIBILITY	TELEPHONE NUMBER	REMARKS

SECTION 'E' ADDITIONAL INFORMATION

--	--	--	--	--	--	--	--	--	--	--	--	--	--	--	--	--	--

ABBREVIATIONS:
 D - SP AUTHORIZED PERSON - DISTRIBUTION SYSTEM
 NGC - NATIONAL GRID COMPANY
 SPS - SCOTCH POWER SYSTEMS
 SPT - SP TRANSMISSION Ltd
 ST - SCOTCH POWER TELECOMMUNICATIONS
 T - SP AUTHORIZED PERSON - TRANSMISSION SYSTEM
 U - USER

SIGNED _____ FOR _____ SP Transmission DATE _____
 SIGNED _____ FOR _____ SP Distribution DATE _____
 SIGNED _____ FOR _____ PowerSystems/User DATE _____

Formatted: Highlight
 Formatted: Highlight

Scottish Hydro-Electric Transmission Limited
 Site Responsibility Schedule

Substation Type		Number:				Revision:			
Equipment	Owner	Controller	Maintainer	Responsible System User	Responsible Management Unit	Control Authority	Safety Rules	Operational Procedures	Notes

Formatted: Highlight

APPENDIX 2 - OPERATION DIAGRAMS

PART 1A - PROCEDURES RELATING TO OPERATION DIAGRAMS

FIXED CAPACITOR		SWITCH DISCONNECTOR	
EARTH		SWITCH DISCONNECTOR WITH INCORPORATED EARTH SWITCH	
EARTHING RESISTOR		DISCONNECTOR (CENTRE ROTATING POST)	
LIQUID EARTHING RESISTOR		DISCONNECTOR (SINGLE BREAK DOUBLE ROTATING)	
ARC SUPPRESSION COIL		DISCONNECTOR (SINGLE BREAK)	
FIXED MAINTENANCE EARTHING DEVICE		DISCONNECTOR (NON-INTERLOCKED)	
CARRIER COUPLING EQUIPMENT (WITHOUT VT)		DISCONNECTOR (POWER OPERATED)	
CARRIER COUPLING EQUIPMENT (WITH VT ON ONE PHASE)		DISCONNECTOR (NON-AUTOMATIC)	
CARRIER COUPLING EQUIPMENT (WITH VT ON 3 PHASES)		DISCONNECTOR (SEQUENTIAL OPERATION)	
AC GENERATOR		DISCONNECTOR (FAULT INTERFERING OPERATION)	
SYNCHRONOUS COMPENSATOR		EARTH SWITCH	
CIRCUIT BREAKER		FAULT THROWING SWITCH (PHASE TO PHASE)	
CIRCUIT BREAKER WITH DELAYED AUTO RECLOSE		FAULT THROWING SWITCH (EARTH FAULT)	
WITHDRAWABLE METALCLAD SWITCHGEAR		SURGE ARRESTOR	
		THRISTOR	

Formatted: Highlight

Formatted: Highlight

Formatted: Highlight

Formatted: Highlight

Formatted: Highlight

Formatted: Highlight

Formatted: Highlight

Formatted: Highlight

Formatted: Highlight

Formatted: Highlight

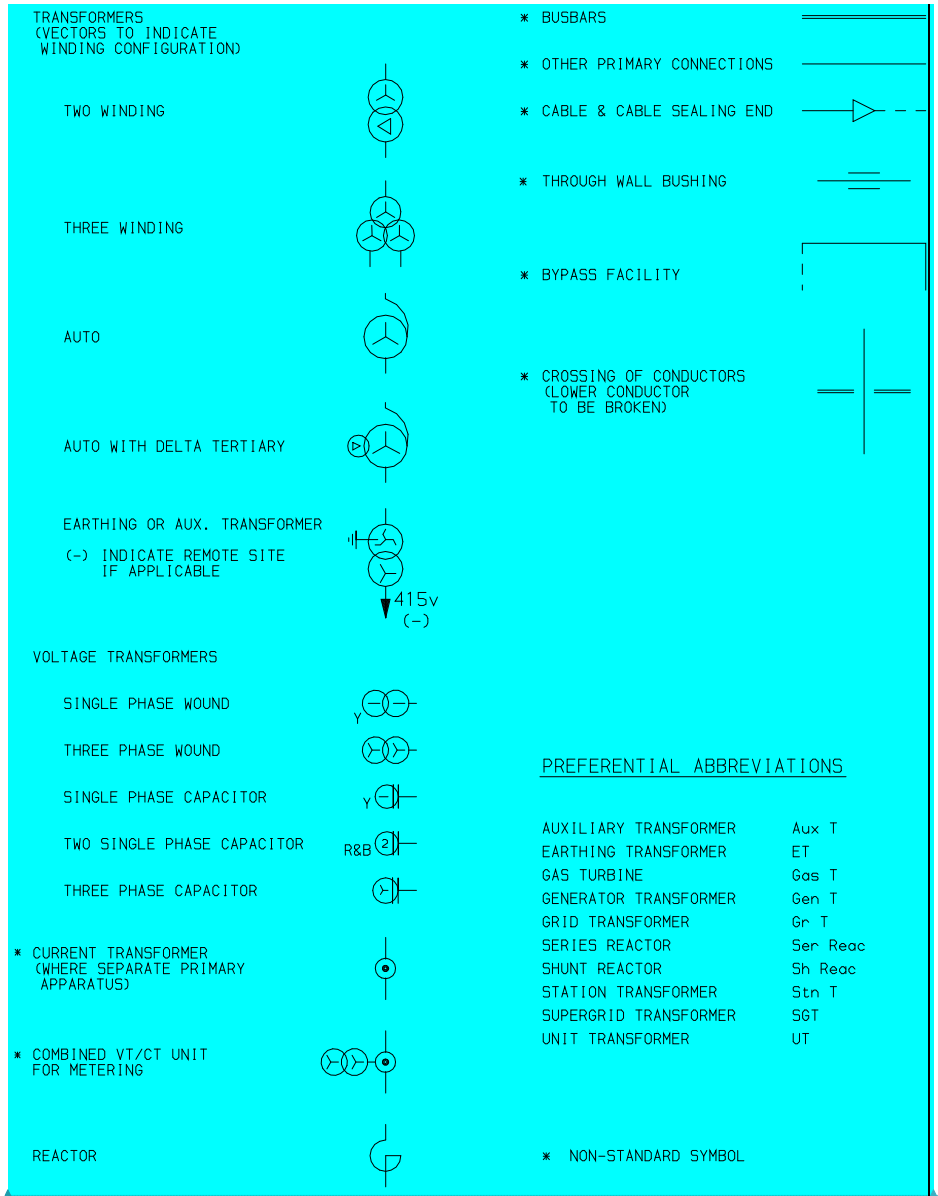

Formatted: Highlight

Formatted: Highlight

PORTABLE MAINTENANCE
EARTH DEVICE



DISCONNECTOR
(PANTOGRAPH TYPE)



QUADRATURE BOOSTER

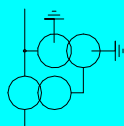

DISCONNECTOR
(KNEE TYPE)



SHORTING/DISCHARGE SWITCH

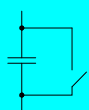

CAPACITOR
(INCLUDING HARMONIC FILTER)



SINGLE PHASE TRANSFORMER (BR)
NEUTRAL AND PHASE CONNECTIONS

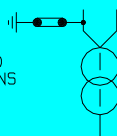

RESISTOR WITH INHERENT
NON-LINEAR VARIABILITY,
VOLTAGE DEPENDANT



Formatted: Highlight

Formatted: Highlight

PART 1B - PROCEDURES RELATING TO GAS ZONE DIAGRAMS

GAS INSULATED BUSBAR		DOUBLE-BREAK DISCONNECTOR	
GAS BOUNDARY		EXTERNAL MOUNTED CURRENT TRANSFORMER (WHERE SEPARATE PRIMARY APPARATUS)	
GAS/GAS BOUNDARY		STOP VALVE NORMALLY CLOSED	
GAS/CABLE BOUNDARY		STOP VALVE NORMALLY OPEN	
GAS/AIR BOUNDARY		GAS MONITOR	
GAS/TRANSFORMER BOUNDARY		FILTER	
MAINTENANCE VALVE		QUICK ACTING COUPLING	

- Formatted: Highlight
- Formatted: Highlight
- Formatted: Highlight
- Formatted: Highlight
- Formatted: Highlight
- Formatted: Highlight

PART 2 - NON-EXHAUSTIVE LIST OF APPARATUS TO BE INCLUDED ON OPERATION DIAGRAMS

Basic Principles

- (1) Where practicable, all the **HV Apparatus** on any **Connection Site** shall be shown on one **Operation Diagram**. Provided the clarity of the diagram is not impaired, the layout shall represent as closely as possible the geographical arrangement on the **Connection Site**.
- (2) Where more than one **Operation Diagram** is unavoidable, duplication of identical information on more than one **Operation Diagram** must be avoided.
- (3) The **Operation Diagram** must show accurately the current status of the **Apparatus** e.g. whether commissioned or decommissioned. Where decommissioned, the associated switchbay will be labelled "spare bay".
- (4) Provision will be made on the **Operation Diagram** for signifying approvals, together with provision for details of revisions and dates.
- (5) **Operation Diagrams** will be prepared in A4 format or such other format as may be agreed with **NGET**.
- (6) The **Operation Diagram** should normally be drawn single line. However, where appropriate, detail which applies to individual phases shall be shown. For example, some **HV Apparatus** is numbered individually per phase.

Apparatus To Be Shown On Operation Diagram

- (1) Busbars
- (2) Circuit Breakers
- (3) Disconnecter (Isolator) and Switch Disconnecters (Switching Isolators)
- (4) Disconnectors (Isolators) - Automatic Facilities
- (5) Bypass Facilities
- (6) Earthing Switches
- (7) Maintenance Earths
- (8) Overhead Line Entries
- (9) Overhead Line Traps
- (10) Cable and Cable Sealing Ends
- (11) Generating Unit
- (12) Generator Transformers
- (13) Generating Unit Transformers, Station Transformers, including the lower voltage circuit-breakers.
- (14) Synchronous Compensators
- (15) Static Variable Compensators
- (16) Capacitors (including Harmonic Filters)
- (17) Series or Shunt Reactors (Referred to as "Inductors" at nuclear power station sites)
- (18) Supergrid and Grid Transformers
- (19) Tertiary Windings
- (20) Earthing and Auxiliary Transformers
- (21) Three Phase VT's

Formatted: Highlight

Formatted: Highlight

Formatted: Highlight

Formatted: Highlight

- (22) Single Phase VT & Phase Identity
- (23) High Accuracy VT and Phase Identity
- (24) Surge Arrestors/Diverter
- (25) Neutral Earthing Arrangements on HV Plant
- (26) Fault Throwing Devices
- (27) Quadrature Boosters
- (28) Arc Suppression Coils
- (29) Single Phase Transformers (BR) Neutral and Phase Connections
- (30) Current Transformers (where separate plant items)
- (31) Wall Bushings
- (32) Combined VT/CT Units
- (33) Shorting and Discharge Switches
- (34) Thyristor
- (35) Resistor with Inherent Non-Linear Variability, Voltage Dependent
- (36) Gas Zone

APPENDIX 3 - MINIMUM FREQUENCY RESPONSE REQUIREMENT PROFILE AND OPERATING RANGE FOR NEW POWER STATIONS AND DC CONVERTER STATIONS

CC.A.3.1 Scope

The frequency response capability is defined in terms of **Primary Response**, **Secondary Response** and **High Frequency Response**. This appendix defines the minimum frequency response requirement profile for:

- (a) each **Onshore Generating Unit** and/or **CCGT Module** which has a **Completion Date** after 1 January 2001 in England and Wales and 1 April 2005 in Scotland and **Offshore Generating Unit** in a **Large Power Station**.
- (b) each **DC Converter** at a **DC Converter Station** which has a **Completion Date** on or after 1 April 2005 or each **Offshore DC Converter** which is part of a **Large Power Station**.
- (c) each **Onshore Power Park Module** in England and Wales with a **Completion Date** on or after 1 January 2006.
- (d) each **Onshore Power Park Module** in operation in Scotland after 1 January 2006 with a **Completion Date** after 1 April 2005 and in **Power Stations** with a **Registered Capacity** of 50MW or more.
- (e) each **Offshore Power Park Module** in a **Large Power Station** with a **Registered Capacity** of 50MW or more.

For the avoidance of doubt, this appendix does not apply to:

- (i) **Generating Units** and/or **CCGT Modules** which have a **Completion Date** before 1 January 2001 in England and Wales and before 1 April 2005 in Scotland,
- (ii) **DC Converters** at a **DC Converter Station** which have a **Completion Date** before 1 April 2005.
- (iii) **Power Park Modules** in England and Wales with a **Completion Date** before 1 January 2006.
- (iv) **Power Park Modules** in operation in Scotland before 1 January 2006.
- (v) **Power Park Modules** in Scotland with a **Completion Date** before 1 April 2005.
- (vi) **Power Park Modules** in **Power Stations** with a **Registered Capacity** less than 50MW.
- (vii) **Small Power Stations** or individually to **Power Park Units**; or
- (viii) an **OTSDUW DC Converter** where the **Interface Point Capacity** is less than 50MW.

OTSDUW Plant and Apparatus should facilitate the delivery of frequency response services provided by **Offshore Generating Units** and **Offshore Power Park Modules** at the **Interface Point**.

The functional definition provides appropriate performance criteria relating to the provision of Frequency control by means of Frequency sensitive generation in addition to the other requirements identified in CC.6.3.7.

In this Appendix 3 to the CC, for a **CCGT Module** or a **Power Park Module** with more than one **Generating Unit**, the phrase **Minimum Generation** applies to the entire **CCGT Module** or **Power Park Module** operating with all **Generating Units Synchronised** to the **System**.

The minimum **Frequency** response requirement profile is shown diagrammatically in Figure CC.A.3.1. The capability profile specifies the minimum required levels of **Primary Response**, **Secondary Response** and **High Frequency Response** throughout the normal plant operating range. The definitions of these **Frequency** response capabilities are illustrated diagrammatically in Figures CC.A.3.2 & CC.A.3.3.

Formatted: Highlight

Formatted: Highlight

Formatted: Highlight

Formatted: Highlight

CC.A.3.2 Plant Operating Range

The upper limit of the operating range is the **Registered Capacity** of the **Generating Unit** or **CCGT Module** or **DC Converter** or **Power Park Module**.

The **Minimum Generation** level may be less than, but must not be more than, 65% of the **Registered Capacity**. Each **Generating Unit** and/or **CCGT Module** and/or **Power Park Module** and/or **DC Converter** must be capable of operating satisfactorily down to the **Designed Minimum Operating Level** as dictated by **System** operating conditions, although it will not be instructed to below its **Minimum Generation** level. If a **Generating Unit** or **CCGT Module** or **Power Park Module** or **DC Converter** is operating below **Minimum Generation** because of high **System Frequency**, it should recover adequately to its **Minimum Generation** level as the **System Frequency** returns to **Target Frequency** so that it can provide **Primary** and **Secondary Response** from **Minimum Generation** if the **System Frequency** continues to fall. For the avoidance of doubt, under normal operating conditions steady state operation below **Minimum Generation** is not expected. The **Designed Minimum Operating Level** must not be more than 55% of **Registered Capacity**.

In the event of a **Generating Unit** or **CCGT Module** or **Power Park Module** or **DC Converter** load rejecting down to no less than its **Designed Minimum Operating Level** it should not trip as a result of automatic action as detailed in BC3.7. If the load rejection is to a level less than the **Designed Minimum Operating Level** then it is accepted that the condition might be so severe as to cause it to be disconnected from the **System**.

CC.A.3.3 Minimum Frequency Response Requirement Profile

Figure CC.A.3.1 shows the minimum **Frequency** response requirement profile diagrammatically for a 0.5 Hz change in **Frequency**. The percentage response capabilities and loading levels are defined on the basis of the **Registered Capacity** of the **Generating Unit** or **CCGT Module** or **Power Park Module** or **DC Converter**. Each **Generating Unit** and/or **CCGT Module** and/or **Power Park Module** and/or **DC Converter** must be capable of operating in a manner to provide **Frequency** response at least to the solid boundaries shown in the figure. If the **Frequency** response capability falls within the solid boundaries, the **Generating Unit** or **CCGT Module** or **Power Park Module** or **DC Converter** is providing response below the minimum requirement which is not acceptable. Nothing in this appendix is intended to prevent a **Generating Unit** or **CCGT Module** or **Power Park Module** or **DC Converter** from being designed to deliver a **Frequency** response in excess of the identified minimum requirement.

The **Frequency** response delivered for **Frequency** deviations of less than 0.5 Hz should be no less than a figure which is directly proportional to the minimum **Frequency** response requirement for a **Frequency** deviation of 0.5 Hz. For example, if the **Frequency** deviation is 0.2 Hz, the corresponding minimum **Frequency** response requirement is 40% of the level shown in Figure CC.A.3.1. The **Frequency** response delivered for **Frequency** deviations of more than 0.5 Hz should be no less than the response delivered for a **Frequency** deviation of 0.5 Hz.

Each **Generating Unit** and/or **CCGT Module** and/or **Power Park Module** and/or **DC Converter** must be capable of providing some response, in keeping with its specific operational characteristics, when operating between 95% to 100% of **Registered Capacity** as illustrated by the dotted lines in Figure CC.A.3.1.

At the **Minimum Generation** level, each **Generating Unit** and/or **CCGT Module** and/or **Power Park Module** and/or **DC Converter** is required to provide high and low frequency response depending on the **System Frequency** conditions. Where the **Frequency** is high, the **Active Power** output is therefore expected to fall below the **Minimum Generation** level.

The **Designed Minimum Operating Level** is the output at which a **Generating Unit** and/or **CCGT Module** and/or **Power Park Module** and/or **DC Converter** has no **High Frequency Response** capability. It may be less than, but must not be more than, 55% of the **Registered Capacity**. This implies that a **Generating Unit** or **CCGT Module** or **Power Park Module** or **DC Converter** is not obliged to reduce its output to below this level unless the **Frequency** is at or above 50.5 Hz (cf BC3.7).

CC.A.3.4 Testing Of Frequency Response Capability

The response capabilities shown diagrammatically in Figure CC.A.3.1 are measured by taking the responses as obtained from some of the dynamic response tests specified by NGET and carried out by GB Generators and DC Converter Station owners for compliance purposes and to validate the content of Ancillary Services Agreements using an injection of a Frequency change to the plant control system (i.e. governor and load controller). The injected signal is a linear ramp from zero to 0.5 Hz Frequency change over a ten second period, and is sustained at 0.5 Hz Frequency change thereafter, as illustrated diagrammatically in figures CC.A.3.2 and CC.A.3.3. In the case of an Embedded Medium Power Station not subject to a Bilateral Agreement or Embedded DC Converter Station not subject to a Bilateral Agreement, NGET may require the Network Operator within whose System the Embedded Medium Power Station or Embedded DC Converter Station is situated, to ensure that the Embedded Person performs the dynamic response tests reasonably required by NGET in order to demonstrate compliance within the relevant requirements in the CC.

The Primary Response capability (P) of a Generating Unit or a CCGT Module or Power Park Module or DC Converter is the minimum increase in Active Power output between 10 and 30 seconds after the start of the ramp injection as illustrated diagrammatically in Figure CC.A.3.2. This increase in Active Power output should be released increasingly with time over the period 0 to 10 seconds from the time of the start of the Frequency fall as illustrated by the response from Figure CC.A.3.2.

The Secondary Response capability (S) of a Generating Unit or a CCGT Module or Power Park Module or DC Converter is the minimum increase in Active Power output between 30 seconds and 30 minutes after the start of the ramp injection as illustrated diagrammatically in Figure CC.A.3.2.

The High Frequency Response capability (H) of a Generating Unit or a CCGT Module or Power Park Module or DC Converter is the decrease in Active Power output provided 10 seconds after the start of the ramp injection and sustained thereafter as illustrated diagrammatically in Figure CC.A.3.3. This reduction in Active Power output should be released increasingly with time over the period 0 to 10 seconds from the time of the start of the Frequency rise as illustrated by the response in Figure CC.A.3.2.

CC.A.3.5 Repeatability Of Response

When a Generating Unit or CCGT Module or Power Park Module or DC Converter has responded to a significant Frequency disturbance, its response capability must be fully restored as soon as technically possible. Full response capability should be restored no later than 20 minutes after the initial change of System Frequency arising from the Frequency disturbance.

Figure CC.A.3.1 - Minimum Frequency Response Requirement Profile for a 0.5 Hz frequency change from Target Frequency

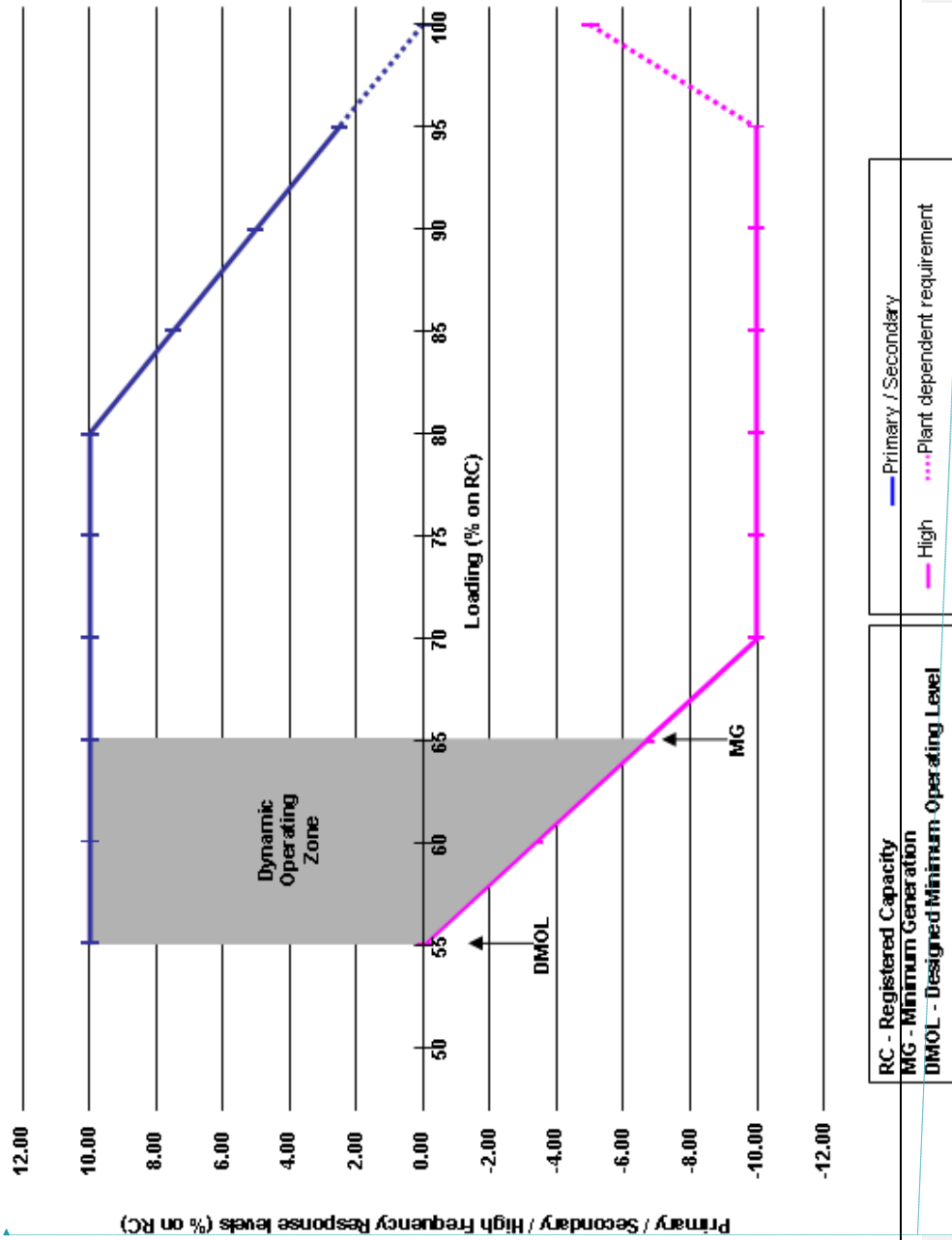

Formatted: Highlight

Formatted: Highlight

Figure CC.A.3.2 - Interpretation of Primary and Secondary Response Values

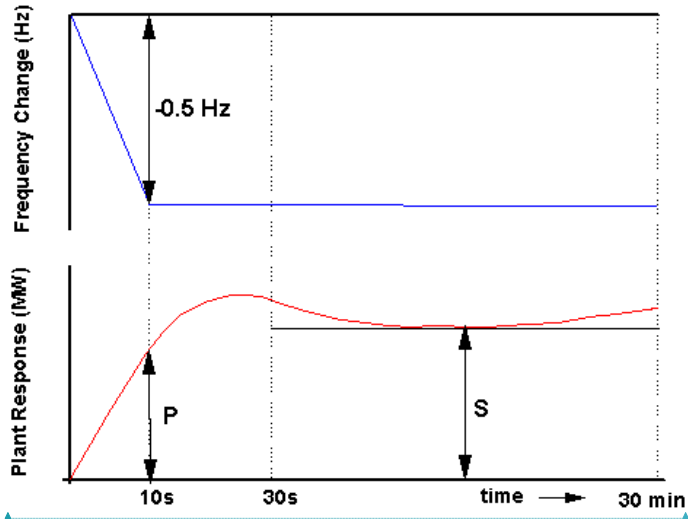

Formatted: Highlight

Formatted: Highlight

Figure CC.A.3.3 - Interpretation of High Frequency Response Values

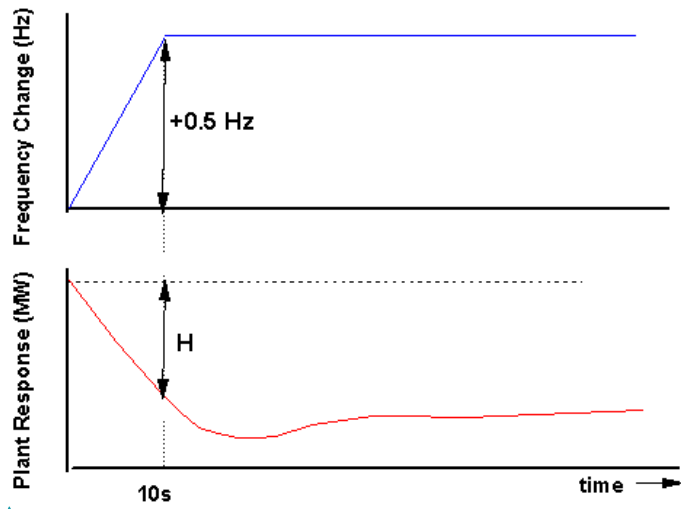

Formatted: Highlight

Formatted: Highlight

APPENDIX 4 - FAULT RIDE THROUGH REQUIREMENTS

APPENDIX 4A - FAULT RIDE THROUGH REQUIREMENTS FOR ONSHORE SYNCHRONOUS GENERATING UNITS, ONSHORE POWER PARK MODULES, ONSHORE DC CONVERTERS OTSDUW PLANT AND APPARATUS AT THE INTERFACE POINT, OFFSHORE SYNCHRONOUS GENERATING UNITS IN A LARGE POWER STATION, OFFSHORE POWER PARK MODULES IN A LARGE POWER STATION AND OFFSHORE DC CONVERTERS IN A LARGE POWER STATION WHICH SELECT TO MEET THE FAULT RIDE THROUGH REQUIREMENTS AT THE INTERFACE POINT

CC.A.4A.1 Scope

The fault ride through requirement is defined in CC.6.3.15.1 (a), (b) and CC.6.3.15.3. This Appendix provides illustrations by way of examples only of CC.6.3.15.1 (a) (i) and further background and illustrations to CC.6.3.15.1 (1b) (i) and CC.6.3.15.1 (2b) (i) and is not intended to show all possible permutations.

CC.A.4A.2 Short Circuit Faults At Supergrid Voltage On The Onshore Transmission System Up To 140ms In Duration

For short circuit faults at **Supergrid Voltage** on the **Onshore Transmission System** (which could be at an **Interface Point**) up to 140ms in duration, the fault ride through requirement is defined in CC.6.3.15.1 (a) (i). Figures CC.A.4A.1 (a) and (b) illustrate two typical examples of voltage recovery for short-circuit faults cleared within 140ms by two circuit breakers (a) and three circuit breakers (b) respectively.

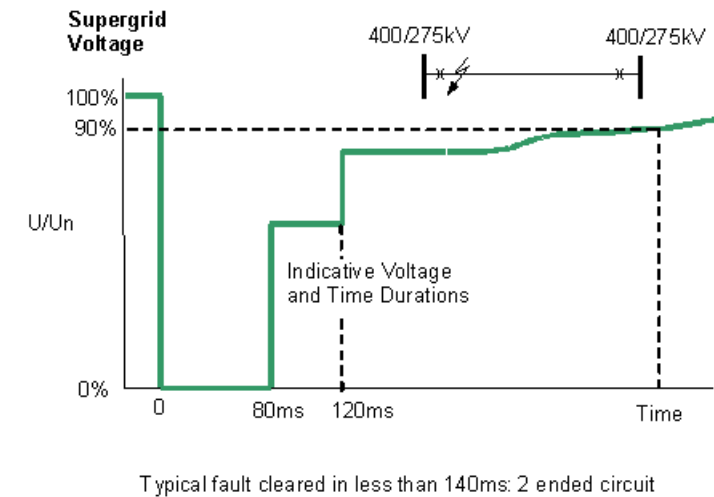

Figure CC.A.4A.1 (a)

Formatted: Highlight

Formatted: Highlight

Formatted: Highlight

Formatted: Highlight

Formatted: Highlight

Formatted: Highlight

Formatted: Highlight

Formatted: Highlight

Formatted: Highlight

Formatted: Highlight

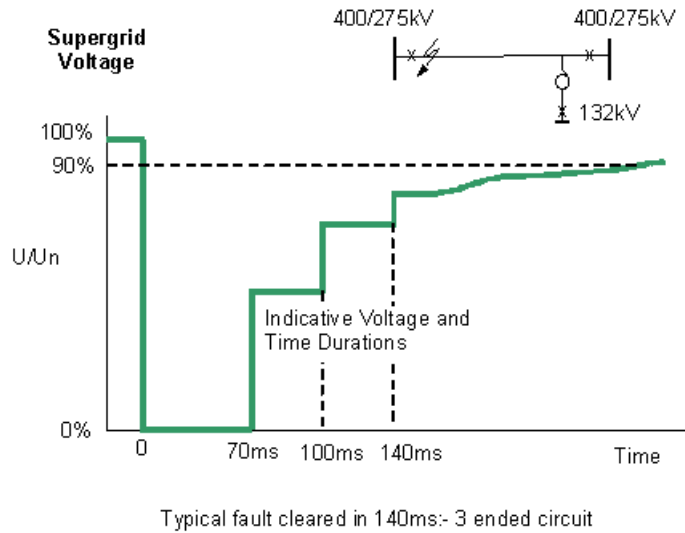

Figure CC.A.4A.1 (b)

CC.A.4A.3 Supergrid Voltage Dips On The Onshore Transmission System Greater Than 140ms In Duration

CC.A.4A3.1 Requirements applicable to **Synchronous Generating Units** subject to **Supergrid Voltage** dips on the **Onshore Transmission System** greater than 140ms in duration.

For balanced **Supergrid Voltage** dips on the **Onshore Transmission System** having durations greater than 140ms and up to 3 minutes, the fault ride through requirement is defined in CC.6.3.15.1 (1b) and Figure 5a which is reproduced in this Appendix as Figure CC.A.4A3.1 and termed the voltage-duration profile.

This profile is not a voltage-time response curve that would be obtained by plotting the transient voltage response at a point on the **Onshore Transmission System** (or **User System** if located **Onshore**) to a disturbance. Rather, each point on the profile (i.e. the heavy black line) represents a voltage level and an associated time duration which connected **Synchronous Generating Units** must withstand or ride through.

Figures CC.A.4A3.2 (a), (b) and (c) illustrate the meaning of the voltage-duration profile for voltage dips having durations greater than 140ms.

Formatted: Highlight
Formatted: Highlight

NOT TO SCALE

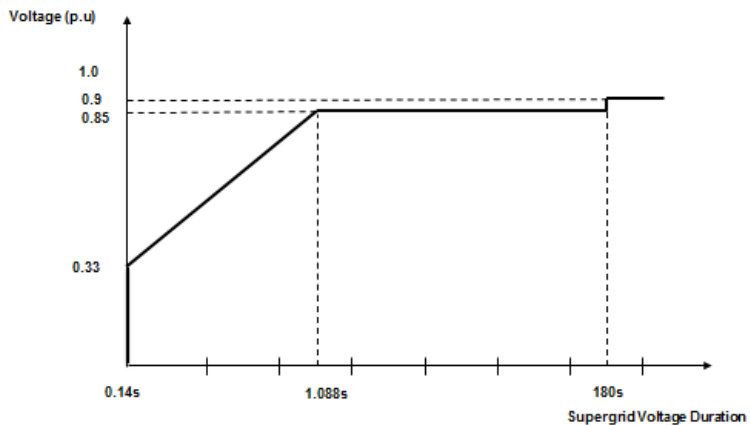

Figure CC.A.4A3.1

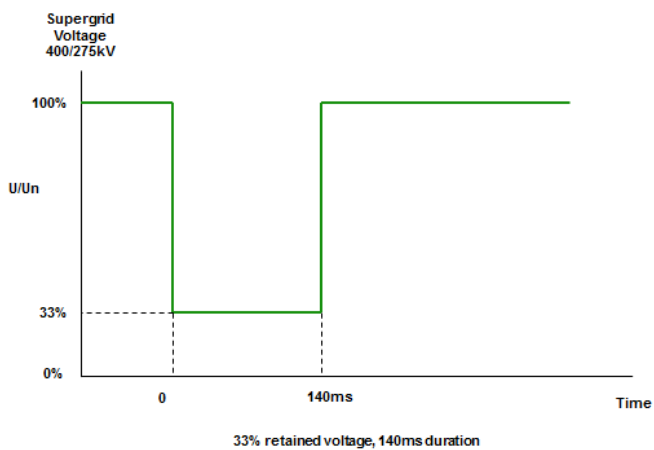

Figure CC.A.4A3.2 (a)

Formatted: Highlight

Formatted: Highlight

Formatted: Highlight

Formatted: Highlight

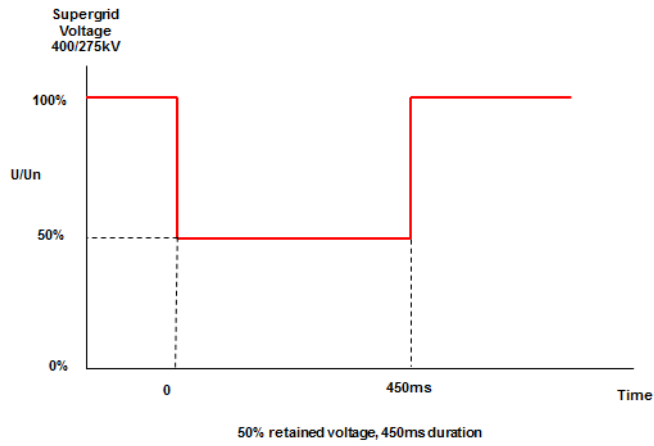

Figure CC.A.4A3.2 (b)

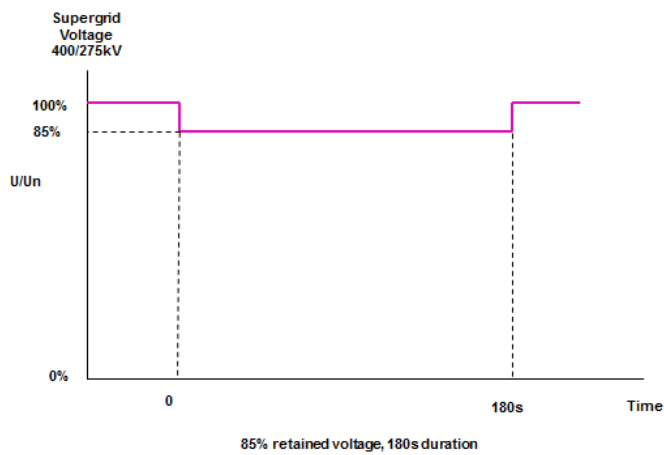

Figure CC.A.4A3.2 (c)

CC.A.4A3.2 Requirements applicable to **Power Park Modules** or **OTSDUW Plant and Apparatus** subject to **Supergrid Voltage** dips on the **Onshore Transmission System** greater than 140ms in duration

For balanced **Supergrid Voltage** dips on the **Onshore Transmission System** (which could be at an **Interface Point**) having durations greater than 140ms and up to 3 minutes the fault ride through requirement is defined in CC.6.3.15.1 (2b) and Figure 5b which is reproduced in this Appendix as Figure CC.A.4A3.3 and termed the voltage-duration profile.

Formatted: Highlight

Formatted: Highlight

Formatted: Highlight

Formatted: Highlight

This profile is not a voltage-time response curve that would be obtained by plotting the transient voltage response at a point on the **Onshore Transmission System** (or **User System** if located **Onshore**) to a disturbance. Rather, each point on the profile (i.e. the heavy black line) represents a voltage level and an associated time duration which connected **Power Park Modules** or **OTSDUW Plant and Apparatus** must withstand or ride through.

Figures CC.A.4A.4 (a), (b) and (c) illustrate the meaning of the voltage-duration profile for voltage dips having durations greater than 140ms.

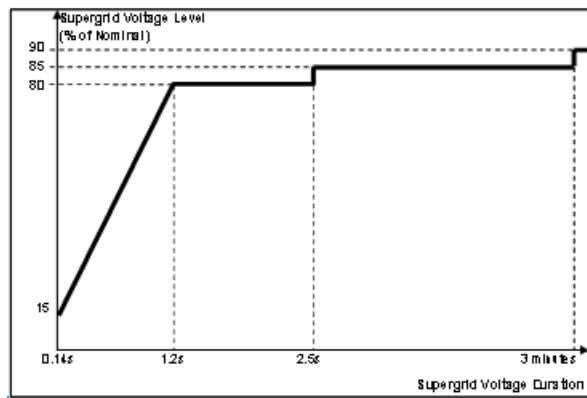

Figure CC.A.4A3.3

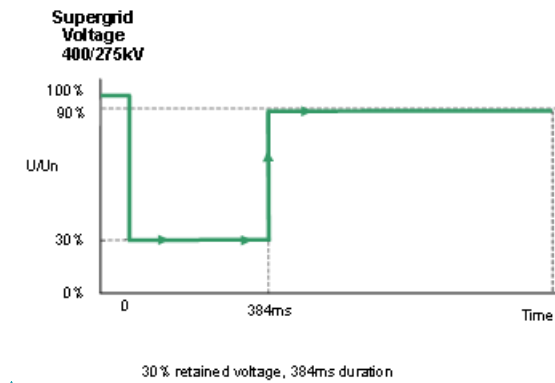

Figure CC.A.4A3.4 (a)

Formatted: Highlight

Formatted: Highlight

Formatted: Highlight

Formatted: Highlight

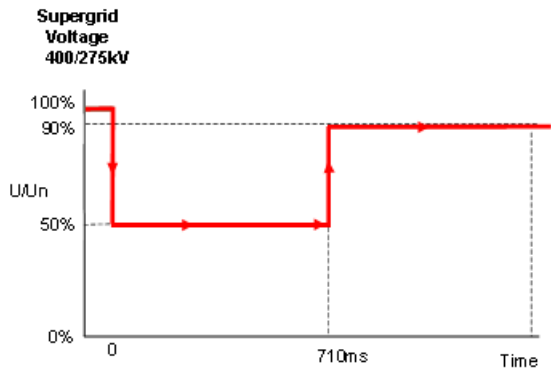

50% retained voltage, 710ms duration

Figure CC.A.4A3.4 (b)

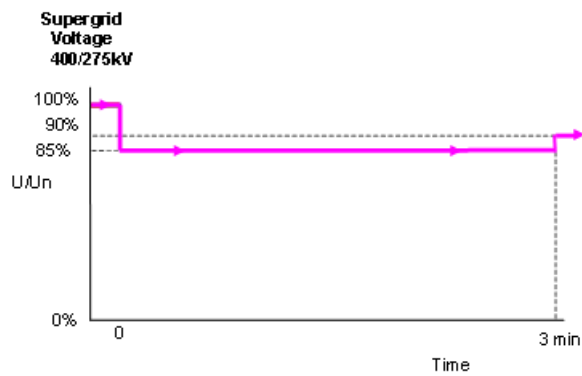

85% retained voltage, 3 minutes duration

Figure CC.A.4A3.4 (c)

Formatted: Highlight

Formatted: Highlight

Formatted: Highlight

Formatted: Highlight

APPENDIX 4B - FAULT RIDE THROUGH REQUIREMENTS FOR OFFSHORE GENERATING UNITS IN A LARGE POWER STATION, OFFSHORE POWER PARK MODULES IN A LARGE POWER STATION AND OFFSHORE DC CONVERTERS IN A LARGE POWER STATION WHICH SELECT TO MEET THE FAULT RIDE THROUGH REQUIREMENTS AT THE LV SIDE OF THE OFFSHORE PLATFORM AS SPECIFIED IN CC.6.3.15.2

CC.A.4B.1 Scope

The fault ride through requirement is defined in CC.6.3.15.2 (a), (b) and CC.6.3.15.3. This Appendix provides illustrations by way of examples only of CC.6.3.15.2 (a) (i) and further background and illustrations to CC.6.3.15.2 (1b) and CC.6.3.15.2 (2b) and is not intended to show all possible permutations.

CC.A.4B.2 Voltage Dips On The LV Side Of The Offshore Platform Up To 140ms In Duration

For voltage dips on the **LV Side of the Offshore Platform** which last up to 140ms in duration, the fault ride through requirement is defined in CC.6.3.15.2 (a) (i). This includes Figure 6 which is reproduced here in Figure CC.A.4B.1. The purpose of this requirement is to translate the conditions caused by a balanced or unbalanced fault which occurs on the **Onshore Transmission System** (which may include the **Interface Point**) at the **LV Side of the Offshore Platform**.

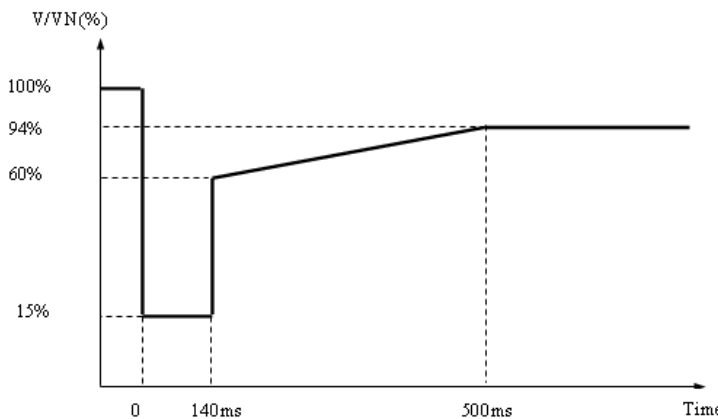

V/V_N is the ratio of the voltage at the **LV side of the Offshore Platform** to the nominal voltage of the LV side of the **Offshore Platform**.

Figure CC.A.4B.1

Figures CC.A.4B.2 (a) and CC.A.4B.2 (b) illustrate two typical examples of the voltage recovery seen at the **LV Side of the Offshore Platform** for a short circuit fault cleared within 140ms by (a) two circuit breakers and (b) three circuit breakers on the **Onshore Transmission System**.

Formatted: Highlight
Formatted: Highlight
Formatted: Highlight
Formatted: Highlight

Formatted: Highlight
Formatted: Highlight

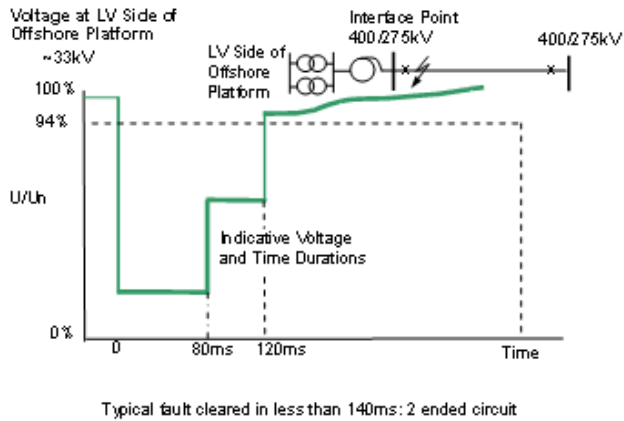

Figure CC.A.4B.2 (a)

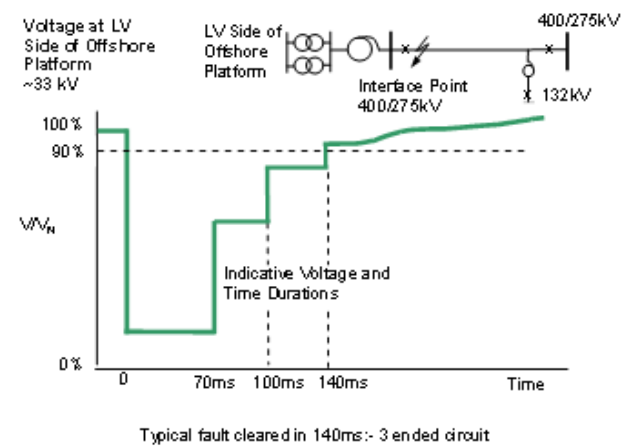

Figure CC.A.4B.2 (b)

CCA.4B.3 Voltage Dips Which Occur On The LV Side Of The Offshore Platform Greater Than 140ms In Duration

CCA.4B.3.1 Requirements applicable to **Offshore Synchronous Generating Units** subject to voltage dips which occur on the **LV Side of the Offshore Platform** greater than 140ms in duration.

In addition to CC.A.4B.2 the fault ride through requirements applicable to **Offshore Synchronous Generating Units** during balanced voltage dips which occur at the **LV Side of the Offshore Platform** and having durations greater than 140ms and up to 3 minutes are defined in CC.6.3.15.2 (1b) and Figure 7a which is reproduced in this Appendix as Figure CC.A.4B3.1 and termed the voltage-duration profile.

This profile is not a voltage-time response curve that would be obtained by plotting the transient voltage response at the **LV Side of the Offshore Platform** to a disturbance. Rather, each point on the profile (i.e. the heavy black line) represents a voltage level and an associated time duration which connected **Offshore Synchronous Generating Units** must withstand or ride through.

Formatted: Highlight
Formatted: Highlight

Formatted: Highlight
Formatted: Highlight

Figures CC.A.4B3.2 (a), (b) and (c) illustrate the meaning of the voltage-duration profile for voltage dips having durations greater than 140ms.

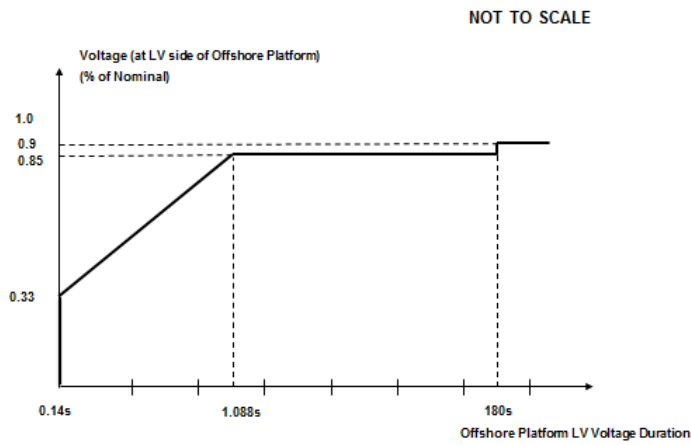

Figure CC.A.4B3.1

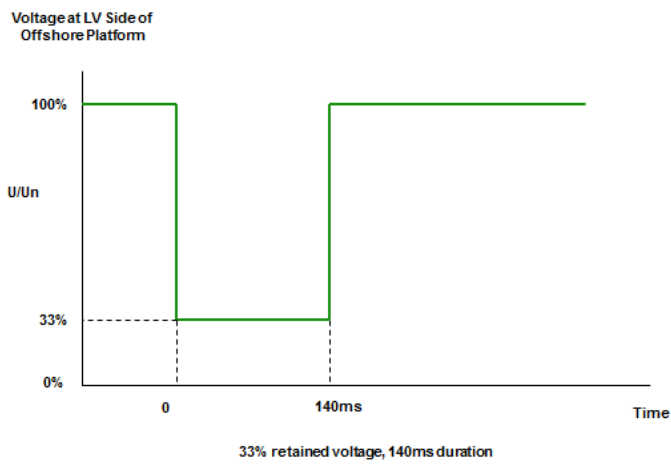

Figure CC.A.4B3.2 (a)

Formatted: Highlight

Formatted: Highlight

Formatted: Highlight

Formatted: Highlight

Voltage at LV Side of Offshore Platform

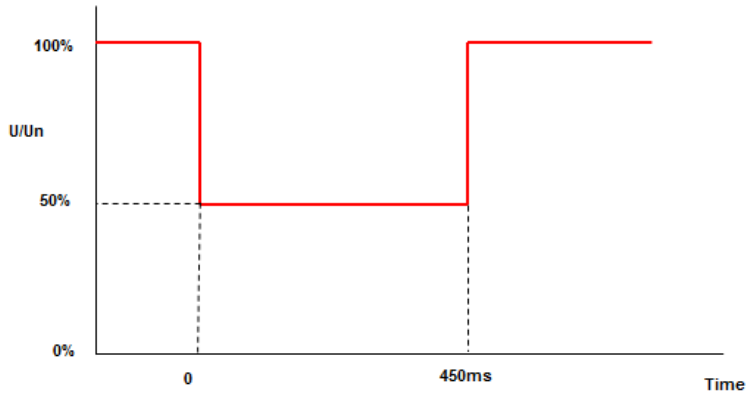

50% retained voltage, 450ms duration

Figure CC.A.4B3.2 (b)

Formatted: Highlight

Formatted: Highlight

Voltage at LV Side of Offshore Platform

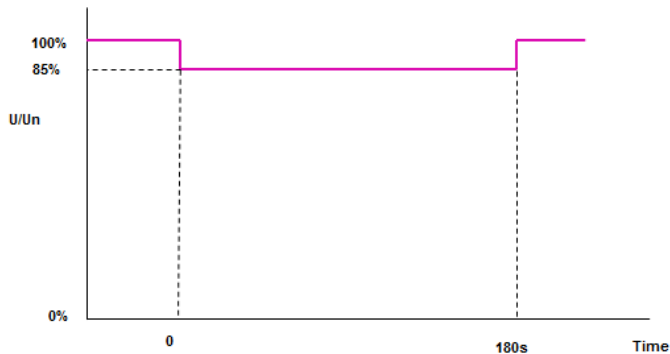

85% retained voltage, 180s duration

Figure CC.A.4B3.2 (c)

Formatted: Highlight

Formatted: Highlight

CC.A.4B.3.2 Requirements applicable to Offshore Power Park Modules subject to Voltage Dips Which Occur On The LV Side Of The Offshore Platform Greater Than 140ms in Duration.

In addition to CCA.4B.2 the fault ride through requirements applicable for Offshore Power Park Modules during balanced voltage dips which occur at the LV Side of the Offshore Platform and have durations greater than 140ms and up to 3 minutes are defined in CC.6.3.15.2 (2b) (i) and Figure 7b which is reproduced in this Appendix as Figure CC.A.4B.4 and termed the voltage-duration profile.

This profile is not a voltage-time response curve that would be obtained by plotting the transient voltage response at the **LV Side of the Offshore Platform** to a disturbance. Rather, each point on the profile (i.e. the heavy black line) represents a voltage level and an associated time duration which connected **Offshore Power Park Modules** must withstand or ride through.

Figures CC.A.4B.5 (a), (b) and (c) illustrate the meaning of the voltage-duration profile for voltage dips having durations greater than 140ms.

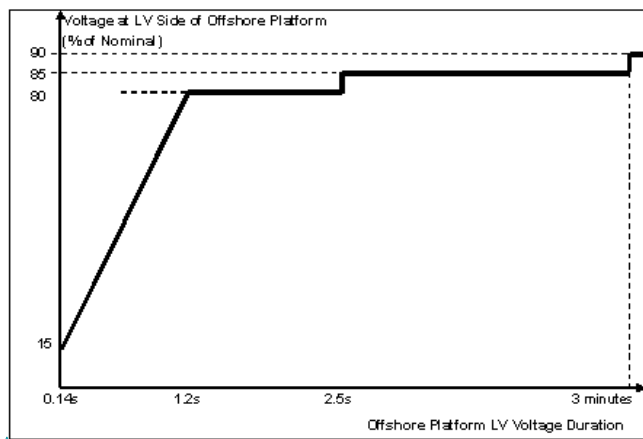

Figure CC.A.4B.4

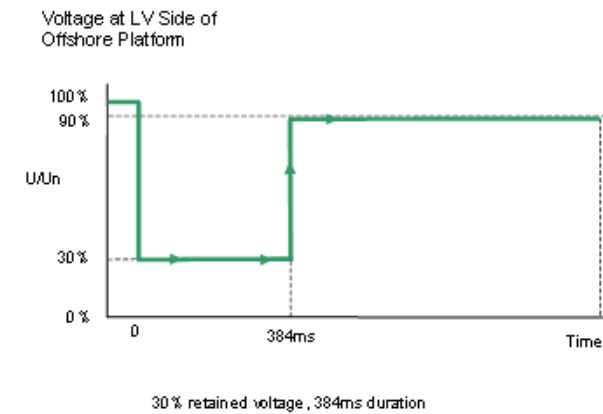

Figure CC.A.4B.5 (a)

Formatted: Highlight

Formatted: Highlight

Formatted: Highlight

Formatted: Highlight

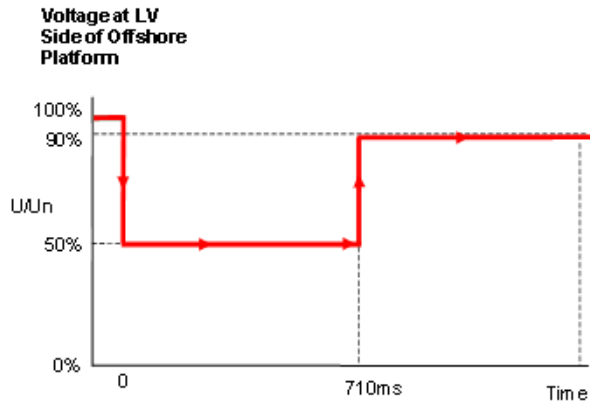

50% retained voltage, 710ms duration

Figure CC.A.4B.5(b)

Formatted: Highlight

Formatted: Highlight

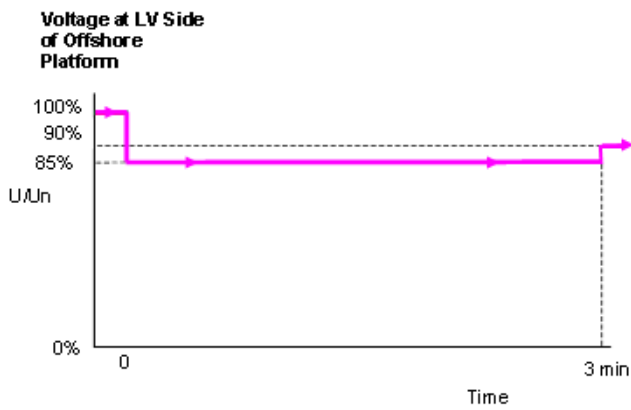

85% retained voltage, 3 minutes duration

Figure CC.A.4B.5(c)

Formatted: Highlight

Formatted: Highlight

APPENDIX 5 - TECHNICAL REQUIREMENTS

LOW FREQUENCY RELAYS FOR THE AUTOMATIC DISCONNECTION OF SUPPLIES AT LOW FREQUENCY

CC.A.5.1 Low Frequency Relays

CC.A.5.1.1 The **Low Frequency Relays** to be used shall have a setting range of 47.0 to 50Hz and be suitable for operation from a nominal AC input of 63.5, 110 or 240V. The following general parameters specify the requirements of approved **Low Frequency Relays** for automatic installations installed and commissioned after 1st April 2007 and provide an indication, without prejudice to the provisions that may be included in a **Bilateral Agreement**, for those installed and commissioned before 1st April 2007:

- (a) **Frequency** settings: 47-50Hz in steps of 0.05Hz or better, preferably 0.01Hz;
- (b) Operating time: Relay operating time shall not be more than 150 ms;
- (c) Voltage lock-out: Selectable within a range of 55 to 90% of nominal voltage;
- (d) Facility stages: One or two stages of **Frequency** operation;
- (e) Output contacts: Two output contacts per stage to be capable of repetitively making and breaking for 1000 operations;
- (f) Accuracy: 0.01 Hz maximum error under reference environmental and system voltage conditions.
0.05 Hz maximum error at 8% of total harmonic distortion
Electromagnetic Compatibility Level.

CC.A.5.2 Low Frequency Relay Voltage Supplies

CC.A.5.2.1 It is essential that the voltage supply to the **Low Frequency Relays** shall be derived from the primary **System** at the supply point concerned so that the **Frequency** of the **Low Frequency Relays** input voltage is the same as that of the primary **System**. This requires either:

- (a) the use of a secure supply obtained from voltage transformers directly associated with the grid transformer(s) concerned, the supply being obtained where necessary via a suitable automatic voltage selection scheme; or
- (b) the use of the substation 240V phase-to-neutral selected auxiliary supply, provided that this supply is always derived at the supply point concerned and is never derived from a standby supply **Generating Unit** or from another part of the **User System**.

CC.A.5.3 Scheme Requirements

CC.A.5.3.1 The tripping facility should be engineered in accordance with the following reliability considerations:

(a) Dependability

Failure to trip at any one particular **Demand** shedding point would not harm the overall operation of the scheme. However, many failures would have the effect of reducing the amount of **Demand** under low **Frequency** control. An overall reasonable minimum requirement for the dependability of the **Demand** shedding scheme is 96%, i.e. the average probability of failure of each **Demand** shedding point should be less than 4%. Thus the **Demand** under low **Frequency** control will not be reduced by more than 4% due to relay failure.

(b) Outages

Low **Frequency Demand** shedding schemes will be engineered such that the amount of **Demand** under control is as specified in Table CC.A.5.5.1a and is not reduced unacceptably during equipment outage or maintenance conditions.

CC.A.5.3.2 The total operating time of the scheme, including circuit breakers operating time, shall where reasonably practicable, be less than 200 ms. For the avoidance of doubt, the replacement of plant installed prior to October 2009 will not be required in order to achieve lower total scheme operating times.

CC.A.5.4 Low Frequency Relay Testing

CC.A.5.4.1 **Low Frequency Relays** installed and commissioned after 1st January 2007 shall be type tested in accordance with and comply with the functional test requirements for **Frequency Protection** contained in Energy Networks Association Technical Specification 48-6-5 Issue 1 dated 2005 "ENA **Protection** Assessment Functional Test Requirements – Voltage and Frequency **Protection**".

For the avoidance of doubt, **Low Frequency Relays** installed and commissioned before 1st January 2007 shall comply with the version of CC.A.5.1.1 applicable at the time such **Low Frequency Relays** were commissioned.

CC.A.5.5 Scheme Settings

CC.A.5.5.1 Table CC.A.5.5.1a shows, for each **Transmission Area**, the percentage of **Demand** (based on **Annual ACS Conditions**) at the time of forecast **National Electricity Transmission System** peak **Demand** that each **Network Operator** whose **System** is connected to the **Onshore Transmission System** within such **Transmission Area** shall disconnect by **Low Frequency Relays** at a range of frequencies. Where a **Network Operator's System** is connected to the **National Electricity Transmission System** in more than one **Transmission Area**, the settings for the **Transmission Area** in which the majority of the **Demand** is connected shall apply.

Frequency Hz	% Demand disconnection for each Network Operator in Transmission Area		
	NGET	SPT	SHETL
48.8	5		
48.75	5		
48.7	10		
48.6	7.5		10
48.5	7.5	10	
48.4	7.5	10	10
48.2	7.5	10	10
48.0	5	10	10
47.8	5		
Total % Demand	60	40	40

Table CC.A.5.5.1a

Note – the percentages in table CC.A.5.5.1a are cumulative such that, for example, should the frequency fall to 48.6 Hz in the **NGET Transmission Area**, 27.5% of the total **Demand** connected to the **National Electricity Transmission System** in the **NGET Transmission Area** shall be disconnected by the action of **Low Frequency Relays**.

The percentage **Demand** at each stage shall be allocated as far as reasonably practicable. The cumulative total percentage **Demand** is a minimum.

APPENDIX 6 - PERFORMANCE REQUIREMENTS FOR CONTINUOUSLY ACTING AUTOMATIC EXCITATION CONTROL SYSTEMS FOR ONSHORE SYNCHRONOUS GENERATING UNITS

CC.A.6.1 Scope

CC.A.6.1.1 This Appendix sets out the performance requirements of continuously acting automatic excitation control systems for **Onshore Synchronous Generating Units** that must be complied with by the **GB Code User**. This Appendix does not limit any site specific requirements that may be included in a **Bilateral Agreement** where in **NGET's** reasonable opinion these facilities are necessary for system reasons.

CC.A.6.1.2 Where the requirements may vary the likely range of variation is given in this Appendix. It may be necessary to specify values outside this range where **NGET** identifies a system need, and notwithstanding anything to the contrary **NGET** may specify in the **Bilateral Agreement** values outside of the ranges provided in this Appendix 6. The most common variations are in the on-load excitation ceiling voltage requirements and the response time required of the **Exciter**. Actual values will be included in the **Bilateral Agreement**.

CC.A.6.1.3 Should a **GB Generator** anticipate making a change to the excitation control system it shall notify **NGET** under the **Planning Code** (PC.A.1.2(b) and (c)) as soon as the **GB Generator** anticipates making the change. The change may require a revision to the **Bilateral Agreement**.

CC.A.6.2 Requirements

CC.A.6.2.1 The **Excitation System** of an **Onshore Synchronous Generating Unit** shall include an excitation source (**Exciter**), a **Power System Stabiliser** and a continuously acting **Automatic Voltage Regulator (AVR)** and shall meet the following functional specification.

CC.A.6.2.2 In respect of **Onshore Synchronous Generating Units** with a **Completion Date** on or after 1 January 2009, and **Onshore Synchronous Generating Units** with a **Completion Date** before 1 January 2009 subject to a **Modification** to the excitation control facilities where the **Bilateral Agreement** does not specify otherwise, the continuously acting automatic excitation control system shall include a **Power System Stabiliser (PSS)** as a means of supplementary control. The functional specification of the **Power System Stabiliser** is included in CC.A.6.2.5.

CC.A.6.2.3 Steady State Voltage Control

CC.A.6.2.3.1 An accurate steady state control of the **Onshore Generating Unit** pre-set terminal voltage is required. As a measure of the accuracy of the steady-state voltage control, the **Automatic Voltage Regulator** shall have static zero frequency gain, sufficient to limit the change in terminal voltage to a drop not exceeding 0.5% of rated terminal voltage, when the **Onshore Generating Unit** output is gradually changed from zero to rated MVA output at rated voltage, **Active Power** and **Frequency**.

CC.A.6.2.4 Transient Voltage Control

CC.A.6.2.4.1 For a step change from 90% to 100% of the nominal **Onshore Generating Unit** terminal voltage, with the **Onshore Generating Unit** on open circuit, the **Excitation System** response shall have a damped oscillatory characteristic. For this characteristic, the time for the **Onshore Generating Unit** terminal voltage to first reach 100% shall be less than 0.5 seconds. Also, the time to settle within 5% of the voltage change shall be less than 3 seconds.

Formatted: Highlight

Formatted: Highlight

Formatted: Highlight

Formatted: Highlight

Formatted: Highlight

CC.A.6.2.4.2 To ensure that adequate synchronising power is maintained, when the **Onshore Generating Unit** is subjected to a large voltage disturbance, the **Exciter** whose output is varied by the **Automatic Voltage Regulator** shall be capable of providing its achievable upper and lower limit ceiling voltages to the **Onshore Generating Unit** field in a time not exceeding that specified in the **Bilateral Agreement**. This will normally be not less than 50 ms and not greater than 300 ms. The achievable upper and lower limit ceiling voltages may be dependent on the voltage disturbance.

CC.A.6.2.4.3 The **Exciter** shall be capable of attaining an **Excitation System On Load Positive Ceiling Voltage** of not less than a value specified in the **Bilateral Agreement** that will be:

not less than 2 per unit (pu)

normally not greater than 3 pu

exceptionally up to 4 pu

of **Rated Field Voltage** when responding to a sudden drop in voltage of 10 percent or more at the **Onshore Generating Unit** terminals. **NET** may specify a value outside the above limits where **NET** identifies a system need.

CC.A.6.2.4.4 If a static type **Exciter** is employed:

(i) the field voltage should be capable of attaining a negative ceiling level specified in the **Bilateral Agreement** after the removal of the step disturbance of CC.A.6.2.4.3. The specified value will be 80% of the value specified in CC.A.6.2.4.3. **NET** may specify a value outside the above limits where **NET** identifies a system need.

(ii) the **Exciter** must be capable of maintaining free firing when the **Onshore Generating Unit** terminal voltage is depressed to a level which may be between 20% to 30% of rated terminal voltage

(iii) the **Exciter** shall be capable of attaining a positive ceiling voltage not less than 80% of the **Excitation System On Load Positive Ceiling Voltage** upon recovery of the **Onshore Generating Unit** terminal voltage to 80% of rated terminal voltage following fault clearance. **NET** may specify a value outside the above limits where **NET** identifies a system need.

(iv) The requirement to provide a separate power source for the **Exciter** will be specified in the **Bilateral Agreement** if **NET** identifies a **Transmission System** need.

CC.A.6.2.5 **Power Oscillations Damping Control**

CC.A.6.2.5.1 To allow the **Onshore Generating Unit** to maintain second and subsequent swing stability and also to ensure an adequate level of low frequency electrical damping power, the **Automatic Voltage Regulator** shall include a **Power System Stabiliser** as a means of supplementary control.

CC.A.6.2.5.2 Whatever supplementary control signal is employed, it shall be of the type which operates into the **Automatic Voltage Regulator** to cause the field voltage to act in a manner which results in the damping power being improved while maintaining adequate synchronising power.

CC.A.6.2.5.3 The arrangements for the supplementary control signal shall ensure that the **Power System Stabiliser** output signal relates only to changes in the supplementary control signal and not the steady state level of the signal. For example, if generator electrical power output is chosen as a supplementary control signal then the **Power System Stabiliser** output should relate only to changes in generator electrical power output and not the steady state level of power output. Additionally the **Power System Stabiliser** should not react to mechanical power changes in isolation for example during rapid changes in steady state load or when providing frequency response.

CC.A.6.2.5.4 The output signal from the **Power System Stabiliser** shall be limited to not more than $\pm 10\%$ of the **Onshore Generating Unit** terminal voltage signal at the **Automatic Voltage Regulator** input. The gain of the **Power System Stabiliser** shall be such that an increase in the gain by a factor of 3 shall not cause instability.

- CC.A.6.2.5.5 The **Power System Stabiliser** shall include elements that limit the bandwidth of the output signal. The bandwidth limiting must ensure that the highest frequency of response cannot excite torsional oscillations on other plant connected to the network. A bandwidth of 0-5Hz would be judged to be acceptable for this application.
- CC.A.6.2.5.6 The **GB Generator** will agree **Power System Stabiliser** settings with **NGET** prior to the on-load commissioning detailed in BC2.11.2(d). To allow assessment of the performance before on-load commissioning the **GB Generator** will provide to **NGET** a report covering the areas specified in CP.A.3.2.1.
- CC.A.6.2.5.7 The **Power System Stabiliser** must be active within the **Excitation System** at all times when **Synchronised** including when the **Under Excitation Limiter** or **Over Excitation Limiter** are active. When operating at low load when **Synchronising** or **De-Synchronising** an **Onshore Generating Unit**, the **Power System Stabiliser** may be out of service.
- CC.A.6.2.5.8 Where a **Power System Stabiliser** is fitted to a **Pumped Storage Unit** it must function when the **Pumped Storage Unit** is in both generating and pumping modes.
- CC.A.6.2.6 Overall **Excitation System** Control Characteristics
- CC.A.6.2.6.1 The overall **Excitation System** shall include elements that limit the bandwidth of the output signal. The bandwidth limiting must be consistent with the speed of response requirements and ensure that the highest frequency of response cannot excite torsional oscillations on other plant connected to the network. A bandwidth of 0-5 Hz will be judged to be acceptable for this application.
- CC.A.6.2.6.2 The response of the **Automatic Voltage Regulator** combined with the **Power System Stabiliser** shall be demonstrated by injecting similar step signal disturbances into the **Automatic Voltage Regulator** reference as detailed in OC5A.2.2 and OC5.A.2.4. The **Automatic Voltage Regulator** shall include a facility to allow step injections into the **Automatic Voltage Regulator** voltage reference, with the **Onshore Generating Unit** operating at points specified by **NGET** (up to rated MVA output). The damping shall be judged to be adequate if the corresponding **Active Power** response to the disturbances decays within two cycles of oscillation.
- CC.A.6.2.6.3 A facility to inject a band limited random noise signal into the **Automatic Voltage Regulator** voltage reference shall be provided for demonstrating the frequency domain response of the **Power System Stabiliser**. The tuning of the **Power System Stabiliser** shall be judged to be adequate if the corresponding **Active Power** response shows improved damping with the **Power System Stabiliser** in combination with the **Automatic Voltage Regulator** compared with the **Automatic Voltage Regulator** alone over the frequency range 0.3Hz – 2Hz.
- CC.A.6.2.7 **Under-Excitation Limiters**
- CC.A.6.2.7.1 The security of the power system shall also be safeguarded by means of MVar **Under Excitation Limiters** fitted to the generator **Excitation System**. The **Under Excitation Limiter** shall prevent the **Automatic Voltage Regulator** reducing the generator excitation to a level which would endanger synchronous stability. The **Under Excitation Limiter** shall operate when the excitation system is providing automatic control. The **Under Excitation Limiter** shall respond to changes in the **Active Power** (MW) and the **Reactive Power** (MVar), and to the square of the generator voltage in such a direction that an increase in voltage will permit an increase in leading MVar. The characteristic of the **Under Excitation Limiter** shall be substantially linear from no-load to the maximum **Active Power** output of the **Onshore Generating Unit** at any setting and shall be readily adjustable.

CC.A.6.2.7.2 The performance of the **Under Excitation Limiter** shall be independent of the rate of change of the **Onshore Generating Unit** load and shall be demonstrated by testing as detailed in OC5.A.2.5. The resulting maximum overshoot in response to a step injection which operates the **Under Excitation Limiter** shall not exceed 4% of the **Onshore Generating Unit** rated MVA. The operating point of the **Onshore Generating Unit** shall be returned to a steady state value at the limit line and the final settling time shall not be greater than 5 seconds. When the step change in **Automatic Voltage Regulator** reference voltage is reversed, the field voltage should begin to respond without any delay and should not be held down by the **Under Excitation Limiter**. Operation into or out of the preset limit levels shall ensure that any resultant oscillations are damped so that the disturbance is within 0.5% of the **Onshore Generating Unit** MVA rating within a period of 5 seconds.

CC.A.6.2.7.3 The **GB Generator** shall also make provision to prevent the reduction of the **Onshore Generating Unit** excitation to a level which would endanger synchronous stability when the **Excitation System** is under manual control.

CC.A.6.2.8 Over-Excitation Limiters

CC.A.6.2.8.1 The settings of the **Over-Excitation Limiter**, where it exists, shall ensure that the generator excitation is not limited to less than the maximum value that can be achieved whilst ensuring the **Onshore Generating Unit** is operating within its design limits. If the generator excitation is reduced following a period of operation at a high level, the rate of reduction shall not exceed that required to remain within any time dependent operating characteristics of the **Onshore Generating Unit**.

CC.A.6.2.8.2 The performance of the **Over-Excitation Limiter**, where it exists, shall be demonstrated by testing as described in OC5.A.2.6. Any operation beyond the **Over-Excitation Limit** shall be controlled by the **Over-Excitation Limiter** without the operation of any **Protection** that could trip the **Onshore Generating Unit**.

CC.A.6.2.8.3 The **GB Generator** shall also make provision to prevent any over-excitation restriction of the generator when the **Excitation System** is under manual control, other than that necessary to ensure the **Onshore Generating Unit** is operating within its design limits.

APPENDIX 7 - PERFORMANCE REQUIREMENTS FOR CONTINUOUSLY ACTING AUTOMATIC VOLTAGE CONTROL SYSTEMS FOR ONSHORE NON-SYNCHRONOUS GENERATING UNITS, ONSHORE DC CONVERTERS, ONSHORE POWER PARK MODULES AND OTSDUW PLANT AND APPARATUS AT THE INTERFACE POINT

CC.A.7.1 Scope

CC.A.7.1.1 This Appendix sets out the performance requirements of continuously acting automatic voltage control systems for **Onshore Non-Synchronous Generating Units, Onshore DC Converters, Onshore Power Park Modules and OTSDUW Plant and Apparatus** at the **Interface Point** that must be complied with by the **GB Code User**. This Appendix does not limit any site specific requirements that may be included in a **Bilateral Agreement** where in **NGET's** reasonable opinion these facilities are necessary for system reasons.

CC.A.7.1.2 Proposals by **GB Generators** to make a change to the voltage control systems are required to be notified to **NGET** under the **Planning Code** (PC.A.1.2(b) and (c)) as soon as the **GB Generator** anticipates making the change. The change may require a revision to the **Bilateral Agreement**.

CC.A.7.2 Requirements

CC.A.7.2.1 **NGET** requires that the continuously acting automatic voltage control system for the **Onshore Non-Synchronous Generating Unit, Onshore DC Converter or Onshore Power Park Module or OTSDUW Plant and Apparatus** shall meet the following functional performance specification. If a **Network Operator** has confirmed to **NGET** that its network to which an **Embedded Onshore Non-Synchronous Generating Unit, Onshore DC Converter, Onshore Power Park Module or OTSDUW Plant and Apparatus** is connected is restricted such that the full reactive range under the steady state voltage control requirements (CC.A.7.2.2) cannot be utilised, **NGET** may specify in the **Bilateral Agreement** alternative limits to the steady state voltage control range that reflect these restrictions. Where the **Network Operator** subsequently notifies **NGET** that such restriction has been removed, **NGET** may propose a **Modification** to the **Bilateral Agreement** (in accordance with the **CUSC** contract) to remove the alternative limits such that the continuously acting automatic voltage control system meets the following functional performance specification. All other requirements of the voltage control system will remain as in this Appendix.

CC.A.7.2.2 Steady State Voltage Control

CC.A.7.2.2.1 The **Onshore Non-Synchronous Generating Unit, Onshore DC Converter, Onshore Power Park Module or OTSDUW Plant and Apparatus** shall provide continuous steady state control of the voltage at the **Onshore Grid Entry Point** (or **Onshore User System Entry Point** if **Embedded**) (or the **Interface Point** in the case of **OTSDUW Plant and Apparatus**) with a **Setpoint Voltage** and **Slope** characteristic as illustrated in Figure CC.A.7.2.2a. It should be noted that where the **Reactive Power** capability requirement of a directly connected **Onshore Non-Synchronous Generating Unit, Onshore DC Converter, Onshore Power Park Module** in Scotland, or **OTSDUW Plant and Apparatus** in Scotland as specified in CC.6.3.2 (c), is not at the **Onshore Grid Entry Point** or **Interface Point**, the values of Q_{min} and Q_{max} shown in this figure will be as modified by the 33/132kV or 33/275kV or 33/400kV transformer.

Formatted: Highlight

Formatted: Highlight

Formatted: Highlight

Formatted: Highlight

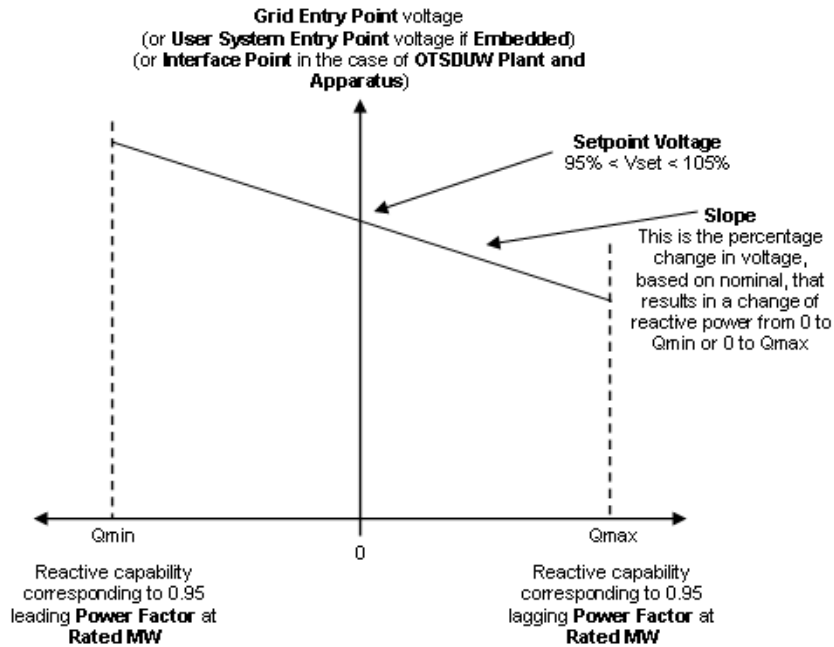

Figure CC.A.7.2.2a

CC.A.7.2.2.2 The continuously acting automatic control system shall be capable of operating to a **Setpoint Voltage** between 95% and 105% with a resolution of 0.25% of the nominal voltage. For the avoidance of doubt values of 95%, 95.25%, 95.5% ... may be specified, but not intermediate values. The initial **Setpoint Voltage** will be 100%. The tolerance within which this **Setpoint Voltage** shall be achieved is specified in BC2.A.2.6. For the avoidance of doubt, with a tolerance of 0.25% and a Setpoint Voltage of 100%, the achieved value shall be between 99.75% and 100.25%. **NGET** may request the **GB Generator** to implement an alternative **Setpoint Voltage** within the range of 95% to 105%. For **Embedded GB Generators** the **Setpoint Voltage** will be discussed between **NGET** and the relevant **Network Operator** and will be specified to ensure consistency with CC.6.3.4.

CC.A.7.2.2.3 The **Slope** characteristic of the continuously acting automatic control system shall be adjustable over the range 2% to 7% (with a resolution of 0.5%). For the avoidance of doubt values of 2%, 2.5%, 3% may be specified, but not intermediate values. The initial **Slope** setting will be 4%. The tolerance within which this **Slope** shall be achieved is specified in BC2.A.2.6. For the avoidance of doubt, with a tolerance of 0.5% and a **Slope** setting of 4%, the achieved value shall be between 3.5% and 4.5%. **NGET** may request the **GB Generator** to implement an alternative slope setting within the range of 2% to 7%. For **Embedded GB Generators** the **Slope** setting will be discussed between **NGET** and the relevant **Network Operator** and will be specified to ensure consistency with CC.6.3.4.

Formatted: Highlight

Formatted: Highlight

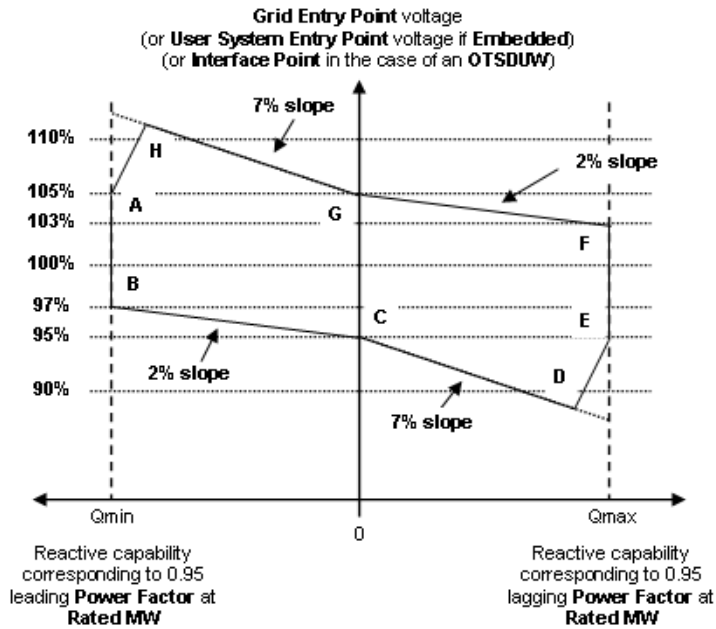

Figure CC.A.7.2.2b

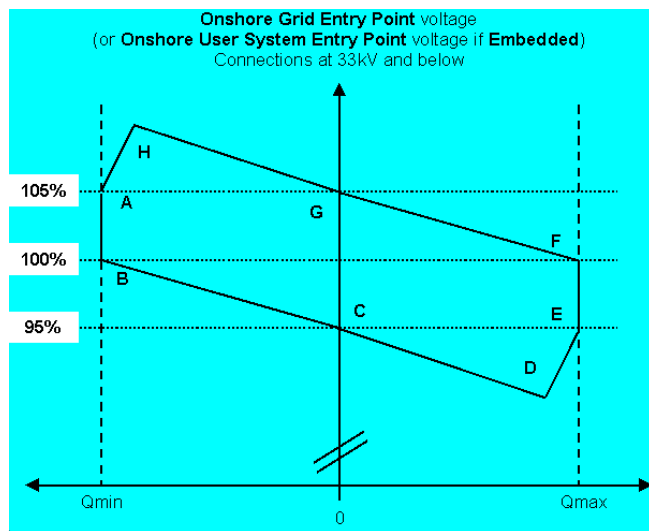

Figure CC.A.7.2.2c

Formatted: Highlight

Formatted: Highlight

Formatted: Highlight

Formatted: Highlight

CC.A.7.2.2.4 Figure CC.A.7.2.2b shows the required envelope of operation for **Onshore Non-Synchronous Generating Units, Onshore DC Converters, OTSDUW Plant and Apparatus and Onshore Power Park Modules** except for those **Embedded** at 33kV and below or directly connected to the **National Electricity Transmission System** at 33kV and below. Figure CC.A.7.2.2c shows the required envelope of operation for **Onshore Non-Synchronous Generating Units, Onshore DC Converters and Onshore Power Park Modules Embedded** at 33kV and below or directly connected to the **National Electricity Transmission System** at 33kV and below. Where the **Reactive Power** capability requirement of a directly connected **Onshore Non-Synchronous Generating Unit, Onshore DC Converter, OTSDUW Plant and Apparatus or Onshore Power Park Module** in Scotland, as specified in CC.6.3.2 (c), is not at the **Onshore Grid Entry Point or Interface Point** in the case of **OTSDUW Plant and Apparatus**, the values of Q_{min} and Q_{max} shown in this figure will be as modified by the 33/132kV or 33/275kV or 33/400kV transformer. The enclosed area within points ABCDEFGH is the required capability range within which the **Slope and Setpoint Voltage** can be changed.

CC.A.7.2.2.5 Should the operating point of the **Onshore Non-Synchronous Generating Unit, Onshore DC Converter, OTSDUW Plant and Apparatus or Onshore Power Park Module** deviate so that it is no longer a point on the operating characteristic (figure CC.A.7.2.2a) defined by the target **Setpoint Voltage and Slope**, the continuously acting automatic voltage control system shall act progressively to return the value to a point on the required characteristic within 5 seconds.

CC.A.7.2.2.6 Should the **Reactive Power** output of the **Onshore Non-Synchronous Generating Unit, Onshore DC Converter, OTSDUW Plant and Apparatus or Onshore Power Park Module** reach its maximum lagging limit at a **Onshore Grid Entry Point** voltage (or **Onshore User System Entry Point** voltage if **Embedded** or **Interface Point** in the case of **OTSDUW Plant and Apparatus**) above 95%, the **Onshore Non-Synchronous Generating Unit, Onshore DC Converter, OTSDUW Plant and Apparatus or Onshore Power Park Module** shall maintain maximum lagging **Reactive Power** output for voltage reductions down to 95%. This requirement is indicated by the line EF in figures CC.A.7.2.2b and CC.A.7.2.2c. Should the **Reactive Power** output of the **Onshore Non-Synchronous Generating Unit, Onshore DC Converter, OTSDUW Plant and Apparatus or Onshore Power Park Module** reach its maximum leading limit at a **Onshore Grid Entry Point** voltage (or **Onshore User System Entry Point** voltage if **Embedded** or **Interface Point** in the case of **OTSDUW Plant and Apparatus**) below 105%, the **Onshore Non-Synchronous Generating Unit, Onshore DC Converter, OTSDUW Plant and Apparatus or Onshore Power Park Module** shall maintain maximum leading **Reactive Power** output for voltage increases up to 105%. This requirement is indicated by the line AB in figures CC.A.7.2.2b and CC.A.7.2.2c.

CC.A.7.2.2.7 For Onshore Grid Entry Point voltages (or Onshore User System Entry Point voltages if Embedded or Interface Point voltages) below 95%, the lagging Reactive Power capability of the Onshore Non-Synchronous Generating Unit, Onshore DC Converter, OTSDUW Plant and Apparatus or Onshore Power Park Module should be that which results from the supply of maximum lagging reactive current whilst ensuring the current remains within design operating limits. An example of the capability is shown by the line DE in figures CC.A.7.2.2b and CC.A.7.2.2c. For Onshore Grid Entry Point voltages (or User System Entry Point voltages if Embedded or Interface Point voltages) above 105%, the leading Reactive Power capability of the Onshore Non-Synchronous Generating Unit, Onshore DC Converter, OTSDUW Plant and Apparatus or Onshore Power Park Module should be that which results from the supply of maximum leading reactive current whilst ensuring the current remains within design operating limits. An example of the capability is shown by the line AH in figures CC.A.7.2.2b and CC.A.7.2.2c. Should the Reactive Power output of the Onshore Non-Synchronous Generating Unit, Onshore DC Converter, OTSDUW Plant and Apparatus or Onshore Power Park Module reach its maximum lagging limit at an Onshore Grid Entry Point voltage (or Onshore User System Entry Point voltage if Embedded or Interface Point in the case of OTSDUW Plant and Apparatus) below 95%, the Onshore Non-Synchronous Generating Unit, Onshore DC Converter or Onshore Power Park Module shall maintain maximum lagging reactive current output for further voltage decreases. Should the Reactive Power output of the Onshore Non-Synchronous Generating Unit, Onshore DC Converter, OTSDUW Plant and Apparatus or Onshore Power Park Module reach its maximum leading limit at a Onshore Grid Entry Point voltage (or User System Entry Point voltage if Embedded or Interface Point voltage in the case of an OTSDUW Plant and Apparatus) above 105%, the Onshore Non-Synchronous Generating Unit, Onshore DC Converter, OTSDUW Plant and Apparatus or Onshore Power Park Module shall maintain maximum leading reactive current output for further voltage increases.

CC.A.7.2.2.8 All OTSDUW Plant and Apparatus must be capable of enabling GB Code Users undertaking OTSDUW to comply with an instruction received from NGET relating to a variation of the Setpoint Voltage at the Interface Point within 2 minutes of such instruction being received.

CC.A.7.2.2.9 For OTSDUW Plant and Apparatus connected to a Network Operator's System where the Network Operator has confirmed to NGET that its System is restricted in accordance with CC.A.7.2.1, clause CC.A.7.2.2.8 will not apply unless NGET can reasonably demonstrate that the magnitude of the available change in Reactive Power has a significant effect on voltage levels on the Onshore National Electricity Transmission System.

CC.A.7.2.3 Transient Voltage Control

CC.A.7.2.3.1 For an on-load step change in Onshore Grid Entry Point or Onshore User System Entry Point voltage, or in the case of OTSDUW Plant and Apparatus an on-load step change in Transmission Interface Point voltage, the continuously acting automatic control system shall respond according to the following minimum criteria:

(i) the Reactive Power output response of the Onshore Non-Synchronous Generating Unit, Onshore DC Converter, OTSDUW Plant and Apparatus or Onshore Power Park Module shall commence within 0.2 seconds of the application of the step. It shall progress linearly although variations from a linear characteristic shall be acceptable provided that the MVar seconds delivered at any time up to 1 second are at least those that would result from the response shown in figure CC.A.7.2.3.1a.

(ii) the response shall be such that 90% of the change in the Reactive Power output of the Onshore Non-Synchronous Generating Unit, Onshore DC Converter, OTSDUW Plant and Apparatus or Onshore Power Park Module, will be achieved within

- 1 second, where the step is sufficiently large to require a change in the steady state Reactive Power output from zero to its maximum leading value or maximum lagging value, as required by CC.6.3.2 (or, if appropriate, CC.A.7.2.2.6 or CC.A.7.2.2.7); and

- 2 seconds, for **Plant and Apparatus** installed on or after 1 December 2017, where the step is sufficiently large to require a change in the steady state **Reactive Power** output from its maximum leading value to its maximum lagging value or vice versa.

(iii) the magnitude of the **Reactive Power** output response produced within 1 second shall vary linearly in proportion to the magnitude of the step change.

(iv) within 2 seconds from achieving 90% of the response as defined in CC.A.7.2.3.1 (ii), the peak to peak magnitude of any oscillations shall be less than 5% of the change in steady state **Reactive Power**.

(v) following the transient response, the conditions of CC.A.7.2.2 apply.

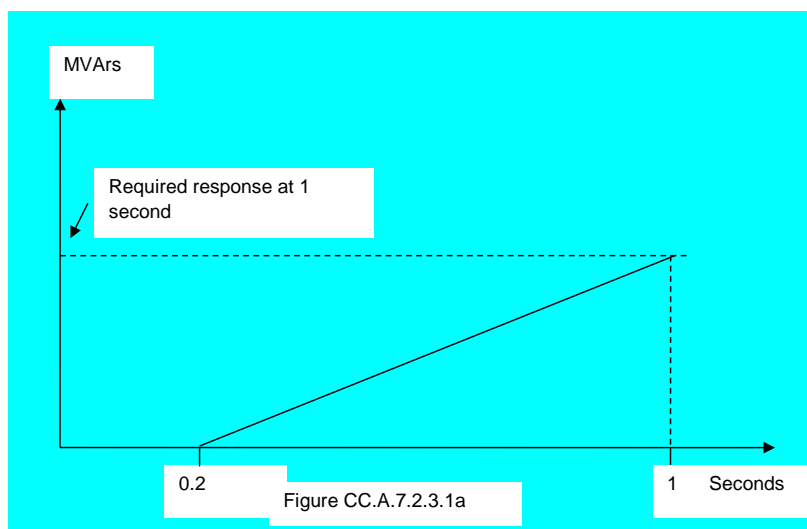

Formatted: Highlight

Formatted: Highlight

CC.A.7.2.3.2 An **Onshore Non-Synchronous Generating Unit, Onshore DC Converter, OTSDUW Plant and Apparatus** or **Onshore Power Park Module** installed on or after 1 December 2017 shall be capable of

(a) changing its **Reactive Power** output from its maximum lagging value to its maximum leading value, or vice versa, then reverting back to the initial level of **Reactive Power** output once every 15 seconds for at least 5 times within any 5 minute period; and

(b) changing its **Reactive Power** output from zero to its maximum leading value then reverting back to zero **Reactive Power** output at least 25 times within any 24 hour period and from zero to its maximum lagging value then reverting back to zero **Reactive Power** output at least 25 times within any 24 hour period. Any subsequent restriction on reactive capability shall be notified to **NGET** in accordance with BC2.5.3.2, and BC2.6.1.

In all cases, the response shall be in accordance to CC.A.7.2.3.1 where the change in **Reactive Power** output is in response to an on-load step change in **Onshore Grid Entry Point** or **Onshore User System Entry Point** voltage, or in the case of **OTSDUW Plant and Apparatus** an on-load step change in **Transmission Interface Point** voltage.

CC.A.7.2.4 **Power Oscillation Damping**

CC.A.7.2.4.1 The requirement for the continuously acting voltage control system to be fitted with a **Power System Stabiliser (PSS)** shall be specified in the **Bilateral Agreement** if, in **NGET's** view, this is required for system reasons. However if a **Power System Stabiliser** is included in the voltage control system its settings and performance shall be agreed with **NGET** and commissioned in accordance with BC2.11.2. To allow assessment of the performance before on-load commissioning the **GB Generator** will provide to **NGET** a report covering the areas specified in CP.A.3.2.2.

CC.A.7.2.5 **Overall Voltage Control System Characteristics**

CC.A.7.2.5.1 The continuously acting automatic voltage control system is required to respond to minor variations, steps, gradual changes or major variations in **Onshore Grid Entry Point** voltage (or **Onshore User System Entry Point** voltage if **Embedded** or **Interface Point** voltage in the case of **OTSDUW Plant and Apparatus**).

CC.A.7.2.5.2 The overall voltage control system shall include elements that limit the bandwidth of the output signal. The bandwidth limiting must be consistent with the speed of response requirements and ensure that the highest frequency of response cannot excite torsional oscillations on other plant connected to the network. A bandwidth of 0-5Hz would be judged to be acceptable for this application. All other control systems employed within the **Onshore Non-Synchronous Generating Unit, Onshore DC Converter, OTSDUW Plant and Apparatus** or **Onshore Power Park Module** should also meet this requirement.

CC.A.7.2.5.3 The response of the voltage control system (including the **Power System Stabiliser** if employed) shall be demonstrated by testing in accordance with OC5A.A.3.

< END OF CONNECTION CONDITIONS >

GC0104

DRAFT DEMAND RESPONSE SERVICES CODE - LEGAL TEXT

DATED 23/04/2018

**DEMAND RESPONSE SERVICES CODE
(DRS)**

CONTENTS

(This contents page does not form part of the Grid Code)

<u>Paragraph No/Title</u>	<u>Page Number</u>
<u>DRSC.1 INTRODUCTION</u>	
<u>DRSC.2 OBJECTIVE</u>	
<u>DRSC.3 SCOPE</u>	
<u>DRSC.4 GENERAL PROVISIONS</u>	
<u>DRSC.5 SPECIFIC PROVISIONS FOR DEMAND UNITS WITH DEMAND RESPONSE ACTIVE POWER CONTROL AND TRANSMISSION CONSTRAINT MANAGEMENT</u>	
<u>DRSC.6 SPECIFIC PROVISIONS FOR DEMAND UNITS WITH DEMAND RESPONSE FREQUENCY CONTROL</u>	
<u>DRSC.7 SPECIFIC PROVISIONS FOR DEMAND UNITS WITH DEMAND RESPONSE VERY FAST ACTIVE POWER CONTROL</u>	
<u>DRSC.8 DATA REQUIRED BY NGET FROM DEMAND RESPONSE PROVIDER'S</u>	
<u>DRSC.9 OPERATIONAL METERING REQUIREMENTS</u>	
<u>DRSC.10 INSTRUCTIONS ISSUED TO DEMAND RESPONSE PROVIDER'S</u>	
<u>DRSC.11 OPERATIONAL NOTIFICATION PROCEDURE</u>	
<u>DRSC.11.34 COMPLIANCE</u>	
<u>DRSC.11.45 COMPLIANCE TESTING</u>	
<u>DRSC.11.56 COMPLIANCE TESTING FOR DEMAND RESPONSE PROVIDER'S WITH DEMAND RESPONSE ACTIVE POWER CONTROL, REACTIVE POWER CONTROL AND TRANSMISSION CONSTRAINT MANAGEMENT</u>	
<u>DRSC.11.67 COMPLIANCE SIMULATION</u>	
<u>DRSC.11.78 COMPLIANCE SIMULATIONS FOR DEMAND UNITS WITH DEMAND RESPONSE VERY FAST ACTIVE POWER CONTROL</u>	
<u>DRSC.9 GOVERNANCE OF BALANCING SERVICES PRINCIPLES IN ACCORDANCE WITH THE PROCUREMENT GUIDELINES</u>	

Formatted: Tab stops: 2.25 cm, Left + Not at 2.5 cm

Formatted: Tab stops: 2.25 cm, Left

Formatted: Indent: Left: 0 cm, Hanging: 2.25 cm, Tab stops: 2.25 cm, Left + Not at 2.5 cm

Formatted: Tab stops: 2.25 cm, Left + Not at 2.5 cm

Formatted: Indent: Left: 0 cm, Hanging: 2.25 cm, Tab stops: 2.25 cm, Left + Not at 2.5 cm

Formatted: Tab stops: 2.25 cm, Left + Not at 2.5 cm

APPENDIX I - DRSC.A.2 - SUMMARY OF DEMAND RESPONSE SERVICES AND BALANCING SERVICES

Formatted: Font: Not Bold, Not Highlight

APPENDIX II - DRSC.A.21 - PART II - DEMAND RESPONSE UNIT DOCUMENT (DRUD) STATEMENT OF COMPLIANCE FOR DEMAND RESPONSE PROVIDER'S

Formatted: Font: Not Bold, Not Highlight

Formatted: Font: Calibri, Not Bold

Formatted: Font: Not Bold, Not Highlight

PART I

DRSC.1 **INTRODUCTION**

DRSC.1.1 The **Demand Response Services Code** is concerned with ~~the technical requirements of any Demand Response Side Providers who wishes to~~ contract with NGET for the provision of **Commercial Ancillary Services**.

DRSC.1.2 **Commercial Ancillary Services** are non-mandatory services used by NGET in operating the **Total System**. They are provided by **Demand Response Providers** with payment being dealt with under the terms of the relevant agreement for the **Ancillary Service**.

DRSC.1.3 ~~Ancillary Services form part of NGET's Balancing Services. Where a Demand Response Provider is interested in offering an Ancillary Service to NGET, then further details and additional information of the Ancillary Services are available as part of NGET's Balancing Services are available from the Balancing Services section of the Website.~~

DRSC.1.4 ~~Where NGET and a Demand Response Provider enter into an Ancillary Services agreement, it shall be in accordance with Transmission Licence condition C16 and the Standard Contract Terms. An example of the Standard Contract Terms are available under the Balancing Services section of the Website. The commercial arrangements applicable to Demand Side Providers are defined in the relevant agreement with the technical and compliance requirements being defined in this Demand Response Services Code.~~

DRSC.1.5.4 ~~This Demand Response Services Code is designed to complement the arrangements which would form part of an Ancillary Services agreement between a Demand Response Provider and NGET whilst also and to discharge discharging the obligations under European Regulation (EU) 2016/1388. As a condition of the The Ancillary Services Agreement (which shall be in accordance with Transmission Licence Condition C16 and the Standard Contract Terms), there will be include an obligation on the Demand Response Provider requirement to satisfy the applicable requirements of this Demand Response Services Code.~~

DRSC.1.6 The **Demand Response Code** applies only to **Demand Response Providers** who have ~~entered into an agreement contracted with~~ NGET to provide **an Ancillary Services**. This **Demand Response Services Code Code** does not apply to **Users who are not Demand Response Providers** ~~EU Code Users who have not entered into an agreement to provide Ancillary Services.~~

DRSC.1.7.5 For the avoidance of doubt, ~~EU Code Users in respect of Network Operators and Non Embedded Customers in respect of EU Grid Supply Points are only~~ required to satisfy the compliance requirements ~~specified in the European Compliance Processes (ECPs) and not those defined~~ in section DRSC.11 of this code ~~in addition to the European Compliance Processes only if they are also a Demand Response Provider. In the case of a Non Embedded Customer, the requirements of this DRSC would only apply if they were also a~~ unless they are also a **Demand Response Provider**.

DRSC.2 **OBJECTIVE**

The objectives of the **DRSC** are to: ~~Detail the~~

DRSC.2.1 **Ensure the obligations of European Regulation (EU) 2016/1388 have been discharged; and**

Formatted: Font: Bold

Formatted: Font: Bold

Formatted: Font: Bold

Formatted: Font: Bold

Formatted: Font: Bold

Formatted: Font: Bold

Formatted: Font: Bold

Formatted: Font: Bold

Formatted: Font: Bold

Formatted: Font: Bold

Formatted: Font: Bold

Formatted: Font: Bold

Formatted: Font: Bold

Formatted: Font: Bold

Formatted: Font: Bold

Formatted: Font: Bold

Formatted: Font: Bold

Formatted: Font: Not Bold

Formatted: Font: Not Bold

Formatted: Font: Not Bold

Formatted: Font: Bold

Formatted: Font: Bold

Formatted: Font: Bold

Formatted: Font: Bold

Formatted: Font: Bold

Formatted: Font: Bold

Formatted: Indent: Left: 0 cm, First line: 0 cm

Formatted: Font: Bold

Formatted: Font: Not Bold

Formatted: Font: Not Bold

Formatted: Font: Bold

Formatted: Font: Not Bold

Formatted: Font: Not Bold

Formatted: Font: Bold

Formatted: Font: Bold

Formatted: Font: Bold

Formatted: Font: Bold

Formatted: Font: Bold

Formatted: Font: Bold

~~DRSC.2.2~~ Complement the requirements of the **Ancillary Services** agreement between **NGET** and a **Demand Response Provider**; and

Formatted: Font: Bold

~~DRSC.2.3~~ Define the minimum technical, ~~data submission~~ and compliance requirements, **Demand Response Side Providers** are required to satisfy if they ~~enter~~ provide a **Demand Response Service** to **NGET** under an **Ancillary Services** agreement, in accordance with the terms of an ~~into an agreement for Ancillary Services~~ **Agreement with NGET** and:

Formatted: Font: Bold

Formatted: Font: Bold

Formatted: Font: Bold

Formatted: Font: Not Bold

Formatted: Font: Bold

Formatted: Font: Bold

Formatted: Font: Not Bold

Formatted: Font: Not Bold

Formatted: Font: Not Bold

Formatted: Font: Bold

~~DRSC.2.2~~ Ensure the obligations of **European Regulation (EU) 2016/1388** have been discharged.

DRSC.3 **SCOPE**

DRSC.3.1 The **DRSC** applies to ~~NGET~~ and to **Demand Response Providers** which in this **DRSC** means:

(a) ~~Non-Embedded Customers~~ who are defined as an **EU Code User** and have an agreement with **NGET** to provide **Ancillary Services**.

(b) ~~a~~ Any **Demand Response Provider** party who has entered into an agreement to provide **Ancillary Services** with **NGET** ~~from a Demand Facility~~.

Formatted: Font: Bold

DRSC.3.2 The **DRSC** does not apply to Users or parties who are not a Demand Response Provider's:

Formatted: Font: Bold

(a) ~~Any EU Code User which does not have an agreement with NGET to provide Ancillary Services; or~~

Formatted: Font: Bold

(b) ~~Network Operators or~~

Formatted: Font: Not Bold

(c) ~~GB Code Users~~

DRSC.4 **GENERAL PROVISIONS**

DRSC.4.1 ~~Demand Response Services Providers who have an agreement with NGET to provide Ancillary Services~~ shall be based on the following categories.

(a) Controlled by instruction from **NGET**

(i) **Demand Response Active Power Control**

(ii) **Demand Response Reactive Power Control**

(iii) **Demand Response Transmission Constraint Management**

(b) Automatic operation once the facility has been instructed into operation upon instruction from **NGET** pursuant to the terms of the **Ancillary Services** agreement.

(i) **Demand Response System Frequency Control**

(ii) **Demand Response Very Fast Active Power Control**

Formatted: Font: Bold

Formatted: Font: Calibri, 11 pt

Formatted: Font: Bold

Formatted: Font: Calibri, 11 pt, Bold

Formatted: Font: Calibri, 11 pt

Formatted: Font: Bold

Formatted: Font: Calibri, 11 pt, Bold

Formatted: Font: Calibri, 11 pt

Formatted: Font: Not Bold

Formatted: Font: Bold

Formatted: Font: Not Bold

Formatted: Font: Not Bold

Formatted: Font: Bold

Formatted: Font: Bold

Formatted: Font: Bold

Formatted: Font: Not Bold

Formatted: Font: Bold

Formatted: Font: Not Bold

~~DRSC.4.2~~ **NGET** procure a range of **Balancing Services** to balance **Demand** and supply. ~~DRSC.4.1 defines how these Balancing Services fit into the categories defined in DRSC.4.1.~~

DRSC.4.32 **Demand Response Providers** who own, operate, or control or manage ~~with Plant and Apparatus or Demand Unit(s)~~ within a **Demand Facility** and/or **Closed Distribution System(s)**, which constitute all or part of a **Demand Response Provider** or on an aggregated basis may provide **Demand Response Services** to **NGET**. **Demand Response Providers** can offer **Demand Response Services** on an individual or collective basis and increase or decrease their **Demand** in accordance with the terms of their **Ancillary Services** agreement.

Formatted: Justified

DRSC.4.43 The **Demand Response Services** specified in DRSC.4.1 are not exclusive and do not preclude

~~Demand Response Providers~~ from negotiating other services with NGET. These ~~services~~ requirements would be pursuant to the terms of the Ancillary Services agreement. ~~DRSC.A.1 provides a summary of NGET's Balancing Services.~~

Formatted: Font: Not Bold

Formatted: Font: Not Bold

Formatted: Font: Not Bold

DRSC.5 SPECIFIC PROVISIONS FOR DEMAND UNITS WITH DEMAND RESPONSE ACTIVE POWER CONTROL AND TRANSMISSION CONSTRAINT MANAGEMENT

DRSC.5.1 Where a Demand Response Provider ~~(including Demand Facilities or Closed Distribution Systems)~~ provides Demand Response Active Power Control, Demand Response Reactive Power Control or Demand Response Transmission Constraint Management to NGET, then the following requirements as detailed below shall apply. For the avoidance of doubt these requirements shall apply either individually or where it is not part of a Demand Facility, collectively as part of a Demand Aggregation scheme through a Demand Response Provider. Demand Response Providers shall ensure that any ~~of their Plant and Apparatus Demand Unit which they own, operate, control or manage and which is used to~~ which provides the Demand Response Services as detailed in DRSC.5.1 shall:-

Formatted: Font: Bold

Formatted: Font: Not Bold

Formatted: Font: Not Bold

Formatted: Font: Bold

- (a) Be capable of satisfying the Frequency range requirements as specified in ECC.6.1.2.1.
- (b) Be capable of satisfying the voltage range requirements as specified in ECC.6.1.4.1.
- (c) Be capable of controlling the power consumption from the Total System in accordance with the terms of the Ancillary Services agreement.
- (d) Be capable of receiving instructions from NGET either directly or through a third party to modify their demand in accordance with the Demand Response Service they have agreed to provide, terms of the Ancillary Services agreement. ~~The requirements for data transfer shall be in accordance with the requirements of DRSC.5. For Demand Units connected at a voltage level below 110kV, the same requirements shall apply as those applicable to Demand Response Providers who are not Users.~~
- (e) Be capable of adjusting its ~~Real Power or Reactive Power flow consumption~~ within a time period pursuant to the terms of the Ancillary Services agreement.
- (f) Be capable of full execution of an instruction issued by NGET to modify its power ~~flow consumption in accordance with the requirements of the Ancillary Services agreement.~~
- (g) Be capable of further demand changes as instructed by NGET, ~~prior to following the execution of~~ a previous instruction ~~having been~~ issued by NGET ~~where specified in accordance with~~ the Ancillary Services agreement. Any such instruction shall not exceed the normal safe operating conditions of the Demand Response Provider's Plant and Apparatus or Demand Unit(s) which could cause such equipment to trip. Instructions to modify ~~Active Power or Reactive Power flow consumption~~ may have immediate or delayed effects but in any event would need to comply with the requirements of the Ancillary Services agreement.
- (h) Notify NGET of any change in the available capacity in accordance with the relevant Ancillary Services agreement.
- (i) Be capable of withstanding a rate of change of System Frequency of up to a maximum of 1Hz/s measured over a 500ms time frame.

Formatted: Font: Bold

Formatted: Not Highlight

Formatted: Font: Bold

Formatted: Font: Bold

Formatted: Font: Not Bold

Formatted: Font: Bold

Formatted: Font: Bold

Formatted: Font: Bold

Formatted: Font: Bold

DRSC.5.2 In addition to the requirements of DRSC.5.1, where a **Demand Response Provider** automatically modifies its **Demand** in response to changes in **System Frequency** or **System** voltage or both, **NGET** will ~~have~~ previously ~~have~~ instructed the **Demand Response Provider** to switch these facilities into service in accordance with the terms of the **Ancillary Services** agreement prior to any automatic action taking place. The ability for **NGET** to issue instructions, receive acknowledgement of those instructions and receive operational metering data (for example voltage, current, **Active Power** and **Reactive Power** signals) from the **Demand Response Provider** will be dependent upon the type of **Demand Response Service** provided and shall be defined in the **Ancillary Services** agreement which shall be pursuant to the **Standard Contract Terms**, ~~are defined in DRSC.10X.~~

Formatted: Font: Not Bold

Formatted: Font: Not Bold

Formatted: Font: Not Bold

DRSC.5.3 **Non Embedded Customers** ~~s who are also **Demand Response Provider**s~~ shall be capable of ~~providing~~ **Demand Response Reactive Power Control** by switching static compensation equipment into or out of service, ~~in accordance with the terms of the **Ancillary Services** agreement.~~ This service could be provided by the **Non-Embedded Customer** either directly or indirectly as part of a demand aggregation scheme through a third party in response to an instruction from **NGET** and pursuant to the terms of the **Ancillary Services** agreement.

Formatted: Font: Not Bold

Formatted: Font: Not Bold

Formatted: Font: Not Bold

Formatted: Font: Bold

Formatted: Not Highlight

Formatted: Font: Not Bold

Formatted: Font: Not Bold

Formatted: Font: Not Bold

~~DRSC.5.4~~ Part I of DRSC.A.1 lists the categories of **Bbalancing Sservices** that a **Demand Response Provider** who offers **Demand Response Active Power Control**, **Demand Response Reactive Power Control** or **Demand Response Transmission Constraint Management** may offer to **NGET**. Part II of DRSC.A.1 details the specific requirements for each of these **Bbalancing Sservices** provides

Formatted: Font: Bold

Formatted: Font: Bold

Formatted: Font: Bold

Formatted: Font: Bold

DRSC.6 SPECIFIC PROVISIONS FOR DEMAND UNITS WITH DEMAND RESPONSE FREQUENCY CONTROL

DRSC.6.1 Where a ~~User or~~ **Demand Response Provider** ~~(including **Demand Facilities** or **Closed Distribution Systems**)~~ provides **Demand Response System Frequency Control** to **NGET**, then the following requirements as detailed below shall apply. For the avoidance of doubt, these requirements ~~shall~~ apply either individually or where it is not part of a ~~**Non-Embedded Customers System Demand Facility**~~, collectively as part of a **Demand Aggregation** scheme through a **Demand Response Provider**. **Demand Response Providers** shall ensure that any of their **Plant** and **Apparatus** or **Demand Unit(s)** which they own, operate, control or manage, and which is used to which provides the **Demand Response System Frequency Control Services** as detailed in DRSC.6.1 shall:-

Formatted: Font: Bold

Formatted: Font: Not Bold

Formatted: Font: Not Bold

Formatted: Font: Bold

Formatted: Font: Bold

Formatted: Not Highlight

Formatted: Font: Bold

Formatted: Font: Bold

Formatted: Font: Bold

Formatted: Font: Bold

Formatted: Not Highlight

Formatted: Not Highlight

Formatted: Not Highlight

Formatted: Font: Not Bold

Formatted: Not Highlight

Formatted: Font: Bold

Formatted: Font: Bold, Not Highlight

Formatted: Font: Bold

Formatted: Font: Bold, Not Highlight

Formatted: Not Highlight

- (a) Be capable of satisfying the **Frequency** range requirements as specified in ECC.6.1.2.1.
- (b) Be capable of satisfying the voltage range requirements as specified in ECC.6.1.4.1.
- (c) Be fitted with a deadband facility no greater than 0.03Hz unless otherwise specified in the **Ancillary Services** agreement. This requirement shall not apply to **Demand Response Side Providers** where only a **Non-Dynamic Frequency Response Service** is provided.
- (d) ~~Be capable of continuous operation.~~ The envelope of operation of the **Demand Response System Frequency Control** shall be in accordance with the terms of the **Ancillary Services** agreement ~~and consistent with **NGET's Bbalancing Sservices**.~~ For the avoidance of doubt, ~~continuous operation~~ would not be required in respect of ~~apply to a static **Frequency Response service**, **Non-Dynamic Frequency Response Service**, is~~ are required to be capable of repeating their capability within 5 minutes.

(e) Be fitted with a control system which is capable of responding to changes in **System Frequency** outside the nominal value limits of 50Hz. A deadband either side of nominal frequency shall be permitted which shall be deadband in accordance with the requirement of the **Ancillary Services** agreement.

Formatted: Font: Bold

Formatted: Not Highlight

(f) Be equipped with a controller that measures the actual **System Frequency**. The refresh rate for this controller shall be no longer than 0.2 seconds.

(g) Be able to detect a change in **System Frequency** of 0.01Hz. Each Demand Unit owned, or operated, controlled or managed by a Demand Response Provider shall be capable of a rapid detection and response to changes in **System Frequency** which shall be pursuant to the terms of the **Ancillary Services** agreement. An offset in the steady state measurement of **Frequency** shall be acceptable up to 0.05Hz. **Frequency** measurements must be recorded at each Demand Facility site and must not be derived on an aggregated basis.

Formatted: Font: Bold

Formatted: Font: Bold

Formatted: Not Highlight

Formatted: Font: Bold

~~DRSC.6.2 Part I of DRSC.A.1 lists the categories of Balancing Services that a Demand Response Provider who offers Demand Response System Frequency Control may offer to NGET. Part II of DRSC.A.1 details the specific requirements for each of these Balancing Services.~~

Formatted: Font: Bold

Formatted: Font: Bold

DRSC.7 SPECIFIC PROVISIONS FOR DEMAND UNITS WITH DEMAND RESPONSE VERY FAST ACTIVE POWER CONTROL

DRSC.7.1 Where a **Demand Response Provider** provides **Demand Response Very Fast Active Power Control** to NGET, then the applicable requirements shall be pursuant to the terms of the **Ancillary Services** agreement which shall specify:-

(a) The relationship between the change in **Active Power** and the rate of change of **System Frequency** over the **Demand** range of the **Demand Response Provider's Demand Unit(s) Plant and Apparatus**, which they own, operate, control or manage.

Formatted: Font: Not Bold

Formatted: Font: Not Bold

Formatted: Font: Not Bold

(b) The operating principles of the **Demand Response Very Fast Active Power Control** and associated performance parameters.

(c) The response time of the **Demand Response Very Fast Active Power Control** which shall be no longer than 2 seconds from the inception of the **System Frequency** change.

~~DRSC.7.2 Part I of DRSC.A.1 lists the categories of balancing services that a Demand Response Provider who offers Demand Response Very Fast Active Power Control may offer to NGET. Part II of DRSC.A.1 details the specific requirements for each of these Balancing Services.~~

Formatted: Font: Bold

DRSC.8 DATA REQUIRED BY NGET FROM DEMAND RESPONSE PROVIDER'S

Formatted: Tab stops: 2.25 cm, Left + Not at 2.5 cm

DRSC.8.1 The data required to be submitted to NGET by a Demand Response Provider will vary depending upon the type of contracted Demand Response Service provided and will be set out in the. All Demand Response Providers who have a contract with NGET to provide Demand Response Services are required to provide the data required pursuant to the terms of the in accordance with the terms of the Ancillary Services agreement, which shall be consistent with those defined in the Standard Contract Terms. The data required to be submitted to NGET will vary depending upon the type of Balancing Service and the requirements of the Ancillary Service agreement. DRSC.A.1 Part II, provides additional information on the type of data that would be required in respect of each Balancing Service which would be pursuant to the Standard Contract Terms.

Formatted: Font: Bold

Formatted: Font: Not Bold

Formatted: Font: Bold

Formatted: Font: Bold

Formatted: Font: Bold

Formatted: Font: Bold

Formatted: Font: Bold

Formatted: Font: Not Bold

DRSC.9 OPERATIONAL METERING REQUIREMENTS

DRSC.9.1 The operational metering data required to be submitted to NGET will vary depending upon

~~the type of contracted Demand Response Service provided. Demand Response Providers's who have a contract with NGET to provide Demand Response Services are may be required only to install such operational metering equipment where specified in accordance with the Ancillary Services agreement.~~

Formatted: Font: Not Bold

Formatted: Font: Not Bold

~~All Demand Response Providers who have a contract with NGET to provide Demand Response Services are required to supply operational metering data to NGET for the purposes of facilitating the Demand Response Service.~~

~~DRSC.9.2 In addition to the requirements of DRSC.9.1, Demand Side Providers are required to supply operational metering signals to NGET pursuant to the terms of the Ancillary Services agreement. These requirements would be consistent with the requirements in the Standard Contract Terms and will vary depending upon the type of Ancillary Service.~~

Formatted: Font: Bold

Formatted: Font: Bold

Formatted: Indent: Left: 0 cm, First line: 0 cm

DRSC.10 INSTRUCTIONS ISSUED TO DEMAND RESPONSE PROVIDER'S

~~DRSC.10.1 To enable NGET to instruct Demand Response Providers's in the operational environment, the requirement for Demand Response Providers may be required to be fitted with communication and instruction facilities to enable NGET to instruct them in the operational timeframe. These requirements will vary depending upon the type of Demand Response Service provided and will be set out in the Demand Response Providers who have a contract with NGET to provide Demand Response Services are required only to install such facilities where specified in the Ancillary Services agreement.~~

Formatted: Font: Not Bold

Formatted: Font: Bold

Formatted: Font: Bold

~~shall be in accordance with the terms of the Ancillary Services agreement. These requirements would be consistent with the requirements in the Standard Contract Terms and will vary depending upon the type of Ancillary Service.~~

Formatted: Font: Bold

Formatted: Font: Bold

Formatted: Indent: Left: 0 cm, First line: 0 cm

PART II

COMPLIANCE REQUIREMENTS FOR DEMAND RESPONSE SERVICES

DRSC.11 OPERATIONAL NOTIFICATION PROCEDURE

DRSC.11.1 General Provisions

DRSC.11.1.1 ~~All Demand Response Providers~~^s who enter into an agreement with NGET to provide **Ancillary Services** are required to undertake a compliance process to ensure the **Demand Response Providers Plant and Apparatus** or Demand Unit(s) which they own, operate, control or manage, satisfies the requirements of the **Ancillary Services** agreement and the Demand Response Services Code. For the avoidance of doubt, **Demand Response Providers**^s who are also **EU Code Users**^s, will also be required to satisfy the requirements of the applicable requirements of the **European Compliance Processes (ECP's)**.

Formatted: Indent: Left: 0 cm, First line: 0 cm

Formatted: Font: Not Bold

Formatted: Font: Bold

Formatted: Font: Bold

Formatted: Font: Not Bold

Formatted: Font: Bold

Formatted: Font: Not Bold

Formatted: Font: Not Bold

~~DRSC.11.1.2 The operational notification procedure applicable to Demand Response Providers are split into the following categories dependent upon the following criteria:~~

~~(a) Demand Response Providers Plant and Apparatus connected to the Total System at a nominal System voltage of 1000 Volts or less; or (Not Required - Remove 1000V not used in GB no network connection)~~

Formatted: Not Highlight

~~(b) Demand Response Providers Plant and Apparatus connected to the Total System at a nominal System voltage of greater than 1000 Volts.~~

DRSC.11.1.23 Each **Demand Response Provider**, shall confirm to **NGET** its ability to comply with the requirements of the **Ancillary Services** agreement.

DRSC.11.1.34 Each **Demand Response Provider** shall notify **NGET** of any change ~~to its~~ to the Plant or **Apparatus** ~~which they own, operates, controls or manages~~ such ~~they are~~ it is no longer able to satisfy the conditions specified in the **Ancillary Services** agreement and/or the relevant provisions of the DRSC. Such changes shall be notified to **NGET** in accordance with the terms of the **Ancillary Services** agreement.

Formatted: Font: Bold

~~DRSC.11.2 Procedures for Demand Response Providers Plant and Apparatus connected to the Total System at a nominal System voltage of 1000 Volts or less~~

Formatted: Not Highlight

~~DRSC.11.2.1 The operational notification procedure for a Demand Response Provider whose Plant and Apparatus is connect to the Total System at a nominal System voltage of 1000 volts or less shall comprise an Installation Document.~~

~~DRSC.11.2.2 The format of the Installation Document shall take the format shown in DRSC.A.1. This shall not preclude the requirements for additional information or data which would be pursuant to the terms of the Ancillary Services agreement.~~

~~DRSC.11.2.3 Demand Response Providers should submit the data required in the Installation Document to NGET. NGET shall only initiate the Demand Response Service as defined in the Ancillary Services agreement once the required data has been submitted. The Installation Document~~

shall differentiate between different types of connection and between different categories of Demand Response Service.

~~DRSC.11.2.4 Demand Response Providers are required to supply a separate Installation Document in respect of each Demand Unit.~~

~~DRSC.11.2.5 As part of this operational notification process, NGET may aggregate the Installation Documents supplied by a Demand Response Provider in respect of their Demand Units.~~

~~DRSC.11.2.6 The Installation Document shall contain but not limited to the following items:-~~

- ~~(a) The location at which the Demand Unit is connected to the System.~~
- ~~(b) The Maximum Import Capability and Maximum Export Capability of the Demand Unit in kW.~~
- ~~(c) The type of Demand Response Services provided.~~
- ~~(d) The Demand Unit certificate or Equipment Certificate or equivalent information as agreed by NGET.~~
- ~~(e) Contact details of the Demand Response Provider.~~

Formatted: Indent: Left: 0 cm

~~DRSC.11.23 Operational Notification Procedures for Demand Response Providers's Plant and Apparatus connected to the Total System at a nominal System voltage above 1000 Volts~~

~~DRSC.11.23.1 The operational notification procedure for a All Demand Response Providers's are required to undertake an Operational Notification procedure which whose Plant and Apparatus is connecting to the Total System at a nominal System voltage of above 1000 volts shall comprise a Demand Response Unit Document (DRUD).~~

Formatted: Font: Not Bold

Formatted: Font: Bold

~~DRSC.11.23.2 The format of the Demand Response Unit Document (DRUD) shall take the format shown in DRSC.A.12 and shall provide sufficient information to demonstrate the Demand Response Provider's Plant and Apparatus or Demand Unit(s) which a Demand Response Provider owns, operates, controls or manages, is capable of satisfying the full requirements of the Ancillary Services agreement and the applicable requirements of the DRSC. The compliance requirements can be simplified to a single operational notification stage as well as be reduced as agreed with NGET. Demand Response Providers's shall be required to submit a new DRUD for each subsequent Demand Unit added to its portfolio/fleet.~~

Formatted: Not Highlight

Formatted: Not Highlight

Formatted: Font: Bold

Formatted: Font: Not Bold

Formatted: Font: Bold

Formatted: Font: Bold

Formatted: Font: Not Bold

~~DRSC.11.23.3 When the Demand Response Provider has submitted a final DRUD to the satisfaction of NGET which clearly demonstrates full compliance with the Ancillary Services agreement, NGET shall issue a Final Operational Notification to the Demand Response Provider.~~

~~DRSC.11.34 COMPLIANCE~~

~~DRSC.11.34.1 Responsibility of the Demand Response Provider~~

~~DRSC.11.4.1.1 Network Operators and Non-Embedded Customers are required to satisfy the requirements~~

Formatted: Not Highlight

~~in ECPX. (REMOVE)~~

DRSC.11.34.1.12 Demand Response Providers are required to satisfy the requirements of the Ancillary Services agreement which shall include satisfying the applicable requirements of this Demand Response Services Code.

Formatted: Font: Not Bold

DRSC.11.34.1.23 Should the Demand Response Provider wish to modify the technical capabilities of the ~~if its~~ Plant and Apparatus or Demand Unit(s) which it owns, operates, controls or manages and which affects its compliance with the Ancillary Services Agreement, it should notify and agree any timescales for the change with NGET prior to making any change to ~~their~~ Plant and Apparatus.

Formatted: Font: Not Bold

Formatted: Font: Not Bold

Formatted: Font: Not Bold

DRSC.11.34.1.34 Any operational incidents or failure of the Plant and Apparatus or Demand Unit(s) ~~owned, operated, controlled or managed by the Demand Response Provider's Plant and Apparatus~~ which impacts its ability to satisfy the compliance requirements detailed in this Demand Response Services Code shall be notified to NGET as soon as possible after occurrence of the incident.

Formatted: Font: Not Bold

Formatted: Font: Not Bold

Formatted: Font: Not Bold

Formatted: Font: Not Bold

Formatted: Font: Not Bold

Formatted: Font: Bold

DRSC.11.34.1.45 Any planned test schedules and procedures to verify compliance of the Plant and Apparatus or Demand Unit(s) owned, operated, controlled or managed by the Demand Response Provider's ~~Plant and Apparatus~~ shall be submitted to NGET in advance of the tests. NGET shall assess the test schedules and procedures in a timely manner prior to agreeing that the Demand Response Provider can carry out the tests.

Formatted: Font: Not Bold

Formatted: Font: Not Bold

DRSC.11.34.1.56 NGET may witness such tests and record the performance of the Plant and Apparatus owned, operated, controlled or managed by the Demand Response Providers ~~Plant and Apparatus~~ to verify compliance with the Ancillary Services agreement and the Demand Response Services Code.

DRSC.11.34.2 Role of NGET

DRSC.11.34.2.1 NGET shall assess the compliance of the Demand Response Provider and shall undertake monitoring throughout the life time of the ~~Demand Response Providers Plant and Apparatus~~ or Demand Unit(s) owned, operated, controlled or managed by the Demand Response Provider to ensure compliance with the requirements of the Ancillary Services agreement. ~~NGET shall inform the Demand Response Provider of the outcome of such assessment~~

Formatted: Font: Not Bold

Formatted: Font: Bold

Formatted: Font: Bold

Formatted: Font: Bold

DRSC.11.34.2.2 NGET may require Demand Response Providers to carry out compliance tests and simulations according to a repeat plan or general scheme or replacement of equipment which may have an impact on the compliance of the ~~Demand Response Providers Plant and Apparatus~~ or Demand Units owned, operated, controlled or managed by the Demand Response Provider as detailed in DRSC.11.34.1.3 and DRSC.11.34.1.4. NGET shall inform the Demand Response Provider of the results of these tests.

Formatted: Font: Not Bold

Formatted: Font: Not Bold

Formatted: Font: Bold

DRSC.11.34.2.3 As part of this compliance process, the Demand Response Provider shall provide the following items:-

- (a) ~~Relevant~~ documentation and certificates associated with the compliance process.

- (b) Details of the technical data required to ensure compliance with the **Ancillary Services** agreement.
- (c) Steady state and dynamic models (as applicable) of their **Demand Units or Plant and Apparatus** (or equivalent) as required and agreed with to the satisfaction of **NGET**.
- (d) Timelines for the submission of system data required to perform **System** studies
- (e) Study results showing the expected steady state and dynamic performance of their **Plant and Apparatus or Demand Unit(s) or the performance of their Demand Response Service on an aggregated basis as required and agreed with NGET**.
- (f) ~~Conditions and procedures including the scope for rSubmission of rregistereding Equipment Certificates~~ or otherwise as agreed with **NGET**.
- (g) Conditions and procedures for the use of relevant **Equipment Certificates** issued by an **Authorised Certifier** to a **Demand Response Provider** or equivalent to the satisfaction of **NGET**.

Formatted: Font: Bold
 Formatted: Font: Not Bold
 Formatted: Font: Not Bold
 Formatted: Font: Not Bold

Formatted: Font: Not Bold
 Formatted: Font: Not Bold
 Formatted: Font: Bold
 Formatted: Font: Bold

Formatted: Font: Not Bold

DRSC.11.34.2.4 If compliance tests or simulations cannot be carried out as agreed between the **Demand** ~~Response Provider~~ and **NGET** due to reasons attributable to **NGET**, then **NGET** shall not unreasonably withhold the **Operational Notification** referred to in DRSC.11.23.3.

Formatted: Font: Bold
 Formatted: Not Highlight
 Formatted: Not Highlight

DRSC.11.45 Compliance Testing

DRSC.11.45.1 Common Provisions for Compliance Testing

DRSC.11.45.1.1 The purpose of ~~c~~Compliance testing is to ensure that the **Demand Response Providers Plant and Apparatus or Demand Unit(s) owned, operated, controlled or managed by a Demand Response Provider** is capable of satisfying the requirements of the **Ancillary Services** agreement and applicable sections of this **Demand Response Services Code** in addition to verifying that the models and data submitted provide a true and accurate representation of the **Plant** as built.

Formatted: Font: Not Bold

DRSC.11.45.1.2 Notwithstanding the minimum requirements for compliance testing detailed in DRSC.11.45 of this **Demand Response Services Code**, **NGET** shall:-

Formatted: Not Highlight
 Formatted: Not Highlight

- (a) Allow the **Demand Response Provider** to carry out an alternative set of tests provided that they are efficient and sufficient to demonstrate that the **Plant and Apparatus or Demand Unit(s) Demand Response Providers owned, operated, controlled or managed by a Demand Response Provider** ~~Plant and Apparatus~~ is capable of satisfying the requirements of the **Ancillary Services** agreement and the applicable sections of the **Demand Response Services Code**.
- (b) Require the **Demand Response Provider** to carry out additional or alternative tests (where reasonable) to those specified in DRSC.11.56 where they would otherwise be insufficient to demonstrate compliance with the **Ancillary Services** agreement.

Formatted: Font: Bold
 Formatted: Font: Bold
 Formatted: Font: Bold

Formatted: Not Highlight
 Formatted: Not Highlight

(c) Require the **Demand Response Provider** to be responsible for carrying out the tests in accordance with the requirements specified in ~~DRSC.11.4 and DRSC.11.56~~ of the **Demand Response Services Code**. NGET shall cooperate with the **Demand Response Provider** and will not unduly delay the scheduling of the tests.

Formatted: Not Highlight

Formatted: Not Highlight

DRSC.11.45.1.3 NGET may witness such tests (either on site or remotely from NGET's control room) to record the performance of the **Demand Response Providers's capability Plant and Apparatus to capability** to verify compliance with the **Ancillary Services** agreement and the **Demand Response Services Code**. Where NGET witnesses the tests remotely, the **Demand Response Provider** shall provide the monitoring equipment necessary to record all relevant test signals and measurements in addition to ensuring that necessary representatives from the **Demand Response Provider** are available on site for the entire testing period. Signals specified by NGET shall be provided if for selected tests, NGET wishes to use its own equipment to record performance. NGET will inform the **Demand Response Provider** if it wishes to witness the tests.

Formatted: Font: Not Bold

Formatted: Font: Not Bold

Formatted: Font: Not Bold

DRSC.11.56 Compliance Testing for Demand Response Providers's with Demand Response Active Power Control, Reactive Power Control and Transmission Constraint Management.

DRSC.11.56.1 Demand Modification Tests

DRSC.11.56.1.1 **Demand Response Providers's** who have signed an **Ancillary Services** agreement with NGET to provide **Demand Response Active Power Control, Demand Response Reactive Power Control or Demand Response Transmission Constraint Management**, are required to demonstrate (through site tests) the capability of their **Plant and Apparatus or Demand Unit(s) they own, operate, control or manage** to satisfy the requirements of the **Ancillary Services** agreement and **the** applicable requirements of DRSC.5. The site tests should demonstrate the capability of the **Demand Response Providers's** ability to operate with instruction over the agreed timeframes, **Demand** range and duration pursuant to the terms of the **Ancillary Services** agreement. The tests can be completed individually or as part of a **Demand** aggregation scheme.

Formatted: Font: Not Bold

Formatted: Font: Not Bold

Formatted: Font: Not Bold

Formatted: Font: Bold

Formatted: Not Highlight

Formatted: Font: Not Bold

DRSC.11.56.1.2 The tests shall be carried out either by instruction from NGET's **Control Centre** or by site tests through injections applied to the ~~**Demand Response Providers Plant and Apparatus**~~ **or Demand Unit(s) owned, operated, controlled or managed by the Demand Response Provider.**

Formatted: Font: Not Bold

Formatted: Font: Not Bold

DRSC.11.56.1.3 The test shall be deemed as passed if the requirements of the **Ancillary Services** agreement have been satisfied and the applicable requirements of **DRSC.5** demonstrated to the satisfaction of **NGET**.

Formatted: Not Highlight

DRSC.11.56.1.4 A list of references to **Equipment Certificates** issued by an **Authorised Certifier** (or otherwise) ~~as agreed with NGET, which can be used for equipment that is installed at the site or copies of the relevant Equipment Certificates issued by an Authorised Certifier (or otherwise), can be~~ supplied by the **Demand Response Provider** to demonstrate part of the evidence of compliance;

Formatted: Font: Not Bold

DRSC.11.56.2 Disconnection and Reconnection of Static Compensation Facilities

DRSC.11.56.2.1 **Demand Response Providers's** who have signed an **Ancillary Services** agreement with

Formatted: Font: Not Bold

NGET to provide Demand Response Active Power Control, Demand Response Reactive Power Control or Demand Response Transmission Constraint Management and have also agreed to disconnect or reconnect (or both) ~~its~~ static compensation facilities when receiving an instruction from NGET in accordance with the requirements of the Ancillary Services agreement and DRSC.5.3, shall be required to demonstrate the performance of ~~the their Plant and Apparatus or Demand Unit(s) they own, operate, control or manage to~~in satisfying these requirements. These requirements can be demonstrated individually or collectively as part of a demand aggregation scheme.

Formatted: Not Highlight

Formatted: Font: Not Bold

DRSC.11.56.24.2 The tests shall be carried out either by instruction from NGET's Control Centre or by site tests resulting in the disconnection and subsequent re-connection of the static compensation facilities.

Formatted: Font: Not Bold

DRSC.11.56.24.3 The test shall be deemed as passed if the requirements of the Ancillary Services agreement have been satisfied and the applicable requirements of DRSC.5.3 demonstrated to the satisfaction of NGET.

DRSC.11.67 Compliance Simulation

DRSC.11.67.1 Common Provisions on Compliance Simulations

DRSC.11.67.1.1 Demand Response Providers ~~s~~ who agree to provide Demand Response Very Fast Active Power Control in accordance with the terms of the Ancillary Services agreement and DRSC.7 are required to demonstrate their ability to satisfy the requirements of the Ancillary Services agreement and DRSC.7 through necessary simulation studies to the satisfaction of NGET.

Formatted: Font: Not Bold

DRSC.11.67.1.2 Demand Response Providers ~~s who have contracted to provide-~~ a Demand Response Very Fast Active Power Control service, are required to submit further simulation studies ~~in respect of Demand Response Very Fast Active Power Control~~ where there has been a development, replacement or modernisation of the Demand Response Providers Plant and Apparatus ~~or Demand Unit(s) owned, operated, controlled or managed by the Demand Response Provider,~~ or NGET has identified a non-compliance with the Demand Response Provider's ability to satisfy the requirements of the Ancillary Services agreement ~~or and~~ DRSC.7.

Formatted: Font: Not Bold

Formatted: Font: Bold

Formatted: Font: Not Bold

Formatted: Not Highlight

DRSC.11.67.1.3 Notwithstanding the requirements of DRSC.11.67.1.1 and DRSC.11.67.1.2 NGET shall be entitled to:-

(a) Allow the Demand Response Provider to carry out an alternative set of ~~simulation tests~~ provided that they are efficient and sufficient to demonstrate that the Demand Response Providers Plant and Apparatus ~~or Demand Unit(s) owned, operated, controlled or managed by the Demand Response Provider~~ is capable of satisfying the requirements of the Ancillary Services agreement and the applicable sections of the Demand Response Services Code.

Formatted: Font: Bold

(b) Require the Demand Response Provider to carry out additional or alternative simulations to those specified in DRSC11.6.1.17 and DRSC.11.6.1.278 where they would otherwise be insufficient to demonstrate compliance with the Ancillary Services agreement.

Formatted: Not Highlight

Formatted: Not Highlight

Formatted: Not Highlight

Formatted: Not Highlight

DRSC.11.67.1.4 NGET may check that the **Demand Response Provider** complies with the requirements of the **Ancillary Services** agreement and the applicable sections of the **Demand Response Services Code** by carrying out its own compliance simulations based on the simulation reports, models and test measurements.

DRSC.11.67.1.5 NGET will supply upon request ~~from the Demand Response Provider~~, data to enable the **Demand Response Provider** to carry out the required simulations in accordance with the requirements of the **Ancillary Services** agreement and DRSC.11.67.

~~DRSC.11.78 Compliance Simulations for Demand Units with Demand Response Very Fast Active Power Control~~

~~DRSC.11.78.1 Demand Response Providers shall supply a model to NGET to demonstrate the technical capability of the Demand Response Providers Plant and Apparatus owned, operated, controlled or managed by the Demand Response Provider to provide Very Fast Active Power Control in accordance with the terms of the Ancillary Services agreement and DRSC.7. The Demand Response Provider can carry out an alternative set of simulations provided the simulations are efficient and suffice to demonstrate the Plant and Apparatus owned, operated, controlled or managed by a Demand Response Provider can satisfy the requirements of the Ancillary Services agreement and this DRSC.~~

~~DRSC.11.7.28 The simulation shall be deemed successful provided the Demand Response Providers Plant and Apparatus owned, operated, controlled or managed by the Demand Response Provider satisfies the requirements to the Ancillary Services agreement and DRSC.7 to the satisfaction of NGET. Where the simulations are insufficient to demonstrate compliance with the requirements of the Ancillary Services Agreement or this DRSC, NGET may require the Demand Response Provider to run additional or alternative simulations.~~

~~DRSC.9 GOVERNANCE OF BALANCING SERVICES PRINCIPLES IN ACCORDANCE WITH THE PROCUREMENT GUIDELINE TESTING GUIDANCE DOCUMENT~~

~~DRSC.9.1 The procurement guidelines have been developed in consultation with The Authority and in accordance with standard condition C16 of NGET's Transmission Licence. The guidelines may only be modified in accordance with the processes set out in standard condition C16 of NGET Electricity Transmission Licence. The procurement guidelines set out the kinds of Balancing Services which NGET may be interested in purchasing, together with the mechanisms by which such Balancing Services will be procured.~~

Formatted: Font: Bold

Formatted: Font: Bold

Formatted: Font: Bold

Formatted: Font: Not Bold

Formatted: Font: Bold

Formatted: Font: Bold

Formatted: Font: Bold

Formatted: Font: Bold

Formatted: Font: Bold

Formatted: Font: Bold

Formatted: Justified

Formatted: Font: Calibri, 11 pt

Formatted: Font: Calibri, 11 pt, Bold

Formatted: Font: Calibri, 11 pt

Formatted: Font: Calibri, 11 pt, Bold

Formatted: Font: Calibri, 11 pt

Formatted: Font: Calibri, 11 pt, Bold

Formatted: Font: Calibri, 11 pt

Formatted: Font: Calibri, 11 pt, Bold

Formatted: Font: Calibri, 11 pt

Formatted: Font: Calibri, 11 pt, Bold

Formatted: Font: Calibri, 11 pt

Formatted: Font: Calibri, 11 pt, Bold

Formatted: Font: Calibri, 11 pt

Formatted: Font: Calibri, 11 pt, Bold

Formatted: Font: Calibri, 11 pt

Formatted: Font: Calibri, 11 pt, Bold

Formatted: Font: Calibri, 11 pt

Formatted: Indent: Left: 0 cm, First line: 0 cm

APPENDIX I – DRSC.A.1
PART I
SUMMARY OF DEMAND RESPONSE SERVICES AND BALANCING SERVICES

<u>DEMAND RESPONSE SERVICE</u>	<u>BALANCING SERVICE</u>
<u>Demand Response Active Power Control</u>	<u>Firm Frequency Response (FFR) – Non dynamic</u> <u>Short Term Operating Reserve</u> <u>Demand Turn – Up</u> <u>Demand Side Response</u>
<u>Demand Response Reactive Power Control</u>	<u>Demand Side Response</u>
<u>Demand Response Transmission Constraint Management</u>	<u>Demand Side Response</u>

Formatted: Indent: Left: 0 cm, First line: 0 cm

Formatted: Not Highlight

Formatted: Not Highlight

Formatted: Not Highlight

Formatted: Not Highlight

Formatted: Not Highlight

Formatted: Not Highlight

Demand Response System Frequency Control	Firm Frequency Response (FFR) – dynamic Enhanced Frequency Response (EFR)
Demand Response Very Fast Active Power Control	Fast Reserve Enhanced Frequency Response (EFR)

- Formatted: Not Highlight
- Formatted: Highlight
- Formatted: Not Highlight
- Formatted: Not Highlight

~~APPENDIX I – DRSC.A.1~~

~~PART II~~

~~BALANCING SERVICES REQUIREMENTS~~

~~Demand Response Providers can offer one or more Balancing Services to NGET. The following information has been provided on NGET’s website to provide Demand Response Providers with more details of each Balancing Service and the necessary requirements should they wish to offer them as an Ancillary Service to NGET. Such requirements would be pursuant to the Standard Contract Terms.~~

~~Firm Frequency Response – Non-Dynamic and Dynamic~~

~~<https://www.nationalgrid.com/uk/electricity/balancing-services/frequency-response-services/firm-frequency-response>~~

~~Short Term Operating Reserve~~

- Formatted: Not Highlight
- Formatted: Font: Bold
- Formatted: Centered
- Formatted: Font: Bold
- Formatted: Highlight
- Formatted: Font: Bold
- Formatted: Justified, Indent: Left: 0 cm, First line: 0 cm, Tab stops: 0 cm, Left + Not at 2.29 cm
- Formatted: Font: Bold
- Formatted: Font: Bold
- Formatted: Font: Bold
- Formatted: Font: Bold
- Formatted: Font: Bold
- Formatted: Font: Bold
- Formatted: Font: Bold
- Formatted: Font: Bold
- Formatted: Highlight
- Formatted: Underline
- Formatted: Font: Italic

https://www.nationalgrid.com/uk/electricity/balancing_services/reserve_services/short_term_operating_reserve_stor

Demand Turn Up

https://www.nationalgrid.com/uk/electricity/balancing_services/reserve_services/demand_turn

Demand Side Response

https://www.nationalgrid.com/uk/electricity/balancing_services/demand_side_response_dsr

Enhanced Frequency Response

https://www.nationalgrid.com/uk/electricity/balancing_services/frequency_response_services/enhanced_frequency_response_eff

Fast Reserve

https://www.nationalgrid.com/uk/electricity/balancing_services/reserve_services/fast_reserve

Formatted: Indent: Left: 0 cm, First line: 0 cm, Tab stops: 0 cm, Left + Not at 2.29 cm

Formatted: Indent: Left: 0 cm, First line: 0 cm, Tab stops: 0 cm, Left + Not at 2.29 cm

Formatted: Font: Italic

Formatted: Underline

Formatted: Indent: Left: 0 cm, First line: 0 cm, Tab stops: 0 cm, Left + Not at 2.29 cm

Formatted: Indent: Left: 0 cm, First line: 0 cm, Tab stops: 0 cm, Left + Not at 2.29 cm

Formatted: Underline

Formatted: Indent: Left: 0 cm, First line: 0 cm, Tab stops: 0 cm, Left + Not at 2.29 cm

Formatted: No bullets or numbering

APPENDIX II – DRSC.A.12

Format of the Demand Response Unit Document (DRUD)

Demand Response Unit Document (DRUD)

Statement of Compliance for Demand Response Providers

Formatted: Font: Calibri

Formatted: Font: Calibri

Contract company details

<u>Contracted company name</u>	
<u>Primary contact name</u>	
<u>Contact number /s</u>	
<u>Email address</u>	

Formatted: Font: Calibri, 11 pt

Demand Response Service Details

<u>Contract ID</u>	
<u>Type of Demand Response Service type,</u>	
<u>Asset type,</u>	

Formatted: Font: Calibri, 11 pt

Formatted: Font: Bold

<u>Unit make up</u>	
<u>Aggregation methodology (if appropriate)</u>	
<u>Maximum capacity of the Demand Response Service (MW)</u>	
<u>Equipment Certificates (as applicable)</u>	
<u>Unit location/ connection point / ID</u>	
<u>Contract signed date</u>	
<u>Service start date</u>	
<u>Desired test date</u>	

Formatted: Font: Bold

Formatted: Font: Bold

Formatted: Font: Calibri, 11 pt

Compliance Requirements

<u>DRSC Requirement</u>	<u>Compliance Y/N</u>	<u>Demand Response Provider Statement</u>
<u>All documentation and certificates demonstrating compliance with the DRSC.</u>		
<u>Details of the technical data required to ensure compliance with the Ancillary Services agreement.</u>		
<u>Steady state and dynamic models (or equivalent information) of Plant and Apparatus or Demand Unit(s).</u>		
<u>Timelines for the submission of system studies or equivalent data.</u>		
<u>Study results showing the expected steady state and dynamic performance of the Plant and Apparatus or Demand Unit(s)</u>		
<u>Conditions and procedures including the scope for registering Equipment Certificates or otherwise as agreed with NGET.</u>		
<u>Conditions and procedures for the use of relevant Equipment Certificates issued by an Authorised Certifier to a Demand Response Provider.</u>		
<u>Operational Metering Data to be submitted in accordance with Ancillary Services agreement.</u>		
<u>Ability to receive instructions to and from NGET accordance with the Ancillary Services agreement.</u>		
<u>Ability to operate over frequency range as specified in DRSC.5.1(a).</u>		
<u>Ability to operate over voltage range as specified in DRSC.5.1(b).</u>		
<u>Ability to withstand a rate of change of system frequency up to a maximum of 1Hz per second as measured over a 500ms timeframe as specified in</u>		

Formatted: Font: Bold

Formatted: Font: Bold

Formatted: Font: Bold

Formatted: Font: Bold

Formatted: Font: Not Bold

Formatted: Font: Bold

Formatted: Font: Bold

Formatted: Font: Not Bold

Formatted: Font: Bold

Formatted: Font: Bold

Formatted: Font: Bold

Formatted: Font: Bold

Formatted: Font: Bold

Formatted: Font: Bold

Formatted: Font: Bold

Formatted: Font: Bold

Formatted: Font: Bold

<u>DRSC Requirement</u>	<u>Compliance Y/N</u>	<u>Demand Response Provider Statement</u>
<u>DRSC.5.1(i).</u>		
<u>Non-Embedded Customers who are also Demand Response Providers's ability to switch static compensation equipment into or out of service in accordance with DRSC5.3 as applicable.</u>		
<u>Deadband settings as applicable.</u>		
<u>Control sSystem bBlock diagrams, parameters and settings as applicable.</u>		

Formatted: Font: Bold

Formatted: Font: Bold

Formatted: Font: Calibri, 11 pt

Declaration

Declaration – to be completed by Customer or the Demand Response Provider's appointed technical representative

I declare that for all the Demand Response Provider's information associated with this contract:

1. Compliance with the requirements of the Demand Response Services Code is achieved.
2. The commissioning checks have been successfully completed.

Name:

Signature:

Company Name:

Position:

Declaration – to be completed by NGET Witnessing Representative if applicable. Delete if not witnessed by the NGET.

I confirm that I have witnessed the commissioning checks in this document on behalf of

_____ and that the results are an accurate record of the checks

Name:

Signature:

Company Name:

Formatted: Font: Not Bold

Formatted: Font: Not Bold

< END OF DEMAND RESPONSE SERVICES CODE >

Formatted: Left

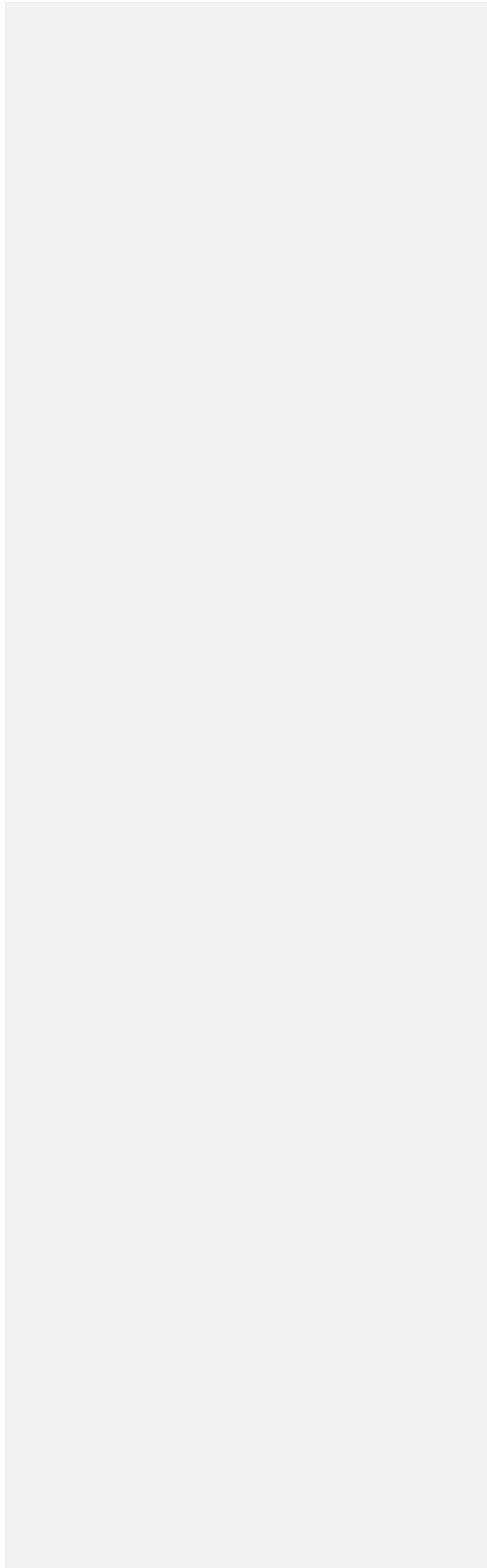

GC0104
DATA REGISTRATION CODE LEGAL TEXT
DATED 31/01/2018

- 1) Blue Highlighted Text – Taken from GC0102 Code Administrator Consultation dated 12/01/2018 - Not relevant for DCC
- 2) Black – Relevant text for GC0104
- 3) [Track change marked text – relevant changes for GC0104](#)

**DATA REGISTRATION CODE
(DRC)**

CONTENTS

(This contents page does not form part of the Grid Code)

Paragraph No/Title	Page Number
DRC.1 INTRODUCTION	4
DRC.2 OBJECTIVE	54
DRC.3 SCOPE.....	54
DRC.4 DATA CATEGORIES AND STAGES IN REGISTRATION.....	54
DRC.4.2 Standard Planning Data	65
DRC.4.3 Detailed Planning Data	65
DRC.4.4 Operational Data	65
DRC.5 PROCEDURES AND RESPONSIBILITIES	65
DRC.5.1 Responsibility For Submission And Updating Of Data	65
DRC.5.2 Methods Of Submitting Data	65
DRC.5.3 Changes To Users Data	76
DRC.5.4 Data Not Supplied	76
DRC.5.5 Substituted Data	76
DRC.6 DATA TO BE REGISTERED	76
SCHEDULE 1 - GENERATING UNIT (OR CCGT MODULE), POWER PARK MODULE AND DC CONVERTER TECHNICAL DATA	1140
SCHEDULE 2 - GENERATION PLANNING PARAMETERS	3837
SCHEDULE 3 - LARGE POWER STATION OUTAGE PROGRAMMES, OUTPUT USABLE AND INFLEXIBILITY INFORMATION	4241
SCHEDULE 4 - LARGE POWER STATION DROOP AND RESPONSE DATA	4544
SCHEDULE 5 - USERS SYSTEM DATA	4645
SCHEDULE 6 - USERS OUTAGE INFORMATION	5756
SCHEDULE 7 - LOAD CHARACTERISTICS AT GRID SUPPLY POINTS	6059
SCHEDULE 8 - DATA SUPPLIED BY BM PARTICIPANTS	6160
SCHEDULE 9 - DATA SUPPLIED BY NGET TO USERS.....	6261
SCHEDULE 10 - DEMAND PROFILES AND ACTIVE ENERGY DATA	6362
SCHEDULE 11 - CONNECTION POINT DATA	6564
SCHEDULE 12 - DEMAND CONTROL.....	7069
SCHEDULE 13 - FAULT INFEEED DATA	7372
SCHEDULE 13 - FAULT INFEEED DATA	7473
SCHEDULE 14 - FAULT INFEEED DATA (GENERATORS INCLUDING UNIT TRANSFORMERS AND STATION TRANSFORMERS)	7574
SCHEDULE 15 - MOTHBALLED GENERATING UNIT, MOTHBALLED POWER PARK MODULE MOTHBALLED DC CONVERTERS AT A DC CONVERTER STATION AND ALTERNATIVE FUEL DATA	8079

SCHEDULE 16 - BLACK START INFORMATION	84
SCHEDULE 17 - ACCESS PERIOD DATA	85
SCHEDULE 18 - OFFSHORE TRANSMISSION SYSTEM DATA	86
SCHEDULE 19 - USER DATA FILE STRUCTURE	110
DRC.1 - INTRODUCTION	4
DRC.2 - OBJECTIVE	4
DRC.3 - SCOPE	4
DRC.4 - DATA CATEGORIES AND STAGES IN REGISTRATION	4
DRC.4.2 - Standard Planning Data	5
DRC.4.3 - Detailed Planning Data	5
DRC.4.4 - Operational Data	5
DRC.5 - PROCEDURES AND RESPONSIBILITIES	5
DRC.5.1 - Responsibility For Submission And Updating Of Data	5
DRC.5.2 - Methods Of Submitting Data	5
DRC.5.3 - Changes To Users Data	6
DRC.5.4 - Data Not Supplied	6
DRC.5.5 - Substituted Data	6
DRC.6 - DATA TO BE REGISTERED	6
SCHEDULE 1 - GENERATING UNIT (OR CCGT MODULE), POWER PARK MODULE AND DC CONVERTER TECHNICAL DATA	1
SCHEDULE 2 - GENERATION PLANNING PARAMETERS	18
SCHEDULE 3 - LARGE POWER STATION OUTAGE PROGRAMMES, OUTPUT USABLE AND INFLEXIBILITY INFORMATION	2
SCHEDULE 4 - LARGE POWER STATION DROOP AND RESPONSE DATA	15
SCHEDULE 5 - USERS SYSTEM DATA	16
SCHEDULE 6 - USERS OUTAGE INFORMATION	16
SCHEDULE 7 - LOAD CHARACTERISTICS AT GRID SUPPLY POINTS	10
SCHEDULE 8 - DATA SUPPLIED BY BM PARTICIPANTS	14
SCHEDULE 9 - DATA SUPPLIED BY NGET TO USERS	12
SCHEDULE 10 - DEMAND PROFILES AND ACTIVE ENERGY DATA	13
SCHEDULE 11 - CONNECTION POINT DATA	15
SCHEDULE 12 - DEMAND CONTROL	10
SCHEDULE 13 - FAULT INFEEED DATA	13
SCHEDULE 13 - FAULT INFEEED DATA	14
SCHEDULE 14 - FAULT INFEEED DATA (GENERATORS INCLUDING UNIT TRANSFORMERS AND STATION TRANSFORMERS)	15
SCHEDULE 15 - MOTHBALLED GENERATING UNIT, MOTHBALLED POWER PARK MODULE, MOTHBALLED DC CONVERTERS AT A DC CONVERTER STATION AND ALTERNATIVE FUEL DATA)	11
SCHEDULE 16 - BLACK START INFORMATION	16
SCHEDULE 17 - ACCESS PERIOD DATA	17
SCHEDULE 18 - OFFSHORE TRANSMISSION SYSTEM DATA	18

- DRC.1.1 The **Data Registration Code ("DRC")** presents a unified listing of all data required by **NGET** from **Users** and by **Users** from **NGET**, from time to time under the **Grid Code**. The data which is specified in each section of the **Grid Code** is collated here in the **DRC**. Where there is any inconsistency in the data requirements under any particular section of the **Grid Code** and the **Data Registration Code** the provisions of the particular section of the **Grid Code** shall prevail.
- DRC.1.2 The **DRC** identifies the section of the **Grid Code** under which each item of data is required .
- DRC.1.3 The Code under which any item of data is required specifies procedures and timings for the supply of that data, for routine updating and for recording temporary or permanent changes to that data. All timetables for the provision of data are repeated in the **DRC**.
- DRC.1.4 Various sections of the **Grid Code** also specify information which **Users** will receive from **NGET**. This information is summarised in a single schedule in the **DRC** (Schedule 9).
- DRC.1.5 The categorisation of data into **DPD I** and **DPD II** is indicated in the **DRC** below.
- DRC.2 OBJECTIVE
- The objective of the **DRC** is to:
- DRC.2.1 List and collate all the data to be provided by each category of **User** to **NGET** under the **Grid Code**.
- DRC.2.2 List all the data to be provided by **NGET** to each category of **User** under the **Grid Code**.
- DRC.3 SCOPE
- DRC.3.1 The **DRC** applies to **NGET** and to **Users**, which in this **DRC** means:-
- (a) **Generators** (including those undertaking **OTSDUW** and/or those who own and/or operate **DC Connected Power Park Modules**);
 - (b) **Network Operators**;
 - (c) **DC Converter Station owners and HVDC System Owners**;
 - (d) **Suppliers**;
 - (e) **Non-Embedded Customers** (including, for the avoidance of doubt, a **Pumped Storage Generator** in that capacity);
 - (f) **Externally Interconnected System Operators**;
 - (g) **Interconnector Users**; and
 - (h) **BM Participants**.
- DRC.3.2 For the avoidance of doubt, the **DRC** applies to both **GC Code Users** and **EU Code Users** **User's**.
- DRC.4 DATA CATEGORIES AND STAGES IN REGISTRATION
- DRC.4.1.1 Within the **DRC** each data item is allocated to one of the following three categories:
- (a) **Standard Planning Data (SPD)**
 - (b) **Detailed Planning Data (DPD)**
 - (c) **Operational Data**

- DRC.4.2 Standard Planning Data (SPD)
- DRC.4.2.1 The **Standard Planning Data** listed and collated in this **DRC** is that data listed in Part 1 of the Appendix to the **PC**.
- DRC.4.2.2 **Standard Planning Data** will be provided to **NGET** in accordance with PC.4.4 and PC.A.1.2.
- DRC.4.3 Detailed Planning Data (DPD)
- DRC.4.3.1 The **Detailed Planning Data** listed and collated in this **DRC** is categorised as **DPD I** and **DPD II** and is that data listed in Part 2 of the Appendix to the **PC**.
- DRC.4.3.2 **Detailed Planning Data** will be provided to **NGET** in accordance with PC.4.4, PC.4.5 and PC.A.1.2.
- DRC.4.4 Operational Data
- DRC.4.4.1 **Operational Data** is data which is required by the **Operating Codes** and the **Balancing Codes**. Within the **DRC**, **Operational Data** is sub-categorised according to the Code under which it is required, namely **OC1**, **OC2**, **BC1** or **BC2**.
- DRC.4.4.2 **Operational Data** is to be supplied in accordance with timetables set down in the relevant **Operating Codes** and **Balancing Codes** and repeated in tabular form in the schedules to the **DRC**.
- DRC.5 PROCEDURES AND RESPONSIBILITIES
- DRC.5.1 Responsibility For Submission And Updating Of Data
- In accordance with the provisions of the various sections of the **Grid Code**, each **User** must submit data as summarised in DRC.6 and listed and collated in the attached schedules.
- DRC.5.2 Methods Of Submitting Data
- DRC.5.2.1 Wherever possible the data schedules to the **DRC** are structured to serve as standard formats for data submission and such format must be used for the written submission of data to **NGET**.
- DRC.5.2.2 Data must be submitted to the **Transmission Control Centre** notified by **NGET** or to such other department or address as **NGET** may from time to time advise. The name of the person at the **User Site** who is submitting each schedule of data must be included.
- DRC.5.2.3 Where a computer data link exists between a **User** and **NGET**, data may be submitted via this link. **NGET** will, in this situation, provide computer files for completion by the **User** containing all the data in the corresponding **DRC** schedule.
- Data submitted can be in an electronic format using a proforma to be supplied by **NGET** or other format to be agreed annually in advance with **NGET**. In all cases the data must be complete and relate to, and relate only to, what is required by the relevant section of the **Grid Code**.
- DRC.5.2.4 Other modes of data transfer, such as magnetic tape, may be utilised if **NGET** gives its prior **written consent**.
- DRC.5.2.5 **Generators, HVDC System Owners and DC Converter Station** owners submitting data for a **Power Generating Module, Generating Unit, DC Converter, HVDC System, Power Park Module** (including **DC Connected Power Park Modules**) or **CCGT Module** before the issue of a **Final Operational Notification** should submit the **DRC data schedules and compliance information** required under the **CP** electronically using the **User Data File Structure** unless otherwise agreed with **NGET**.

- DRC.5.3 Changes To Users' Data
- DRC.5.3.1 Whenever a **User** becomes aware of a change to an item of data which is registered with **NGET** the **User** must notify **NGET** in accordance with each section of the Grid Code. The method and timing of the notification to **NGET** is set out in each section of the Grid Code.
- DRC.5.4 Data Not Supplied
- DRC.5.4.1 **Users** and **NGET** are obliged to supply data as set out in the individual sections of the **Grid Code** and repeated in the **DRC**. If a **User** fails to supply data when required by any section of the **Grid Code**, **NGET** will estimate such data if and when, in the **NGET's** view, it is necessary to do so. If **NGET** fails to supply data when required by any section of the **Grid Code**, the **User** to whom that data ought to have been supplied, will estimate such data if and when, in that **User's** view, it is necessary to do so. Such estimates will, in each case, be based upon data supplied previously for the same **Plant** or **Apparatus** or upon corresponding data for similar **Plant** or **Apparatus** or upon such other information as **NGET** or that **User**, as the case may be, deems appropriate.
- DRC.5.4.2 **NGET** will advise a **User** in writing of any estimated data it intends to use pursuant to DRC.5.4.1 relating directly to that **User's Plant** or **Apparatus** in the event of data not being supplied.
- DRC.5.4.3 A **User** will advise **NGET** in writing of any estimated data it intends to use pursuant to DRC.5.4.1 in the event of data not being supplied.
- DRC.5.5 Substituted Data
- DRC.5.5.1 In the case of PC.A.4 only, if the data supplied by a **User** does not in **NGET's** reasonable opinion reflect the equivalent data recorded by **NGET**, **NGET** may estimate such data if and when, in the view of **NGET**, it is necessary to do so. Such estimates will, in each case, be based upon data supplied previously for the same **Plant** or **Apparatus** or upon corresponding data for similar **Plant** or **Apparatus** or upon such other information as **NGET** deems appropriate.
- DRC.5.5.2 **NGET** will advise a **User** in writing of any estimated data it intends to use pursuant to DRC.5.5.1 relating directly to that **User's Plant** or **Apparatus** where it does not in **NGET's** reasonable opinion reflect the equivalent data recorded by **NGET**. Such estimated data will be used by **NGET** in place of the appropriate data submitted by the **User** pursuant to PC.A.4 and as such shall be deemed to accurately represent the **User's** submission until such time as the **User** provides data to **NGET's** reasonable satisfaction.
- DRC.6 DATA TO BE REGISTERED
- DRC.6.1 Schedules 1 to 19 attached cover the following data areas.
- DRC.6.1.1 Schedule 1 – Power Generating Module, Generating Unit (or CCGT Module), Power Park Module (including DC Connected Power Park Module and Power Park Unit), HVDC System and DC Converter Technical Data.
Comprising **Power Generating Module, Generating Unit (and CCGT Module), Power Park Module (including DC Connected Power Park Module and Power Park Unit) and DC Converter** fixed electrical parameters.
- DRC.6.1.2 Schedule 2 - Generation Planning Parameters
Comprising the **Genset** parameters required for **Operational Planning** studies.
- DRC.6.1.3 Schedule 3 - Large Power Station Outage Programmes, Output Usable And Inflexibility Information.
Comprising generation outage planning, **Output Usable** and inflexibility information at timescales down to the daily **BM Unit Data** submission.

- DRC.6.1.4** Schedule 4 - Large Power Station Droop And Response Data.
Comprising data on governor **Droop** settings and **Primary, Secondary and High Frequency Response** data for **Large Power Stations**.
- DRC.6.1.5 Schedule 5 – User's System Data.
Comprising electrical parameters relating to **Plant** and **Apparatus** connected to the **National Electricity Transmission System**.
- DRC.6.1.6 Schedule 6 – Users Outage Information.
Comprising the information required by **NGET** for outages on the **User System**, including outages at **Power Stations** other than outages of **Gensets**
- DRC.6.1.7 Schedule 7 - Load Characteristics.
Comprising the estimated parameters of load groups in respect of, for example, harmonic content and response to frequency.
- DRC.6.1.8 Schedule 8 - BM Unit Data.
- DRC.6.1.9 Schedule 9 - Data Supplied By NGET To Users.
- DRC.6.1.10 Schedule 10 - Demand Profiles And Active Energy Data
Comprising information relating to the **Network Operators'** and **Non-Embedded Customers'** total **Demand** and **Active Energy** taken from the **National Electricity Transmission System**
- DRC.6.1.11 Schedule 11 - Connection Point Data
Comprising information relating to **Demand**, demand transfer capability and the **Small Power Station, Medium Power Station** and **Customer** generation connected to the **Connection Point**
- DRC.6.1.12 Schedule 12 - Demand Control Data
Comprising information related to **Demand Control**
- DRC.6.1.13 Schedule 13 - Fault Infeed Data
Comprising information relating to the short circuit contribution to the **National Electricity Transmission System** from **Users** other than **Generators, HVDC System Owners** and **DC Converter Station** owners.
- DRC.6.1.14** Schedule 14 - Fault Infeed Data (Generators Including Unit And Station Transformers)
Comprising information relating to the Short Circuit contribution to the **National Electricity Transmission System** from **Generators, HVDC System Owners** and **DC Converter Station** owners.
- DRC.6.1.15** Schedule 15 – Mothballed Power Generating Module, Mothballed Generating Unit, Mothballed Power Park Module (including Mothballed DC Connected Power Park Modules), Mothballed HVDC Systems, Mothballed HVDC Converters, Mothballed DC Converters at a DC Converter Station and Alternative Fuel Data
Comprising information relating to estimated return to service times for **Mothballed Power Generating Modules, Mothballed Generating Units, Mothballed Power Park Modules (including Mothballed DC Connected Power Park Modules), Mothballed HVDC Systems, Mothballed HVDC Converters** and **Mothballed DC Converters** at a **DC Converter Station** and the capability of gas-fired **Generating Units** to operate using alternative fuels.
- DRC.6.1.16 Schedule 16 – Black Start Information
Comprising information relating to **Black Start**.
- DRC.6.1.17 Schedule 17 – Access Period Schedule
Comprising **Access Period** information for **Transmission Interface Circuits** within an **Access Group**.

DRC.6.1.18 **Schedule 18 – Generators Undertaking OTSDUW Arrangements**

Comprising electrical parameters relating to **OTSDUW Plant and Apparatus between the Offshore Grid Entry Point and Transmission Interface Point.**

DRC.6.1.19 **Schedule 19 – User Data File Structure**

Comprising information relating to the **User Data File Structure.**

DRC.6.2 The **Schedules** applicable to each class of **User** are as follows:

User	Schedule
Generators with Large Power Stations	1, 2, 3, 4, 9, 14, 15, 16, 19
Generators with Medium Power Stations (see notes 2, 3, 4)	1, 2 (part), 9, 14, 15, 19
Generators with Small Power Stations directly connected to the National Electricity Transmission System	1, 6, 14, 15, 19
Generators undertaking OTSDUW (see note 5)	18, 19
All Users connected directly to the National Electricity Transmission System	5, 6, 9
All Users connected directly to the National Electricity Transmission System other than Generators	10,11,13,17
All Users connected directly to the National Electricity Transmission System with Demand	7, 9
A Pumped Storage Generator, Externally Interconnected System Operator and Interconnector Users	12 (as marked)
All Suppliers	12
All Network Operators	12
All BM Participants	8
All DC Converter Station owners	1, 4, 9, 14, 15, 19

Notes:

- (1) **Network Operators** must provide data relating to **Small Power Stations** and/or **Customer Generating Plant Embedded in their Systems** when such data is requested by **NGET** pursuant to PC.A.3.1.4 or PC.A.5.1.4.
- (2) The data in schedules 1, 14 and 15 need not be supplied in relation to **Medium Power Stations** connected at a voltage level below the voltage level of the **Subtransmission System** except in connection with a **CUSC Contract** or unless specifically requested by **NGET**.
- (3) Each **Network Operator** within whose **System** an **Embedded Medium Power Station** not subject to a **Bilateral Agreement** or **Embedded DC Converter Station** not subject to a **Bilateral Agreement** is situated shall provide the data to **NGET** in respect of each such **Embedded Medium Power Station** or **Embedded DC Converter Station** or **HVDC System**.

- (4) In the case of Schedule 2, **Generators, HVDC System Owners, DC Converter Station owners or Network Operators** in the case of **Embedded Medium Power Stations** not subject to a **Bilateral Agreement** or **Embedded DC Converter Stations** not subject to a **Bilateral Agreement**, would only be expected to submit data in relation to **Standard Planning Data** as required by the **Planning Code**.
- (5) In the case of **Generators** undertaking **OTSDUW**, the **Generator** will need to supply **User** data in accordance with the requirements of **Large** or **Small Power Stations** (as defined in DRC.6.2) up to the **Offshore Grid Entry Point**. In addition, the **User** will also need to submit **Offshore Transmission System** data in between the **Interface Point** and its **Connection Points** in accordance with the requirements of Schedule 18.

SCHEDULE 1 – POWER GENERATING MODULE, GENERATING UNIT (OR CCGT MODULE), POWER PARK MODULE, DC CONNECTED POWER PARK MODULE, HVDC SYSTEM AND DC CONVERTER TECHNICAL DATA

PAGE 1 OF 19

ABBREVIATIONS:

SPD = Standard Planning Data

% on MVA = % on Rated MVA

% on 100 = % on 100 MVA

DPD = Detailed Planning Data

RC = Registered Capacity

MC = Maximum Capacity

**OC1, BC1, etc = Grid Code
for which data is required**

CUSC Contract = User data which may be submitted to the Relevant Transmission Licensees by NGET, following the acceptance by a User of a CUSC Contract.

CUSC App. Form = User data which may be submitted to the Relevant Transmission Licensees by NGET, following an application by a User for a CUSC Contract.

Note:

All parameters, where applicable, are to be measured at nominal **System Frequency**

+ these **SPD** items should only be given in the data supplied with the application for a **CUSC Contract**.

* Asterisk items are not required for **Small Power Stations** and **Medium Power Stations**

Information is to be given on a **Unit** basis, unless otherwise stated. Where references to **CCGT Modules** are made, the columns "G1" etc should be amended to read "M1" etc, as appropriate

□ These data items may be submitted to the **Relevant Transmission Licensees** from **NGET** in respect of the **National Electricity Transmission System**. The data may be submitted to the **Relevant Transmission Licensees** in a summarised form e.g. network model; the data transferred will have been originally derived from data submitted by **Users** to **NGET**.

■ these data items may be submitted to the **Relevant Transmission Licensee** from **NGET** in respect to **Relevant Units** only. The data may be submitted to the **Relevant Transmission Licensee** in a summarised form e.g. network model; the data transferred will have been originally derived from data submitted by **Users** to **NGET**.

SCHEDULE 1 – POWER GENERATING MODULE, GENERATING UNIT (OR CCGT MODULE), POWER PARK MODULE, DC CONNECTED POWER PARK MODULE, HVDC SYSTEM AND DC CONVERTER TECHNICAL DATA

POWER STATION NAME: _____ DATE: _____

DATA DESCRIPTION	UNITS	DATA to		DATA CAT.	GENERATING UNIT OR STATION DATA						
		RTL CUSC Cont fact	CUSC App. Form		F.Yr.	F.Yr.	F.Yr.	F.Yr.	F.Yr.	F.Yr.	F.Yr.
					0	1	2	3	4	5	6
GENERATING STATION DEMANDS:											
Demand associated with the Power Station supplied through the National Electricity Transmission System or the Generator's User System (PC.A.5.2)											
- The maximum Demand that could occur.	MW MVA _r	■		DPD I DPD I							
- Demand at specified time of annual peak half hour of National Electricity Transmission System Demand at Annual ACS Conditions .	MW MVA _r	■		DPD II DPD II							
- Demand at specified time of annual minimum half-hour of National Electricity Transmission System Demand .	MW MVA _r	■		DPD II DPD II							
(Additional Demand supplied through the unit transformers to be provided below)											
INDIVIDUAL GENERATING UNIT (OR AS THE CASE MAY BE, SYNCHRONOUS POWER GENERATING MODULE OR CCGT MODULE) DATA					G1	G2	G3	G4	G5	G6	STN
Point of connection to the National Electricity Transmission System (or the Total System if embedded) of the Generating Unit or Synchronous Power Generating Module (other than a CCGT Unit) or the CCGT Module , as the case may be in terms of geographical and electrical location and system voltage (PC.A.3.4.1)	Text	■	■	SPD							
If the busbars at the Connection Point are normally run in separate sections identify the section to which the Generating Unit (other than a CCGT Unit) or Synchronous Power Generating Module or CCGT Module , as the case may be is connected (PC.A.3.1.5)	Section Number	■	■	SPD							

Type of Unit (steam, Gas Turbine
Combined Cycle Gas Turbine Unit,
tidal, wind, etc.)
(P.C.A.3.2.2 (h))

□

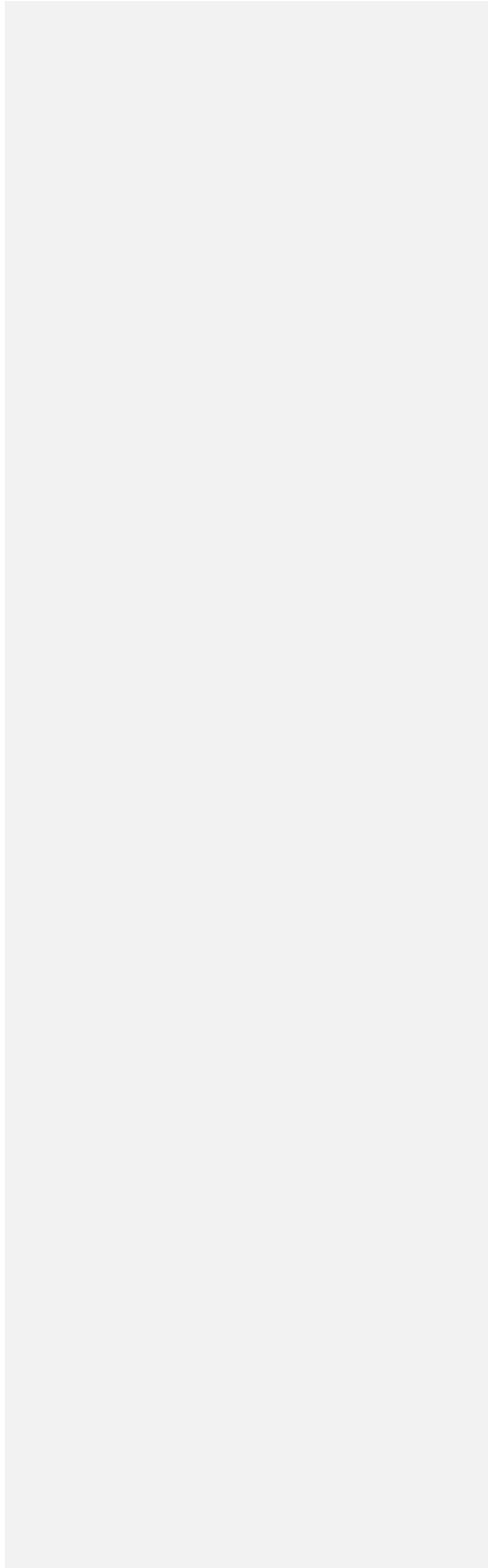

SCHEDULE 1 – POWER GENERATING MODULE, GENERATING UNIT (OR CCGT MODULE), POWER PARK MODULE, DC CONNECTED POWER PARK MODULE, HVDC SYSTEM AND DC CONVERTER TECHNICAL DATA

PAGE 3 OF 19

INDIVIDUAL SYNCHRONOUS POWER GENERATING MODULE GENERATING UNIT (OR AS THE CASE MAY BE, CCGT MODULE) DATA				G1	G2	G3	G4	G5	G6	STN
<p>A list of the Generating Units and CCGT Units within a Synchronous Power Generating Module or CCGT Module, identifying each CCGT Unit, and the Power Generating Module or CCGT Module of which it forms part, unambiguously. In the case of a Range CCGT Module, details of the possible configurations should also be submitted. (PC.A.3.2.2 (g))</p>	■	■	SPD							

!

Armature winding direct current resistance. (PC.A.5.3.2(a))	% on MVA	□	DPD I											
In Scotland, negative sequence resistance (PC.A.2.5.6 (a) (iv))	% on MVA	□	DPD I											

Note:- the above data item relating to armature winding direct-current resistance need only be provided by **Generators** in relation to **Generating Units or Synchronous Generating Units within Power Generating Modules** commissioned after 1st March 1996 and in cases where, for whatever reason, the **Generator** is aware of the value of the data item.

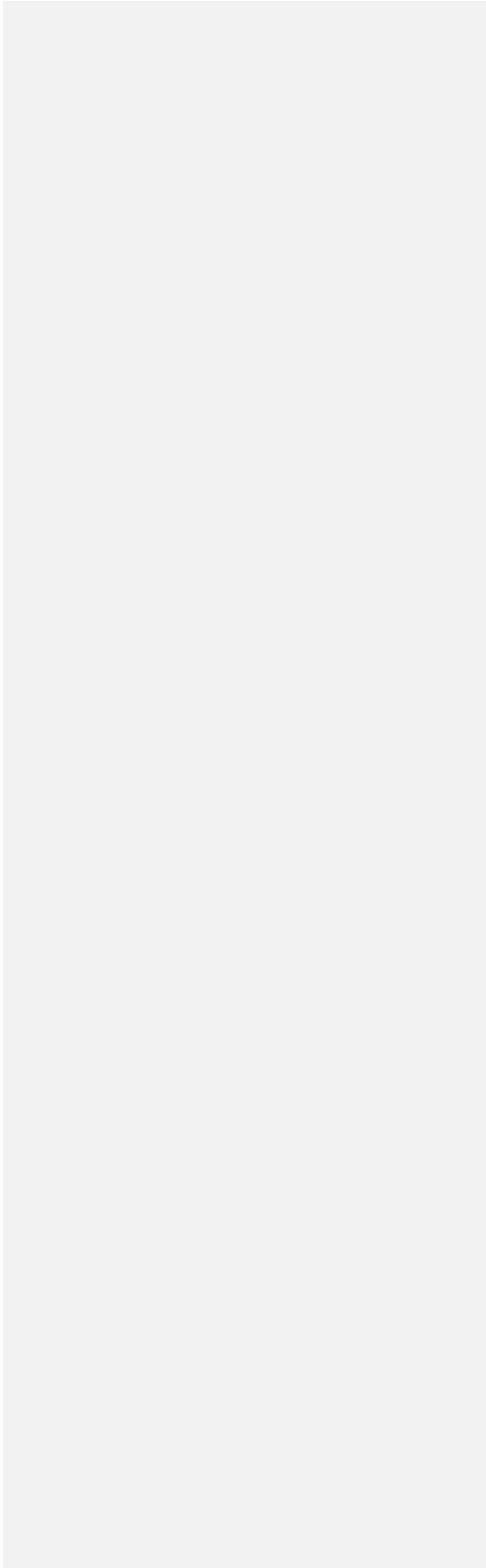

SCHEDULE 1 – POWER GENERATING MODULE, GENERATING UNIT (OR CCGT MODULE), POWER PARK MODULE DC CONNECTED POWER PARK MODULE, HVDC SYSTEM AND DC CONVERTER TECHNICAL DATA

DATA DESCRIPTION	UNITS	DATA to		DATA CAT.	GENERATING UNIT OR STATION DATA						
		CUSC Contract	RTL		CUSC App. Form	G1	G2	G3	G4	G5	G6
TIME CONSTANTS											
(Short-circuit and Unsaturated)											
Direct axis transient time constant <i>(PC.A.5.3.2(a))</i>	S	<input type="checkbox"/>		DPD I							
Direct axis sub-transient time constant <i>(PC.A.5.3.2(a))</i>	S	<input type="checkbox"/>		DPD I							
Quadrature axis sub-transient time constant <i>(PC.A.5.3.2(a))</i>	S	<input type="checkbox"/>		DPD I							
Stator time constant <i>(PC.A.5.3.2(a))</i>	S	<input type="checkbox"/>		DPD I							
MECHANICAL PARAMETERS											
<i>(PC.A.5.3.2(a))</i>											
The number of turbine generator masses		<input type="checkbox"/>		DPD II							
Diagram showing the Inertia and parameters for each turbine generator mass for the complete drive train	Kgm ²	<input type="checkbox"/>		DPD II							
Diagram showing Stiffness constants and parameters between each turbine generator mass for the complete drive train	Nm/rad	<input type="checkbox"/>		DPD II							
Number of poles		<input type="checkbox"/>		DPD II							
Relative power applied to different parts of the turbine	%	<input type="checkbox"/>		DPD II							
Torsional mode frequencies	HZ	<input type="checkbox"/>		DPD II							
Modal damping decrement factors for the different mechanical modes		<input type="checkbox"/>		DPD II							
GENERATING UNIT STEP-UP TRANSFORMER											
Rated MVA <i>(PC.A.3.3.1 & PC.A.5.3.2)</i>	MVA	<input type="checkbox"/>	<input checked="" type="checkbox"/>	SPD+							
Voltage Ratio <i>(PC.A.5.3.2)</i>	:	<input type="checkbox"/>		DPD I							
Positive sequence reactance: <i>(PC.A.5.3.2)</i>											
Max tap	% on MVA	<input type="checkbox"/>	<input checked="" type="checkbox"/>	SPD+							
Min tap	% on MVA	<input type="checkbox"/>	<input checked="" type="checkbox"/>	SPD+							
Nominal tap	% on MVA	<input type="checkbox"/>	<input checked="" type="checkbox"/>	SPD+							
Positive sequence resistance: <i>(PC.A.5.3.2)</i>											
Max tap	% on MVA	<input type="checkbox"/>		DPD II							
Min tap	% on MVA	<input type="checkbox"/>		DPD II							
Nominal tap	% on MVA	<input type="checkbox"/>		DPD II							
Zero phase sequence reactance <i>(PC.A.5.3.2)</i>	% on MVA	<input type="checkbox"/>		DPD II							
Tap change range <i>(PC.A.5.3.2)</i>	+% / -%	<input type="checkbox"/>		DPD II							
Tap change step size <i>(PC.A.5.3.2)</i>	%	<input type="checkbox"/>		DPD II							
Tap changer type: on-load or off-circuit <i>(PC.A.5.3.2)</i>	On/Off	<input type="checkbox"/>		DPD II							

(P.C.A.5.3.2(c))

described in block diagram form showing transfer functions of individual elements.

Diagram

DPD II

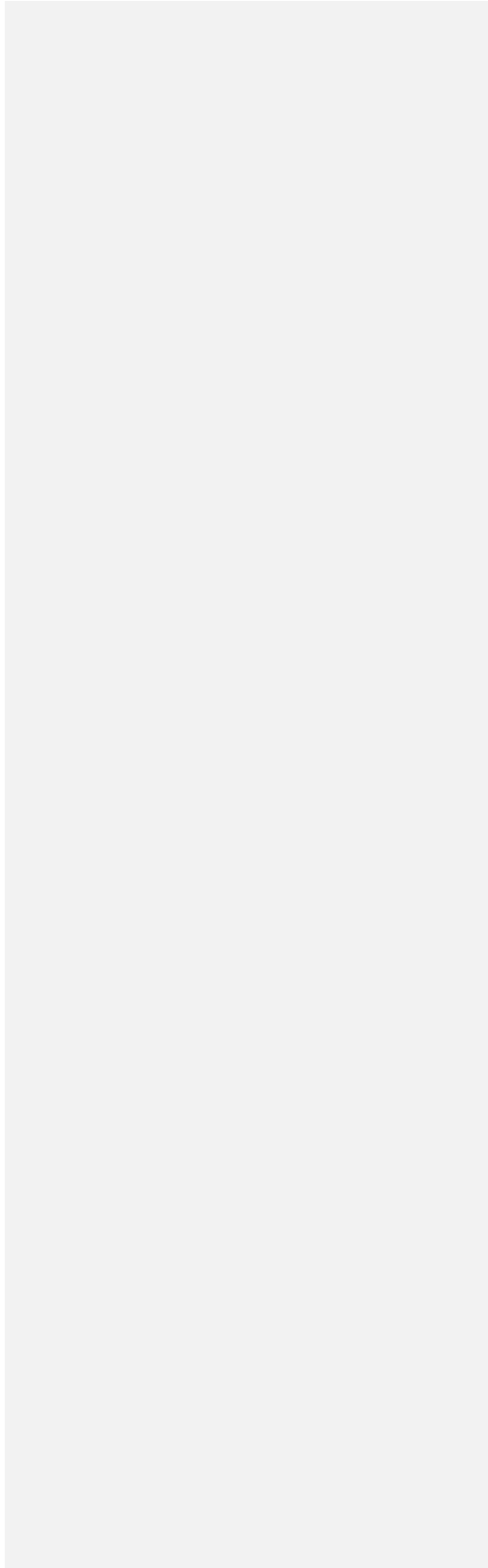

SCHEDULE 1 – POWER GENERATING MODULE, GENERATING UNIT (OR CCGT MODULE), POWER PARK MODULE, DC CONNECTED POWER PARK MODULE, HVDC SYSTEM AND DC CONVERTER TECHNICAL DATA

DATA DESCRIPTION	UNITS	DATA to		DATA CAT.	GENERATING UNIT OR STATION DATA						
		RTL	RTL		G1	G2	G3	G4	G5	G6	STN
GOVERNOR AND ASSOCIATED PRIME MOVER PARAMETERS											
<p>Note: The data items requested under Option 1 below may continue to be provided by Generators in relation to Generating Units on the System at 9 January 1995 (in this paragraph, the "relevant date") or they may provide the new data items set out under Option 2. Generators must supply the data as set out under Option 2 (and not those under Option 1) for Generating Unit and Synchronous Power Generating Unit governor control systems commissioned after the relevant date, those Generating Unit and Synchronous Power Generating Unit governor control systems recommissioned for any reason such as refurbishment after the relevant date and Generating Unit and Synchronous Power Generating Unit governor control systems where, as a result of testing or other process, the Generator is aware of the data items listed under Option 2 in relation to that Generating Unit and Synchronous Power Generating Unit.</p>											
Option 1											
GOVERNOR PARAMETERS (REHEAT UNITS) (PC.A.5.3.2(d) – Option 1(i))											
HP Governor average gain	MW/Hz	<input type="checkbox"/>	<input type="checkbox"/>	DPD II							
Speeder motor setting range	Hz	<input type="checkbox"/>	<input type="checkbox"/>	DPD II							
HP governor valve time constant	S	<input type="checkbox"/>	<input type="checkbox"/>	DPD II							
HP governor valve opening limits		<input type="checkbox"/>	<input type="checkbox"/>	DPD II							
HP governor valve rate limits		<input type="checkbox"/>	<input type="checkbox"/>	DPD II							
Re-heat time constant (stored Active Energy in reheater)	S	<input type="checkbox"/>	<input type="checkbox"/>	DPD II							
IP governor average gain	MW/Hz	<input type="checkbox"/>	<input type="checkbox"/>	DPD II							
IP governor setting range	Hz	<input type="checkbox"/>	<input type="checkbox"/>	DPD II							
IP governor time constant	S	<input type="checkbox"/>	<input type="checkbox"/>	DPD II							
IP governor valve opening limits		<input type="checkbox"/>	<input type="checkbox"/>	DPD II							
IP governor valve rate limits		<input type="checkbox"/>	<input type="checkbox"/>	DPD II							
Details of acceleration sensitive elements HP & IP in governor loop		<input type="checkbox"/>	<input type="checkbox"/>	DPD II	(please attach)						
Governor block diagram showing transfer functions of individual elements		<input type="checkbox"/>	<input type="checkbox"/>	DPD II	(please attach)						
GOVERNOR (Non-reheat steam and Gas Turbines) (PC.A.5.3.2(d) – Option 1(ii))											
Governor average gain	MW/Hz	<input type="checkbox"/>	<input type="checkbox"/>	DPD II							
Speeder motor setting range		<input type="checkbox"/>	<input type="checkbox"/>	DPD II							
Time constant of steam or fuel governor valve	S	<input type="checkbox"/>	<input type="checkbox"/>	DPD II							
Governor valve opening limits		<input type="checkbox"/>	<input type="checkbox"/>	DPD II							
Governor valve rate limits		<input type="checkbox"/>	<input type="checkbox"/>	DPD II							
Time constant of turbine	S	<input type="checkbox"/>	<input type="checkbox"/>	DPD II							
Governor block diagram		<input type="checkbox"/>	<input type="checkbox"/>	DPD II	(please attach)						

SCHEDULE 1 – POWER GENERATING MODULE, GENERATING UNIT (OR CCGT MODULE), POWER PARK MODULE DC CONNECTED POWER PARK MODULE, HVDC SYSTEM AND DC CONVERTER TECHNICAL DATA

DATA DESCRIPTION	UNITS	DATA to		DATA CAT.	GENERATING UNIT OR STATION DATA						
		RTL	Form		G1	G2	G3	G4	G5	G6	STN
<i>(PC.A.5.3.2(d) – Option 1(iii))</i>											
BOILER & STEAM TURBINE DATA*											
Boiler time constant (Stored Active Energy)	S			DPD II							
HP turbine response ratio: (Proportion of Primary Response arising from HP turbine)	%			DPD II							
HP turbine response ratio: (Proportion of High Frequency Response arising from HP turbine)	%			DPD II							
End of Option 1											
Option 2											
All Generating Units and Synchronous Power Generating Units											
Governor Block Diagram showing transfer function of individual elements including acceleration sensitive elements			<input type="checkbox"/>	DPD II							
Governor Time Constant <i>(PC.A.5.3.2(d) – Option 2(i))</i>	Sec		<input type="checkbox"/>	DPD II							
#Governor Deadband <i>(PC.A.5.3.2(d) – Option 2(i))</i>											
- Maximum Setting	±Hz		<input type="checkbox"/>	DPD II							
- Normal Setting	±Hz		<input type="checkbox"/>	DPD II							
- Minimum Setting	±Hz		<input type="checkbox"/>	DPD II							
Speeder Motor Setting Range <i>(PC.A.5.3.2(d) – Option 2(i))</i>	%		<input type="checkbox"/>	DPD II							
Average Gain <i>(PC.A.5.3.2(d) – Option 2(i))</i>	MW/Hz		<input type="checkbox"/>	DPD II							
Steam Units											
<i>(PC.A.5.3.2(d) – Option 2(ii))</i>											
HP Valve Time Constant	sec		<input type="checkbox"/>	DPD II							
HP Valve Opening Limits	%		<input type="checkbox"/>	DPD II							
HP Valve Opening Rate Limits	%/sec		<input type="checkbox"/>	DPD II							
HP Valve Closing Rate Limits	%/sec		<input type="checkbox"/>	DPD II							
HP Turbine Time Constant	sec		<input type="checkbox"/>	DPD II							
<i>(PC.A.5.3.2(d) – Option 2(ii))</i>											
IP Valve Time Constant	sec		<input type="checkbox"/>	DPD II							
IP Valve Opening Limits	%		<input type="checkbox"/>	DPD II							
IP Valve Opening Rate Limits	%/sec		<input type="checkbox"/>	DPD II							
IP Valve Closing Rate Limits	%/sec		<input type="checkbox"/>	DPD II							
IP Turbine Time Constant	sec		<input type="checkbox"/>	DPD II							
<i>(PC.A.5.3.2(d) – Option 2(ii))</i>											
LP Valve Time Constant	sec		<input type="checkbox"/>	DPD II							
LP Valve Opening Limits	%		<input type="checkbox"/>	DPD II							
LP Valve Opening Rate Limits	%/sec		<input type="checkbox"/>	DPD II							
LP Valve Closing Rate Limits	%/sec		<input type="checkbox"/>	DPD II							
LP Turbine Time Constant	sec		<input type="checkbox"/>	DPD II							
<i>(PC.A.5.3.2(d) – Option 2(ii))</i>											
Reheater Time Constant	sec			DPD II							
Boiler Time Constant	sec			DPD II							
HP Power Fraction	%			DPD II							
IP Power Fraction	%			DPD II							

Where the generating unit or synchronous power generating unit governor does not have a selectable deadband facility, then the actual value of the deadband need only be provided.

SCHEDULE 1 – POWER GENERATING MODULE, GENERATING UNIT (OR CCGT MODULE), POWER PARK MODULE, DC CONNECTED POWER PARK MODULE, HVDC SYSTEM AND DC CONVERTER TECHNICAL DATA

DATA DESCRIPTION	UNITS	DATA to		DATA CAT.	GENERATING UNIT OR STATION DATA									
		RTL			G1	G2	G3	G4	G5	G6	STN			
		<small>GUSC Contract</small>	<small>GUSC Appr. Form</small>											
Gas Turbine Units														
<i>(PC.A.5.3.2(d) – Option 2(iii))</i>														
Inlet Guide Vane Time Constant	sec	<input type="checkbox"/>		DPD II										
Inlet Guide Vane Opening Limits	%	<input type="checkbox"/>		DPD II										
Inlet Guide Vane Opening Rate Limits	%/sec	<input type="checkbox"/>		DPD II										
Inlet Guide Vane Closing Rate Limits	%/sec	<input type="checkbox"/>		DPD II										
<i>(PC.A.5.3.2(d) – Option 2(iii))</i>														
Fuel Valve Time Constant	sec	<input type="checkbox"/>		DPD II										
Fuel Valve Opening Limits	%	<input type="checkbox"/>		DPD II										
Fuel Valve Opening Rate Limits	%/sec	<input type="checkbox"/>		DPD II										
Fuel Valve Closing Rate Limits	%/sec	<input type="checkbox"/>		DPD II										
<i>(PC.A.5.3.2(d) – Option 2(iii))</i>														
Waste Heat Recovery Boiler Time Constant														
Hydro Generating Units														
<i>(PC.A.5.3.2(d) – Option 2(iv))</i>														
Guide Vane Actuator Time Constant	sec	<input type="checkbox"/>		DPD II										
Guide Vane Opening Limits	%	<input type="checkbox"/>		DPD II										
Guide Vane Opening Rate Limits	%/sec	<input type="checkbox"/>		DPD II										
Guide Vane Closing Rate Limits	%/sec	<input type="checkbox"/>		DPD II										
Water Time Constant	sec	<input type="checkbox"/>		DPD II										
End of Option 2														
UNIT CONTROL OPTIONS*														
<i>(PC.A.5.3.2(e))</i>														
Maximum droop	%	<input type="checkbox"/>		DPD II										
Normal droop	%	<input type="checkbox"/>		DPD II										
Minimum droop	%	<input type="checkbox"/>		DPD II										
Maximum frequency deadband	±Hz			DPD II										
Normal frequency deadband	±Hz			DPD II										
Minimum frequency deadband	±Hz			DPD II										
Maximum frequency Insensitivity ¹ Normal	±Hz			DPDII										
frequency Insensitivity ¹	±Hz			DPDII										
Minimum frequency Insensitivity ¹	±Hz			DPDII										
Maximum Output deadband	±MW			DPD II										
Normal Output deadband	±MW			DPD II										
Minimum Output deadband	±MW			DPD II										
Maximum Output Insensitivity ¹	±Hz			DPDII										
Normal Output Insensitivity ¹	±Hz			DPDII										
Minimum Output Insensitivity ¹	±Hz			DPDII										
Frequency settings between which Unit Load Controller droop applies:														
Maximum	Hz			DPD II										
Normal	Hz			DPD II										
Minimum	Hz			DPD II										
Sustained response normally selected	Yes/No			DPD II										

¹ Data required only in respect of Power

Generating Modules

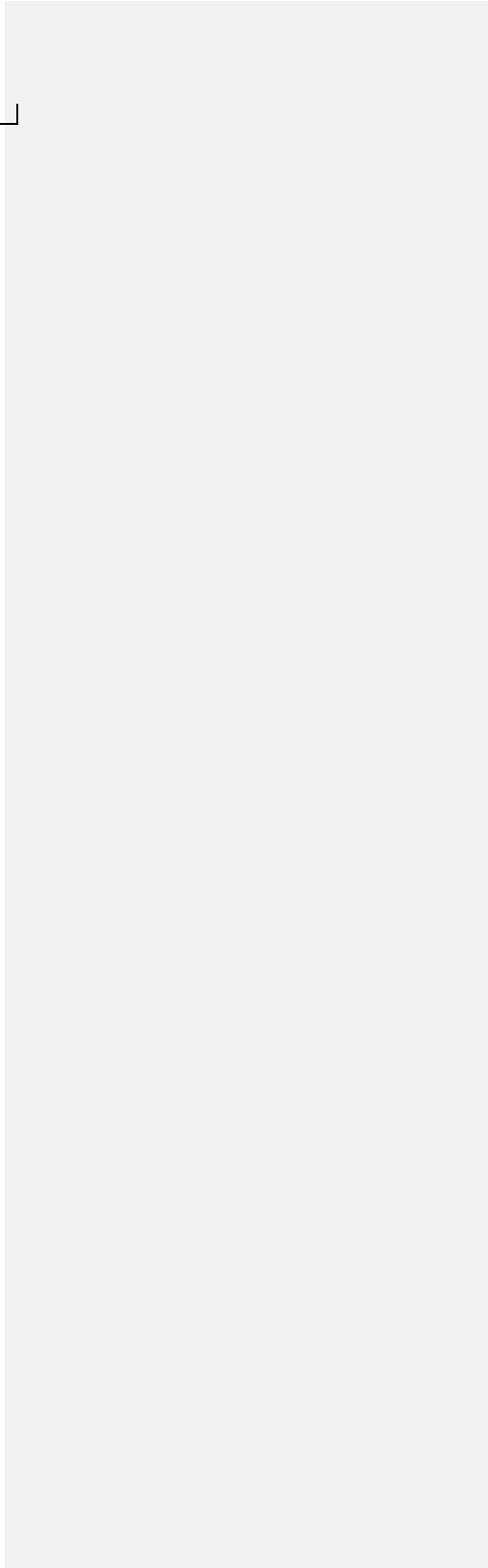

SCHEDULE 1 – POWER GENERATING MODULE, GENERATING UNIT (OR CCGT MODULE), POWER PARK MODULE, DC CONNECTED POWER PARK MODULE, HVDC SYSTEM AND DC CONVERTER TECHNICAL DATA

DATA DESCRIPTION	UNITS	DATA to		DATA CAT.	POWER PARK UNIT (OR POWER PARK MODULE, AS THE CASE MAY BE)							
		RTL	RTL		G1	G2	G3	G4	G5	G6	STN	
Power Park Module Rated MVA <i>(PC.A.3.3.1(a))</i>	MVA	<input type="checkbox"/>	<input checked="" type="checkbox"/>	SPD+								
Power Park Module Rated MW <i>(PC.A.3.3.1(a))</i>	MW	<input type="checkbox"/>	<input checked="" type="checkbox"/>	SPD+								
*Performance Chart of a Power Park Module at the connection point <i>(PC.A.3.2.2(f)(ii))</i>				SPD	<i>(see OC2 for specification)</i>							
*Output Usable (on a monthly basis) <i>(PC.A.3.2.2(b))</i>	MW			SPD	<i>(except in relation to CCGT Modules when required on a unit basis under the Grid Code, this data item may be supplied under Schedule 3)</i>							
Number & Type of Power Park Units within each Power Park Module <i>(PC.A.3.2.2(k))</i>		<input type="checkbox"/>		SPD								
Number & Type of Offshore Power Park Units within each Offshore Power Park String and the number of Offshore Power Park Strings and connection point within each Offshore Power Park Module <i>(PC.A.3.2.2.(k))</i>				SPD								
In the case where an appropriate Manufacturer's Data & Performance Report is registered with NGET then subject to NGET's agreement, the report reference may be given as an alternative to completion of the following sections of this Schedule 1 to the end of page 11 with the exception of the sections marked thus # below.	Reference the Manufacturer's Data & Performance Report			SPD								
Power Park Unit Model - A validated mathematical model in accordance with PC.5.4.2 (a)	Transfer function block diagram and algebraic equations, simulation and measured test results	<input type="checkbox"/>	<input type="checkbox"/>	DPD II								

SCHEDULE 1 – POWER GENERATING MODULE, GENERATING UNIT (OR CCGT MODULE), POWER PARK MODULE, DC CONNECTED POWER PARK MODULE, HVDC SYSTEM AND DC CONVERTER TECHNICAL DATA

DATA DESCRIPTION	UNITS	DATA to RTL		DATA CAT.	POWER PARK UNIT (OR POWER PARK MODULE, AS THE CASE MAY BE)						
		CUSG Contract	CUSG App. Form		G1	G2	G3	G4	G5	G6	STN
<p>Torque / Speed and blade angle control systems and parameters (PC.A.5.4.2(c))</p> <p>For the Power Park Unit, details of the torque / speed controller and blade angle controller in the case of a wind turbine and power limitation functions (where applicable) described in block diagram form showing transfer functions and parameters of individual elements</p>	Diagram	☑		DPD II							
<p># Voltage/Reactive Power/Power Factor control system parameters (PC.A.5.4.2(d))</p> <p># For the Power Park Unit and Power Park Module details of Voltage/Reactive Power/Power Factor controller (and PSS if fitted) described in block diagram form including parameters showing transfer functions of individual elements.</p>	Diagram	☑		DPD II							
<p># Frequency control system parameters (PC.A.5.4.2(e))</p> <p># For the Power Park Unit and Power Park Module details of the Frequency controller described in block diagram form showing transfer functions and parameters of individual elements.</p>	Diagram	☑		DPD II							
<p>As an alternative to PC.A.5.4.2 (a), (b), (c), (d), (e) and (f), is the submission of a single complete model that consists of the full information required under PC.A.5.4.2 (a), (b), (c), (d) (e) and (f) provided that all the information required under PC.A.5.4.2 (a), (b), (c), (d), (e) and (f) individually is clearly identifiable. (PC.A.5.4.2(g))</p>	Diagram	☑		DPD II							
<p># Harmonic Assessment Information (PC.A.5.4.2(h)) (as defined in IEC 61400-21 (2001)) for each Power Park Unit:</p>											
# Flicker coefficient for continuous operation		☑		DPD I							
# Flicker step factor		☑		DPD I							
# Number of switching operations in a 10 minute window		☑		DPD I							
# Number of switching operations in a 2 hour window		☑		DPD I							
# Voltage change factor		☑		DPD I							
# Current Injection at each harmonic for each Power Park Unit and for each Power Park Module	Tabular format	☑		DPD I							
<p>Note:- Generators who own or operate DC Connected Power Park Modules shall supply all data for their DC Connected Power Park Modules as applicable to Power Park Modules.</p>											

SCHEDULE 1 – POWER GENERATING MODULE, GENERATING UNIT (OR CCGT MODULE), POWER PARK MODULE, DC CONNECTED POWER PARK MODULE, HVDC SYSTEM AND DC CONVERTER TECHNICAL DATA

HVDC SYSTEM AND DC CONVERTER STATION TECHNICAL DATA

HVDC SYSTEM OR DC CONVERTER STATION NAME _____ DATE: _____

Data Description	Units	DATA to		Data Category	DC Converter Station Data
		RTL	Contract		
(PC.A.4)		CUSC Contract	CUSC Appl Form		
HVDC SYSTEM AND DC CONVERTER STATION DEMANDS:					
Demand supplied through Station Transformers associated with the DC Converter Station and HVDC System [PC.A.4.1]	MW MVA _r	<input type="checkbox"/>	<input type="checkbox"/>	DPD II DPD II	
- Demand with all DC Converters and HVDC Converters within and HVDC System operating at Rated MW import.	MW MVA _r	<input type="checkbox"/>	<input type="checkbox"/>	DPD II DPD II	
- Demand with all DC Converters and HVDC Converters within an HVDC System operating at Rated MW export.					
Additional Demand associated with the DC Converter Station or HVDC System supplied through the National Electricity Transmission System. [PC.A.4.1]	MW MVA _r	<input type="checkbox"/>	<input type="checkbox"/>	DPD II DPD II	
- The maximum Demand that could occur.	MW MVA _r	<input type="checkbox"/>	<input type="checkbox"/>	DPD II DPD II	
- Demand at specified time of annual peak half hour of NGET Demand at Annual ACS Conditions.	MW MVA _r	<input type="checkbox"/>	<input type="checkbox"/>	DPD II DPD II	
- Demand at specified time of annual minimum half-hour of NGET Demand.	Text	<input type="checkbox"/>	<input checked="" type="checkbox"/>	SPD+	
DC CONVERTER STATION AND HVDC SYSTEM DATA	Text	<input type="checkbox"/>	<input checked="" type="checkbox"/>	SPD+	
Number of poles, i.e. number of DC Converters or HVDC Converters within the HVDC System		<input type="checkbox"/>	<input checked="" type="checkbox"/>	SPD+	
Pole arrangement (e.g. monopole or bipole)		<input type="checkbox"/>	<input checked="" type="checkbox"/>		
Details of each viable operating configuration		<input type="checkbox"/>	<input checked="" type="checkbox"/>		
Configuration 1	Diagram	<input type="checkbox"/>	<input checked="" type="checkbox"/>	SPD	
Configuration 2	Diagram				
Configuration 3	Diagram				
Configuration 4	Diagram				
Configuration 5	Diagram				

Configuration 6	Diagram				
Remote ac connection arrangement	Diagram				

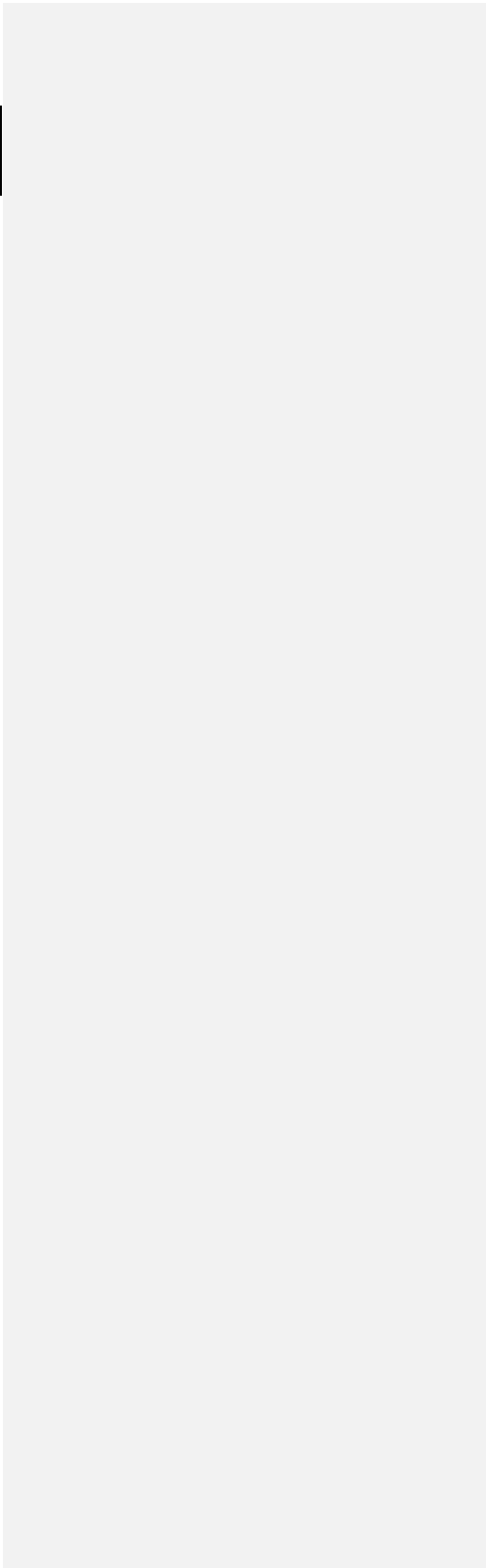

**SCHEDULE 1 – POWER PARK MODULE, GENERATING UNIT (OR CCGT MODULE),
POWER PARK MODULE, DC CONNECTED POWER PARK MODULE, HVDC SYSTEM
AND DC CONVERTER TECHNICAL DATA**

Data Description	Units	DATA to RTL		Data Category	Operating Configuration					
		CUSC Contract	CUSC App. Form		1	2	3	4	5	6
DC CONVERTER STATION AND HVDC SYSTEM DATA (PC.A.3.3.1d)										
DC Converter or HVDC Converter Type (e.g. current or Voltage source)	Text	■	■	SPD						
	Text	■	■	SPD						
Point of connection to the NGET Transmission System (or the Total System if Embedded) of the DC Converter Station or HVDC System configuration in terms of geographical and electrical location and system voltage	Section Number	■	■	SPD						
If the busbars at the Connection Point are normally run in separate sections identify the section to which the DC Converter Station or HVDC System configuration is connected										
Rated MW import per pole [PC.A.3.3.1]	MW	■	■	SPD +						
Rated MW export per pole [PC.A.3.3.1]	MW	■	■	SPD +						
ACTIVE POWER TRANSFER CAPABILITY (PC.A.3.2.2)										
Registered Capacity	MW	■	■	SPD						
Registered Import Capacity	MW	■	■	SPD						
Minimum Generation	MW	■	■	SPD						
Minimum Import Capacity	MW	■	■	SPD						
Maximum HVDC Active Power Transmission Capacity	MW	■	■	SPD						
Minimum Active Power Transmission Capacity	MW	■	■	SPD						
Import MW available in excess of Registered Import Capacity and Maximum Active Power Transmission Capacity	MW	■	■	SPD						
Time duration for which MW in excess of Registered Import Capacity is available	Min	■	■	SPD						
Export MW available in excess of Registered Capacity and Maximum Active Power Transmission Capacity	MW	■	■	SPD						
Time duration for which MW in excess of Registered Capacity is available	Min	■	■	SPD						

SCHEDULE 1 – POWER GENERATING MODULE, GENERATING UNIT (OR CCGT MODULE), DC CONNECTED POWER PARK MODULE, HVDC SYSTEM, POWER PARK MODULE AND DC CONVERTER TECHNICAL DATA

Data Description	Units	DATA to RTL		Data Category	Operating configuration					
		CUSC Contract	CUSC Appl Form		1	2	3	4	5	6
<p>DC NETWORK [PC.A.5.4.3.1 (c)]</p> <p>Rated DC voltage per pole Rated DC current per pole</p> <p>Details of the DC Network described in diagram form including resistance, inductance and capacitance of all DC cables and/or DC lines. Details of any line reactors (including line reactor resistance), line capacitors, DC filters, earthing electrodes and other conductors that form part of the DC Network should be shown.</p>	<p>kV A</p> <p>Diagram</p>	<p>■ ■ ■</p>		<p>DPD II DPD II</p> <p>DPD II</p>						
<p>DC CONVERTER STATION AND HVDC SYSTEM AC HARMONIC FILTER AND REACTIVE COMPENSATION EQUIPMENT [PC.A.5.4.3.1 (d)]</p> <p>For all switched reactive compensation equipment</p> <p>Total number of AC filter banks Diagram of filter connections Type of equipment (e.g. fixed or variable) Capacitive rating; or Inductive rating; or Operating range</p> <p>Reactive Power capability as a function of various MW transfer levels</p>	<p>Diagram</p> <p>Text Diagram Text MVar MVar MVar</p> <p>Table</p>	<p>■ ■ ■ ■ ■ ■ ■</p>		<p>DPD II</p> <p>DPD II DPD II DPD II DPD II DPD II</p> <p>DPD II</p>						

SCHEDULE 1 – POWER GENERATING MODULE, GENERATING UNIT (OR CCGT MODULE), POWER PARK MODULE, DC CONNECTED POWER PARK MODULE, HVDC SYSTEM AND DC CONVERTER TECHNICAL DATA

PAGE 18 OF 19

Data Description	Units	DATA to		Data Category	Operating configuration						
		RTL	RTL		1	2	3	4	5	6	
		CUSE Contract	CUSE App. Form								

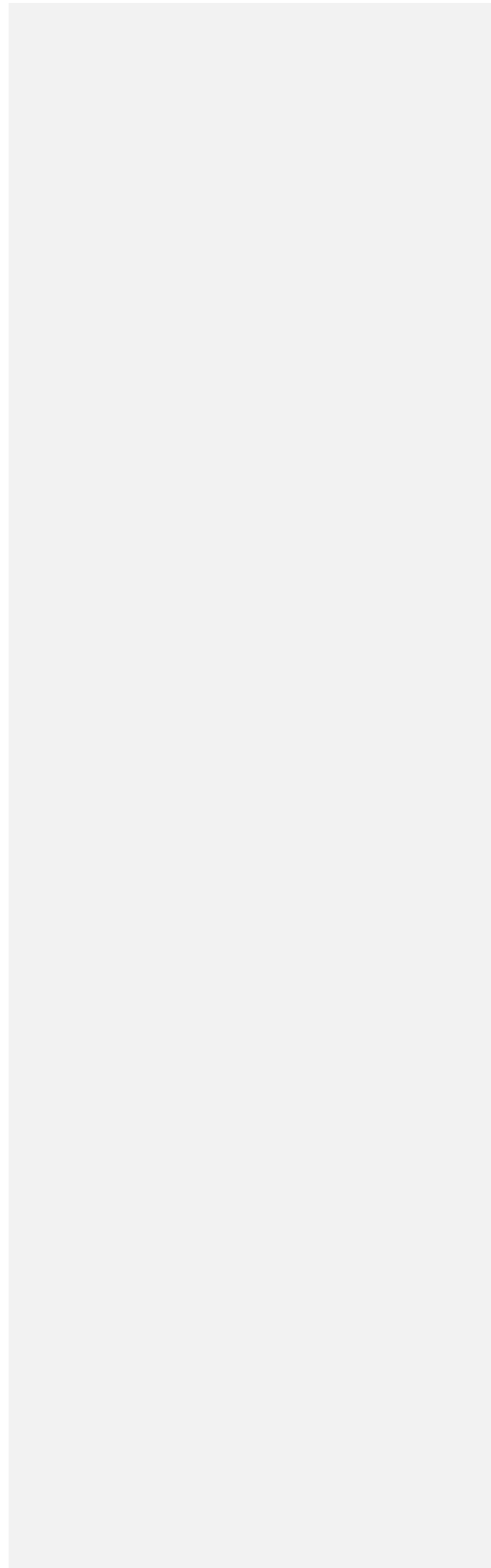

SCHEDULE 1 – POWER GENERATING MODULE, GENERATING UNIT (OR CCGT MODULE), POWER PARK MODULE, DC CONNECTED POWER PARK MODULE, HVDC SYSTEM AND DC CONVERTER TECHNICAL DATA

Data Description	Units	DATA to RTL		Data Category	Operating configuration					
		CUSC Contract	CUSC Appl. Form		1	2	3	4	5	6
LOADING PARAMETERS [PC.A.5.4.3.3]										
MW Export										
Nominal loading rate	MW/s			DPD I						
Maximum (emergency) loading rate	MW/s			DPD I						
MW Import										
Nominal loading rate	MW/s			DPD I						
Maximum (emergency) loading rate	MW/s			DPD I						
Maximum recovery time, to 90% of pre-fault loading, following an AC system fault or severe voltage depression.	s		☐	DPD II						
Maximum recovery time, to 90% of pre-fault loading, following a transient DC Network fault.	s		☐	DPD II						

NOTE: Users are referred to Schedules 5 & 14 which set down data required for all Users directly connected to the National Electricity Transmission System, including Power Stations. Generators undertaking OTSDUW Arrangements and are utilising an OTSDUW DC Converter are referred to Schedule 18.

Notice to Deviate from Zero (NDZ) after 48 hour Shutdown	Mins	■			OC2													
Station Synchronising Intervals (SI) after 48 hour Shutdown	Mins	■				■	■	■	■	■	■							
Synchronising Group (if applicable)	1 to 4	■			OC2													■

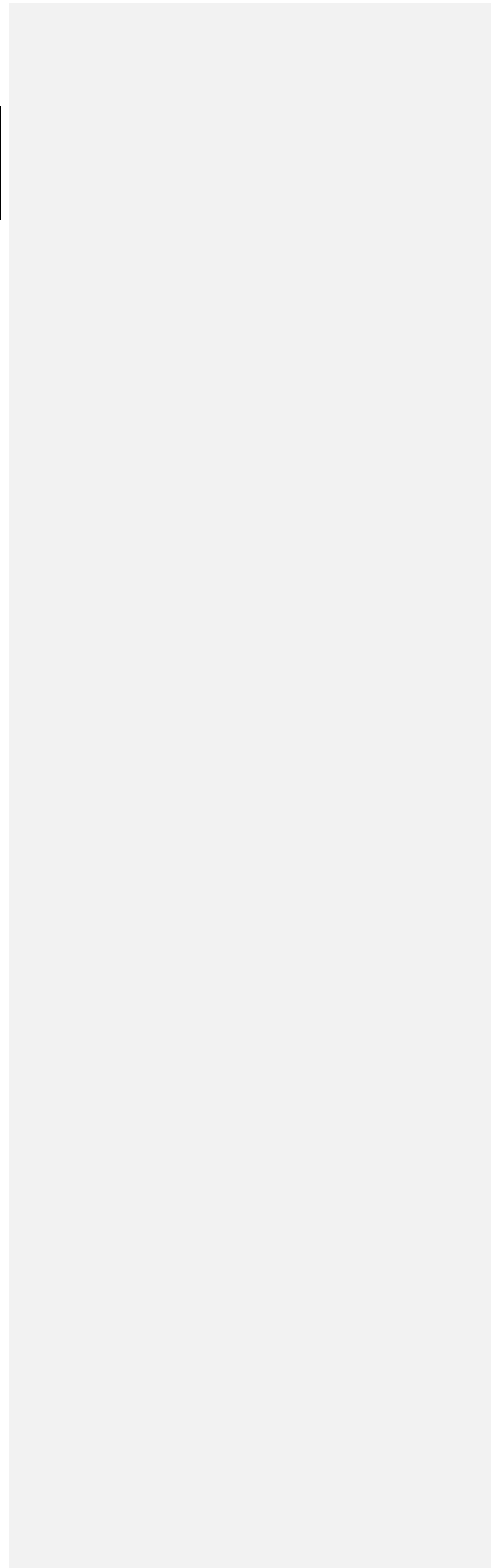

SCHEDULE 2 - GENERATION PLANNING PARAMETERS

PAGE 2 OF 3

DATA DESCRIPTION	UNITS	DATA to		DATA CAT.	GENSET OR STATION DATA							
		CUSC Contract	CUSC App. Form		G1	G2	G3	G4	G5	G6	STN	
Synchronising Generation (SYG) after 48 hour Shutdown <i>PC.A.5.3.2(f) & OC2.4.2.1(a)</i>	MW	■	■	DPD II & OC2								■
De-Synchronising Intervals (Single value) <i>OC2.4.2.1(a)</i>	Mins	■	■	OC2	■	■	■	■	■	■	■	
RUNNING AND SHUTDOWN PERIOD LIMITATIONS:												
Minimum Non Zero time (MNZT) after 48 hour Shutdown <i>OC2.4.2.1(a)</i>	Mins	■	■	OC2								
Minimum Zero time (MZT) <i>OC2.4.2.1(a)</i>	Mins			OC2								
Existing AGR Plant Flexibility Limit (Existing AGR Plant only)	No.			OC2								
80% Reactor Thermal Power (expressed as Gross-Net MW) (Existing AGR Plant only)	MW			OC2								
Frequency Sensitive AGR Unit Limit (Frequency Sensitive AGR Units only)	No.			OC2								
RUN-UP PARAMETERS <i>PC.A.5.3.2(f) & OC2.4.2.1(a)</i>												
Run-up rates (RUR) after 48 hour Shutdown: (See note 2 page 3) MW Level 1 (MWL1) MW Level 2 (MWL2)	MW MW	■ ■	■ ■	OC2 OC2								■ ■
RUR from Synch. Gen to MWL1	MW/Mins	■	■	DPD II & OC2								
RUR from MWL1 to MWL2	MW/Mins	■	■	OC2								
RUR from MWL2 to RC	MW/Mins	■	■	OC2								
Run-Down Rates (RDR): (Note that for DPD only a single value of run-down rate from Registered Capacity to de-synch is required)												
MWL2 RDR from RC to MWL2	MW MW/Min	■ ■	■ ■	OC2 DPD II								
MWL1 RDR from MWL2 to MWL1	MW MW/Min	■ ■	■ ■	OC2 OC2								
RDR from MWL1 to de-synch	MW/Min	■	■	OC2								

SCHEDULE 2 - GENERATION PLANNING PARAMETERS

PAGE 3 OF 3

DATA DESCRIPTION	UNITS	DATA to		DATA CAT.	GENSET OR STATION DATA							
		RTL CUSC Contract	CUSC App. Form		G1	G2	G3	G4	G5	G6	STN	
REGULATION PARAMETERS												
OC2.4.2.1(a) Regulating Range	MW	■		DPD II								
Load rejection capability while still Synchronised and able to supply Load.	MW	■		DPD II								
GAS TURBINE LOADING PARAMETERS:												
OC2.4.2.1(a) Fast loading	MW/Min	■		OC2								
Slow loading	MW/Min	■		OC2								
CCGT MODULE PLANNING MATRIX				OC2	(please attach)							
POWER PARK MODULE PLANNING MATRIX				OC2	(please attach)							
Power Park Module Active Power Output/ Intermittent Power Source Curve (eg MW output / Wind speed)				OC2	(please attach)							

NOTES:

- (1) To allow for different groups of **Gensets** within a **Power Station** (eg. **Gensets** with the same operator) each **Genset** may be allocated to one of up to four **Synchronising Groups**. Within each such **Synchronising Group** the single synchronising interval will apply but between **Synchronising Groups** a zero synchronising interval will be assumed.
- (2) The run-up of a **Genset** from synchronising block load to **Registered Capacity** or **Maximum Capacity** is represented as a three stage characteristic in which the run-up rate changes at two intermediate loads, MWL1 and MWL2. The values MWL1 & MWL2 can be different for each **Genset**.

SCHEDULE 3 - LARGE POWER STATION OUTAGE PROGRAMMES, OUTPUT USABLE AND INFLEXIBILITY INFORMATION

PAGE 1 OF 3

(Also outline information on contracts involving **External Interconnections**)

For a **Generating Unit** at a **Large Power Station** the information is to be submitted on a unit basis and for a **CCGT Module** or **Power Park Module** at a **Large Power Station** the information is to be submitted on a module basis, unless otherwise stated.

DATA DESCRIPTION	UNITS	TIME COVERED	UPDATE TIME	DATA CAT.	DATA to RTL
Power Station name:..... Generating Unit (or CCGT Module or Power Park Module at a Large Power Station) number:.... Registered Capacity:.....					
Large Power Station OUTAGE PROGRAMME	Large Power Station OUTPUT USABLE				
PLANNING FOR YEARS 3 - 7 AHEAD (OC2.4.1.2.1(a)(i), (e) & (j))					
Monthly average OU	MW	F. yrs 5 - 7	Week 24	SPD	CUSC Contract CUSC Est Form
Provisional outage programme comprising: duration preferred start earliest start latest finish	weeks date date date	C. yrs 3 - 5	Week 2	OC2	
Weekly OU	MW				
(NGET response as detailed in OC2 (Existing Users' response to NGET suggested changes or potential outages)		C. yrs 3 - 5 C. yrs 3 - 5	Week12 Week14		
Updated provisional outage programme comprising: duration preferred start earliest start latest finish Updated weekly OU	weeks date date date MW	C. yrs 3 - 5	Week 25	OC2	
(NGET response as detailed in OC2 for (Existing Users' response to NGET suggested changes or update of potential outages)		C. yrs 3 - 5 C. yrs 3 - 5	Week28 Week31		
(NGET further suggested revisions etc. (as detailed in OC2 for		C. yrs 3 - 5	Week42)		
Agreement of final Generation Outage Programme		C. yrs 3 - 5	Week 45	OC2	
PLANNING FOR YEARS 1 - 2 AHEAD (OC2.4.1.2.2(a) & OC2.4.1.2.2(i))					
Update of previously agreed Final Generation Outage Programme		C. yrs 1 - 2	Week 10	OC2	
Weekly OU	MW				

**SCHEDULE 3 - LARGE POWER STATION OUTAGE PROGRAMMES, OUTPUT
USABLE AND INFLEXIBILITY INFORMATION**

PAGE 2 OF 3

DATA DESCRIPTION	UNITS	TIME COVERED	UPDATE TIME	DATA CAT	DATA to RTL				
(NGET response as detailed in OC2 for (Users' response to NGET suggested changes or update of potential outages)		C. yrs 1 – 2 C. yrs 1 – 2	Week 12) Week 14)		<table border="0"> <tr> <td>OC2</td> <td>■</td> </tr> <tr> <td>OC2</td> <td>■</td> </tr> </table>	OC2	■	OC2	■
OC2	■								
OC2	■								
Revised weekly OU		C. yrs 1 – 2	Week 34	OC2	■				
(NGET response as detailed in OC2 for (Users' response to NGET suggested changes or update of potential outages)		C. yrs 1 – 2 C. yrs 1 – 2	Week 39) Week 46)		<table border="0"> <tr> <td>OC2</td> <td>■</td> </tr> <tr> <td>OC2</td> <td>■</td> </tr> </table>	OC2	■	OC2	■
OC2	■								
OC2	■								
Agreement of final Generation Outage Programme		C. yrs 1 – 2	Week 48	OC2	■				
PLANNING FOR YEAR 0									
Updated Final Generation Outage Programme			C. yr 0 Week 2 ahead to year end	1600 Weds.	OC2				
OU at weekly peak	MW								
(NGET response as detailed in OC2 for (C. yrs 0	Weeks 2 to 52 ahead	1600 Friday)					
(NGET response as detailed in OC2 for (Weeks 2 - 7	ahead	1600 Thurs)					
Forecast return to services (Planned Outage or breakdown)	date	days 2 to 14	ahead	0900 daily	OC2				
OU (all hours)	MW				OC2				
(NGET response as detailed in OC2 for (days 2 to 14	ahead	1600 daily)					
INFLEXIBILITY									
Genset inflexibility	Min MW (Weekly)	Weeks 2 - 8	ahead	1600 Tues	OC2				
(NGET response on Negative Reserve Active (Power Margin				1200 Friday)					
Genset inflexibility	Min MW (daily)	days 2-14	ahead	0900 daily	OC2				
(NGET response on Negative Reserve Active (Power Margin				1600 daily)					

**SCHEDULE 3 - LARGE POWER STATION OUTAGE PROGRAMMES, OUTPUT
USABLE AND INFLEXIBILITY INFORMATION
PAGE 3 OF 3**

DATA DESCRIPTION	UNITS	TIME COVERED	UPDATE TIME	DATA CAT	DATA to RTL		
OUTPUT PROFILES							
In the case of Large Power Stations whose output may be expected to vary in a random manner (eg. wind power) or to some other pattern (eg. Tidal) sufficient information is required to enable an understanding of the possible profile	MW	F. yrs 1 - 7	Week 24	SPD		CUSC Contract	CUSC Appl. Form

Notes: 1. The week numbers quoted in the Update Time column refer to standard weeks in the current year.

SCHEDULE 4 - LARGE POWER STATION DROOP AND RESPONSE DATA

GOVERNOR DROOP AND RESPONSE (PCA.5.5 ■ CUSC Contract)
 The Data in this Schedule 4 is to be supplied by Generators with respect to all Large Power Stations, HVDC System Owners and by DC Converter Station owners (where agreed), whether directly connected or Embedded

DATA DESCRIPTION	NORMAL VALUE	MW	DATA CAT	DROOP%			RESPONSE CAPABILITY		
				Unit 1	Unit 2	Unit 3	Primary	Secondary	High Frequency
MLP1 Designed Minimum Operating Level or Minimum Regulating Level (for a CCGT Module or Power Park Module, on a modular basis assuming all units are Synchronised)									
MLP2 Minimum Generation or Minimum Stable Operating Level (for a CCGT Module or Power Park Module, or Power Generating Module on a modular basis assuming all units are Synchronised)									
MLP3 70% of Registered Capacity or MAXIMUM CAPABILITY/MAXIMUM CAPACITY									
MLP4 80% of Registered Capacity or Maximum Capacity									
MLP5 95% of Registered Capacity or Maximum Capacity									
MLP6 Registered Capacity or Maximum Capacity									

NOTES:

- The data provided in this Schedule 4 is not intended to constrain any Ancillary Services Agreement.
- Registered Capacity or Maximum Capacity should be identical to that provided in Schedule 2.
- The Governor Droop should be provided for each Generating Unit (excluding Power Park Units), Power Park Module, HVDC Converter or DC Converter. The Response Capability should be provided for each Genset or DC Converter.
- Primary, Secondary and High Frequency Response are defined in CC.A.3.2 and are based on a frequency ramp of 0.5Hz over 10 seconds. Primary Response is the minimum value of response between 10s and 30s after the frequency ramp starts, Secondary Response between 30s and 30 minutes, and High Frequency Response is the minimum value after 10s on an indefinite basis.
- For plants which have not yet Synchronised, the data values of MLP1 to MLP6 should be as described above. For plants which have already Synchronised, the values of MLP1 to MLP6 can take any value between Designed Operating Minimum Level or Minimum Regulating Level and Registered Capacity or Maximum Capacity. If MLP1 is not provided at the Designed Minimum Operating Level, the value of the Designed Minimum Operating Level should be separately stated.
- For the avoidance of doubt Transmission DC Converters and OTSDUW DC Converters must be capable of providing a continuous signal indicating the real time frequency measured at the Transmission Interface Point to the Offshore Grid Entry Point (as detailed in CC.6.3.7(vi) and CC.6.3.7(vii)) to enable Offshore Power Generating Modules Offshore Generating Units, Offshore Power Park Modules and/or Offshore DC Converters to satisfy the frequency response requirements of CC.6.3.7.

SCHEDULE 5 - USERS SYSTEM DATA

PAGE 1 OF 10

The data in this Schedule 5 is required from **Users** who are connected to the **National Electricity Transmission System** via a **Connection Point** (or who are seeking such a connection). **Generators** undertaking **OTSDUW** should use **DRC** Schedule 18 although they should still supply data under Schedule 5 in relation to their **User's System** up to the **Offshore Grid Entry Point**.

DATA DESCRIPTION	UNITS	DATA to RTL		DATA CATEGORY
		CUSC Contract	CUSC App. Form	
<p>USERS SYSTEM LAYOUT (PC.A.2.2)</p> <p>A Single Line Diagram showing all or part of the User's System is required. This diagram shall include:-</p> <p>(a) all parts of the User's System, whether existing or proposed, operating at Supergrid Voltage, and in Scotland and Offshore, also all parts of the User System operating at 132kV,</p> <p>(b) all parts of the User's System operating at a voltage of 50kV, and in Scotland and Offshore greater than 30kV, or higher which can interconnect Connection Points, or split bus-bars at a single Connection Point,</p> <p>(c) all parts of the User's System between Embedded Medium Power Stations or Large Power Stations or Offshore Transmission Systems connected to the User's Subtransmission System and the relevant Connection Point or Interface Point,</p> <p>(d) all parts of the User's System at a Transmission Site.</p> <p>The Single Line Diagram may also include additional details of the User's Subtransmission System, and the transformers connecting the User's Subtransmission System to a lower voltage. With NGET's agreement, it may also include details of the User's System at a voltage below the voltage of the Subtransmission System.</p> <p>This Single Line Diagram shall depict the arrangement(s) of all of the existing and proposed load current carrying Apparatus relating to both existing and proposed Connection Points, showing electrical circuitry (ie. overhead lines, underground cables, power transformers and similar equipment), operating voltages. In addition, for equipment operating at a Supergrid Voltage, and in Scotland and Offshore also at 132kV, circuit breakers and phasing arrangements shall be shown.</p>		■	■	SPD

SCHEDULE 5 - USERS SYSTEM DATA

PAGE 2 OF 110

DATA DESCRIPTION	UNITS	DATA EXCH		DATA CATEGORY
		CUSC Contract	CUSC App. Form	
REACTIVE COMPENSATION (PC.A.2.4)				
For independently switched reactive compensation equipment not owned by a Transmission Licensee connected to the User's System at 132kV and above, and also in Scotland and Offshore , connected at 33kV and above, other than power factor correction equipment associated with a customers Plant or Apparatus :				
Type of equipment (eg. fixed or variable)	Text	▪	▪	SPD
Capacitive rating; or	MVA _r	▪	▪	SPD
Inductive rating; or	MVA _r	▪	▪	SPD
Operating range	MVA _r	▪	▪	SPD
Details of automatic control logic to enable operating characteristics to be determined	text and/or diagrams	▪	▪	SPD
Point of connection to User's System (electrical location and system voltage)	Text	▪	▪	SPD
SUBSTATION INFRASTRUCTURE (PC.A.2.2.6(b))				
For the infrastructure associated with any User's equipment at a Substation owned by a Transmission Licensee or operated or managed by NGET :-				
Rated 3-phase rms short-circuit withstand current	kA	▪	▪	SPD
Rated 1-phase rms short-circuit withstand current	kA	▪	▪	SPD
Rated Duration of short-circuit withstand	s	▪	▪	SPD
Rated rms continuous current	A	▪	▪	SPD

SCHEDULE 5 – USERS SYSTEM DATA

PAGE 3 OF 110

DATA DESCRIPTION		UNITS	DATA EXCH		DATA CATEGORY
LUMPED SUSCEPTANCES (PC.A.2.3)			CUSC Contract	CUSC App. Form	
Equivalent Lumped Susceptance required for all parts of the User's Subtransmission System which are not included in the Single Line Diagram .			■	■	
This should not include:			■	■	
(a)	independently switched reactive compensation equipment identified above.		■	■	
(b)	any susceptance of the User's System inherent in the Demand (Reactive Power) data provided in Schedule 1 (Generator Data) or Schedule 11 (Connection Point data).		■	■	
Equivalent lumped shunt susceptance at nominal Frequency .		% on 100 MVA	■	■	SPD

USER'S SYSTEM DATA

Circuit Parameters (PC-A.2.2.4) (■ CUSC Contract & ■ CUSC Application Form)

The data below is all **Standard Planning Data**. Details are to be given for all circuits shown on the **Single Line Diagram**

Years Valid	Node 1	Node 2	Rated Voltage kV	Operating Voltage kV	Positive Phase Sequence % on 100 MVA			Zero Phase Sequence (self) % on 100 MVA			Zero Phase Sequence (mutual) % on 100 MVA		
					R	X	B	R	X	B	R	X	B
					R	X	B	R	X	B	R	X	B

Notes

1. Data should be supplied for the current, and each of the seven succeeding Financial Years. This should be done by showing for which years the data is valid in the first column of the Table.

USERS SYSTEM DATA

Transformer Data (PC.A.2.2.5) (■ CUSC Contract & ■ CUSC Application Form)

The data below is all **Standard Planning Data**, and details should be shown below of all transformers shown on the **Single Line Diagram**. Details of Winding Arrangement, Tap Changer and earthing details are only required for transformers connecting the **User's** higher voltage system with its **Primary Voltage System**.

SCHEDULE 5 – USERS SYSTEM DATA
PAGE 5 OF 110

Years valid	Name of Node or Connection Data	Transformer	Rating MVA	Voltage Ratio		Positive Phase Sequence Reactance % on Rating			Positive Phase Sequence Resistance % on Rating			Zero Sequence Reactance % on Rating	Winding Arr.	Tap Changer			Earthing Details (delete as app.) *			
				HV	LV	Max. Tap	Min. Tap	Nom. Tap	Max. Tap	Min. Tap	Nom. Tap			range +% to -%	step size %	type (delete)				
																	Direct/Res/Rea	ON/OFF		
																	Direct/Res/Rea	ON/OFF		
																	Direct/Res/Rea	ON/OFF		
																	Direct/Res/Rea	ON/OFF		
																	Direct/Res/Rea	ON/OFF		
																	Direct/Res/Rea	ON/OFF		
																	Direct/Res/Rea	ON/OFF		

*If Resistance or Reactance please give impedance value

Notes

1. Data should be supplied for the current, and each of the seven succeeding Financial Years. This should be done by showing for which years the data is valid in the first column of the Table
2. For a transformer with two secondary windings, the positive and zero phase sequence leakage impedances between the HV and LV1, HV and LV2, and LV1 and LV2 windings are required.

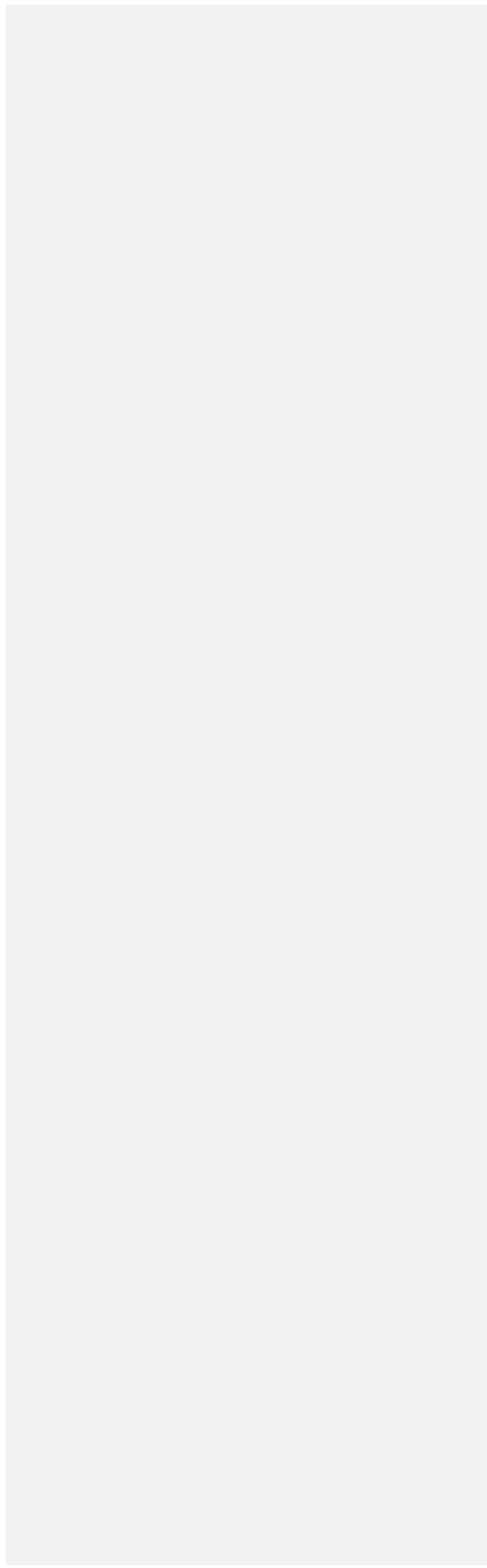

USER'S SYSTEM DATA

Switchgear Data (PC.A.2.6(a)) (CUSC Contract & CUSC Application Form)

The data below is all **Standard Planning Data**, and should be provided for all switchgear (ie. circuit breakers, load disconnectors and disconnectors) operating at a **Supergrid Voltage**, and also in Scotland and **Offshore**, operating at 132kV. In addition, data should be provided for all circuit breakers irrespective of voltage located at a **Connection Site** which is owned by a **Transmission Licensee** or operated or managed by **NGET**.

SCHEDULE 5 –USERS SYSTEM DATA
PAGE 6 OF 110

Years Valid	Connection Point	Switch No.	Rated Voltage kV rms	Operating Voltage kV rms	Rated short-circuit breaking current		Rated short-circuit peak making current		Rated rms continuous current (A)	DC time constant at testing of asymmetrical breaking ability(s)
					3 Phase kA rms	1 Phase kA rms	3 Phase kA peak	1 Phase kA peak		

Notes

1. Rated Voltage should be as defined by IEC 694.
2. Data should be supplied for the current, and each of the seven succeeding Financial Years. This should be done by showing for which years the data is valid in the first column of the Table

SCHEDULE 5 - USERS SYSTEM DATA

PAGE 8 OF 110

Information for Transient Overvoltage Assessment (DPD I) (PC.A.6.2 ■ CUSC Contract)

The information listed below may be requested by **NGET** from each **User** with respect to any **Connection Site** between that **User** and the **National Electricity Transmission System**. The impact of any third party **Embedded** within the **Users System** should be reflected.

- (a) Busbar layout plan(s), including dimensions and geometry showing positioning of any current and voltage transformers, through bushings, support insulators, disconnectors, circuit breakers, surge arresters, etc. Electrical parameters of any associated current and voltage transformers, stray capacitances of wall bushings and support insulators, and grading capacitances of circuit breakers;
- (b) Electrical parameters and physical construction details of lines and cables connected at that busbar. Electrical parameters of all plant e.g., transformers (including neutral earthing impedance or zig-zag transformers if any), series reactors and shunt compensation equipment connected at that busbar (or to the tertiary of a transformer) or by lines or cables to that busbar;
- (c) Basic insulation levels (BIL) of all **Apparatus** connected directly, by lines or by cables to the busbar;
- (d) Characteristics of overvoltage **Protection** devices at the busbar and at the termination points of all lines, and all cables connected to the busbar;
- (e) Fault levels at the lower voltage terminals of each transformer connected directly or indirectly to the **National Electricity Transmission System** without intermediate transformation;
- (f) The following data is required on all transformers operating at **Supergrid Voltage** throughout **Great Britain** and, in Scotland and **Offshore**, also at 132kV: three or five limb cores or single phase units to be specified, and operating peak flux density at nominal voltage.
- (g) An indication of which items of equipment may be out of service simultaneously during **Planned Outage** conditions.

Harmonic Studies (DPD I) (PC.A.6.4 ■ CUSC Contract)

The information given below, both current and forecast, where not already supplied in this Schedule 5 may be requested by **NGET** from each **User** if it is necessary for **NGET** to evaluate the production/magnification of harmonic distortion on the **National Electricity Transmission System** and **User's** systems. The impact of any third party **Embedded** within the **User's System** should be reflected:

- (a) Overhead lines and underground cable circuits of the **User's Subtransmission System** must be differentiated and the following data provided separately for each type:
 - Positive phase sequence resistance
 - Positive phase sequence reactance
 - Positive phase sequence susceptance
- (b) for all transformers connecting the **User's Subtransmission System** to a lower voltage:
 - Rated MVA
 - Voltage Ratio
 - Positive phase sequence resistance
 - Positive phase sequence reactance

SCHEDULE 5 – USERS SYSTEM DATA

PAGE 9 OF 110

- (c) at the lower voltage points of those connecting transformers:
- Equivalent positive phase sequence susceptance
 - Connection voltage and MVA_r rating of any capacitor bank and component design parameters if configured as a filter
 - Equivalent positive phase sequence interconnection impedance with other lower voltage points
 - The minimum and maximum **Demand** (both MW and MVA_r) that could occur
 - Harmonic current injection sources in Amps at the Connection voltage points
 - Details of traction loads, eg connection phase pairs, continuous variation with time, etc.
- (d) an indication of which items of equipment may be out of service simultaneously during **Planned Outage** conditions

Voltage Assessment Studies (DPD I) (PC.A.6.5 ■ CUSC Contract)

The information listed below, where not already supplied in this Schedule 5, may be requested by **NGET** from each **User** with respect to any **Connection Site** if it is necessary for **NGET** to undertake detailed voltage assessment studies (eg to examine potential voltage instability, voltage control co-ordination or to calculate voltage step changes). The impact of any third party **Embedded** within the **Users System** should be reflected:

- (a) For all circuits of the **User's Subtransmission System**:
- Positive Phase Sequence Reactance
 - Positive Phase Sequence Resistance
 - Positive Phase Sequence Susceptance
 - MVA_r rating of any reactive compensation equipment
- (b) for all transformers connecting the **User's Subtransmission System** to a lower voltage:
- Rated MVA
 - Voltage Ratio
 - Positive phase sequence resistance
 - Positive Phase sequence reactance
 - Tap-changer range
 - Number of tap steps
 - Tap-changer type: on-load or off-circuit
 - AVC/tap-changer time delay to first tap movement
 - AVC/tap-changer inter-tap time delay

SCHEDULE 5 – USERS SYSTEM DATA

PAGE 10 OF 119

- (c) at the lower voltage points of those connecting transformers:-
 - Equivalent positive phase sequence susceptance
 - MVA_r rating of any reactive compensation equipment
 - Equivalent positive phase sequence interconnection impedance with other lower voltage points
 - The maximum **Demand** (both MW and MVA_r) that could occur
 - Estimate of voltage insensitive (constant power) load content in % of total load at both winter peak and 75% off-peak load conditions

Short Circuit Analyses:(DPD I) (PC.A.6.6 ■ CUSC Contract)

The information listed below, both current and forecast, and where not already supplied under this Schedule 5, may be requested by **NGET** from each **User** with respect to any **Connection Site** where prospective short-circuit currents on equipment owned by a **Transmission Licensee** or operated or managed by **NGET** are close to the equipment rating. The impact of any third party **Embedded** within the **User's System** should be reflected:-

- (a) For all circuits of the **User's Subtransmission System**:
 - Positive phase sequence resistance
 - Positive phase sequence reactance
 - Positive phase sequence susceptance
 - Zero phase sequence resistance (both self and mutuals)
 - Zero phase sequence reactance (both self and mutuals)
 - Zero phase sequence susceptance (both self and mutuals)
- (b) for all transformers connecting the **User's Subtransmission System** to a lower voltage:
 - Rated MVA
 - Voltage Ratio
 - Positive phase sequence resistance (at max, min and nominal tap)
 - Positive Phase sequence reactance (at max, min and nominal tap)
 - Zero phase sequence reactance (at nominal tap)
 - Tap changer range
 - Earthing method: direct, resistance or reactance
 - Impedance if not directly earthed
- (c) at the lower voltage points of those connecting transformers:-
 - The maximum **Demand** (in MW and MVA_r) that could occur
 - Short-circuit infeed data in accordance with PC.A.2.5.6(a) unless the **User's** lower voltage network runs in parallel with the **Subtransmission System**, when to prevent double counting in each node infeed data, a π equivalent comprising the data items of PC.A.2.5.6(a) for each node together with the positive phase sequence interconnection impedance between the nodes shall be submitted.

SCHEDULE 5 – USERS SYSTEM DATA
PAGE 11 OF 11

Dynamic Models: (DPD II) (PC.A.6.7 ■ CUSC Contract)

The information listed below, both current and forecast, and where not already supplied under this Schedule 5, may be requested by **NET** from each **EU Code User** or in respect of each **EU Grid Supply Point** only with respect to any **Connection Site**

- (a) Dynamic model structure and block diagrams including parameters, ———transfer functions and individual elements (as applicable)
- (b) Power control functions and block diagrams including parameters, ———transfer functions and individual elements (as applicable)
- (c) Voltage control functions and block diagrams including parameters, ———transfer - functions and individual elements (as applicable)
- (d) Converter control models and block diagrams including parameters, ———transfer –functions and individual elements (as applicable)

Formatted: Underline, Font color: Auto

Formatted: Level 1 Text, Indent: Left: 0.5 cm, Right: 1 cm, Tab stops: 1 cm, Left + Not at 2 cm

Formatted: Font: Bold

Formatted: Font: Bold

Formatted: Indent: Left: 1.25 cm, Hanging: 2 cm, Numbered + Level: 1 + Numbering Style: a, b, c, ... + Start at: 1 + Alignment: Left + Aligned at: 4.2 cm + Indent at: 4.83 cm, Tab stops: 1 cm, Left + 1.5 cm, Left + 4 cm, Left

SCHEDULE 6 – USERS OUTAGE INFORMATION

PAGE 1 OF 2

DATA DESCRIPTION	UNITS	DATA to RTL		TIMESCALE COVERED	UPDATE TIME	DATA CAT.	
		CUSC Contract	CUSC App. Form				
<p>Details are required from Network Operators of proposed outages in their User Systems and from Generators with respect to their outages, which may affect the performance of the Total System (eg. at a Connection Point or constraining Embedded Large Power Stations or constraints to the Maximum Import Capacity or Maximum Export Capacity at an Interface Point) (OC2.4.1.3.2(a) & (b))</p> <p>(NGET advises Network Operators of National Electricity Transmission System outages affecting their Systems)</p> <p>Network Operator informs NGET if unhappy with proposed outages)</p> <p>(NGET draws up revised National Electricity Transmission System (outage plan advises Users of operational effects)</p> <p>Generators and Non-Embedded Customers provide Details of Apparatus owned by them (other than Gensets) at each Grid Supply Point (OC2.4.1.3.3)</p> <p>(NGET advises Network Operators of outages affecting their Systems) (OC2.4.1.3.3)</p> <p>Network Operator details of relevant outages affecting the Total System (OC2.4.1.3.3)</p> <p>Details of:- Maximum Import Capacity for each Interface Point Maximum Export Capacity for each Interface Point Changes to previously declared values of the Interface Point Target Voltage/Power Factor (OC2.4.1.3.3(c)).</p> <p>(NGET informs Users of aspects that may affect their Systems) (OC2.4.1.3.3)</p> <p>Users inform NGET if unhappy with aspects as notified (OC2.4.1.3.3)</p> <p>(NGET issues final National Electricity Transmission System (outage plan with advice of operational) (OC2.4.1.3.3) (effects on Users System)</p> <p>Generator, Network Operator and Non-Embedded Customers to inform NGET of changes to outages previously requested</p> <p>Details of load transfer capability of 12MW or more between Grid Supply Points in England and Wales and 10MW or more between Grid Supply Points in Scotland.</p> <p>Details of:- Maximum Import Capacity for each Interface Point Maximum Export Capacity for each Interface Point Changes to previously declared values of the Interface Point Target Voltage/Power Factor</p>		■		Years 2-5	Week 8 (Network Operator etc) Week 13 (Generators)	OC2	
					Years 2-5	Week 28)	OC2
			■		"	Week 30	OC2
					"	Week 34)	
			■		Year 1	Week 13	OC2
					Year 1	Week 28)	
			■		Year 1	Week 32	OC2
		MVA / MW MVA / MW V (unless power factor control			Year 1	Week 32	OC2
					Year 1	Week 34)	
			■		Year 1	Week 36	OC2
			■		Year 1	Week 49	OC2
					Week 8 ahead to year end	As occurring	OC2
					Within Yr 0	As NGET request	OC2
		MVA / MW MVA / MW V (unless power factor control			Within Yr 0	As occurring	OC2

Note: Users should refer to **OC2** for full details of the procedure summarised above and for the information which NGET will provide on the **Programming Phase**.

SCHEDULE 6 – USERS OUTAGE INFORMATION
PAGE 2 OF 2

The data below is to be provided to **NGET** as required for compliance with the European Commission Regulation No 543/2013 (OC2.4.2.3). Data provided under Article Numbers 7.1(a), 7.1(b), 15.1(a), 15.1(b), and 15.1(c) and 15.1(d) is to be provided using **MODIS**.

ECR ARTICLE No.	DATA DESCRIPTION	EXISTING USERS PROVIDING DATA	FREQUENCY OF SUBMISSION
7.1(a)	Planned unavailability of the Apparatus belonging to a Non-Embedded Customer where OC2.4.7 (a) applies <ul style="list-style-type: none"> - Energy Identification Code (EIC)* - Unavailable demand capacity during the event (MW) - Estimated start date and time (dd.mm.yy hh:mm) - Estimated end date and time (dd.mm.yy hh:mm) - Reason for unavailability from the list below: <ul style="list-style-type: none"> . Maintenance . Failure . Shutdown . Other 	Non-Embedded Customer	To be received by NGET as soon as reasonably possible but in any case to facilitate publication of data no later than 1 hour after a decision has been made by the Non-Embedded Customer regarding the planned unavailability
7.1(b)	Changes in actual availability of the Apparatus belonging to a Non-Embedded Customer where OC2.4.7 (b) applies <ul style="list-style-type: none"> - Energy Identification Code (EIC)* - Unavailable demand capacity during the event (MW) - Start date and time (dd.mm.yy hh:mm) - Estimated end date and time (dd.mm.yy hh:mm) - Reason for unavailability from the list below : <ul style="list-style-type: none"> . Maintenance . Failure . Shutdown . Other 	Non-Embedded Customer	To be received by NGET as soon as reasonably possible but in any case to facilitate publication of data no later than 1 hour after the change in actual availability
8.1	Year Ahead Forecast Margin information as provided in accordance with OC2.4.1.2.2 <ul style="list-style-type: none"> - Output Usable 	Generator	In accordance with OC2.4.1.2.2
14.1(a)	Registered Capacity or Maximum Capacity for Generating Units or Power Generating Modules with greater than 1 MW Registered Capacity or Maximum Capacity provided in accordance with PC.4.3.1 and PC.A.3.4.3 or PC.A.3.1.4 <ul style="list-style-type: none"> - Registered Capacity or Maximum Capacity (MW) - Production type (from that listed under PC.A.3.4.3) 	Generator	Week 24
14.1(b)	Power Station Registered Capacity for units with equal or greater than 100 MW Registered Capacity provided in accordance with PC.4.3.1 and PC.A.3.4.3 <ul style="list-style-type: none"> - Power Station name - Location of Generating Unit - Production type (from that listed under PC.A.3.4.3) - Voltage connection levels - Registered Capacity or Maximum Capacity (MW) 	Generator	Week 24
14.1(c)	Estimated output of Active Power of a BM Unit or Generating Unit for each per Settlement Period of the next Operational Day provided in accordance with BC1.4.2 <ul style="list-style-type: none"> - Physical Notification 	Generator	In accordance with BC1.4.2

15.1(a)	Planned unavailability of a Generating Unit where OC2.4.7(c) applies <ul style="list-style-type: none"> - Power Station name - Generating Unit and/or Power Generating Module name - Location of Generating Unit and/or Power Generating Module - Generating Unit Registered Capacity (MW) - Production type (from that listed under PC.A.3.4.3) - Output Usable (MW) during the event - Start date and time (dd.mm.yy hh:mm) - Estimated end date and time (dd.mm.yy hh:mm) - Reason for unavailability from the list below: <ul style="list-style-type: none"> . Maintenance . Shutdown . Other 	Generator	To be received by NET as soon as reasonably possible <i>possible</i> but in any case to facilitate publication of data no later than 1 hour after a decision has been made by the Generator regarding the planned unavailability
15.1(b)	Changes in availability of a Generating Unit and/or Power Generating Module where OC2.4.7 (d) applies <ul style="list-style-type: none"> - Power Station name - Generating Unit and/or Power Generating Module name - Location of Generating Unit and/or Power Generating Module - Generating Unit Registered Capacity and Power Generating Module Maximum Capacity (MW) - Production type (from that listed under PC.A.3.4.3) - Maximum Export Limit (MW) during the event - Start date and time (dd.mm.yy hh:mm) - Estimated end date and time (dd.mm.yy hh:mm) - Reason for unavailability from the list below: <ul style="list-style-type: none"> . Maintenance . Shutdown . Other 	Generator	To be received by NET as soon as reasonably possible but in any case to facilitate publication of data no later than 1 hour after the change in actual availability
15.1(c)	Planned unavailability of a Power Station where OC2.4.7(e) applies <ul style="list-style-type: none"> - Power Station name - Location of Power Station - Power Station Registered Capacity (MW) - Production type (from that listed under PC.A.3.4.3) - Power Station aggregated Output Usable (MW) during the event - Start date and time (dd.mm.yy hh:mm) - Estimated end date and time (dd.mm.yy hh:mm) - Reason for unavailability from the list below: <ul style="list-style-type: none"> . Maintenance . Shutdown . Other 	Generator	To be received by NET as soon as reasonably possible but in any case to facilitate publication of data no later than 1 hour after a decision has been made by the Generator regarding the planned unavailability
15.1(d)	Changes in actual availability of a Power Station where OC2.4.7 (f) applies <ul style="list-style-type: none"> - Power Station name - Location of Power Station - Power Station Registered Capacity (MW) - Production type (from that listed under PC.A.3.4.3) - Power Station aggregated Maximum Export Limit (MW) during the event - Start date and time (dd.mm.yy hh:mm) - Estimated end date and time (dd.mm.yy hh:mm) - Reason for unavailability from the list below: <ul style="list-style-type: none"> . Maintenance . Shutdown . Other 	Generator	To be received by NET as soon as reasonably possible <i>possible</i> but in any case to facilitate publication of data no later than 1 hour after the change in actual availability

* Energy Identification Coding (EIC) is a coding scheme that is approved by ENTSO-E for standardised electronic data interchanges and is utilised for reporting to the Central European Transparency Platform. NGET will act as the Local Issuing Office for IEC in respect of GB.

SCHEDULE 8 - DATA SUPPLIED BY BM PARTICIPANTS
PAGE 1 OF 1

CODE	DESCRIPTION
BC1	Physical Notifications
BC1	Quiescent Physical Notifications
BC1 & BC2	Export and Import Limits
BC1	Bid-Offer Data
BC1	Dynamic Parameters (Day Ahead)
BC2	Dynamic Parameters (For use in Balancing Mechanism)
BC1 & BC2	Other Relevant Data
BC1	Joint BM Unit Data

- No information collated under this Schedule will be transferred to the **Relevant Transmission Licensees**

SCHEDULE 9 - DATA SUPPLIED BY NGET TO USERS

PAGE 1 OF 1

(Example of data to be supplied)

CODE	DESCRIPTION
CC	Operation Diagram
CC	Site Responsibility Schedules
PC	Day of the peak National Electricity Transmission System Demand Day of the minimum National Electricity Transmission System Demand
OC2	Surpluses and OU requirements for each Generator over varying timescales Equivalent networks to Users for Outage Planning Negative Reserve Active Power Margins (when necessary) Operating Reserve information
BC1	Demand Estimates, Indicated Margin and Indicated Imbalance , indicative Synchronising and Desynchronising times of Embedded Power Stations to Network Operators , special actions.
BC2	Bid-Offer Acceptances, Ancillary Services instructions to relevant Users , Emergency Instructions
BC3	Location, amount, and Low Frequency Relay settings of any Low Frequency Relay initiated Demand reduction for Demand which is Embedded .

- No information collated under this Schedule will be transferred to the **Relevant Transmission Licensees**

DATA TO BE SUPPLIED BY NGET TO EXISTING USERS

PURSUANT TO THE TRANSMISSION LICENCE

1. The **Transmission Licence** requires **NGET** to publish annually the **Seven Year Statement** which is designed to provide **Users** and potential **Users** with information to enable them to identify opportunities for continued and further use of the **National Electricity Transmission System**.

When an **User** is considering a development at a specific site, certain additional information may be required in relation to that site which is of such a level of detail that it is inappropriate to include it in the **Seven Year Statement**. In these circumstances the **User** may contact **NGET** who will be pleased to arrange a discussion and the provision of such additional information relevant to the site under consideration as the **User** may reasonably require.

2. The **Transmission Licence** also requires **NGET** to offer terms for an agreement for connection to and use of the **National Electricity Transmission System** and further information will be given by **NGET** to the potential **User** in the course of the discussions of the terms of such an agreement.

SCHEDULE 10 - DEMAND PROFILES AND ACTIVE ENERGY DATA
PAGE 1 OF 2

The following information is required from each **Network Operator** and from each **Non-Embedded Customer**. The data should be provided in calendar week 24 each year (although **Network Operators** may delay the submission until calendar week 28).

DATA DESCRIPTION	F. Yr. 0	F. Yr. 1	F. Yr. 2	F. Yr. 3	F. Yr. 4	F. Yr. 5	F. Yr. 6	F. Yr. 7	UPDATE TIME	DATA CAT
<u>Demand Profiles</u>	<i>(PC.A.4.2) (■ – CUSC Contract & ■ CUSC Application Form)</i>									
Total User's system profile (please delete as applicable)	Day of User's annual Maximum demand at Annual ACS Conditions (MW) Day of annual peak of National Electricity Transmission System Demand at Annual ACS Conditions (MW) Day of annual minimum National Electricity Transmission System Demand at average conditions (MW)									
0000 : 0030									Wk.24	SPD
0030 : 0100									:	:
0100 : 0130									:	:
0130 : 0200									:	:
0200 : 0230									:	:
0230 : 0300									:	:
0300 : 0330									:	:
0330 : 0400									:	:
0400 : 0430									:	:
0430 : 0500									:	:
0500 : 0530									:	:
0530 : 0600									:	:
0600 : 0630									:	:
0630 : 0700									:	:
0700 : 0730									:	:
0730 : 0800									:	:
0800 : 0830									:	:
0830 : 0900									:	:
0900 : 0930									:	:
0930 : 1000									:	:
1000 : 1030									:	:
1030 : 1100									:	:
1100 : 1130									:	:
1130 : 1200									:	:
1200 : 1230									:	:
1230 : 1300									:	:
1300 : 1330									:	:
1330 : 1400									:	:
1400 : 1430									:	:
1430 : 1500									:	:
1500 : 1530									:	:
1530 : 1600									:	:
1600 : 1630									:	:
1630 : 1700									:	:
1700 : 1730									:	:
1730 : 1800									:	:
1800 : 1830									:	:
1830 : 1900									:	:
1900 : 1930									:	:
1930 : 2000									:	:
2000 : 2030									:	:
2030 : 2100									:	:
2100 : 2130									:	:
2130 : 2200									:	:
2200 : 2230									:	:
2230 : 2300									:	:
2300 : 2330									:	:
2330 : 0000									:	:

SCHEDULE 10 - DEMAND PROFILES AND ACTIVE ENERGY DATA
PAGE 2 OF 2

DATA DESCRIPTION	Out-turn		F.Yr. 0	Update Time	Data Cat	DATA to RTL	
	Actual	Weather Corrected.				CUSC Contract	CUSC App. Form
(PC.A.4.3) <u>Active Energy Data</u> Total annual Active Energy requirements under average conditions of each Network Operator and each Non-Embedded Customer in the following categories of Customer Tariff:- LV1 LV2 LV3 EHV HV Traction Lighting User System Losses Active Energy from Embedded Small Power Stations and Embedded Medium Power Stations				Week 24	SPD	■	■
						■	■
						■	■
						■	■
						■	■
						■	■
						■	■
						■	■
						■	■
						■	■

NOTES:

- 'F. yr.' means 'Financial Year'
- Demand and Active Energy Data (General)

Demand and Active Energy data should relate to the point of connection to the **National Electricity Transmission System** and should be net of the output (as reasonably considered appropriate by the User) of all **Embedded Small Power Stations, Medium Power Stations and Customer Generating Plant**. Auxiliary demand of **Embedded Power Stations** should be included in the demand data submitted by the **User** at the **Connection Point**. **Users** should refer to the **PC** for a full definition of the **Demand** to be included.
- Demand** profiles and **Active Energy** data should be for the total **System** of the **Network Operator**, including all **Connection Points**, and for each **Non-Embedded Customer**. **Demand Profiles** should give the numerical maximum demand that in the **User's** opinion could reasonably be imposed on the **National Electricity Transmission System**.
- In addition the demand profile is to be supplied for such days as **NET** may specify, but such a request is not to be made more than once per calendar year.

SCHEDULE 11 - CONNECTION POINT DATA
PAGE 1 OF 3

The following information is required from each **Network Operator** and from each **Non-Embedded Customer**. The data should be provided in calendar week 24 each year (although **Network Operators** may delay the submission until calendar week 28).

Connection Point:

Connection Point Demand at the time of - (select each one in turn) (Provide data for each Access Period associated with the Connection Point)	a) maximum Demand	PC.A.4.1.4.2
	b) peak National Electricity Transmission System Demand (specified by NGET)	
	c) minimum National Electricity Transmission System Demand (specified by NGET)	
	d) maximum Demand during Access Period	
	e) specified by either NGET or an User	
Name of Transmission Interface Circuit out of service during Access Period (if reqd).		

DATA DESCRIPTION (CUSC Contract □ & CUSC Application Form ■)	Outturn	Outturn Weather Corrected	F.Y.	F.Y.	F.Y.	F.Y.	F.Y.	F.Y.	F.Y.	F.Y.	F.Y.	DATA CAT
			1	2	3	4	5	6	7	8		
Date of a), b), c), d) or e) as denoted above.												PC.A.4.3.3
Time of a), b), c), d) or e) as denoted above.												PC.A.4.3.3
Connection Point Demand (MW)												PC.A.4.3.1
Connection Point Demand (MVA _r)												PC.A.4.3.1
Deduction made at Connection Point for Small Power Stations, Medium Power Stations and Customer Generating Plant (MW)												PC.A.4.3.2(a)
Reference to valid Single Line Diagram												PC.A.4.3.5
Reference to node and branch data.												PC.A.2.2

Note: The following data block can be repeated for each post fault network revision that may impact on the Transmission System.

Reference to post-fault revision of Single Line Diagram												PC.A.4.5
Reference to post-fault revision of the node and branch data associated with the Single Line Diagram												PC.A.4.5
Reference to the description of the actions and timescales involved in effecting the post-fault actions (e.g. auto-switching, manual, teleswitching, overload protection operation etc)												PC.A.4.5

Access Group:

Note: The following data block to be repeated for each **Connection Point** with the **Access Group**.

Name of associated Connection Point within the same Access Group :												PC.A.4.3.1
Demand at associated Connection Point (MW)												PC.A.4.3.1
Demand at associated Connection Point (MVA _r)												PC.A.4.3.1
Deduction made at associated Connection Point for Small Power Stations, Medium Power Stations and Customer Generating Plant (MW)												PC.A.4.3.2(a)

- Formatted: Character scale: 66%
- Formatted: Character scale: 66%, Expanded by 0.05 pt
- Formatted: Character scale: 66%, Not Expanded by / Condensed by
- Formatted: Character scale: 66%, Expanded by 0.05 pt
- Formatted: Character scale: 66%, Not Expanded by / Condensed by
- Formatted: Character scale: 66%, Expanded by 0.05 pt
- Formatted: Character scale: 66%, Not Expanded by / Condensed by
- Formatted: Character scale: 66%, Expanded by 0.05 pt
- Formatted: Character scale: 66%, Not Expanded by / Condensed by
- Formatted: Character scale: 66%, Expanded by 0.05 pt

SCHEDULE 11 - CONNECTION POINT DATA
PAGE 2 OF 3

Embedded Generation Data											
Connection Point:											
DATA DESCRIPTION	Outturn	Outturn Weather Corrected	F.Yr 1	F.Yr 2	F.Yr. 3	F.Yr. 4	F.Yr. 5	F.Yr 6	F.Yr 7	F.Yr 8	DATA CAT
<u>Small Power Station, Medium Power Station and Customer Generation Summary</u>	For each Connection Point where there are Embedded Small Power Stations, Medium Power Stations or Customer Generating Stations the following information is required:										
No. of Small Power Stations, Medium Power Stations or Customer Power Stations											PC.A.3.1.4(a)
Number of Generating Units or Power Generating Modules within these stations											PC.A.3.1.4(a)
Summated Capacity of all these Generating Units and/or Power Generating Modules											PC.A.3.1.4(a)
Where the Network Operator's System places a constraint on the capacity of an Embedded Large Power Station											
Station Name											PC.A.3.2.2(c)
Generating Unit											PC.A.3.2.2(c)
System Constrained Capacity											PC.A.3.2.2(c)(i)
Reactive Despatch Network Restriction											PC.A.3.2.2(c)(ii)

Where the Network Operator's System places a constraint on the capacity of an Offshore Transmission System at an Interface Point											
Offshore Transmission System Name											PC.A.3.2.2(c)
Interface Point Name											PC.A.3.2.2(c)
Maximum Export Capacity											PC.A.3.2.2(c)
Maximum Import Capacity											PC.A.3.2.2(c)

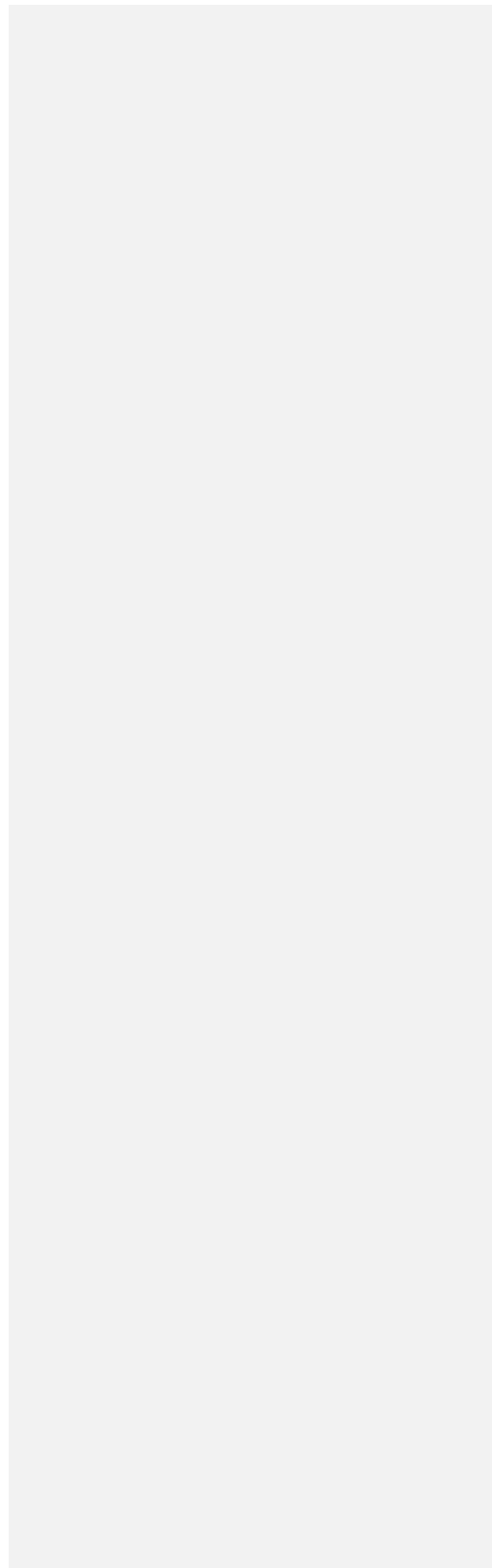

SCHEDULE 11 - CONNECTION POINT DATA
PAGE 3 OF 3

NOTES:

1. 'F.Yr.' means '**Financial Year**'. F.Yr. 1 refers to the current financial year.
2. All **Demand** data should be net of the output (as reasonably considered appropriate by the **User**) of all **Embedded Small Power Stations, Medium Power Stations and Customer Generating Plant**. Generation and / or Auxiliary demand of **Embedded Large Power Stations** should not be included in the demand data submitted by the **User**. **Users** should refer to the **PC** for a full definition of the **Demand** to be included.
3. Peak **Demand** should relate to each **Connection Point** individually and should give the maximum demand that in the **User's** opinion could reasonably be imposed on the **National Electricity Transmission System**. **Users** may submit the **Demand** data at each node on the **Single Line Diagram** instead of at a **Connection Point** as long as the **User** reasonably believes such data relates to the peak (or minimum) at the **Connection Point**.

In deriving **Demand** any deduction made by the **User** (as detailed in note 2 above) to allow for **Embedded Small Power Stations, Medium Power Stations and Customer Generating Plant** is to be specifically stated as indicated on the Schedule.
4. **NGET** may at its discretion require details of any **Embedded Small Power Stations or Embedded Medium Power Stations** whose output can be expected to vary in a random manner (eg. wind power) or according to some other pattern (eg. tidal power)
5. Where more than 95% of the total **Demand** at a **Connection Point** is taken by synchronous motors, values of the **Power Factor** at maximum and minimum continuous excitation may be given instead. **Power Factor** data should allow for series reactive losses on the **User's System** but exclude reactive compensation network susceptance specified separately in Schedule 5.
6. Where a **Reactive Despatch Network Restriction** is in place which requires the generator to maintain a target voltage set point this should be stated as an alternative to the size of the **Reactive Despatch Network Restriction**.

SCHEDULE 12 - DEMAND CONTROL
PAGE 1 OF 2

The following information is required from each **Network Operator** and where indicated with an asterisk from **Externally Interconnected System Operators** and/or **Interconnector Users** and a **Pumped Storage Generator**. Where indicated with a double asterisk, the information is only required from **Suppliers**.

DATA DESCRIPTION	UNITS		UPDATE TIME	
<u>Demand Control</u>				
Demand met or to be relieved by Demand Control (averaging at the Demand Control Notification Level or more over a half hour) at each Connection Point .				
Demand Control at time of National Electricity Transmission System weekly peak demand				
Amount	MW)F.yrs 0 to 5	Week 24	OC1
Duration	Min)		
For each half hour	MW	Wks 2-8 ahead	1000 Mon	OC1
For each half hour	MW	Days 2-12 ahead	1200 Wed	OC1
For each half hour	MW	Previous calendar day	0600 daily	OC1
**Customer Demand Management (at the Customer Demand Management Notification Level or more at the Connection Point)				
For each half hour	MW	Any time in Control Phase		OC1
For each half hour	MW	Remainder of period	When changes occur to previous plan	OC1
For each half hour	MW	Previous calendar day	0600 daily	OC1
**In Scotland, Load Management Blocks For each block of 5MW or more, for each half hour	MW	For the next day	11:00	OC1

SCHEDULE 12 - DEMAND CONTROL
PAGE 1 OF 2

DATA DESCRIPTION	UNITS	TIME COVERED	UPDATE TIME	DATA CAT.
*Demand Control or Pump Tripping Offered as Reserve				
Magnitude of Demand or pumping load which is tripped	MW	Year ahead from week 24	Week 24	DPD I
System Frequency at which tripping is initiated	Hz	"	"	"
Time duration of System Frequency below trip setting for tripping to be initiated	S	"	"	"
Time delay from trip initiation to Tripping	S	"	"	"
Emergency Manual Load Disconnection				
Method of achieving load disconnection	Text	Year ahead from week 24	Annual in week 24	OC6
Annual ACS Peak Demand (Active Power) at Connection Point (requested under Schedule 11 - repeated here for reference)	MW	"	"	"
Cumulative percentage of Connection Point Demand (Active Power) which can be disconnected by the following times from an instruction from NGET				
5 mins	%	"	"	"
10 mins	%	"	"	"
15 mins	%	"	"	"
20 mins	%	"	"	"
25 mins	%	"	"	"
30 mins	%	"	"	"

Notes:

- Network Operators** may delay the submission until calendar week 28.
- No information collated under this Schedule will be transferred to the **Relevant Transmission Licensees** (or **Generators** undertaking **OTSDUW**).

SCHEDULE 12A - AUTOMATIC LOW FREQUENCY DEMAND DISCONNECTION
PAGE 1 OF 1

Time Covered: Year ahead from week 24
 Update Time: Annual in week 24

Data Category: OC6

Grid Supply Point	GSP Demand MW	Low Frequency Demand Disconnection Blocks MW									Residual demand MW
		1 48.8Hz	2 48.75Hz	3 48.7Hz	4 48.6Hz	5 48.5Hz	6 48.4Hz	7 48.2Hz	8 48.0Hz	9 47.8Hz	
GSP1											
GSP2											
GSP3											
Total demand disconnected per block	MW %										
Total demand disconnection		MW (% of aggregate demand of MW)									

Note: All demand refers to that at the time of forecast **National Electricity Transmission System** peak demand.

Network Operators may delay the submission until calendar week 28

No information collated under this schedule will be transferred to the **Relevant Transmission Licensees** (or **Generators** undertaking **OTSDUW**).

SCHEDULE 13 - FAULT INFEED DATA
PAGE 1 OF 2

The data in this Schedule 13 is all **Standard Planning Data**, and is required from all **Users** other than **Generators** who are connected to the **National Electricity Transmission System** via a **Connection Point** (or who are seeking such a connection). A data submission is to be made each year in Week 24 (although **Network Operators** may delay the submission until Week 28). A separate submission is required for each node included in the **Single Line Diagram** provided in Schedule 5.

DATA DESCRIPTION	UNITS	F.Yr	F.Yr.	F.Yr.	F.Yr.	F.Yr.	F.Yr.	F.Yr.	F.Yr.	DATA to		
		0	1	2	3	4	5	6	7	RTL		
SHORT CIRCUIT INFEED TO THE NATIONAL ELECTRICITY TRANSMISSION SYSTEM FROM USERS SYSTEM AT A CONNECTION POINT <i>(PC.A.2.5)</i>											CUSC Contract	CUSC App. Form
Name of node or Connection Point											<input type="checkbox"/>	<input checked="" type="checkbox"/>
Symmetrical three phase short-circuit current infeed												
- at instant of fault	kA										<input type="checkbox"/>	<input checked="" type="checkbox"/>
- after subtransient fault current contribution has substantially decayed	Ka										<input type="checkbox"/>	<input checked="" type="checkbox"/>
Zero sequence source impedances as seen from the Point of Connection or node on the Single Line Diagram (as appropriate) consistent with the maximum infeed above:												
- Resistance	% on 100										<input type="checkbox"/>	<input checked="" type="checkbox"/>
- Reactance	% on 100										<input type="checkbox"/>	<input checked="" type="checkbox"/>
Positive sequence X/R ratio at instance of fault											<input type="checkbox"/>	<input checked="" type="checkbox"/>
Pre-Fault voltage magnitude at which the maximum fault currents were calculated	p.u.										<input type="checkbox"/>	<input checked="" type="checkbox"/>

SCHEDULE 13 - FAULT INFEED DATA
PAGE 2 OF 2

DATA DESCRIPTION	UNITS	F.Yr.	F.Yr.	F.Yr.	F.Yr.	F.Yr.	F.Yr.	F.Yr.	F.Yr.	DATA to		
		0	1	2	3	4	5	6	7	RTL		
SHORT CIRCUIT INFEED TO THE NATIONAL ELECTRICITY TRANSMISSION SYSTEM FROM USERS SYSTEM AT A CONNECTION POINT											CUSC Contract	CUSC App. Form
Negative sequence impedances of User's System as seen from the Point of Connection or node on the Single Line Diagram (as appropriate). If no data is given, it will be assumed that they are equal to the positive sequence values.												
- Resistance	% on 100										<input type="checkbox"/>	<input checked="" type="checkbox"/>
- Reactance	% on 100										<input type="checkbox"/>	<input checked="" type="checkbox"/>

SCHEDULE 14 - FAULT INFEED DATA (GENERATORS INCLUDING UNIT TRANSFORMERS AND STATION TRANSFORMERS)

PAGE 1 OF 5

The data in this Schedule 14 is all **Standard Planning Data**, and is to be provided by **Generators**, with respect to all directly connected **Power Stations**, all **Embedded Large Power Stations** and all **Embedded Medium Power Stations** connected to the **Subtransmission System**. A data submission is to be made each year in Week 24.

Fault infeeds via Unit Transformers

A submission should be made for each **Generating Unit** (including those which are part of a **Synchronous Power Generating Module**) with an associated **Unit Transformer**. Where there is more than one **Unit Transformer** associated with a **Generating Unit**, a value for the total infeed through all **Unit Transformers** should be provided. The infeed through the **Unit Transformer(s)** should include contributions from all motors normally connected to the **Unit Board**, together with any generation (eg **Auxiliary Gas Turbines**) which would normally be connected to the **Unit Board**, and should be expressed as a fault current at the **Generating Unit** terminals for a fault at that location.

- Formatted: Highlight
- Formatted: Highlight
- Formatted: Highlight
- Formatted: Highlight
- Formatted: Highlight

DATA DESCRIPTION	UNITS	F.Yr. 0	F.Yr. 1	F.Yr. 2	F.Yr. 3	F.Yr. 4	F.Yr. 5	F.Yr. 6	F.Yr. 7	DATA to RTL	DUSC Contract	DUSC App. Form
<i>(P.C.A.2.5)</i>												
Name of Power Station											<input type="checkbox"/>	<input type="checkbox"/>
Number of Unit Transformer											<input type="checkbox"/>	<input type="checkbox"/>
Symmetrical three phase short-circuit current infeed through the Unit Transformer(s) for a fault at the Generating Unit terminals											<input type="checkbox"/>	<input type="checkbox"/>
- at instant of fault	kA										<input type="checkbox"/>	<input type="checkbox"/>
- after subtransient fault current contribution has substantially decayed	kA										<input type="checkbox"/>	<input type="checkbox"/>
Positive sequence X/R ratio at instance of fault											<input type="checkbox"/>	<input type="checkbox"/>
Subtransient time constant (if significantly different from 40ms)	ms										<input type="checkbox"/>	<input type="checkbox"/>
Pre-fault voltage at fault point (if different from 1.0 p.u.)											<input type="checkbox"/>	<input type="checkbox"/>
The following data items need only be supplied if the Generating Unit Step-up Transformer can supply zero sequence current from the Generating Unit side to the National Electricity Transmission System											<input type="checkbox"/>	<input type="checkbox"/>
Zero sequence source impedances as seen from the Generating Unit terminals consistent with the maximum infeed above:											<input type="checkbox"/>	<input type="checkbox"/>
- Resistance	% on 100										<input type="checkbox"/>	<input type="checkbox"/>
- Reactance	% on 100										<input type="checkbox"/>	<input type="checkbox"/>

SCHEDULE 14 - FAULT INFEEED DATA (GENERATORS INCLUDING UNIT TRANSFORMERS AND STATION TRANSFORMERS)

Fault infeeds via Station Transformers

A submission is required for each **Station Transformer** directly connected to the **National Electricity Transmission System**. The submission should represent normal operating conditions when the maximum number of **Gensets** are **Synchronised** to the **System**, and should include the fault current from all motors normally connected to the **Station Board**, together with any Generation (eg **Auxiliary Gas Turbines**) which would normally be connected to the **Station Board**. The fault infeed should be expressed as a fault current at the hv terminals of the **Station Transformer** for a fault at that location.

If the submission for normal operating conditions does not represent the worst case, then a separate submission representing the maximum fault infeed that could occur in practice should be made.

DATA DESCRIPTION	UNITS	F.Yr.	F.Yr.	F.Yr.	F.Yr.	F.Yr.	F.Yr.	F.Yr.	F.Yr.	DATA to RTL	DATA to	
		0	1	2	3	4	5	6	7		CUSC Contract	CUSC App. Form
(PC.A.2.5)											<input type="checkbox"/>	<input type="checkbox"/>
Name of Power Station											<input type="checkbox"/>	<input type="checkbox"/>
Number of Station Transformer											<input type="checkbox"/>	<input type="checkbox"/>
Symmetrical three phase short-circuit current infeed for a fault at the Connection Point											<input type="checkbox"/>	<input type="checkbox"/>
- at instant of fault	kA										<input type="checkbox"/>	<input type="checkbox"/>
- after subtransient fault current contribution has substantially decayed	kA										<input type="checkbox"/>	<input type="checkbox"/>
Positive sequence X/R ratio At instance of fault											<input type="checkbox"/>	<input type="checkbox"/>
Subtransient time constant (if significantly different from 40ms)	mS										<input type="checkbox"/>	<input type="checkbox"/>
Pre-fault voltage (if different from 1.0 p.u.) at fault point (See note 1)											<input type="checkbox"/>	<input type="checkbox"/>
Zero sequence source Impedances as seen from the Point of Connection Consistent with the maximum Infeed above:											<input type="checkbox"/>	<input type="checkbox"/>
- Resistance	% on 100										<input type="checkbox"/>	<input type="checkbox"/>
- Reactance	% on 100										<input type="checkbox"/>	<input type="checkbox"/>

Note 1. The pre-fault voltage provided above should represent the voltage within the range 0.95 to 1.05 that gives the highest fault current

Note 2. % on 100 is an abbreviation for % on 100 MVA

SCHEDULE 14 - FAULT INFEEED DATA (GENERATORS INCLUDING UNIT TRANSFORMERS AND STATION TRANSFORMERS)

Fault infeeds from Power Park Modules

A submission is required for the whole **Power Park Module** and for each **Power Park Unit** type or equivalent. The submission shall represent operating conditions that result in the maximum fault infeed. The fault current from all motors normally connected to the **Power Park Unit's** electrical system shall be included. The fault infeed shall be expressed as a fault current at the terminals of the **Power Park Unit**, or the **Common Collection Busbar** if an equivalent **Single Line Diagram** and associated data as described in PC.A.2.2.2 is provided, and the **Grid Entry Point**, or **User System Entry Point** if **Embedded**, for a fault at the **Grid Entry Point**, or **User System Entry Point** if **Embedded**.

Should actual data in respect of fault infeeds be unavailable at the time of the application for a **CUSC Contract** or **Embedded Development Agreement**, a limited subset of the data, representing the maximum fault infeed that may result from all of the plant types being considered, shall be submitted. This data will, as a minimum, represent the root mean square of the positive, negative and zero sequence components of the fault current for both single phase and three phase solid faults at the **Grid Entry Point** (or **User System Entry Point** if **Embedded**) at the time of fault application and 50ms following fault application. Actual data in respect of fault infeeds shall be submitted to **NGET** as soon as it is available, in line with PC.A.1.2

DATA DESCRIPTION	UNITS	F.Yr. 0	F.Yr. 1	F.Yr. 2	F.Yr. 3	F.Yr. 4	F.Yr. 5	F.Yr. 6	F.Yr. 7	DATA to RTL	
<i>(PC.A.2.5)</i>										CUSC Contract	CUSC App. Form
Name of Power Station										<input type="checkbox"/>	<input type="checkbox"/>
Name of Power Park Module										<input type="checkbox"/>	<input type="checkbox"/>
Power Park Unit type										<input type="checkbox"/>	<input type="checkbox"/>
A submission shall be provided for the contribution of the entire Power Park Module and each type of Power Park Unit or equivalent to the positive, negative and zero sequence components of the short circuit current at the Power Park Unit terminals, or Common Collection Busbar , and Grid Entry Point or User System Entry Point if Embedded for											
(i) a solid symmetrical three phase short circuit										<input type="checkbox"/>	<input type="checkbox"/>
(ii) a solid single phase to earth short circuit										<input type="checkbox"/>	<input type="checkbox"/>
(iii) a solid phase to phase short circuit										<input type="checkbox"/>	<input type="checkbox"/>
(iv) a solid two phase to earth short circuit										<input type="checkbox"/>	<input type="checkbox"/>
at the Grid Entry Point or User System Entry Point if Embedded .										<input type="checkbox"/>	<input type="checkbox"/>
If protective controls are used and active for the above conditions, a submission shall be provided in the limiting case where the protective control is not active. This case may require application of a non-solid fault, resulting in a retained voltage at the fault point.										<input type="checkbox"/>	<input type="checkbox"/>

SCHEDULE 14 - FAULT INFEEED DATA (GENERATORS INCLUDING UNIT TRANSFORMERS AND STATION TRANSFORMERS)

PAGE 5 OF 5

DATA DESCRIPTION	UNITS	F.Yr. 0	F.Yr. 1	F.Yr. 2	F.Yr. 3	F.Yr. 4	F.Yr. 5	F.Yr. 6	F.Yr. 7	DATA to RTL	DATA DESCRIPTION
										CUSC Contract	CUSC App. Form
For Power Park Units that utilise a protective control, such as a crowbar circuit.											
additional rotor resistance applied to the Power Park Unit under a fault situation	% on MVA										
additional rotor reactance applied to the Power Park Unit under a fault situation.	% on MVA										
Positive sequence X/R ratio of the equivalent at time of fault at the Common Collection Busbar											
Minimum zero sequence impedance of the equivalent at a Common Collection Busbar											
Active Power generated pre-fault	MW										
Number of Power Park Units in equivalent generator											
Power Factor (lead or lag)											
Pre-fault voltage (if different from 1.0 p.u.) at fault point (See note 1)	p.u.										
Items of reactive compensation switched in pre-fault											

Note 1. The pre-fault voltage provided above should represent the voltage within the range 0.95 to 1.05 that gives the highest fault current

SCHEDULE 15 – MOTHBALLED POWER GENERATING MODULE, MOTHBALLED GENERATING UNIT, MOTHBALLED POWER PARK MODULE (INCLUDING MOTHBALLED DC CONNECTED POWER PARK MODULES), MOTHBALLED HVDC SYSTEMS, MOTHBALLED HVDC CONVERTERS, MOTHBALLED DC CONVERTERS AT A DC CONVERTER STATION AND ALTERNATIVE FUEL DATA

MOTHBALLED POWER GENERATING MODULES, MOTHBALLED GENERATING UNIT, MOTHBALLED POWER PARK MODULE (INCLUDING MOTHBALLED DC CONNECTED POWER PARK MODULES), MOTHBALLED HVDC SYSTEMS, MOTHBALLED HVDC CONVERTERS OR MOTHBALLED DC CONVERTER AT A DC CONVERTER STATION AND ALTERNATIVE FUEL DATA
 The following data items must be supplied with respect to each Mothballed Power Generating Module, Mothballed Generating Unit, Mothballed Power Park Module (including Mothballed DC Connected Power Park Modules), Mothballed HVDC Systems, Mothballed HVDC Converters or Mothballed DC Converters at a DC Converter station

Power Station _____ Generating Unit, Power Park Module or DC Converter Name (e.g. Unit _____)

DATA DESCRIPTIO N	UNITS	DATA CAT	GENERATING UNIT DATA					Total MW being returned
			<1 month	1-2 months	2-3 months	3-6 months	6-12 months	
MW output that can be returned to service	MW	DPD II						

Notes

- The time periods identified in the above table represent the estimated time it would take to return the Mothballed Power Generating Module, Mothballed Generating Unit, Mothballed Power Park Module (Mothballed DC Connected Power Park Modules), Mothballed HVDC Systems, Mothballed HVDC Converters or Mothballed DC Converter at a DC Converter Station to service once a decision to return has been made.
- Where a Mothballed Power Generating Module, Mothballed Generating Unit, Mothballed Power Park Module (including a Mothballed DC Connected Power Park Module), Mothballed HVDC System, Mothballed HVDC Converter or Mothballed DC Converter at a DC Converter Station can be physically returned in stages covering more than one of the time periods identified in the above table then information should be provided for each applicable time period.
- The estimated notice to physically return MW output to service should be determined in accordance with **Good Industry Practice** assuming normal working arrangements and normal plant procurement lead times.
- The MW output values in each time period should be incremental MW values, e.g. if 150MW could be returned in 2 – 3 months and an additional 50MW in 3 – 6 months then the values in the columns should be Nil, Nil, 150, 50, Nil, Nil, 200 respectively.
- Significant factors which may prevent the Mothballed Power Generating Module, Mothballed Generating Unit, Mothballed Power Park Module (Mothballed DC Connected Power Park Modules), Mothballed HVDC System, Mothballed HVDC Converter or Mothballed DC Converter at a DC Converter Station achieving the estimated values provided in this table, excluding factors relating to **Transmission Entry Capacity**, should be appended separately.

Formatted: Highlight
 Formatted: Highlight
 Formatted: Highlight
 Formatted: Highlight

Formatted: Highlight

Formatted: Highlight

SCHEDULE 15 – MOTHBALLED POWER GENERATING MODULES, MOTHBALLED GENERATING UNIT, MOTHBALLED POWER PARK MODULE (INCLUDING DC CONNECTED POWER PARK MODULES), MOTHBALLED HVDC SYSTEMS, MOTHBALLED HVDC CONVERTERS, MOTHBALLED DC CONVERTERS AT A DC CONVERTER STATION AND ALTERNATIVE FUEL DATA

ALTERNATIVE FUEL INFORMATION

The following data items for alternative fuels need only be supplied with respect to each **Generating Unit** whose primary fuel is gas including those which form part of a **Power Generating Module**.

Power Station	Generating Unit Name (e.g. Unit 1)			
	DATA DESCRIPTION	UNITS	DATA CAT	GENERATING UNIT DATA
Alternative Fuel Type (please specify)	Text		1	Oil distillate
CHANGEOVER TO ALTERNATIVE FUEL			2	Other gas*
For off-line changeover:			3	Other*
Time to carry out off-line fuel changeover	Minutes	DPD II	4	Other*
Maximum output following off-line changeover	MW	DPD II		
For on-line changeover:				
Time to carry out on-line fuel changeover	Minutes	DPD II		
Maximum output during on-line fuel changeover	MW	DPD II		
Maximum output following on-line changeover	MW	DPD II		
Maximum operating time at full load assuming:				
Typical stock levels	Hours	DPD II		
Maximum possible stock levels	Hours	DPD II		
Maximum rate of replacement of depleted stocks of alternative fuels on the basis of Good Industry Practice	MWh(electrical)/day	DPD II		
Is changeover to alternative fuel used in normal operating arrangements?	Text	DPD II		
Number of successful changeovers carried out in the last NGET Financial Year (** delete as appropriate)	Text	DPD II		

Formatted: Highlight

Formatted: Highlight

Formatted: Highlight

SCHEDULE 15 – MOTHBALLED POWER GENERATING MODULES, MOTHBALLED GENERATING UNIT, MOTHBALLED POWER PARK MODULE (INCLUDING MOTHBALLED DC CONNECTED POWER PARK MODULES), MOTHBALLED HVDC SYSTEMS, MOTHBALLED HVDC CONVERTERS MOTHBALLED DC CONVERTERS AT A DC CONVERTER STATION AND ALTERNATIVE FUEL DATA

DATA DESCRIPTION	UNITS	DATA CAT	GENERATING UNIT DATA			
			1	2	3	4
CHANGEOVER BACK TO MAIN FUEL						
For off-line changeover: Time to carry out off-line fuel channelover	Minutes					
For on-line changeover: Time to carry out on-line fuel channelover	Minutes					
Maximum output during on-line fuel channelover	MW					

Notes

1. Where a **Generating Unit** has the facilities installed to generate using more than one alternative fuel type details of each alternative fuel should be given.
2. Significant factors and their effects which may prevent the use of alternative fuels achieving the estimated values provided in this table (e.g. emissions limits, distilled water stocks etc.) should be appended separately.

- No information collated under this Schedule will be transferred to the **Relevant Transmission Licensees** |

SCHEDULE 16 - BLACK START INFORMATION

<p>BLACK START INFORMATION</p> <p>The following data/text items are required from each Generator for each BM Unit at a Large Power Station as detailed in PCA.5.7. Data is not required for Generating Units that are contracted to provide Black Start Capability. Power Generating Modules, Power Park Modules or Generating Units that have an Intermittent Power Source. The data should be provided in accordance with PCA.1.2 and also, where possible, upon request from NGET during a Black Start.</p>	<p>Data Description (PCA.5.7) (CUSC Contract)</p>	<p>Units</p>	<p>Data Category</p>
	<p>Assuming all BM Units were running immediately prior to the Total Shutdown or Partial Shutdown and in the event of loss of all external power supplies, provide the following information:</p>	<p>—</p>	<p>—</p>
<p>a) Expected time for the first and subsequent BM Units to be Synchronised, from the restoration of external power supplies, assuming external power supplies are not available for up to 24hrs</p>		<p>Tabular or Graphical</p>	<p>DPD II</p>
<p>b) Describe any likely issues that would have a significant impact on a BM Unit's time to be Synchronised arising as a direct consequence of the inherent design or operational practice of the Power Station and/or BM Unit, e.g. limited barring facilities, time from a Total Shutdown or Partial Shutdown at which batteries would be discharged.</p>		<p>Text</p>	<p>DPD II</p>
<p>Block Loading Capability:</p>		<p>—</p>	<p>—</p>
<p>c) Provide estimated Block Loading Capability from OMV to Registered Capacity of each BM Unit based on the unit being 'hot' (run prior to shutdown) and also 'cold' (not run for 48hrs or more prior to the shutdown). The Block Loading Capability should be valid for a frequency deviation of 49.5Hz – 50.5Hz. The data should identify any required 'hold' points.</p>		<p>Tabular or Graphical</p>	<p>DPD II</p>

Formatted: Highlight

Formatted: Highlight

Formatted: Highlight

Formatted: Highlight

SCHEDULE 17 - ACCESS PERIOD DATA

PAGE 1 OF 1

(PC.A.4 - CUSC Contract ■)

Submissions by Users using this Schedule 17 shall commence in 2011 and shall then continue in each year thereafter

Access Group

Asset Identifier	Start Week	End Week	Maintenance Year (1, 2 or 3)	Duration	Potential Concurrent Outage (Y/N)

Comments

- Formatted: Highlight
- Formatted: Highlight
- Formatted: Highlight
- Formatted: Highlight
- Formatted: Highlight

SCHEDULE 18 - OFFSHORE TRANSMISSION SYSTEM DATA

PAGE 1 OF 24

The data in this Schedule 18 is required from **Generators** who are undertaking **OTSDUW** and connecting to a **Transmission Interface Point**.

- Formatted: Highlight
- Formatted: Highlight
- Formatted: Highlight
- Formatted: Highlight

DATA DESCRIPTION	UNITS	DATA to		DATA CAT.	GENERATING UNIT OR STATION DATA							
		RTL			F.Yr0	F.Yr1	F.Yr2	F.Yr3	F.Yr4	F.Yr5	F.Yr6	
		CUSC Cont fact	CUSC App. Form									
INDIVIDUAL OTSDUW DATA												
Interface Point Capacity (PC.A.3.2.2 (a))	MW MVA _r	<input type="checkbox"/>	<input checked="" type="checkbox"/>									
Performance Chart at the Transmission Interface Point for OTSDUW Plant and Apparatus (PC.A.3.2.2(f)(iv))		<input type="checkbox"/>	<input checked="" type="checkbox"/>									
OTSDUW DEMANDS												
Demand associated with the OTSDUW Plant and Apparatus (excluding OTSDUW DC Converters – see Note 1)) supplied at each Interface Point. The User should also provide the Demand supplied to each Connection Point on the OTSDUW Plant and Apparatus. (PC.A.5.2.5)												
- The maximum Demand that could occur.	MW MVA _r	<input type="checkbox"/>	<input type="checkbox"/>	DPD I								
- Demand at specified time of annual peak half hour of National Electricity Transmission System Demand at Annual ACS Conditions.	MW MVA _r	<input type="checkbox"/>	<input type="checkbox"/>	DPD I DPD II								
- Demand at specified time of annual minimum half-hour of National Electricity Transmission System Demand.	MW MVA _r	<input type="checkbox"/>	<input type="checkbox"/>	DPD II DPD II								
(Note 1 – Demand required from OTSDUW DC Converters should be supplied under page 2 of Schedule 18).												

SCHEDULE 18 - OFFSHORE TRANSMISSION SYSTEM DATA

PAGE 2 OF 24

OTSDUW USERS SYSTEM DATA

DATA DESCRIPTION	UNITS	DATA to RTL		DATA CATEGORY
		CUSC Contract	CUSC App. Form	
OFFSHORE TRANSMISSION SYSTEM LAYOUT <i>(P.C.A.2.2.1, P.C.A.2.2.2 and P.C.A.2.2.3)</i>				
A Single Line Diagram showing connectivity of all of the Offshore Transmission System including all Plant and Apparatus between the Interface Point and all Connection Points is required.		■	■	SPD
This Single Line Diagram shall depict the arrangement(s) of all of the existing and proposed load current carrying Apparatus relating to both existing and proposed Interface Points and Connection Points , showing electrical circuitry (ie. overhead lines, underground cables (including subsea cables), power transformers and similar equipment), operating voltages, circuit breakers and phasing arrangements		■	■	SPD
Operational Diagrams of all substations within the OTSDUW Plant and Apparatus		■	■	SPD
SUBSTATION INFRASTRUCTURE <i>(P.C.A.2.2.6)</i>				
For the infrastructure associated with any OTSDUW Plant and Apparatus				
Rated 3-phase rms short-circuit withstand current	kA	■	■	SPD
Rated 1-phase rms short-circuit withstand current	kA	■	■	SPD
Rated Duration of short-circuit withstand	s	■	■	SPD
Rated rms continuous current	A	■	■	SPD
LUMPED SUSCEPTANCES <i>(P.C.A.2.3)</i>				
Equivalent Lumped Susceptance required for all parts of the User's Subtransmission System (including OTSDUW Plant and Apparatus) which are not included in the Single Line Diagram.		■	■	
This should not include:		■	■	
(a) independently switched reactive compensation equipment identified above.		■	■	
(b) any susceptance of the OTSDUW Plant and Apparatus inherent in the Demand (Reactive Power) data provided on Page 1 and 2 of this Schedule 14.		■	■	
Equivalent lumped shunt susceptance at nominal Frequency .	% on 100 MVA	■	■	

Formatted: Highlight

SCHEDULE 18 - OFFSHORE TRANSMISSION SYSTEM DATA

OFFSHORE TRANSMISSION SYSTEM DATA

Branch Data (PC-A.2.2.4)

Node 1	Node 2	Rated Voltage (kV)	Operating Voltage (kV)	Circuit	PPS PARAMETERS				ZPS PARAMETERS				Maximum Continuous Ratings			Length (km)	
					R1 %100 MVA	X1 %100 MVA	B.1 %100 MVA	R0 %100 MVA	X0 %100M VA	B0 %100M VA	Winter (MVA)	Spring Autumn (MVA)	Summer (MVA)				

Notes

1. For information equivalent STC Reference: STCP12-1m Part 3 –2.1 Branch Data
2. In the case where an overhead line exists within the OTSDUW Plant and Apparatus the Mutual inductances should also be provided.

SCHEDULE 18 - OFFSHORE TRANSMISSION SYSTEM DATA
PAGE 4 OF 24

OFFSHORE TRANSMISSION SYSTEM DATA

2 Winding Transformers Data (PC.A.2.2.5)

The data below is **Standard Planning Data**, and details should be shown below of all transformers shown on the **Single Line Diagram**

HV Node (kV)	LV Node (kV)	Rating (MVA)	Transformer	Positive Phase Sequence Reactance % on 100MVA			Positive Phase Sequence Resistance % on 100 MVA			Tap Changer			Winding Arr.	Earthing Method (Direct /Res /Reac)	Earthing Impedance method		
				Max Tap	Min Tap	Nom Tap	Max Tap	Min Tap	Nom Tap	Range +-% to -%	Step size %	Type					

Notes

1 For information the corresponding STC Reference is STCP12-1: Part 3 – 2.4 Transformers

Formatted: Highlight

Formatted: Highlight

EXISTING USERS SYSTEM DATA (OTSUA)

Auto Transformer Data 3-Winding (PC.A.2.2.5)

The data below is all Standard Planning Data, and details should be shown below of all transformers shown on the Single Line Diagram:

SCHEDULE 18 - OFFSHORE TRANSMISSION SYSTEM DATA

PAGE 5 OF 24

HV NODE	V _H (kV)	LV NODE	V _L (kV)	PSS/E Circuit	Rating (MVA)	Transformer	Positive Phase Sequence Reactance % on 100MVA			Positive Phase Sequence Resistance % on 100MVA			Taps Range +/- % to - %	Step size % Winding Type (onload Arrangement	Earthing Impedance Method	EQUIVALENT ZPS PARAMETERS (FLIP)						NGT Sheet	NGC Code					
							Max		Min		Norm					ZOH		ZOL		ZOT								
							Tap	Tap	Tap	Tap	Tap	Tap				Rot % 100 MVA	X _{oh} % 100 MVA	Rot % 100 MVA	X _{ol} % 100 MVA	Rot % 100 MVA	X _{ot} % 100 MVA			D _{flr} X/R =20				
---	---	---	---	---	---	---	---	---	---	---	---	---	---	---	---	---	---	---	---	---	---	---	---	---	---	---	---	
---	---	---	---	---	---	---	---	---	---	---	---	---	---	---	---	---	---	---	---	---	---	---	---	---	---	---	---	---
---	---	---	---	---	---	---	---	---	---	---	---	---	---	---	---	---	---	---	---	---	---	---	---	---	---	---	---	---

Notes

1. For information STC Reference: STCP12-1 : Part 3 - 2.4 Transformers

Formatted: Highlight

SCHEDULE 18 - OFFSHORE TRANSMISSION SYSTEM DATA

PAGE 6 OF 24

OFFSHORE TRANSMISSION SYSTEM DATA

Circuit Breaker Data (PC.A.2.2.6(a))

The data below is all **Standard Planning Data**, and should be provided for all **OTSUA** switchgear (i.e. circuit breakers, load disconnectors and disconnectors)

Location	Circuit Breaker Data						Assumed Operating Times				3 Phase					1 Phase						
	Name	Rated Voltage	Operating Voltage	Make	Model	Type	Year Commissioned	Circuit Breaker (ms)	Minimum Protection & Trip Relay (ms)	Total Time (ms)	Conductance Rating (A)	Fault Rating (RMS Symmetrical) (3 phase) (kA) (MVA)	Fault Break Rating (Peak Asymmetrical) (3 phase) (kA)	Fault Make Rating (Peak Asymmetrical) (3 phase) (kA)	Fault Rating (RMS Symmetrical) (1 phase) (kA) (MVA)	Fault Break Rating (Peak Asymmetrical) (1 phase) (kA)	Fault Break Rating (RMS Symmetrical) (1 phase) (kA)	Fault Make Rating (Peak Asymmetrical) (1 phase) (kA)	Fault Break Rating (Peak Asymmetrical) (1 phase) (kA)	Fault Make Rating (Peak Asymmetrical) (1 phase) (kA)	DC Time constant at testing of asymmetrical breaking ability (s)	
-	-	-	-	-	-	-	-	-	-	-	-	-	-	-	-	-	-	-	-	-	-	-
-	-	-	-	-	-	-	-	-	-	-	-	-	-	-	-	-	-	-	-	-	-	-

SCHEDULE 18 - OFFSHORE TRANSMISSION SYSTEM DATA

OFFSHORE TRANSMISSION SYSTEM DATA

REACTIVE COMPENSATION EQUIPMENT (PC.A.2.4(e))

Item	Node	kV	Device No.	Rating (MVar)	P Loss (kW)	Tap range	Connection Arrangement

Notes:

1. For information STC Reference: STCP12-1: Part 3 - 2.5 Reactive Compensation Equipment
2. Data relating to continuously variable reactive compensation equipment (such as statcoms or SVCs) should be entered on the SVC Modelling table.
3. For the avoidance of doubt this includes any AC Reactive Compensation equipment included within the OTSDUW DC Converter other than harmonic filter data which is to be entered in the harmonic filter data table.

PC.A.2.4.1(e)	A mathematical representation in block diagram format to model the control of any dynamic compensation plant. The model should be suitable for RMS dynamic stability type studies in which the time constants used should not be less than 10ms.
----------------------	--

SCHEDULE 18 - OFFSHORE TRANSMISSION SYSTEM DATA
PAGE 8 OF 24

OFFSHORE TRANSMISSION SYSTEM DATA
 REACTIVE COMPENSATION - SVC Modelling Data (PC.A.2.4.1(e)(iii))

HV Node	LV Node	Control Node	Normal Voltage (kV)	Target Voltage (kV)	Max MVA/ at HV	Min MVA/ at HV	Slope %	Voltage Dependant Q Limit	Normal Running Mode	R1 PPS_R	X1 PPS_X	R0 ZPS_R	X0 ZPS_X	Transf Winding Type	Connection (Direct/Tertiary)

Notes:

1. For information the equivalent STC Reference is: STCP12-1: Part 3 - 2.7. SVC Modelling Data

Formatted: Highlight

SCHEDULE 18 - OFFSHORE TRANSMISSION SYSTEM DATA

PAGE 9 OF 24

OFFSHORE TRANSMISSION SYSTEM DATA

Harmonic Filter Data (including OTSDUW DC Converter harmonic Filter Data)
(PC.A.5.4.3.1(d) and PC.A.6.4.2)

Site Name	SLD Reference	Point of Filter Connection		
Filter Description				
Manufacturer	Model	Filter Type	Filter connection type (Delta/Star, Grounded/ Ungrounded)	Notes
Bus Voltage	Rating	Q factor	Tuning Frequency	Notes
Component Parameters (as per SLD)				
Parameter as applicable				
Filter Component (R, C or L)	Capacitance (micro-Farads)	Inductance (milli-Henrys)	Resistance (Ohms)	Notes
Filter frequency characteristics (graphs) detailing for frequency range up to 10kHz and higher				
1. Graph of impedance (ohm) against frequency (Hz) 2. Graph of angle (degree) against frequency (Hz) 3. Connection diagram of Filter & Elements				

Formatted: Highlight

- Notes:**
1. For information STC Reference: STCP12-1: Part 3 - 2.8 Harmonic Filter Data

SCHEDULE 18 - OFFSHORE TRANSMISSION SYSTEM DATA

PAGE 10 OF 24

Information for Transient Overvoltage Assessment (DPD I) (PC.A.6.2 ■ CUSC Contract)

The information listed below may be requested by NGET from each User undertaking OTSDUW with respect to any Interface Point or Connection Point to enable NGET to assess transient overvoltage on the National Electricity Transmission System.

- (a) Busbar layout plan(s), including dimensions and geometry showing positioning of any current and voltage transformers, through bushings, support insulators, disconnectors, circuit breakers, surge arresters, etc. Electrical parameters of any associated current and voltage transformers, stray capacitances of wall bushings and support insulators, and grading capacitances of circuit breakers;
- (b) Electrical parameters and physical construction details of lines and cables connected at that busbar. Electrical parameters of all plant e.g., transformers (including neutral earthing impedance or zig-zag transformers if any), series reactors and shunt compensation equipment connected at that busbar (or to the tertiary of a transformer) or by lines or cables to that busbar;
- (c) Basic insulation levels (BIL) of all Apparatus connected directly, by lines or by cables to the busbar;
- (d) Characteristics of overvoltage Protection devices at the busbar and at the termination points of all lines, and all cables connected to the busbar;
- (e) Fault levels at the lower voltage terminals of each transformer connected to each Interface Point or Connection Point without intermediate transformation;
- (f) The following data is required on all transformers within the OTSDUW Plant and Apparatus.
- (g) An indication of which items of equipment may be out of service simultaneously during Planned Outage conditions.

Harmonic Studies (DPD I) (PC.A.6.4 ■ CUSC Contract)

The information given below, both current and forecast, where not already supplied in this Schedule 18 may be requested by NGET from each User if it is necessary for NGET to evaluate the production/magnification of harmonic distortion on National Electricity Transmission System. The impact of any third party Embedded within the User's System should be reflected:-

- (a) Overhead lines and underground cable circuits (including subsea cables) of the User's OTSDUW Plant and Apparatus must be differentiated and the following data provided separately for each type:-
 - Positive phase sequence resistance
 - Positive phase sequence reactance
 - Positive phase sequence susceptance
- (b) for all transformers connecting the OTSDUW Plant and Apparatus to a lower voltage:-
 - Rated MVA
 - Voltage Ratio
 - Positive phase sequence resistance
 - Positive phase sequence reactance

SCHEDULE 18 - OFFSHORE TRANSMISSION SYSTEM DATA

PAGE 11 OF 24

(c) at the lower voltage points of those connecting transformers:-

Equivalent positive phase sequence susceptance

Connection voltage and MVA rating of any capacitor bank and component design parameters if configured as a filter

Equivalent positive phase sequence interconnection impedance with other lower voltage points

The minimum and maximum Demand (both MW and MVA) that could occur

Harmonic current injection sources in Amps at the Connection Points and Interface Points

(d) an indication of which items of equipment may be out of service simultaneously during Planned Outage conditions

Voltage Assessment Studies (DPD I) (PC.A.6.5 ■ CUSC Contract)

The information listed below, where not already supplied in this Schedule 14, may be requested by NGET from each User undertaking OTSDUW with respect to any Connection Point or Interface Point if it is necessary for NGET to undertake detailed voltage assessment studies (eg to examine potential voltage instability, voltage control co-ordination or to calculate voltage step changes on the National Electricity Transmission System).

(a) For all circuits of the User's OTSDUW Plant and Apparatus:-

Positive Phase Sequence Reactance

Positive Phase Sequence Resistance

Positive Phase Sequence Susceptance

MVA rating of any reactive compensation equipment

(b) for all transformers connecting the User's OTSDUW Plant and Apparatus to a lower voltage:-

Rated MVA

Voltage Ratio

Positive phase sequence resistance

Positive Phase sequence reactance

Tap-changer range

Number of tap steps

Tap-changer type: on-load or off-circuit

AVC/tap-changer time delay to first tap movement

AVC/tap-changer inter-tap time delay

(c) at the lower voltage points of those connecting transformers

Equivalent positive phase sequence susceptance

MVA rating of any reactive compensation equipment

Equivalent positive phase sequence interconnection impedance with other lower voltage points

The maximum Demand (both MW and MVA) that could occur

Estimate of voltage insensitive (constant power) load content in % of total load at both winter peak and 75% off-peak load conditions

SCHEDULE 18 - OFFSHORE TRANSMISSION SYSTEM DATA

PAGE 12 OF 24

Short Circuit Analyses: (DPD I) (PC.A.6.6 ■ CUSC Contract)

The information listed below, both current and forecast, and where not already supplied under this Schedule 14, may be requested by NGET from each User undertaking OTSDUW with respect to any Connection Point or Interface Point where prospective short-circuit currents on equipment owned by a Transmission Licensee or operated or managed by NGET are close to the equipment rating.

(a) For all circuits of the User's OTSDUW Plant and Apparatus:-

Positive phase sequence resistance
Positive phase sequence reactance
Positive phase sequence susceptance
Zero phase sequence resistance (both self and mutuals)
Zero phase sequence reactance (both self and mutuals)
Zero phase sequence susceptance (both self and mutuals)

(b) for all transformers connecting the User's OTSDUW Plant and Apparatus to a lower voltage:-

Rated MVA
Voltage Ratio
Positive phase sequence resistance (at max, min and nominal tap)
Positive Phase sequence reactance (at max, min and nominal tap)
Zero phase sequence reactance (at nominal tap)
Tap changer range
Earthing method: direct, resistance or reactance
Impedance if not directly earthed

(c) at the lower voltage points of those connecting transformers:-

The maximum Demand (in MW and MVA_r) that could occur
Short-circuit infeed data in accordance with PC.A.2.5.6(a) unless the User's OTSDUW Plant and Apparatus runs in parallel with the Subtransmission System, when to prevent double counting in each node infeed data, a π equivalent comprising the data items of PC.A.2.5.6(a) for each node together with the positive phase sequence interconnection impedance between the nodes shall be submitted.

Formatted: Highlight

Formatted: Highlight

SCHEDULE 18 - OFFSHORE TRANSMISSION SYSTEM DATA

DATA DESCRIPTION	UNITS	F.	F.	F.	F.	F.	F.	F.	F.	DATA to RTL	
		Yr. 0	Yr. 1	Yr. 2	Yr. 3	Yr. 4	Yr. 5	Yr. 6	Yr. 7		
										CUSC Contract	CUSC App. Form
- A continuous time trace and table showing the root mean square of the positive, negative and zero sequence components of the fault current from the time of fault inception to 140ms after fault inception at 10ms intervals	Graphical and tabular kA versus s									<input type="checkbox"/>	<input checked="" type="checkbox"/>
- A continuous time trace and table showing the positive, negative and zero sequence components of retained voltage at the Interface Point and each Connection Point, if appropriate	p.u. versus s									<input type="checkbox"/>	<input checked="" type="checkbox"/>
- A continuous time trace and table showing the root mean square of the positive, negative and zero sequence components of retained voltage at the fault point, if appropriate	p.u. versus s									<input type="checkbox"/>	<input checked="" type="checkbox"/>
Positive sequence X/R ratio of the equivalent at time of fault at the Interface Point and each Connection Point										<input type="checkbox"/>	<input checked="" type="checkbox"/>
Minimum zero sequence impedance of the equivalent at the Interface Point and each Connection Point										<input type="checkbox"/>	<input checked="" type="checkbox"/>
Active Power transfer at the Interface Point and each Connection Point pre-fault	MW									<input type="checkbox"/>	<input checked="" type="checkbox"/>
Power Factor (lead or lag)										<input type="checkbox"/>	<input checked="" type="checkbox"/>
Pre-fault voltage (if different from 1.0 p.u.) at fault point (See note 1)	p.u.									<input type="checkbox"/>	<input checked="" type="checkbox"/>
Items of reactive compensation switched in pre-fault										<input type="checkbox"/>	<input checked="" type="checkbox"/>

Formatted: Highlight

Note 1. The pre-fault voltage provided above should represent the voltage within the range 0.95 to 1.05 that gives the highest fault current

SCHEDULE 18 - OFFSHORE TRANSMISSION SYSTEM DATA

PAGE 15 OF 24

Thermal Ratings Data (PC.A.2.2.4)

CIRCUIT RATING SCHEDULE

Voltage 132kV	Offshore TO Name	Issue Date

CIRCUIT Name from Site A – Site B

OVERALL CCT RATINGS	Winter				Spring/Autumn				Summer				
	%Nom	Limit	Amps	MVA	%Nom	Limit	Amps	MVA	%Nom	Limit	Amps	MVA	
Pre-Fault Continuous	84%	Line	485	111	84%	Line	450	103	84%	Line	390	89	
Post-Fault Continuous	100%	Line	580	132	100%	Line	540	123	100%	Line	465	106	
Prefault load exceeds line prefault continuous rating	6hr	95%	Line	580	132	95%	Line	540	123	95%	Line	465	106
	20m		Line	580	132		Line	540	123		Line	465	106
	10m	mva	Line	580	132	mva	Line	540	123	mva	Line	465	106
	5m	125	Line	580	132	116	Line	540	123	100	Line	465	106
Short Term Overloads	6hr	90%	Line	580	132	90%	Line	540	123	90%	Line	465	106
	20m		Line	580	132		Line	540	123		Line	465	106
	10m	mva	Line	580	132	mva	Line	540	123	mva	Line	465	106
	5m	118	Line	580	132	110	Line	540	123	95	Line	465	106
Limiting Item and permitted overload values for different times and pre-fault loads	6hr	84%	Line	580	132	84%	Line	540	123	84%	Line	465	106
	20m		Line	590	135		Line	545	125		Line	470	108
	10m	mva	Line	630	144	mva	Line	580	133	mva	Line	495	113
	5m	110	Line	710	163	103	Line	655	149	89	Line	555	126
6hr	75%	Line	580	132	75%	Line	540	123	75%	Line	465	106	
		Line	595	136		Line	555	126		Line	475	109	
	mva	Line	650	149	mva	Line	600	137	mva	Line	510	116	
	99	Line	760	173	92	Line	695	159	79	Line	585	134	
20m	60%	Line	580	132	60%	Line	540	123	60%	Line	465	106	
		Line	605	138		Line	560	128		Line	480	110	
	mva	Line	675	155	mva	Line	620	142	mva	Line	530	121	
	79	Line	820	187	73	Line	750	172	63	Line	635	145	
5m	30%	Line	580	132	30%	Line	540	123	30%	Line	465	106	
		Line	615	141		Line	570	130		Line	490	112	
	mva	Line	710	163	mva	Line	655	150	mva	Line	555	127	
	39	Line	895	205	36	Line	820	187	31	Line	690	158	
3m		Line	1110	255		Line	1010	230		Line	845	193	

SCHEDULE 18 - OFFSHORE TRANSMISSION SYSTEM DATA

PAGE 16 OF 24

Notes or Restrictions Detailed	6hr																				
	20m																				
	10m																				
	5m																				
	3m																				
	6hr																				
	20m																				
	10m																				
5m																					
3m																					

Notes: 1. For information the equivalent STC Reference: STCP12-1: Part 3 - 2.6 Thermal Ratings
2. The values shown in the above table is example data.

SCHEDULE 18 - OFFSHORE TRANSMISSION SYSTEM DATA

PAGE 17 OF 24

Protection Policy (PC.A.6.3)

To include details of the protection policy

Protection Schedules (PC.A.6.3)

Data schedules for the protection systems associated with each primary plant item including:

Protection, Intertrip Signalling & operating times

Intertripping and protection unstabilisation initiation

Synchronising facilities

Delayed Auto Reclose sequence schedules

Automatic Switching Scheme Schedules (PC.A.2.2.7)

A diagram of the scheme and an explanation of how the system will operate and what plant will be affected by the scheme's operation.

SCHEDULE 18 - OFFSHORE TRANSMISSION SYSTEM DATA

PAGE 18 OF 24

GENERATOR INTERTRIP SCHEMES (PC.A.2.2.7(b))

Substation: _____

Details of Generator Intertrip Schemes:

A diagram of the scheme and an explanation of how the system will operate and what plant will be effected by the schemes operation.

DEMAND INTERTRIP SCHEMES (PC.A.2.2.7(b))

Substation: _____

Details of Demand Intertrip Schemes:

A diagram of the scheme and an explanation of how the system will operate and what plant will be effected by the schemes operation

SCHEDULE 18 - OFFSHORE TRANSMISSION SYSTEM DATA

PAGE 19 OF 24

Specific Operating Requirements (CC.5.2.1)

SUBSTATION OPERATIONAL GUIDE

Substation: _____

Location Details:

Postal Address:	Telephone Nos.	Map Ref.
National Grid Interface		
Generator Interface		

- 1. Substation Type:**
- 2. Voltage Control:** *(short description of voltage control system. To include mention of modes ie Voltage, manual etc. Plus control step increments ie 0.5%-0.33kV?)*
- 3. Energisation Switching Information:** *(The standard energisation switching process from dead.)*
- 4. Intertrip Systems:**
- 5. Reactive Plant Outage:** *(A short explanation of any system re-configurations required to facilitate the outage of any reactive plant which form part of the OTSDUW Plant and Apparatus equipment. Also any generation restrictions required).*
- 6. Harmonic Filter Outage:** *(An explanation as to any OTSDUW Plant and Apparatus reconfigurations required to facilitate the outage and maintain the system within specified Harmonic limits, also any generation restrictions required).*

SCHEDULE 18 - OFFSHORE TRANSMISSION SYSTEM DATA

PAGE 20 OF 24

OTSDUW DC CONVERTER TECHNICAL DATA

OTSDUW DC CONVERTER NAME _____ **DATE:** _____

Data Description	Units	DATA to		Data Category	DC Converter Station Data
		RTL			
(PC.A.4 and PC.A.5.2.5)		<small>CUSC Contract</small>	<small>CUSC Appl. Form</small>		
OTSDUW DC CONVERTER (CONVERTER DEMANDS):					
Demand supplied through Station Transformers associated with the OTSDUW DC Converter at each Interface Point and each Offshore Connection Point Grid Entry Point [PC.A.4.1]					
- Demand with all OTSDUW DC Converters operating at Interface Point Capacity.	MW MVA _r	<input type="checkbox"/>	<input type="checkbox"/>	DPD II DPD II	
- Demand with all OTSDUW DC Converters operating at maximum Interface Point flow from the Interface Point to each Offshore Grid Entry Point	MW MVA _r	<input type="checkbox"/>	<input type="checkbox"/>	DPD II DPD II	
- The maximum Demand that could occur.	MW MVA _r	<input type="checkbox"/>	<input type="checkbox"/>	DPD II DPD II	
- Demand at specified time of annual peak half hour of NGET Demand at Annual ACS Conditions.	MW MVA _r	<input type="checkbox"/>	<input type="checkbox"/>	DPD II DPD II	
- Demand at specified time of annual minimum half-hour of NGET Demand.	MW MVA _r	<input type="checkbox"/>	<input type="checkbox"/>	DPD II	
OTSDUW DC CONVERTER DATA	Text	<input type="checkbox"/>	<input type="checkbox"/>	SPD+	
Number of poles, i.e. number of OTSDUW DC Converters	Text	<input type="checkbox"/>	<input type="checkbox"/>	SPD+	
Pole arrangement (e.g. monopole or bipole)	Diagram	<input type="checkbox"/>			
Return path arrangement					
Details of each viable operating configuration					
Configuration 1	Diagram	<input type="checkbox"/>	<input type="checkbox"/>	SPD+	
Configuration 2	Diagram	<input type="checkbox"/>	<input type="checkbox"/>		
Configuration 3	Diagram	<input type="checkbox"/>	<input type="checkbox"/>		
Configuration 4	Diagram	<input type="checkbox"/>	<input type="checkbox"/>		
Configuration 5	Diagram	<input type="checkbox"/>	<input type="checkbox"/>		
Configuration 6	Diagram	<input type="checkbox"/>	<input type="checkbox"/>		

SCHEDULE 18 - OFFSHORE TRANSMISSION SYSTEM DATA

PAGE 21 OF 24

Data Description	Units	DATA to		Data Category	Operating Configuration					
		CUSC Contract	RTL CUSC App. Form		1	2	3	4	5	6
OTSDUW DC CONVERTER DATA (PC.A.3.3.1(d))										
OTSDUW DC Converter Type (e.g. current or Voltage source)	Text	<input type="checkbox"/>	<input type="checkbox"/>	SPD						
If the busbars at the Interface Point or Connection Point are normally run in separate sections identify the section to which the OTSDUW DC Converter configuration is connected	Section Number	<input type="checkbox"/>	<input type="checkbox"/>	SPD						
Rated MW import per pole (PC.A.3.3.1)	MW	<input type="checkbox"/>	<input type="checkbox"/>	SPD+						
Rated MW export per pole (PC.A.3.3.1)	MW	<input type="checkbox"/>	<input type="checkbox"/>	SPD+						
ACTIVE POWER TRANSFER CAPABILITY (PC.A.3.2.2)										
Interface Point Capacity	MW MVA _r	<input type="checkbox"/> <input type="checkbox"/>	<input type="checkbox"/> <input type="checkbox"/>	SPD SPD						
OTSDUW DC CONVERTER TRANSFORMER (PC.A.5.4.3.1)										
Rated MVA	MVA	<input type="checkbox"/>	<input type="checkbox"/>	DPD II						
Winding arrangement		<input type="checkbox"/>	<input type="checkbox"/>							
Nominal primary voltage	kV	<input type="checkbox"/>	<input type="checkbox"/>	DPD II						
Nominal secondary (converter-side) voltage(s)	kV	<input type="checkbox"/>	<input type="checkbox"/>	DPD II						
Positive sequence reactance		<input type="checkbox"/>	<input type="checkbox"/>							
Maximum tap	% on	<input type="checkbox"/>	<input type="checkbox"/>	DPD II						
Nominal tap	MVA	<input type="checkbox"/>	<input type="checkbox"/>	DPD II						
Minimum tap	% on	<input type="checkbox"/>	<input type="checkbox"/>	DPD II						
Positive sequence resistance	MVA	<input type="checkbox"/>	<input type="checkbox"/>	DPD II						
Maximum tap	% on	<input type="checkbox"/>	<input type="checkbox"/>	DPD II						
Nominal tap	MVA	<input type="checkbox"/>	<input type="checkbox"/>	DPD II						
Minimum tap	% on	<input type="checkbox"/>	<input type="checkbox"/>	DPD II						
Zero phase sequence reactance	% on	<input type="checkbox"/>	<input type="checkbox"/>	DPD II						
Tap change range	MVA	<input type="checkbox"/>	<input type="checkbox"/>	DPD II						
Number of steps	% on	<input type="checkbox"/>	<input type="checkbox"/>	DPD II						
	MVA	<input type="checkbox"/>	<input type="checkbox"/>	DPD II						
	% on	<input type="checkbox"/>	<input type="checkbox"/>							
	MVA	<input type="checkbox"/>	<input type="checkbox"/>							
	% on	<input type="checkbox"/>	<input type="checkbox"/>							
	MVA	<input type="checkbox"/>	<input type="checkbox"/>							
	+% / -%	<input type="checkbox"/>	<input type="checkbox"/>							

SCHEDULE 18 - OFFSHORE TRANSMISSION SYSTEM DATA

PAGE 22 OF 24

Data Description	Units	DATA to RTL		Data Category	Operating configuration						
		CUSC Contract	CUSC Appl. Form		1	2	3	4	5	6	
OTSDUW DC CONVERTER NETWORK DATA (PC.A.5.4.3.1 (c)) Rated DC voltage per pole Rated DC current per pole Details of the OTSDUW DC Network described in diagram form including resistance, inductance and capacitance of all DC cables and/or DC lines. Details of any line reactors (including line reactor resistance), line capacitors, DC filters, earthing electrodes and other conductors that form part of the OTSDUW DC Network should be shown.	kV A Diagram	[] []		DPD II DPD II DPD II							

SCHEDULE 18 - OFFSHORE TRANSMISSION SYSTEM DATA

Data Description	Units	DATA to		Data Category	Operating configuration					
		RTL			1	2	3	4	5	6
		CUSC Contract	CUSC App. Form							
OTSDUW DC CONVERTER CONTROL SYSTEMS (PC.A.5.4.3.2)										
Static $V_{DC} - P_{DC}$ (DC voltage – DC power) or Static $V_{DC} - I_{DC}$ (DC voltage – DC current) characteristic (as appropriate) when operating as –Rectifier –Inverter	Diagram	□		DPD II						
	Diagram	□		DPD II						
Details of rectifier mode control system, in block diagram form together with parameters showing transfer functions of individual elements.	Diagram	□		DPD II						
	Diagram	□		DPD II						
Details of inverter mode control system, in block diagram form showing transfer functions of individual elements including parameters (as applicable).	Diagram	□		DPD II						
	Diagram	□		DPD II						
Details of OTSDUW DC Converter transformer tap changer control system in block diagram form showing transfer functions of individual elements including parameters.	Diagram	□		DPD II						
	Diagram	□		DPD II						
Details of AC filter control systems in block diagram form showing transfer functions of individual elements including parameters	Diagram	□		DPD II						
	Diagram	□		DPD II						
Details of any frequency and/or load control systems in block diagram form showing transfer functions of individual elements including parameters.	Diagram	□		DPD II						
	Diagram	□		DPD II						
Details of any large or small signal modulating controls, such as power oscillation damping controls or sub- synchronous oscillation damping controls, that have not been submitted as part of the above control system data.	Diagram	□		DPD II						
	Diagram	□		DPD II						
Transfer block diagram representation of the reactive power control at converter ends for a voltage source converter.	Diagram	□		DPD II						

SCHEDULE 18 - OFFSHORE TRANSMISSION SYSTEM DATA
PAGE 24 OF 24

Data Description	Units	DATA to		Data Category	Operating configuration					
		CUSC Contract	CUSC App. Form		1	2	3	4	5	6
LOADING PARAMETERS (PC.A.5.4.3.3)										
MW Export from the Offshore Grid Entry Point to the Transmission Interface Point Nominal loading rate Maximum (emergency) loading rate	MW/s			DPD I DPD I						
	MW/s									
Maximum recovery time, to 90% of pre-fault loading, following an AC system fault or severe voltage depression.	s			DPD II						
Maximum recovery time, to 90% of pre-fault loading, following a transient DC Network fault.	s			DPD II						

SCHEDULE 19 – EXISTING-USER DATA FILE STRUCTURE

PAGE 1 OF 2

The structure of the **User Data File Structure** is given below.

i.d.	Folder name	Description of contents
Part A: Commercial & Legal		
A2	Commissioning	Commissioning & Test Programmes
A3	Statements	Statements of Readiness
A9	AS Monitoring	Ancillary Services Monitoring
A10	Self Certification	User Self Certification of Compliance
A11	Compliance statements	Compliance Statement
Part 1: Safety & System Operation		
1.1	Interface Agreements	Interface Agreements
1.2	Safety Rules	Safety Rules
1.3	Switching Procedures	Local Switching Procedures
1.4	Earthing	Earthing
1.5	SRS	Site Responsibility Schedules
1.6	Diagrams	Operational and Gas Zone Diagrams
1.7	Drawings	Site Common Drawings
1.8	Telephony	Control Telephony
1.9	Safety Procedures	Local Safety Procedures
1.10	Co-ordinators	Safety Co-ordinators
1.11	RISSP	Record of Inter System Safety Precautions
1.12	Tel Numbers	Telephone Numbers for Joint System Incidents
1.13	Contact Details	Contact Details (fax, tel, email)
1.14	Restoration Plan	Local Joint Restoration Plan (incl. black start if applicable)
1.15	Maintenance	Maintenance Standards
Part 2: Connection Technical Data		
2.1	DRC Schedule 5	DRC Schedule 5 – Users System Data
2.2	Protection Report	Protection Settings Reports
2.3	Special Automatic Facilities	Special Automatic Facilities e.g. intertrip
2.4	Operational Metering	Operational Metering
2.5	Tariff Metering	Tariff Metering
2.6	Operational Comms	Operational Communications
2.7	Monitoring	Performance Monitoring
2.8	Power Quality	Power Quality Test Results (if required)

SCHEDULE 19 – EXISTING USER DATA FILE STRUCTURE

PAGE 2 OF 2

Part 3: Generator Technical Data		
3.1	DRC Schedule 1	DRC Schedule 1 - Generating Unit, Power Generating Module, HVDC System and DC Converter Technical Data
3.2	DRC Schedule 2	DRC Schedule 2 - Generation Planning Data
3.3	DRC Schedule 4	DRC Schedule 4 – Frequency Droop & Response
3.4	DRC Schedule 14	DRC Schedule 14 – Fault Infeed Data – Generators
3.5	Special Generator Protection	Special Generator Protection eg Pole slipping; islanding
3.6	Compliance Tests	Compliance Tests & Evidence
3.7	Compliance Studies	Compliance Simulation Studies
3.8	Site Specific	Bilateral Connections Agreement Technical Data & Compliance
Part 4: General DRC Schedules		
4.1	DRC Schedule 3	DRC Schedule 3 – Large Power Station Outage Information
4.2	DRC Schedule 6	DRC Schedule 6 – Users Outage Information
4.3	DRC Schedule 7	DRC Schedule 7 – Load Characteristics
4.4	DRC Schedule 8	DRC Schedule 8 – BM Unit Data (if applicable)
4.5	DRC Schedule 10	DRC Schedule 10 –Demand Profiles
4.6	DRC Schedule 11	DRC Schedule 11 – Connection Point Data
Part 5: OTSDUW Data And Information (if applicable and prior to OTSUA Transfer Time)		
		Diagrams Circuits Plant and Apparatus Circuit Parameters Protection Operation and Autoswitching Automatic Control Systems
		Mathematical model of dynamic compensation plant

< END OF DATA REGISTRATION CODE >

GC0104 DRAFT EUROPEAN CONNECTION CONDITIONS LEGAL TEXT

DATED 24/0418

Key

- 1) Blue Highlighted Text – Taken from GC012 Code Administrator Consultation dated 12/01/2018 - Not relevant for DCC
- 2) Black – Relevant text for GC0104
- 3) Track change marked text – relevant changes for GC0104

Formatted: Font color: Auto, Highlight

Formatted: Font color: Auto, Highlight

**EUROPEAN CONNECTION CONDITIONS
(ECC)**

CONTENTS

(This contents page does not form part of the Grid Code)

Paragraph No/Title	Page Number
<u>CC.1 INTRODUCTION</u>	2
<u>CC.2 OBJECTIVE</u>	32
<u>CC.3 SCOPE</u>	3
<u>CC.4 PROCEDURE</u>	65
<u>CC.5 CONNECTION</u>	65
<u>CC.6 TECHNICAL, DESIGN AND OPERATIONAL CRITERIA</u>	8
<u>CC.7 SITE RELATED CONDITIONS</u>	8583
<u>CC.8 ANCILLARY SERVICES</u>	9290
<u>APPENDIX 1 - SITE RESPONSIBILITY SCHEDULES</u>	9392
<u>PROFORMA FOR SITE RESPONSIBILITY SCHEDULE</u>	9796
<u>APPENDIX 2 - OPERATION DIAGRAMS</u>	103402
<u>PART 1A - PROCEDURES RELATING TO OPERATION DIAGRAMS</u>	103402
<u>PART 1B - PROCEDURES RELATING TO GAS ZONE DIAGRAMS</u>	106405
<u>PART 2 - NON-EXHAUSTIVE LIST OF APPARATUS TO BE INCLUDED ON OPERATION DIAGRAMS</u>	107406
<u>APPENDIX 4 - FAULT RIDE THROUGH REQUIREMENTS</u>	2
<u>APPENDIX 4A</u>	2
<u>APPENDIX 5 - TECHNICAL REQUIREMENTS LOW FREQUENCY RELAYS FOR THE AUTOMATIC DISCONNECTION OF SUPPLIES AT LOW FREQUENCY</u>	14
<u>APPENDIX 6 - PERFORMANCE REQUIREMENTS FOR CONTINUOUSLY ACTING AUTOMATIC EXCITATION CONTROL SYSTEMS FOR ONSHORE SYNCHRONOUS GENERATING UNITS</u>	17
<u>APPENDIX 7 - PERFORMANCE REQUIREMENTS FOR CONTINUOUSLY ACTING AUTOMATIC VOLTAGE CONTROL SYSTEMS FOR ONSHORE NON-SYNCHRONOUS GENERATING UNITS, ONSHORE DC CONVERTERS, ONSHORE POWER PARK MODULES AND OTSDUW PLANT AND APPARATUS AT THE INTERFACE POINT</u>	22
<u>APPENDIX 7 - PERFORMANCE REQUIREMENTS FOR CONTINUOUSLY ACTING AUTOMATIC VOLTAGE CONTROL SYSTEMS FOR ONSHORE NON-SYNCHRONOUS GENERATING UNITS, ONSHORE DC CONVERTERS, ONSHORE POWER PARK MODULES AND OTSDUW PLANT AND APPARATUS AT THE INTERFACE POINT</u>	22
<u>APPENDIX 7 - PERFORMANCE REQUIREMENTS FOR CONTINUOUSLY ACTING AUTOMATIC VOLTAGE CONTROL SYSTEMS FOR ONSHORE NON-SYNCHRONOUS GENERATING UNITS, ONSHORE DC CONVERTERS, ONSHORE POWER PARK MODULES AND OTSDUW PLANT AND APPARATUS AT THE INTERFACE POINT</u>	30
<u>CC.1 INTRODUCTION</u>	2
<u>CC.2 OBJECTIVE</u>	2
<u>CC.3 SCOPE</u>	3
<u>CC.4 PROCEDURE</u>	5
<u>CC.5 CONNECTION</u>	5
<u>CC.6 TECHNICAL, DESIGN AND OPERATIONAL CRITERIA</u>	8
<u>CC.7 SITE RELATED CONDITIONS</u>	82
<u>CC.8 ANCILLARY SERVICES</u>	89
<u>APPENDIX 1 - SITE RESPONSIBILITY SCHEDULES</u>	90
<u>PROFORMA FOR SITE RESPONSIBILITY SCHEDULE</u>	94

APPENDIX 2 – OPERATION DIAGRAMS	100
PART 1A – PROCEDURES RELATING TO OPERATION DIAGRAMS	100
PART 1B – PROCEDURES RELATING TO GAS ZONE DIAGRAMS	103
PART 2 – NON-EXHAUSTIVE LIST OF APPARATUS TO BE INCLUDED ON OPERATION DIAGRAMS	104
APPENDIX 4 – FAULT RIDE-THROUGH REQUIREMENTS	2
APPENDIX 4A	2
APPENDIX 5 – TECHNICAL REQUIREMENTS LOW-FREQUENCY RELAYS FOR THE AUTOMATIC DISCONNECTION OF SUPPLIES AT LOW-FREQUENCY	4
APPENDIX 6 – PERFORMANCE REQUIREMENTS FOR CONTINUOUSLY ACTING AUTOMATIC EXCITATION CONTROL SYSTEMS FOR ONSHORE SYNCHRONOUS GENERATING UNITS	17
APPENDIX 7 – PERFORMANCE REQUIREMENTS FOR CONTINUOUSLY ACTING AUTOMATIC VOLTAGE CONTROL SYSTEMS FOR ONSHORE NON-SYNCHRONOUS GENERATING UNITS, ONSHORE DC CONVERTERS, ONSHORE POWER PARK MODULES AND OTSDUW PLANT AND APPARATUS AT THE INTERFACE POINT	22
APPENDIX 7 – PERFORMANCE REQUIREMENTS FOR CONTINUOUSLY ACTING AUTOMATIC VOLTAGE CONTROL SYSTEMS FOR ONSHORE NON-SYNCHRONOUS GENERATING UNITS, ONSHORE DC CONVERTERS, ONSHORE POWER PARK MODULES AND OTSDUW PLANT AND APPARATUS AT THE INTERFACE POINT	22
APPENDIX 7 – PERFORMANCE REQUIREMENTS FOR CONTINUOUSLY ACTING AUTOMATIC VOLTAGE CONTROL SYSTEMS FOR ONSHORE NON-SYNCHRONOUS GENERATING UNITS, ONSHORE DC CONVERTERS, ONSHORE POWER PARK MODULES AND OTSDUW PLANT AND APPARATUS AT THE INTERFACE POINT	80

ECC.1 INTRODUCTION

ECC.1.1 The European Connection Conditions ("ECC") specify both:

(a) the minimum technical, design and operational criteria which must be complied with by:

- (i) any **EU Code User** connected to or seeking connection with the **National Electricity Transmission System**, or
- (ii) **EU Generators** or **HVDC System Owners** connected to or seeking connection to a **User's System** which is located in **Great Britain** or **Offshore**, or ~~and~~

~~(iii) Network Operators who are EU Code User's~~

~~(iv) Network Operators who are both GB Code User's and EU Code User's but only in respect of:-~~

~~(a) Their obligations in respect of Embedded Medium Power Stations not subject to a Bilateral Agreement for whom the requirements of ECC.3.1(bf)(iii), and (g) and (h), apply alone; and/or~~

~~(b) The requirements of this ECC only in relation to each EU Grid Supply Point. Network Operator's in respect of all other Grid Supply Points should continue to satisfy the requirements as specified in the CC's.~~

~~Network Operators who are EU Code User's~~

~~Network Operators who only have EU Grid Supply Points~~

~~Notwithstanding the requirements of ECC.1.1(a)(iii)(a)(b) and (c) and (d), Network Operators who own and/or operate EU Grid Supply Points, are only required to satisfy the requirements of this ECC in relation to each EU Grid Supply Point. Network Operators in respect of all other Grid Supply Points should continue to satisfy the requirements as specified in the CC's.~~

~~(iv) Network Operator's who are EU Code User's~~

(iv) **Non-Embedded Customers** who are **EU Code User's** and

(b) the minimum technical, design and operational criteria with which **NGET** will comply in relation to the part of the **National Electricity Transmission System** at the **Connection Site** with **Users**. In the case of any **OTSDUW Plant and Apparatus**, the **ECC** also specify the minimum technical, design and operational criteria which must be complied with by the **User** when undertaking **OTSDUW**.

(c) The requirements of **European Regulation (EU) 2016/631** shall not apply to

(i) **Power Generating Modules** that are installed to provide backup power and operate in parallel with the **Total System** for less than 5 minutes per calendar month while the **System** is in normal state. Parallel operation during maintenance or commissioning of tests of that **Power Generating Module** shall not count towards that five minute limit.

(ii) **Power Generating Modules** connected to the **Transmission System** or **Network Operators System** which are not operated in synchronism with a **Synchronous Area**.

Formatted: Font color: Auto

Formatted: Font color: Auto

Formatted: Font color: Auto

Formatted: Font color: Auto

Formatted: Font color: Auto

Formatted: Font color: Auto

Formatted: Font: Bold

Formatted: Font color: Auto

Formatted: Font color: Auto

Formatted: Font: Bold, Font color: Auto

Formatted: Font color: Auto

Formatted: Font: Bold, Font color: Auto

Formatted: Font color: Auto

Formatted: Font color: Auto

Formatted: Font: Bold

Formatted

Formatted: Font: Bold

Formatted: Font color: Auto

Formatted: Font color: Auto

Formatted: Font color: Auto

Formatted: Font color: Auto

Formatted: Font color: Auto

Formatted: Font color: Auto

Formatted: Font color: Auto

Formatted: Font: Bold

Formatted: Font: Not Bold

Formatted: Indent: Left: 0 cm, First line: 0 cm

Formatted: Font: Bold

Formatted

Formatted: Font: Bold

Formatted: Font: Bold

Formatted: Font: Bold

Formatted: Font: Bold

Formatted: Font: Bold

Formatted: Font: Bold

Formatted: Font: Bold

Formatted: Font: Bold

Formatted: Font: Bold

Formatted: Font color: Auto

Formatted: Font color: Auto

Formatted: Font color: Auto

Formatted: Font color: Auto

Formatted: Font: Bold, Font color: Auto

Formatted: Font color: Auto

Formatted: Font: Bold

Formatted: Font: Bold

Formatted: Indent: Left: 0 cm, First line: 0 cm

Formatted: Highlight

- (iii) **Power Generating Modules** that do not have a permanent **Connection Point** or **User System Entry Point** and used by **NGET** to temporarily provide power when normal **System** capacity is partly or completely unavailable.

ECC.2 OBJECTIVE

ECC.2.1 The objective of the **ECC** is to ensure that by specifying minimum technical, design and operational criteria the basic rules for connection to the **National Electricity Transmission System** and (for certain **Users**) to a **User's System** are similar for all **Users** of an equivalent category and will enable **NGET** to comply with its statutory and **Transmission Licence** obligations and European Regulations.

ECC.2.2 In the case of any **OTSDUW** the objective of the **ECC** is to ensure that by specifying the minimum technical, design and operational criteria the basic rules relating to an **Offshore Transmission System** designed and constructed by an **Offshore Transmission Licensee** and designed and/or constructed by a **User** under the **OTSDUW Arrangements** are equivalent.

ECC.2.3 Provisions of the **ECC** which apply in relation to **OTSDUW** and **OTSUA**, and/or a **Transmission Interface Site**, shall (in any particular case) apply up to the **OTSUA Transfer Time**, whereupon such provisions shall (without prejudice to any prior non-compliance) cease to apply, without prejudice to the continuing application of provisions of the **ECC** applying in relation to the relevant **Offshore Transmission System** and/or **Connection Site**. It is the case therefore that in cases where the **OTSUA** becomes operational prior to the **OTSUA Transfer Time** that a **EU Generator** is required to comply with this **ECC** both as it applies to its **Plant** and **Apparatus** at a **Connection Site/Connection Point** and the **OTSUA** at the **Transmission Interface Site/Transmission Interface Point** until the **OTSUA Transfer Time** and this **ECC** shall be construed accordingly.

ECC.2.4 In relation to **OTSDUW**, provisions otherwise to be contained in a **Bilateral Agreement** may be contained in the **Construction Agreement**, and accordingly a reference in the **ECC** to a relevant **Bilateral Agreement** includes the relevant **Construction Agreement**.

ECC.3 SCOPE

ECC.3.1 The **ECC** applies to **NGET** and to **EU Code Users**, which in the **ECC** means:

- (a) **EU Generators** (other than those which only have **Embedded Small Power Stations**, including those undertaking **OTSDUW** including **Power Generating Modules**, and **DC Connected Power Park Modules**, which satisfy the conditions specified in **ECC.3.6**;
- (b) **Network Operators** which satisfy the conditions specified in **ECC.3.6** and **ECC.3.1(f)**; but only in respect of:-
 - (i) **Network Operators** who are **EU Code User**'s
 - (ii) **Network Operators** who only have **EU Grid Supply Points**
 - (iii) **Embedded Medium Power Stations** not subject to a **Bilateral Agreement** as provided for in **ECC.3.2**, **ECC.3.3**, **EC3.4**, **EC3.5**, **ECC5.1**, **ECC.6.4.4** and **ECA.3.4**; and/or
 - (iv) Notwithstanding the requirements of **ECC3.1-1.4(ba)(i)(ii)** and (iii) ~~(iii)(a)(b)(d) and (d)~~, **Network Operators** who own and/or operate **EU Grid Supply Points**, are only required to satisfy the requirements of this **ECC** in relation to each **EU**

- Formatted: Font color: Auto
- Formatted: Font color: Auto
- Formatted: Font color: Auto
- Formatted: Font color: Auto
- Formatted: Font color: Auto, Highlight
- Formatted: Font: Not Bold, Font color: Auto, Highlight
- Formatted: Font color: Auto, Highlight
- Formatted: Font: Not Bold
- Formatted: Font color: Auto, Highlight
- Formatted: Font color: Auto
- Formatted: Font color: Auto
- Formatted: Indent: Left: 0 cm, First line: 0 cm
- Formatted: Level 2 Text
- Formatted: Font color: Blue
- Formatted: Indent: Left: 3.99 cm, No bullets or numbering
- Formatted: Font: Not Bold
- Formatted: Indent: Left: 3.25 cm, Hanging: 0.75 cm, No bullets or numbering
- Formatted: Font: Not Bold
- Formatted: Font: Bold

~~Grid Supply Point. Network Operator's~~ in respect of all other ~~Grid Supply Points~~ should continue to satisfy the requirements as specified in the ~~CC's~~.

Formatted: Font: Not Bold

Formatted: Font: Not Bold

(c) ~~Non-Embedded Customers~~ ~~who are also EU Code Users~~ which satisfy the conditions specified in ECC.3.6;

Formatted: Font: Not Bold

Formatted: Font: Not Bold

(d) ~~HVDC System Converter Station Owners~~ who are also ~~EU Code User's~~ which satisfy the conditions specified in ECC.3.6; and

Formatted: Font: Bold

(e) ~~BM Participants and Externally Interconnected System Operators~~ who are also ~~EU Code User's~~ in respect of ECC.6.5 only.

Formatted: Font: Not Bold

~~(f) Network Operators who are both GB Code User's and EU Code User's only in respect of Embedded Medium Power Stations not subject to a Bilateral Agreement as provided for in ECC.3.2, ECC.3.3, EC3.4, EC3.5, ECC5.1, ECC.6.4.4 and ECA.3.4~~

Formatted: Font: Bold

Formatted: Font: Bold

~~(g) For the avoidance of doubt this ECC does not apply to Network Operators other than in respect of item ECC.3.1(f) above.~~

~~(g) Demand Facility Owners in respect of Demand Response Services~~

Formatted: Not Highlight

ECC.3.2 The above categories of ~~EU Code User~~ will become bound by the applicable sections of the ECC prior to them generating, distributing, supplying or consuming, as the case may be, and references to the various categories should, therefore, be taken as referring to them in that prospective role.

ECC.3.3 ~~Embedded Medium Power Stations not subject to a Bilateral Agreement and Embedded HVDC Systems not subject to a Bilateral Agreement Provisions.~~

The following provisions apply in respect of ~~Embedded Medium Power Stations not subject to a Bilateral Agreement and Embedded HVDC Systems not subject to a Bilateral Agreement.~~

ECC.3.3.1 The obligations within the ECC that are expressed to be applicable to ~~EU Generators in respect of Embedded Medium Power Stations not subject to a Bilateral Agreement and HVDC System Owners in respect of Embedded HVDC Systems not subject to a Bilateral Agreement~~ (where the obligations are in each case listed in ECC.3.3.2) shall be read and construed as obligations that the ~~Network Operator within whose System any such Medium Power Station or HVDC System is Embedded~~ must ensure are performed and discharged by the ~~EU Generator or the HVDC Owner. Embedded Medium Power Stations not subject to a Bilateral Agreement and Embedded HVDC Systems not subject to a Bilateral Agreement~~ which are located ~~Offshore~~ and which are connected to an ~~Onshore User System~~ will be required to meet the applicable requirements of the Grid Code as though they are an ~~Onshore Generator or Onshore HVDC System Owner~~ connected to an ~~Onshore User System Entry Point.~~

ECC.3.3.2 The ~~Network Operator within whose System a Medium Power Station not subject to a Bilateral Agreement is Embedded or a HVDC System not subject to a Bilateral Agreement is Embedded~~ must ensure that the following obligations in the ECC are performed and discharged by the ~~EU Generator~~ in respect of each such ~~Embedded Medium Power Station or the HVDC System Owner in the case of an Embedded HVDC System:~~

ECC.5.1

ECC.5.2.2

ECC.5.3

ECC.6.1.3

ECC.6.1.5 (b)

ECC.6.3.2, ECC.6.3.3, ECC.6.3.4, ECC.6.3.6, ECC.6.3.7, ECC.6.3.8, ECC.6.3.9, ECC.6.3.10, ECC.6.3.12, ECC.6.3.13, ECC.6.3.15, ECC.6.3.16

ECC.6.4.4

ECC.6.5.6 (where required by ECC.6.4.4)

In respect of ECC.6.2.2.2, ECC.6.2.2.3, ECC.6.2.2.5, ECC.6.1.5(a), ECC.6.1.5(b) and ECC.6.3.11 equivalent provisions as co-ordinated and agreed with the **Network Operator** and **EU Generator** or **HVDC System Owner** may be required. Details of any such requirements will be notified to the **Network Operator** in accordance with ECC.3.5.

ECC.3.3.3 In the case of **Embedded Medium Power Stations** not subject to a **Bilateral Agreement** and **Embedded HVDC Systems** not subject to a **Bilateral Agreement** the requirements in:

ECC.6.1.6

ECC.6.3.8

ECC.6.3.12

ECC.6.3.15

ECC.6.3.16

ECC.6.3.17

that would otherwise have been specified in a **Bilateral Agreement** will be notified to the relevant **Network Operator** in writing in accordance with the provisions of the **CUSC** and the **Network Operator** must ensure such requirements are performed and discharged by the **Generator** or the **HVDC System owner**.

ECC.3.4 In the case of **Offshore Embedded Power Generating Modules** connected to an **Offshore User's System** which directly connects to an **Offshore Transmission System**, any additional requirements in respect of such **Offshore Embedded Power Generating Modules** may be specified in the relevant **Bilateral Agreement** with the **Network Operator** or in any **Bilateral Agreement** between **NGET** and such **Offshore Generator**.

ECC.3.5 In the case of a **Generator** undertaking **OTSDUW** connecting to an **Onshore Network Operator's System**, any additional requirements in respect of such **OTSDUW Plant and Apparatus** will be specified in the relevant **Bilateral Agreement** with the **EU Generator**. For the avoidance of doubt, requirements applicable to **EU Generators** undertaking **OTSDUW** and connecting to a **Network Operator's User System**, shall be consistent with those applicable requirements of **Generators** undertaking **OTSDUW** and connecting to a **Transmission Interface Point**.

~~ECC.3.6 Notwithstanding the requirements of ECC.3.1(f) the requirements of this ECC shall apply to **EU Code Users** in respect of **Power Generating Modules** (including **DC Connected Power Park Modules**), and **HVDC Systems**, **Network Operators** and **Non-Embedded Customers**~~

Formatted: Not Highlight

~~who are also EU Code Users.~~

Formatted: Font: Not Bold

ECC.4 PROCEDURE

ECC.4.1 The CUSC contains certain provisions relating to the procedure for connection to the National Electricity Transmission System or, in the case of Embedded Power Stations or Embedded HVDC Systems, becoming operational and includes provisions relating to certain conditions to be complied with by EU Code Users prior to and during the course of NGET notifying the User that it has the right to become operational. The procedure for an EU Code User to become connected is set out in the Compliance Processes.

ECC.5 CONNECTION

ECC.5.1 The provisions relating to connecting to the National Electricity Transmission System (or to a User's System in the case of a connection of an Embedded Large Power Station or Embedded Medium Power Stations or Embedded HVDC System) are contained in:

- (a) the CUSC and/or CUSC Contract (or in the relevant application form or offer for a CUSC Contract);
- (b) or, in the case of an Embedded Development, the relevant Distribution Code and/or the Embedded Development Agreement for the connection (or in the relevant application form or offer for an Embedded Development Agreement),

and include provisions relating to both the submission of information and reports relating to compliance with the relevant European Connection Conditions for that EU Code User, Safety Rules, commissioning programmes, Operation Diagrams and approval to connect (and their equivalents in the case of Embedded Medium Power Stations not subject to a Bilateral Agreement or Embedded HVDC Systems not subject to a Bilateral Agreement). References in the ECC to the "Bilateral Agreement" and/or "Construction Agreement" and/or "Embedded Development Agreement" shall be deemed to include references to the application form or offer therefor.

ECC.5.2 Items For Submission

ECC.5.2.1 Prior to the Completion Date (or, where the EU Generator is undertaking OTSDUW, any later date specified) under the Bilateral Agreement and/or Construction Agreement, the following is submitted pursuant to the terms of the Bilateral Agreement and/or Construction Agreement:

- (a) updated Planning Code data (both Standard Planning Data and Detailed Planning Data), with any estimated values assumed for planning purposes confirmed or, where practical, replaced by validated actual values and by updated estimates for the future and by updated forecasts for Forecast Data items such as Demand, pursuant to the requirements of the Planning Code;
- (b) details of the Protection arrangements and settings referred to in ECC.6;
- (c) copies of all Safety Rules and Local Safety Instructions applicable at Users' Sites which will be used at the NGET/User interface (which, for the purpose of OC8, must be to NGET's satisfaction regarding the procedures for Isolation and Earthing. For User Sites in Scotland and Offshore NGET will consult the Relevant Transmission Licensee when determining whether the procedures for Isolation and Earthing are satisfactory);

- (d) information to enable NGET to prepare **Site Responsibility Schedules** on the basis of the provisions set out in Appendix 1;
- (e) an **Operation Diagram** for all **HV Apparatus** on the **User** side of the **Connection Point** as described in ECC.7;
- (f) the proposed name of the **User Site** (which shall not be the same as, or confusingly similar to, the name of any **Transmission Site** or of any other **User Site**);
- (g) written confirmation that **Safety Co-ordinators** acting on behalf of the **User** are authorised and competent pursuant to the requirements of **OC8**;
- (h) **RISSP** prefixes pursuant to the requirements of **OC8**. NGET is required to circulate prefixes utilising a proforma in accordance with **OC8**;
- (i) a list of the telephone numbers for **Joint System Incidents** at which senior management representatives nominated for the purpose can be contacted and confirmation that they are fully authorised to make binding decisions on behalf of the **User**, pursuant to **OC9**;
- (j) a list of managers who have been duly authorised to sign **Site Responsibility Schedules** on behalf of the **User**;
- (k) information to enable NGET to prepare **Site Common Drawings** as described in ECC.7;
- (l) a list of the telephone numbers for the **Users** facsimile machines referred to in ECC.6.5.9; and
- (m) for **Sites** in Scotland and **Offshore** a list of persons appointed by the **User** to undertake operational duties on the **User's System** (including any **OTSDUW** prior to the **OTSUA Transfer Time**) and to issue and receive operational messages and instructions in relation to the **User's System** (including any **OTSDUW** prior to the **OTSUA Transfer Time**); and an appointed person or persons responsible for the maintenance and testing of **User's Plant** and **Apparatus**.

ECC.5.2.2 Prior to the **Completion Date** the following must be submitted to NGET by the **Network Operator** in respect of an **Embedded Development**:

- (a) updated **Planning Code** data (both **Standard Planning Data** and **Detailed Planning Data**), with any estimated values assumed for planning purposes confirmed or, where practical, replaced by validated actual values and by updated estimates for the future and by updated forecasts for **Forecast Data** items such as **Demand**, pursuant to the requirements of the **Planning Code**;
- (b) details of the **Protection** arrangements and settings referred to in ECC.6;
- (c) the proposed name of the **Embedded Medium Power Station** or **Embedded HVDC System** (which shall be agreed with NGET unless it is the same as, or confusingly similar to, the name of other **Transmission Site** or **User Site**);

ECC.5.2.3 Prior to the **Completion Date** contained within an **Offshore Transmission Distribution Connection Agreement** the following must be submitted to NGET by the **Network Operator** in respect of a proposed new **Interface Point** within its **User System**:

(a) updated **Planning Code** data (both **Standard Planning Data** and **Detailed Planning Data**), with any estimated values assumed for planning purposes confirmed or, where practical, replaced by validated actual values and by updated estimates for the future and by updated forecasts for **Forecast Data** items such as **Demand**, pursuant to the requirements of the **Planning Code**;

(b) details of the **Protection** arrangements and settings referred to in ECC.6;

(c) the proposed name of the **Interface Point** (which shall not be the same as, or confusingly similar to, the name of any **Transmission Site** or of any other **User Site**);

ECC.5.2.4 In the case of **OTSDUW Plant and Apparatus** (in addition to items under ECC.5.2.1 in respect of the **Connection Site**), prior to the **Completion Date** (or any later date specified) under the **Construction Agreement** the following must be submitted to **NGET** by the **User** in respect of the proposed new **Connection Point** and **Interface Point**:

(a) updated **Planning Code** data (**Standard Planning Data**, **Detailed Planning Data** and **OTSDUW Data and Information**), with any estimated values assumed for planning purposes confirmed or, where practical, replaced by validated actual values and by updated estimates for the future and by updated forecasts for **Forecast Data** items such as **Demand**, pursuant to the requirements of the **Planning Code**;

(b) details of the **Protection** arrangements and settings referred to in ECC.6;

(c) information to enable preparation of the **Site Responsibility Schedules** at the **Transmission Interface Site** on the basis of the provisions set out in Appendix E1.

(d) the proposed name of the **Interface Point** (which shall not be the same as, or confusingly similar to, the name of any **Transmission Site** or of any other **User Site**);

ECC.5.3 (a) Of the items ECC.5.2.1 (c), (e), (g), (h), (k) and (m) need not be supplied in respect of **Embedded Power Stations** or **Embedded HVDC Systems**,

(b) item ECC.5.2.1(i) need not be supplied in respect of **Embedded Small Power Stations** and **Embedded Medium Power Stations** or **Embedded HVDC Systems** with a **Registered Capacity** of less than 100MW, and

(c) items ECC.5.2.1(d) and (j) are only needed in the case where the **Embedded Power Station** or the **Embedded HVDC System** is within a **Connection Site** with another **User**.

ECC.5.4 In addition, at the time the information is given under ECC.5.2(g), **NGET** will provide written confirmation to the **User** that the **Safety Co-ordinators** acting on behalf of **NGET** are authorised and competent pursuant to the requirements of **OC8**.

ECC.6 TECHNICAL, DESIGN AND OPERATIONAL CRITERIA

ECC.6.1 National Electricity Transmission System Performance Characteristics

ECC.6.1.1 NGET shall ensure that, subject as provided in the **Grid Code**, the **National Electricity Transmission System** complies with the following technical, design and operational criteria in relation to the part of the **National Electricity Transmission System** at the **Connection Site** with a **User** and in the case of **OTSDUW Plant and Apparatus**, a **Transmission Interface Point** (unless otherwise specified in ECC.6) although in relation to operational criteria NGET may be unable (and will not be required) to comply with this obligation to the extent that there are insufficient **Power Stations** or **User Systems** are not available or **Users** do not comply with **NGET's** instructions or otherwise do not comply with the **Grid Code** and each **User** shall ensure that its **Plant** and **Apparatus** complies with the criteria set out in **ECC.6.1.5**.

ECC.6.1.2 Grid Frequency Variations

ECC.6.1.2.1 Grid Frequency Variations ~~for EU Code User's excluding HVDC Equipment~~

ECC.6.1.2.1.1 The **Frequency** of the **National Electricity Transmission System** shall be nominally 50Hz and shall be controlled within the limits of 49.5 - 50.5Hz unless exceptional circumstances prevail.

ECC.6.1.2.1.2 The **System Frequency** could rise to 52Hz or fall to 47Hz in exceptional circumstances. Design of ~~EU Code~~ **User's Plant** and **Apparatus** and **OTSDUW Plant and Apparatus** must enable operation of that **Plant** and **Apparatus** within that range in accordance with the following:

<u>Frequency Range</u>	<u>Requirement</u>
51.5Hz - 52Hz	Operation for a period of at least 15 minutes is required each time the Frequency is above 51.5Hz.
51Hz - 51.5Hz	Operation for a period of at least 90 minutes is required each time the Frequency is above 51Hz.
49.0Hz - 51Hz	Continuous operation is required
47.5Hz - 49.0Hz	Operation for a period of at least 90 minutes is required each time the Frequency is below 49.0Hz.
47Hz - 47.5Hz	Operation for a period of at least 20 seconds is required each time the Frequency is below 47.5Hz.

ECC.6.1.2.1.3 For the avoidance of doubt, disconnection, by frequency or speed based relays is not permitted within the frequency range 47.5Hz to 51.5Hz. **EU Generators** should however be aware of the combined voltage and frequency operating ranges as defined in ECC.6.3.12 and ECC.6.3.13.

ECC.6.1.2.1.4 **NGET** in co-ordination with the **Relevant Transmission Licensee** and/or **Network Operator** and a **User** may agree on wider variations in frequency or longer minimum operating times to those set out in ECC.6.1.2.1.2 or specific requirements for combined frequency and voltage deviations. Any such requirements in relation to **Power Generating Modules** shall be in accordance with ECC.6.3.12 and ECC.6.3.13. An ~~EU Code~~ **User** shall not unreasonably withhold consent to apply wider frequency ranges or longer minimum times for operation taking account of their economic and technical feasibility.

ECC.6.1.2.2 Grid Frequency variations for HVDC Systems and Remote End HVDC Converter Stations

ECC.6.1.2.2.1 **HVDC Systems and Remote End HVDC Converter Stations** shall be capable of staying connected to the **System** and remaining operable within the frequency ranges and time periods specified in Table ECC.6.1.2.2 below. This requirement shall continue to apply during the **Fault Ride Through** conditions defined in ECC.6.3.15

Frequency Range (Hz)	Time Period for Operation (s)
47.0 – 47.5Hz	60 seconds
47.5 – 49.0Hz	90 minutes and 30 seconds
49.0 – 51.0Hz	Unlimited
51.0 – 51.5Hz	90 minutes and 30 seconds
51.5Hz – 52 Hz	20 minutes

Table ECC.6.1.2.2 – Minimum time periods **HVDC Systems and Remote End HVDC Converter Stations** shall be able to operate for different frequencies deviating from a nominal value without disconnecting from the **National Electricity Transmission System**

ECC.6.1.2.2.2 **NGET** in coordination with the **Relevant Transmission Licensee** and a **HVDC System Owner** may agree wider frequency ranges or longer minimum operating times if required to preserve or restore system security. If wider frequency ranges or longer minimum times for operation are economically and technically feasible, the **HVDC System Owner** shall not unreasonably withhold consent.

ECC.6.1.2.2.3 Notwithstanding the requirements of ECC.6.1.2.2.1, an **HVDC System or Remote End HVDC Converter Station** shall be capable of automatic disconnection at frequencies specified by **NGET** and/or **Relevant Network Operator**.

ECC.6.1.2.2.4 In the case of **Remote End HVDC Converter Stations** where the **Remote End HVDC Converter Station** is operating at either nominal frequency other than 50Hz or a variable frequency, the requirements defined in ECC.6.1.2.2.1 to ECC.6.1.2.2.3 shall apply to the **Remote End HVDC Converter Station** other than in respect of the frequency ranges and time periods.

ECC.6.1.2.3 **Grid Frequency Variations for DC Connected Power Park Modules**

ECC.6.1.2.3.1 **DC Connected Power Park Modules** shall be capable of staying connected to the **Remote End DC Converter** network at the HVDC Interface Point and operating within the **Frequency** ranges and time periods specified in Table ECC.6.1.2.3 below. Where a nominal frequency other than 50Hz, or a **Frequency** variable by design is used as agreed with **NGET** and the **Relevant Transmission Licensee** the applicable **Frequency** ranges and time periods shall be specified in the **Bilateral Agreement** which shall (where applicable) reflect the requirements in Table ECC.6.1.2.3 .

Frequency Range (Hz)	Time Period for Operation (s)
47.0 – 47.5Hz	20 seconds
47.5 – 49.0Hz	90 minutes
49.0 – 51.0Hz	Unlimited
51.0 – 51.5Hz	90 minutes
51.5Hz – 52 Hz	15 minutes

Table ECC.6.1.2.3 – Minimum time periods a DC Connected Power Park Module shall be able to operate for different frequencies deviating from a nominal value without disconnecting from the System

ECC.6.1.2.3.2 NGET in coordination with the Relevant Transmission Licensee and a Generator may agree wider frequency ranges or longer minimum operating times if required to preserve or restore system security and to ensure the optimum capability of the DC Connected Power Park Module. If wider frequency ranges or longer minimum times for operation are economically and technically feasible, the EU Generator shall not unreasonably withhold consent.

ECC.6.1.3 Not used

ECC.6.1.4 Grid Voltage Variations

ECC.6.1.4.1 Grid Voltage Variations for ~~all EU Code Users~~ excluding DC Connected Power Park Modules and Remote End HVDC Converters

Subject as provided below, the voltage on the 400kV part of the National Electricity Transmission System at each Connection Site with a User (and in the case of OTSDUW Plant and Apparatus, a Transmission Interface Point, excluding DC Connected Power Park Modules and Remote End HVDC Converters) will normally remain within $\pm 5\%$ of the nominal value unless abnormal conditions prevail. The minimum voltage is -10% and the maximum voltage is +10% unless abnormal conditions prevail, but voltages between +5% and +10% will not last longer than 15 minutes unless abnormal conditions prevail. Voltages on the 275kV and 132kV parts of the National Electricity Transmission System at each Connection Point (and in the case of OTSDUW Plant and Apparatus, a Transmission Interface Point) will normally remain within the limits $\pm 10\%$ of the nominal value unless abnormal conditions prevail. At nominal System voltages below 110kV the voltage of the National Electricity Transmission System at each Connection Site with a User (and in the case of OTSDUW Plant and Apparatus, a Transmission Interface Point), excluding Connection Sites for DC Connected Power Park Modules and Remote End HVDC Converters) will normally remain within the limits $\pm 6\%$ of the nominal value unless abnormal conditions prevail. Under fault conditions, the voltage may collapse transiently to zero at the point of fault until the fault is cleared. The normal operating ranges of the National Electricity Transmission System are summarised in Table ECC.6.1.4.1 below:

National Electricity Transmission System Nominal Voltage	Normal Operating Range	Time period for Operation
400kV	400kV -10% to +5%	Unlimited
	400kV +5% to +10%	15 minutes
275kV	275kV $\pm 10\%$	Unlimited
132kV	132kV $\pm 10\%$	Unlimited
110kV	110kV $\pm 10\%$	Unlimited
Below 110kV	Below 110kV $\pm 6\%$	Unlimited

Table ECC.6.1.4.1

Formatted: Font color: Auto

Formatted: Font color: Auto

Formatted: Font color: Auto

Formatted: Font color: Auto

Formatted: Font color: Auto

Formatted: Font color: Auto

Formatted: Font color: Auto

Formatted: Font color: Auto

Formatted: Font color: Auto

Formatted: Font: 11 pt, Font color: Auto

Formatted: Font color: Auto

Formatted: Font color: Auto

Formatted: Font color: Auto

Formatted: Font color: Auto

Formatted: Font color: Auto

Formatted: Font color: Auto

Formatted: Font color: Auto

Formatted: Font color: Auto

Formatted: Font color: Auto

Formatted: Font color: Auto

Formatted: Font color: Auto

Formatted: Font color: Auto

Formatted: Font color: Auto

Formatted: Font color: Auto

Formatted: Font color: Auto

Formatted: Font color: Auto

Formatted: Font color: Auto

NGET and a EU Code-User may agree greater variations or longer minimum time periods of operation in voltage to those set out above in relation to a particular Connection Site, and insofar as a greater variation is agreed, the relevant figure set out above shall, in relation to that EU Code-User at the particular Connection Site, be replaced by the figure agreed.

Formatted: Font color: Auto

Network Operators Systems and Non-Embedded Customers Systems at each EU Grid Supply Point connected at a nominal voltage of 110kV or greater must continue to operate within the voltage and time periods specified in ECC.6.1.4.1 and Table ECC.6.1.4.1 unless NGET has agreed to any voltage level relays which will automatically trip such Network Operators Systems or Non-Embedded Customers Systems as specified under the Bilateral Agreement. The terms and settings for automatic tripping shall be agreed between NGET, in co-ordination with the Relevant Transmission Licensee and the relevant Network Operator or the Non-Embedded Customer.

Formatted: Font: Bold

Formatted: Font color: Auto

Formatted: Font color: Auto

Formatted: Font color: Auto

Formatted: Font color: Auto

ECC.6.1.4.2 Grid Voltage Variations for all DC Connected Power Park Modules

ECC.6.1.4.2.1 All DC Connected Power Park Modules shall be capable of staying connected to the Remote End HVDC Converter Station at the HVDC Interface Point and operating within the voltage ranges and time periods specified in Tables ECC.6.1.4.2(a) and ECC.6.1.4.2(b) below. The applicable voltage range and time periods specified are selected based on the reference 1pu voltage.

Voltage Range (pu)	Time Period for Operation (s)
0.85pu – 0.9pu	60 minutes
0.9pu – 1.1pu	Unlimited
1.1pu – 1.15pu	15 minutes

Table ECC.6.1.4.2(a) – Minimum time periods for which DC Connected Power Park Modules shall be capable of operating for different voltages deviating from reference 1pu without disconnecting from the network where the nominal voltage base is 110kV or above and less than 300kV.

Voltage Range (pu)	Time Period for Operation (s)
0.85pu – 0.9pu	60 minutes
0.9pu – 1.05pu	Unlimited
1.05pu – 1.15pu	15 minutes

Table ECC.6.1.4.2(b) – Minimum time periods for which DC Connected Power Park Modules shall be capable of operating for different voltages deviating from reference 1pu without disconnecting from the network where the nominal voltage base is from 300kV up to and including 400kV.

ECC.6.1.4.2.2 NGET and a EU Generator in respect of a DC Connected Power Park Module may agree greater voltage ranges or longer minimum operating times. If greater voltage ranges or longer minimum times for operation are economically and technically feasible, the EU Generator shall not unreasonably withhold any agreement.

ECC.6.1.4.2.3 For **DC Connected Power Park Modules** which have an **HVDC Interface Point** to the **Remote End HVDC Converter Station**, **NGET** in coordination with the **Relevant Transmission Licensee** may specify voltage limits at the **HVDC Interface Point** at which the **DC Connected Power Park Module** is capable of automatic disconnection.

ECC.6.1.4.2.4 For **HVDC Interface Points** which fall outside the scope of ECC.6.1.4.2.1, ECC.6.1.4.2.2 and ECC.6.1.4.2.3, **NGET** in coordination with the **Relevant Transmission Licensee** shall specify any applicable requirements at the **Grid Entry Point** or **User System Entry Point**.

ECC.6.1.4.2.5 Where the nominal frequency of the AC collector **System** which is connected to an **HVDC Interface Point** is at a value other than 50Hz, the voltage ranges and time periods specified by **NGET** in coordination with the **Relevant Transmission Licensee** shall be proportional to the values specified in Table ~~Table~~ ECC.6.1.4.2(a) and Table ECC.6.1.4.2(b)

ECC.6.1.4.3 Grid Voltage Variations for all Remote End HVDC Converters

ECC.6.1.4.3.1 All **Remote End HVDC Converter Stations** shall be capable of staying connected to the **HVDC Interface Point** and operating within the voltage ranges and time periods specified in Tables ECC.6.1.4.3(a) and ECC.6.1.4.3(b) below. The applicable voltage range and time periods specified are selected based on the reference 1pu voltage.

Voltage Range (pu)	Time Period for Operation (s)
0.85pu – 0.9pu	60 minutes
0.9pu – 1.1pu	Unlimited
1.1pu – 1.15pu	15 minutes

Table ECC.6.1.4.3(a) – Minimum time periods for which a **Remote End HVDC Converter** shall be capable of operating for different voltages deviating from reference 1pu without disconnecting from the network where the nominal voltage base is 110kV or above and less than 300kV.

Voltage Range (pu)	Time Period for Operation (s)
0.85pu – 0.9pu	60 minutes
0.9pu – 1.05pu	Unlimited
1.05pu – 1.15pu	15 minutes

Table ECC.6.1.4.3(b) – Minimum time periods for which a **Remote End HVDC Converter** shall be capable of operating for different voltages deviating from reference 1pu without disconnecting from the network where the nominal voltage base is from 300kV up to and including 400kV.

ECC.6.1.4.3.2 **NGET** and a **HVDC System Owner** may agree greater voltage ranges or longer minimum operating times which shall be in accordance with the requirements of ECC.6.1.4.2.

ECC.6.1.4.3.4 For **HVDC Interface Points** which fall outside the scope of ECC.6.1.4.3.1 **NGET** in coordination with the **Relevant Transmission Licensee** shall specify any applicable requirements at the **Grid Entry Point** or **User System Entry Point**.

ECC.6.1.4.3.5 Where the nominal frequency of the AC collector System which is connected to an HVDC Interface Point is at a value other than 50Hz, the voltage ranges and time periods specified by NGET in coordination with the Relevant Transmission Licensee shall be proportional to the values specified in Table ECC.6.1.4.3(a) and Table ECC.6.1.4.3(b)

Voltage Waveform Quality

ECC.6.1.5 All Plant and Apparatus connected to the National Electricity Transmission System, and that part of the National Electricity Transmission System at each Connection Site or, in the case of OTSDUW Plant and Apparatus, at each Interface Point, should be capable of withstanding the following distortions of the voltage waveform in respect of harmonic content and phase unbalance:

(a) Harmonic Content

The Electromagnetic Compatibility Levels for harmonic distortion on the Onshore Transmission System from all sources under both Planned Outage and fault outage conditions, (unless abnormal conditions prevail) shall comply with the levels shown in the tables of Appendix A of Engineering Recommendation G5/4. The Electromagnetic Compatibility Levels for harmonic distortion on an Offshore Transmission System will be defined in relevant Bilateral Agreements.

Engineering Recommendation G5/4 contains planning criteria which NGET will apply to the connection of non-linear Load to the National Electricity Transmission System, which may result in harmonic emission limits being specified for these Loads in the relevant Bilateral Agreement. The application of the planning criteria will take into account the position of existing User's and EU Code Users' Plant and Apparatus (and OTSDUW Plant and Apparatus) in relation to harmonic emissions. Users must ensure that connection of distorting loads to their User Systems do not cause any harmonic emission limits specified in the Bilateral Agreement, or where no such limits are specified, the relevant planning levels specified in Engineering Recommendation G5/4 to be exceeded.

(b) Phase Unbalance

Under Planned Outage conditions, the weekly 95 percentile of Phase (Voltage) Unbalance, calculated in accordance with IEC 61000-4-30 and IEC 61000-3-13, on the National Electricity Transmission System for voltages above 150kV should remain, in England and Wales, below 1.5%, and in Scotland, below 2%, and for voltages of 150kV and below, across GB below 2%, unless abnormal conditions prevail and Offshore (or in the case of OTSDUW, OTSDUW Plant and Apparatus) will be defined in relevant Bilateral Agreements.

The Phase Unbalance is calculated from the ratio of root mean square (rms) of negative phase sequence voltage to rms of positive phase sequence voltage, based on 10-minute average values, in accordance with IEC 61000-4-30.

ECC.6.1.6 Across GB, under the Planned Outage conditions stated in ECC.6.1.5(b) infrequent short duration peaks with a maximum value of 2% are permitted for Phase (Voltage) Unbalance, for voltages above 150kV, subject to the prior agreement of NGET under the Bilateral Agreement and in relation to OTSDUW, the Construction Agreement. NGET will only agree following a specific assessment of the impact of these levels on Transmission Apparatus and other Users Apparatus with which it is satisfied.

Voltage Fluctuations

ECC.6.1.7 Voltage changes at a **Point of Common Coupling** on the **Onshore Transmission System** shall not exceed:

(a) The limits specified in Table ECC.6.1.7 with the stated frequency of occurrence, where:

$$|\% \Delta V_{\text{steadystate}}| = 100 \times \frac{|\Delta V_{\text{steadystate}}|}{V_0} \quad (i)$$

and

$$|\% \Delta V_{\text{max}}| = 100 \times \frac{|\Delta V_{\text{max}}|}{V_0} ;$$

- (ii) V_0 is the initial steady state system voltage;
- (iii) $V_{\text{steadystate}}$ is the system voltage reached when the rate of change of system voltage over time is less than or equal to 0.5% over 1 second and $|\Delta V_{\text{steadystate}}|$ is the absolute value of the difference between $V_{\text{steadystate}}$ and V_0 ;
- (iv) $|\Delta V_{\text{max}}|$ is the absolute value of the maximum change in the system voltage relative to the initial steady state system voltage of V_0 ;
- (v) All voltages are the root mean square of the voltage measured over one cycle refreshed every half a cycle as per IEC 61000-4-30;
- (vi) The voltage changes specified are the absolute maximum allowed, applied to phase to ground or phase to phase voltages whichever is the highest change;
- (vii) Voltage changes in category 3 do not exceed the limits depicted in the time dependant characteristic shown in Figure ECC.6.1.7;
- (viii) Voltage changes in category 3 only occur infrequently, typically not planned more than once per year on average over the lifetime of a connection, and in circumstances notified to **NGET**, such as for example commissioning in accordance with a commissioning programme, implementation of a planned outage notified in accordance with **OC2** or an **Operation** or **Event** notified in accordance with **OC7**; and
- (ix) For connections where voltage changes would constitute a risk to the **National Electricity Transmission System** or, in **NGET's** view, the **System** of any **User**, **Bilateral Agreements** may include provision for **NGET** to reasonably limit the number of voltage changes in category 2 or 3 to a lower number than specified in Table ECC.6.1.7 to ensure that the total number of voltage changes at the **Point of Common Coupling** across multiple **Users** remains within the limits of Table ECC.6.1.7.

Category	Maximum number of Occurrences	$ \% \Delta V_{\text{max}} $ & $ \% \Delta V_{\text{steadystate}} $
1	No Limit	$ \% \Delta V_{\text{max}} \leq 1\% \& \% \Delta V_{\text{steadystate}} \leq 1\%$
2	$\frac{3600}{\sqrt[0.304]{2.5 \times \% \Delta V_{\text{max}}}}$	$1\% < \% \Delta V_{\text{max}} \leq 3\% \& \% \Delta V_{\text{steadystate}} \leq 3\%$

	occurrences per hour with events evenly distributed	
3	No more than 4 per day for Commissioning, Maintenance and Fault Restoration	<p>For decreases in voltage:</p> <p>$\% \Delta V_{\max} \leq 12\%^1$ & $\% \Delta V_{\text{steadystate}} \leq 3\%$</p> <p>For increases in voltage:</p> <p>$\% \Delta V_{\max} \leq 5\%^2$ & $\% \Delta V_{\text{steadystate}} \leq 3\%$</p> <p>(see Figure ECC6.1.7)</p>

Table ECC.6.1.7 - Limits for Rapid Voltage Changes

- ¹ A decrease in voltage of up to 12% is permissible for up to 80ms, as highlighted in the shaded area in Figure ECC.6.1.7, reducing to up to 10% after 80ms and to up to 3% after 2 seconds.
- ² An increase in voltage of up to 5% is permissible if it is reduced to up to 3% after 0.5 seconds.

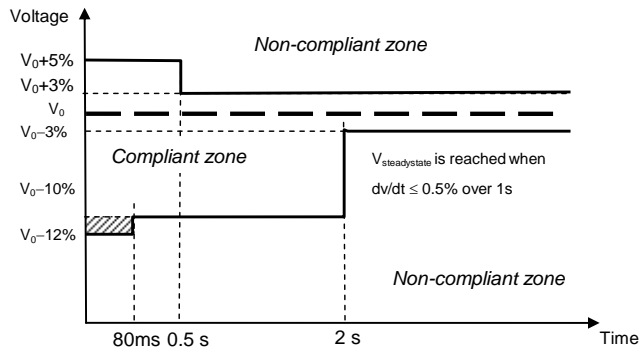

Figure ECC.6.1.7 - Time and magnitude limits for a category 3 Rapid Voltage Change

(b) For voltages above 132kV, **Flicker Severity (Short Term)** of 0.8 Unit and a **Flicker Severity (Long Term)** of 0.6 Unit, for voltages 132kV and below, **Flicker Severity (Short Term)** of 1.0 Unit and a **Flicker Severity (Long Term)** of 0.8 Unit, as set out in **Engineering Recommendation P28** as current at the **Transfer Date**.

ECC.6.1.8 Voltage fluctuations at a **Point of Common Coupling** with a fluctuating **Load** directly connected to an **Offshore Transmission System** (or in the case of **OTSDUW, OTSDUW Plant and Apparatus**) shall not exceed the limits set out in the **Bilateral Agreement**.

Sub-Synchronous Resonance and Sub-Synchronous Torsional Interaction (SSTI)

Formatted: Highlight

ECC.6.1.9 NGET shall ensure that **Users' Plant and Apparatus** will not be subject to unacceptable Sub-Synchronous Oscillation conditions as specified in the relevant **Licence Standards**.

ECC.6.1.10 NGET shall ensure where necessary, and in consultation with **Transmission Licensees** where required, that any relevant site specific conditions applicable at a **User's Connection Site**, including a description of the Sub-Synchronous Oscillation conditions considered in the application of the relevant **License Standards**, are set out in the **User's Bilateral Agreement**.

ECC.6.2 Plant and Apparatus relating to Connection Sites and Interface Points and HVDC Interface Points

The following requirements apply to **Plant** and **Apparatus** relating to the **Connection Point** and **OTSDUW Plant and Apparatus** relating to the **Interface Point** (until the **OTSUA Transfer Time**), **HVDC Interface Points** relating to **Remote End HVDC Converters** and **Connection Points** which (except as otherwise provided in the relevant paragraph) each **EU Code User** must ensure are complied with in relation to its **Plant** and **Apparatus** and which in the case of ECC.6.2.2.2.2, ECC.6.2.3.1.1 and ECC.6.2.1.1(b) only, **NGET** must ensure are complied with in relation to **Transmission Plant** and **Apparatus**, as provided in those paragraphs.

ECC.6.2.1 General Requirements

- ECC.6.2.1.1 (a) The design of connections between the **National Electricity Transmission System** and:
- (i) any **Power Generating Module Generating Unit** (other than a **CCGT Unit** or **Power Park Unit**) **HVDC Equipment, Power Park Module** or **CCGT Module**, or
 - (ii) any **Network Operator's User System** who is an EU Code User, or
 - (iii) **Non-Embedded Customers** equipment;
- will be consistent with the **Licence Standards**.

Formatted: Font: Not Bold

In the case of **OTSDUW**, the design of the **OTSUA's** connections at the **Interface Point** and **Connection Point** will be consistent with **Licence Standards**.

- (b) The **National Electricity Transmission System** (and any **OTSDUW Plant and Apparatus**) at nominal **System** voltages of 132kV and above is/shall be designed to be earthed with an **Earth Fault Factor** of, in England and Wales or **Offshore**, below 1.4 and in Scotland, below 1.5. Under fault conditions the rated **Frequency** component of voltage could fall transiently to zero on one or more phases or, in England and Wales, rise to 140% phase-to-earth voltage, or in Scotland, rise to 150% phase-to-earth voltage. The voltage rise would last only for the time that the fault conditions exist. The fault conditions referred to here are those existing when the type of fault is single or two phase-to-earth.
- (c) For connections to the **National Electricity Transmission System** at nominal **System** voltages of below 132kV the earthing requirements and voltage rise conditions will be advised by **NGET** as soon as practicable prior to connection and in the case of **OTSDUW Plant and Apparatus** shall be advised to **NGET** by the **EU Code User**.

ECC.6.2.1.2 Substation Plant and Apparatus

- (a) The following provisions shall apply to all **Plant** and **Apparatus** which is connected at the voltage of the **Connection Point** (and **OTSDUW Plant and Apparatus** at the **Interface Point**) and which is contained in equipment bays that are within the **Transmission** busbar **Protection** zone at the **Connection Point**. This includes circuit breakers, switch disconnectors, disconnectors, **Earthing Devices**, power transformers, voltage transformers, reactors, current transformers, surge arresters, bushings, neutral equipment, capacitors, line traps, coupling devices, external insulation and insulation co-ordination devices. Where necessary, this is as more precisely defined in the **Bilateral Agreement**.

- (ii) Plant and/or Apparatus in respect of EU Code User's connecting to a new

Formatted: Font: Not Bold

Formatted: Font: Not Bold

Connection Point (including OTSDUW Plant and Apparatus at the Interface Point)

Formatted: Font: Not Bold

Each item of such **Plant** and/or **Apparatus** installed in relation to a new **Connection Point** (or **OTSDUW Plant and Apparatus** at the **Interface Point** or **Remote End HVDC Converter Station** at the **HVDC Interface Point**) shall comply with the relevant **Technical Specifications** and any further requirements identified by **NGET**, acting reasonably, to reflect the options to be followed within the **Technical Specifications** and/or to complement if necessary the **Technical Specifications** so as to enable **NGET** to comply with its obligations in relation to the **National Electricity Transmission System** or, in Scotland or **Offshore**, the **Relevant Transmission Licensee** to comply with its obligations in relation to its **Transmission System**. This information, including the application dates of the relevant **Technical Specifications**, will be as specified in the **Bilateral Agreement**.

Formatted: Font: Not Bold

Formatted: Font: Not Bold

- (iii) EU Code User's Plant and/or Apparatus connecting to an existing Connection Point (including OTSDUW Plant and Apparatus at the Interface Point

Formatted: Font: Not Bold

Formatted: Font: Not Bold

Formatted: Font: Not Bold

Each new additional and/or replacement item of such **Plant** and/or **Apparatus** installed in relation to a change to an existing **Connection Point** (or **OTSDUW Plant and Apparatus** at the **Interface Point** and **Connection Point** or **Remote End HVDC Converter Stations** at the **HVDC Interface Point**)—shall comply with the standards/specifications applicable when the change was designed, or such other standards/specifications as necessary to ensure that the item of **Plant** and/or **Apparatus** is reasonably fit for its intended purpose having due regard to the obligations of **NGET**, the relevant **User** and, in Scotland, or **Offshore**, also the **Relevant Transmission Licensee** under their respective **Licences**. Where appropriate this information, including the application dates of the relevant standards/specifications, will be as specified in the varied **Bilateral Agreement**.

- (iv) Used Plant and/or Apparatus being moved, re-used or modified

If, after its installation, any such item of **Plant** and/or **Apparatus** is subsequently:

moved to a new location; or

used for a different purpose; or

otherwise modified;

then the standards/specifications as described in (i) or (ii) above as applicable will apply as appropriate to such **Plant** and/or **Apparatus**, which must be reasonably fit for its intended purpose having due regard to the obligations of **NGET**, the relevant **User** and, in Scotland or **Offshore**, also the **Relevant Transmission Licensee** under their respective **Licences**.

- (b) **NGET** shall at all times maintain a list of those **Technical Specifications** and additional requirements which might be applicable under this ECC.6.2.1.2 and which may be referenced by **NGET** in the **Bilateral Agreement**. **NGET** shall provide a copy of the list upon request to any **EU Code User**. **NGET** shall also provide a copy of the list to any **EU Code User** upon receipt of an application form for a **Bilateral Agreement** for a new **Connection Point**.

- (c) Where the **EU Code User** provides **NGET** with information and/or test reports in respect of **Plant** and/or **Apparatus** which the **EU Code User** reasonably believes demonstrate the compliance of such items with the provisions of a **Technical Specification** then **NGET** shall promptly and without unreasonable delay give due and proper consideration to such information.
- (d) **Plant** and **Apparatus** shall be designed, manufactured and tested in premises with an accredited certificate in accordance with the quality assurance requirements of the relevant standard in the BS EN ISO 9000 series (or equivalent as reasonably approved by **NGET**) or in respect of test premises which do not include a manufacturing facility premises with an accredited certificate in accordance with BS EN 45001.
- (e) Each connection between a **User** and the **National Electricity Transmission System** must be controlled by a circuit-breaker (or circuit breakers) capable of interrupting the maximum short circuit current at the point of connection. The **Seven Year Statement** gives values of short circuit current and the rating of **Transmission** circuit breakers at existing and committed **Connection Points** for future years.
- (f) Each connection between a **Generator** undertaking **OTSDUW** or an **Onshore Transmission Licensee**, must be controlled by a circuit breaker (or circuit breakers) capable of interrupting the maximum short circuit current at the **Transmission Interface Point**. The **Seven Year Statement** gives values of short circuit current and the rating of **Transmission** circuit breakers at existing and committed **Transmission Interface Points** for future years.

ECC.6.2.2 Requirements at Connection Points or, in the case of OTSDUW at Interface Points that relate to Generators or OTSDUW Plant and Apparatus

ECC.6.2.2.1 Not Used.

ECC.6.2.2.2 Power Generating Module, OTSDUW Plant and Apparatus, HVDC Equipment and Power Station Protection Arrangements

ECC.6.2.2.2.1 Minimum Requirements

Protection of Power Generating Modules (other than Power Park Units), HVDC Equipment, OTSDUW Plant and Apparatus and their connections to the National Electricity Transmission System shall meet the requirements given below. These are necessary to reduce the impact on the National Electricity Transmission System of faults on OTSDUW Plant and Apparatus circuits or circuits owned by Generators (including DC Connected Power Park Modules) or HVDC System Owners.

ECC.6.2.2.2.2 Fault Clearance Times

(a) The required fault clearance time for faults on the **Generator's (including DC Connected Power Park Modules) or HVDC System Owner's equipment directly connected to the National Electricity Transmission System or OTSDUW Plant and Apparatus** and for faults on the **National Electricity Transmission System directly connected to the EU Generator (including DC Connected Power Park Modules) or HVDC System Owner's equipment or OTSDUW Plant and Apparatus**, from fault inception to the circuit breaker arc extinction, shall be set out in the **Bilateral Agreement**. The fault clearance time specified in the **Bilateral Agreement** shall not be shorter than the durations specified below:

- (i) 80ms at 400kV
- (ii) 100ms at 275kV

(iii) 120ms at 132kV and below

but this shall not prevent the **User** or **NGET** or the **Relevant Transmission Licensee** or the **EU Generator** (including in respect of **OTSDUW Plant and Apparatus** and **DC Connected Power Park Modules**) from selecting a shorter fault clearance time on their own **Plant and Apparatus** provided **Discrimination** is achieved.

A longer fault clearance time may be specified in the **Bilateral Agreement** for faults on the **National Electricity Transmission System**. A longer fault clearance time for faults on the **EU Generator** or **HVDC System Owner's** equipment or **OTSDUW Plant and Apparatus** may be agreed with **NGET** in accordance with the terms of the **Bilateral Agreement** but only if **System** requirements, in **NGET's** view, permit. The probability that the fault clearance time stated in the **Bilateral Agreement** will be exceeded by any given fault, must be less than 2%.

(b) In the event that the required fault clearance time is not met as a result of failure to operate on the **Main Protection System(s)** provided, the **Generators** or **HVDC System Owners** or **Generators** in the case of **OTSDUW Plant and Apparatus** shall, except as specified below provide **Independent Back-Up Protection**. **NGET** will also provide **Back-Up Protection** and **NGET** and the **User's Back-Up Protections** will be co-ordinated so as to provide **Discrimination**.

On a **Power Generating Module** (other than a **Power Park Unit**), **HVDC Equipment** or **OTSDUW Plant and Apparatus** and connected to the **National Electricity Transmission System** at 400kV or 275kV and where two **Independent Main Protections** are provided to clear faults on the **HV Connections** within the required fault clearance time, the **Back-Up Protection** provided by **EU Generators** (including in respect of **OTSDUW Plant and Apparatus** and **DC Connected Power Park Modules**) and **HVDC System Owners** shall operate to give a fault clearance time of no longer than 300ms at the minimum infeed for normal operation for faults on the **HV Connections**. Where two **Independent Main Protections** are installed the **Back-Up Protection** may be integrated into one (or both) of the **Independent Main Protection** relays.

On a **Power Generating Module** (other than a **Power Park Unit**), **HVDC Equipment** or **OTSDUW Plant and Apparatus** and connected to the **National Electricity Transmission System** at 132 kV and where only one **Main Protection** is provided to clear faults on the **HV Connections** within the required fault clearance time, the **Independent Back-Up Protection** provided by the **Generator** (including in respect of **OTSDUW Plant and Apparatus** and **DC Connected Power Park Modules**) and the **HVDC System Owner** shall operate to give a fault clearance time of no longer than 300ms at the minimum infeed for normal operation for faults on the **HV Connections**.

A **Power Generating Module** (other than a **Power Park Unit**), **HVDC Equipment** or **OTSDUW Plant and Apparatus**) with **Back-Up Protection** or **Independent Back-Up Protection** will also be required to withstand, without tripping, the loading incurred during the clearance of a fault on the **National Electricity Transmission System** by breaker fail **Protection** at 400kV or 275kV or of a fault cleared by **Back-Up Protection** where the **EU Generator** (including in the case of **OTSDUW Plant and Apparatus** or **DC Connected Power Park Module**) or **HVDC System** is connected at 132kV and below. This will permit **Discrimination** between the **Generator** in respect of **OTSDUW Plant and Apparatus** or **DC Connected Power Park Modules** or **HVDC System Owners' Back-Up Protection** or **Independent Back-Up Protection** and the **Back-Up Protection** provided on the **National Electricity Transmission System** and other **Users' Systems**.

(c) When the **Power Generating Module** (other than **Power Park Units**), or the **HVDC Equipment** or **OTSDUW Plant and Apparatus** is connected to the **National Electricity Transmission System** at 400kV or 275kV, and in Scotland and **Offshore** also at 132kV, and a circuit breaker is provided by the **Generator** (including in respect of **OTSDUW Plant and Apparatus** or **DC Connected Power Park Modules**) or the **HVDC System** owner, or **NGET**, as the case may be, to interrupt fault current interchange with the **National Electricity Transmission System**, or **Generator's System**, or **HVDC System Owner's System**, as the case may be, circuit breaker fail **Protection** shall be provided by the **Generator** (including in respect of **OTSDUW Plant and Apparatus** or **DC Connected Power Park Modules**) or **HVDC System Owner**, or **NGET**, as the case may be, on this circuit breaker. In the event, following operation of a **Protection** system, of a failure to interrupt fault current by these circuit-breakers within the **Fault Current Interruption Time**, the circuit breaker fail **Protection** is required to initiate tripping of all the necessary electrically adjacent circuit-breakers so as to interrupt the fault current within the next 200ms.

(d) The target performance for the **System Fault Dependability Index** shall be not less than 99%. This is a measure of the ability of **Protection** to initiate successful tripping of circuit breakers which are associated with the faulty item of **Apparatus**.

ECC.6.2.2.3 Equipment including Protection equipment to be provided

NGET shall specify the **Protection** schemes and settings necessary to protect the **National Electricity Transmission System**, taking into account the characteristics of the **Power Generating Module** or **HVDC Equipment**.

The protection schemes needed for the **Power Generating Module** or **HVDC Equipment** and the **National Electricity Transmission System** as well as the settings relevant to the **Power Generating Module** and/or **HVDC Equipment** shall be coordinated and agreed between **NGET** and the **EU Generator** or **HVDC System Owner**. The agreed **Protection** schemes and settings will be specified in the **Bilateral Agreement**.

The protection schemes and settings for internal electrical faults must not prevent the **Power Generating Module** or **HVDC Equipment** from satisfying the requirements of the **Grid Code** although **EU Generators** should be aware of the requirements of **ECC.6.3.13.1** ;

electrical **Protection** of the **Power Generating Module** or **HVDC Equipment** shall take precedence over operational controls, taking into account the security of the **National Electricity Transmission System** and the health and safety of personnel, as well as mitigating any damage to the **Power Generating Module** or **HVDC Equipment**.

ECC.6.2.2.3.1 Protection of Interconnecting Connections

The requirements for the provision of **Protection** equipment for interconnecting connections will be specified in the **Bilateral Agreement**. In this ECC the term "interconnecting connections" means the primary conductors from the current transformer accommodation on the circuit side of the circuit breaker to the **Connection Point** or the primary conductors from the current transformer accommodation on the circuit side of the **OTSDUW Plant and Apparatus** of the circuit breaker to the **Transmission Interface Point**.

ECC.6.2.2.3.2 Circuit-breaker fail Protection

The **EU Generator** or **HVDC System Owner** will install circuit breaker fail **Protection** equipment in accordance with the requirements of the **Bilateral Agreement**. The **EU Generator** or **HVDC System Owner** will also provide a back-trip signal in the event of loss of air from its pressurised head circuit breakers, during the **Power Generating Module** (other than a **CCGT Unit** or **Power Park Unit**) or **HVDC Equipment** run-up sequence, where these circuit breakers are installed.

ECC.6.2.2.3.3 Loss of Excitation

The **EU Generator** must provide **Protection** to detect loss of excitation in respect of each of its **Generating Units** within a **Synchronous Power Generating Module** to initiate a **Generating Unit** trip.

ECC.6.2.2.3.4 Pole-Slipping Protection

Where, in **NGET's** reasonable opinion, **System** requirements dictate, **NGET** will specify in the **Bilateral Agreement** a requirement for **EU Generators** to fit pole-slipping **Protection** on their **Generating Units** within each **Synchronous Power Generating Module**.

ECC.6.2.2.3.5 Signals for Tariff Metering

EU Generators and **HVDC System Owners** will install current and voltage transformers supplying all tariff meters at a voltage to be specified in, and in accordance with, the **Bilateral Agreement**.

ECC.6.2.2.3.6 Commissioning of Protection Systems

No **EU Generator** or **HVDC System Owner** equipment shall be energised until the **Protection** settings have been finalised. The **EU Generator** or **HVDC System Owner** shall agree with **NGET** (in coordination with the **Relevant Transmission Licensee**) and carry out a combined commissioning programme for the **Protection** systems, and generally, to a minimum standard as specified in the **Bilateral Agreement**.

ECC.6.2.2.4 Work on Protection Equipment

No busbar **Protection**, mesh corner **Protection**, circuit-breaker fail **Protection** relays, AC or DC wiring (other than power supplies or DC tripping associated with the **Power Generating Module**, **HVDC Equipment** itself) may be worked upon or altered by the **EU Generator** or **HVDC System Owner** personnel in the absence of a representative of **NGET** or in Scotland or **Offshore**, a representative of **NGET**, or written authority from **NGET** to perform such work or alterations in the absence of a representative of **NGET**.

ECC.6.2.2.5 Relay Settings

Protection and relay settings will be co-ordinated (both on connection and subsequently) across the **Connection Point** in accordance with the **Bilateral Agreement** and in relation to **OTSDUW Plant and Apparatus**, across the **Interface Point** in accordance with the **Bilateral Agreement** to ensure effective disconnection of faulty **Apparatus**.

ECC.6.2.2.6 Changes to Protection Schemes and HVDC System Control Modes

ECC.6.2.2.6.1 Any subsequent alterations to the protection settings (whether by **NGET**, the **Relevant Transmission Licensee**, the **EU Generator** or the **HVDC System Owner**) shall be agreed between **NGET** (in co-ordination with the **Relevant Transmission Licensee**) and the **EU Generator** or **HVDC System Owner** in accordance with the Grid Code (ECC.6.2.2.5). No alterations are to be made to any protection schemes unless agreement has been reached between **NGET**, the **Relevant Transmission Licensee**, the **EU Generator** or **HVDC System Owner**.

ECC.6.2.2.6.2 The parameters of different control modes of the **HVDC System** shall be able to be changed in the **HVDC Converter Station**, if required by **NGET** in coordination with the **Relevant Transmission Licensee** and in accordance with ECC.6.2.2.6.4.

ECC.6.2.2.6.3 Any change to the schemes or settings of parameters of the different control modes and protection of the **HVDC System** including the procedure shall be agreed with **NGET** in coordination with the **Relevant Transmission Licensee** and the **HVDC System Owner**.

ECC.6.2.2.6.4 The control modes and associated set points shall be capable of being changed remotely, as specified by **NGET** in coordination with the **Relevant Transmission Licensee**.

ECC.6.2.2.7 Control Schemes and Settings

ECC.6.2.2.7.1 The schemes and settings of the different control devices on the **Power Generating Module** and **HVDC Equipment** that are necessary for **Transmission System** stability and for taking emergency action shall be agreed with **NGET** in coordination with the **Relevant Transmission Licensee** and the **EU Generator** or **HVDC System Owner**.

ECC.6.2.2.7.2 Subject to the requirements of ECC.6.2.2.7.1 any changes to the schemes and settings, defined in ECC.6.2.2.7.1, of the different control devices of the **Power Generating Module** or **HVDC Equipment** shall be coordinated and agreed between **NGET**, the **Relevant Transmission Licensee**, the **EU Generator** and **HVDC System Owner**.

ECC.6.2.2.8 Ranking of Protection and Control

ECC.6.2.2.8.1 **NGET** in coordination with **Relevant Transmission Licensees**, shall agree and coordinate the protection and control devices of **EU Generators Plant** and **Apparatus** in accordance with the following general priority ranking (from highest to lowest):

- (i) The interface between the **National Electricity Transmission System** and the **Power Generating Module** or **HVDC Equipment Protection** equipment;
- (ii) frequency control (active power adjustment);
- (iii) power restriction; and
- (iv) power gradient constraint;

ECC.6.2.2.8.2 A control scheme, specified by the **HVDC System Owner** consisting of different control modes, including the settings of the specific parameters, shall be coordinated and agreed between **NGET** in coordination with the **Relevant Transmission Licensee** and the **HVDC System Owner**. These details would be specified in the **Bilateral Agreement**.

ECC.6.2.2.8.3 **NGET** in coordination with **Relevant Transmission Licensees**, shall agree and coordinate the protection and control devices of **HVDC System Owners Plant** and **Apparatus** in accordance with the following general priority ranking (from highest to lowest)

- (i) The interface between the **National Electricity Transmission System** and **HVDC System Protection** equipment;
- (ii) **Active Power** control for emergency assistance
- (iii) automatic remedial actions as specified in ECC.6.3.6.1.2.5
- (iv) **Limited Frequency Sensitive Mode (LFSM)** of operation;
- (v) **Frequency Sensitive Mode** of operation and **Frequency** control; and
- (vi) power gradient constraint.

ECC.6.2.2.9 Synchronising

ECC.6.2.2.9.1 For any **Power Generating Module** directly connected to the **National Electricity Transmission System** or **Type D Power Generating Module**, synchronisation shall be performed by the **EU Generator** only after instruction by **NGET** in accordance with the requirements of BC.2.5.2.

ECC.6.2.2.9.2 Each **Power Generating Module** directly connected to the **National Electricity Transmission System** or **Type D Power Generating Module** shall be equipped with the necessary synchronisation facilities. Synchronisation shall be possible within the range of frequencies specified in ECC.6.1.2.

ECC.6.2.2.9.3 The requirements for synchronising equipment shall be specified in accordance with the requirements in the **Electrical Standards** listed in the annex to the **General Conditions**. The synchronisation settings shall include the following elements below. Any variation to these requirements shall be pursuant to the terms of the **Bilateral Agreement**.

- (a) voltage
- (b) **Frequency**
- (c) phase angle range
- (d) phase sequence
- (e) deviation of voltage and **Frequency**

ECC.6.2.2.9.4 **HVDC Equipment** shall be required to satisfy the requirements of ECC.6.2.2.9.1 – ECC.6.2.2.9.3. In addition, unless otherwise specified by **NGET**, during the synchronisation of a **DC Connected Power Park Module** to the **National Electricity Transmission System**, any **HVDC Equipment** shall have the capability to limit any steady state voltage changes to the limits specified within ECC.6.1.7 or ECC.6.1.8 (as applicable) which shall not exceed 5% of the pre-synchronisation voltage. **NGET** in coordination with the **Relevant Transmission Licensee** shall specify any additional requirements for the maximum magnitude, duration and measurement of the voltage transients over and above those defined in ECC.6.1.7 and ECC.6.1.8 in the **Bilateral Agreement**.

ECC.6.2.2.9.5 **EU Generators** in respect of **DC Connected Power Park Modules** shall also provide output synchronisation signals specified by **NGET** in co-ordination with the **Relevant Transmission Licensee**.

ECC.6.2.2.9.6 In addition to the requirements of ECC.6.2.2.9.1 to ECC.6.2.2.9.5, **EU Generators** and **HVDC System Owners** should also be aware of the requirements of ECC.6.5.10 relating to busbar voltage

ECC.6.2.2.9.10 HVDC Parameters and Settings

ECC.6.2.2.9.10.1 The parameters and settings of the main control functions of an **HVDC System** shall be agreed between the **HVDC System** owner and **NGET**, in coordination with the **Relevant Transmission Licensee**. The parameters and settings shall be implemented within such a control hierarchy that makes their modification possible if necessary. Those main control functions are at least:

- (b) **Frequency Sensitive Modes** (FSM, LFSM-O, LFSM-U);
- (c) **Frequency** control, if applicable;
- (d) **Reactive Power** control mode, if applicable;
- (e) power oscillation damping capability;
- (f) subsynchronous torsional interaction damping capability,.

ECC.6.2.2.11 Automatic Reconnection

ECC.6.2.2.11.1 **EU Generators** in respect of **Type A, Type B, Type C** and **Type D Power Generating Modules** (including **DC Connected Power Park Modules**) which have signed a **CUSC Contract** with **NGET** are not permitted to automatically reconnect to the **Total System** without instruction from **NGET**. **NGET** will issue instructions for re-connection or re-synchronisation in accordance with the requirements of BC2.5.2. Where synchronising is permitted in accordance with BC2.5.2, the voltage and frequency at the **Grid Entry Point** or **User System Entry Point** shall be within the limits defined in ECC.6.1.2 and ECC.6.1.4 and the ramp rate limits pursuant to BC1.A.1.1. For the avoidance of doubt this requirement does not apply to **EU Generators** who are not required to satisfy the requirements of the **Balancing Codes**.

ECC.6.2.2.12 Automatic Disconnection

ECC.6.2.2.12.1 No **Power Generating Module** or **HVDC Equipment** shall disconnect within the frequency range or voltage range defined in ECC.6.1.2 and ECC.6.1.4.

ECC.6.2.2.13 Special Provisions relating to Power Generating Modules embedded within Industrial Sites which supply electricity as a bi-product of their industrial process

ECC.6.2.2.13.1 **Generators** in respect of **Power Generating Modules** which form part of an industrial network, where the **Power Generating Module** is used to supply critical loads within the industrial process shall be permitted to operate isolated from the **Total System** if agreed with **NGET** in the **Bilateral Agreement**.

ECC.6.2.2.13.2 Except for the requirements of ECC.6.3.3 and ECC.6.3.7.1, **Power Generating Modules** which are embedded within industrial sites are not required to satisfy the requirements of ECC.6.3.6.2.1 and ECC.6.3.9. In this case this exception would only apply to **Power Generating Modules** on industrial sites used for combined heat and power production which are embedded in the network of an industrial site where all the following criteria are met.

- (a) The primary purpose of these sites is to produce heat for production processes of the industrial site concerned,
- (b) Heat and power generation is inextricably interlinked, that is to say any change to heat generation results inadvertently in a change of active power generating and visa versa.
- (c) The **Power Generating Modules** are of **Type A, Type B** or **Type C**.

(d) Combined heat and power generating facilities shall be assessed on the basis of their electrical **Maximum Capacity**.

ECC.6.2.3 Requirements at **EU Grid Supply Connection** Points relating to Network Operators and Non-Embedded Customers

Formatted: Font: Not Bold

ECC.6.2.3.1 Protection Arrangements for **EU Code User**'s in respect of Network Operators and Non-Embedded Customers

Formatted: Font: Not Bold

ECC.6.2.3.1.1 **Protection** arrangements for **EU Code User**'s in respect of **Network Operator**'s and **Non-Embedded Customer**'s **User Systems** directly connected to the **National Electricity Transmission System**, shall meet the requirements given below:

Formatted: Font: Not Bold

Formatted: Font: Not Bold

Fault Clearance Times

(a) The required fault clearance time for faults on **Network Operator** and **Non-Embedded Customer** equipment directly connected to the **National Electricity Transmission System**, and for faults on the **National Electricity Transmission System** directly connected to the **Network Operator**'s or **Non-Embedded Customer**'s equipment, from fault inception to the circuit breaker arc extinction, shall be set out in each **Bilateral Agreement**. The fault clearance time specified in the **Bilateral Agreement** shall not be shorter than the durations specified below:

- (i) 80ms at 400kV
- (ii) 100ms at 275kV
- (iii) 120ms at 132kV and below

but this shall not prevent the **User** or **NGET** or **Relevant Transmission Licensee** from selecting a shorter fault clearance time on its own **Plant** and **Apparatus** provided **Discrimination** is achieved.

For the purpose of establishing the **Protection** requirements in accordance with ECC.6.2.3.1.1 only, the point of connection of the **Network Operator** or **Non-Embedded Customer** equipment to the **National Electricity Transmission System** shall be deemed to be the low voltage busbars at an **EU Grid Supply Point**, irrespective of the ownership of the equipment at the **EU Grid Supply Point**.

Formatted: Font: Bold

Formatted: Font: Bold

A longer fault clearance time may be specified in the **Bilateral Agreement** for faults on the **National Electricity Transmission System**. A longer fault clearance time for faults on the **Network Operator** and **Non-Embedded Customers** equipment may be agreed with **NGET** in accordance with the terms of the **Bilateral Agreement** but only if **System** requirements in **NGET**'s view permit. The probability that the fault clearance time stated in the **Bilateral Agreement** will be exceeded by any given fault must be less than 2%.

- (b) (i) For the event of failure of the **Protection** systems provided to meet the above fault clearance time requirements, **Back-Up Protection** shall be provided by the **Network Operator** or **Non-Embedded Customer** as the case may be.
- (ii) **NGET** will also provide **Back-Up Protection**, which will result in a fault clearance time longer than that specified for the **Network Operator** or **Non-Embedded Customer Back-Up Protection** so as to provide **Discrimination**.
- (iii) For connections with the **National Electricity Transmission System** at 132kV and

below, it is normally required that the **Back-Up Protection** on the **National Electricity Transmission System** shall discriminate with the **Network Operator** or **Non-Embedded Customer's Back-Up Protection**.

- (iv) For connections with the **National Electricity Transmission System** at 400kV or 275kV, the **Back-Up Protection** will be provided by the **Network Operator** or **Non-Embedded Customer**, as the case may be, with a fault clearance time not longer than 300ms for faults on the **Network Operator's** or **Non-Embedded Customer's Apparatus**.
 - (v) Such **Protection** will also be required to withstand, without tripping, the loading incurred during the clearance of a fault on the **National Electricity Transmission System** by breaker fail **Protection** at 400kV or 275kV. This will permit **Discrimination** between **Network Operator's Back-Up Protection** or **Non-Embedded Customer's Back-Up Protection**, as the case may be, and **Back-Up Protection** provided on the **National Electricity Transmission System** and other **User Systems**. The requirement for and level of **Discrimination** required will be specified in the **Bilateral Agreement**.
- (c) (i) Where the **Network Operator** or **Non-Embedded Customer** is connected to the **National Electricity Transmission System** at 400kV or 275kV, and in Scotland also at 132kV, and a circuit breaker is provided by the **Network Operator** or **Non-Embedded Customer**, or **NGET**, as the case may be, to interrupt the interchange of fault current with the **National Electricity Transmission System** or the **System** of the **Network Operator** or **Non-Embedded Customer**, as the case may be, circuit breaker fail **Protection** will be provided by the **Network Operator** or **Non-Embedded Customer**, or **NGET**, as the case may be, on this circuit breaker.
- (ii) In the event, following operation of a **Protection** system, of a failure to interrupt fault current by these circuit-breakers within the **Fault Current Interruption Time**, the circuit breaker fail **Protection** is required to initiate tripping of all the necessary electrically adjacent circuit-breakers so as to interrupt the fault current within the next 200ms.
- (d) The target performance for the **System Fault Dependability Index** shall be not less than 99%. This is a measure of the ability of **Protection** to initiate successful tripping of circuit breakers which are associated with the faulty items of **Apparatus**.

ECC.6.2.3.2 Fault Disconnection Facilities

- (a) Where no **Transmission** circuit breaker is provided at the **User's** connection voltage, the **User** must provide **NGET** with the means of tripping all the **User's** circuit breakers necessary to isolate faults or **System** abnormalities on the **National Electricity Transmission System**. In these circumstances, for faults on the **User's System**, the **User's Protection** should also trip higher voltage **Transmission** circuit breakers. These tripping facilities shall be in accordance with the requirements specified in the **Bilateral Agreement**.
- (b) **NGET** may require the installation of a **System to Generator Operational Intertipping Scheme** in order to enable the timely restoration of circuits following power **System** fault(s). These requirements shall be set out in the relevant **Bilateral Agreement**.

ECC.6.2.3.3 Automatic Switching Equipment

Where automatic reclosure of **Transmission** circuit breakers is required following faults on the **User's System**, automatic switching equipment shall be provided in accordance with the requirements specified in the **Bilateral Agreement**.

ECC.6.2.3.4 Relay Settings

Protection and relay settings will be co-ordinated (both on connection and subsequently) across the **Connection Point** in accordance with the **Bilateral Agreement** to ensure effective disconnection of faulty **Apparatus**.

ECC.6.2.3.5 Work on Protection equipment

Where a **Transmission Licensee** owns the busbar at the **Connection Point**, no busbar **Protection**, mesh corner **Protection** relays, AC or DC wiring (other than power supplies or DC tripping associated with the **Network Operator** or **Non-Embedded Customer's Apparatus** itself) may be worked upon or altered by the **Network Operator** or **Non-Embedded Customer** personnel in the absence of a representative of **NGET** or in Scotland, a representative of **NGET**, or written authority from **NGET** to perform such work or alterations in the absence of a representative of **NGET**.

ECC.6.2.3.6 Equipment including Protection equipment to be provided

NGET in coordination with the **Relevant Transmission Licensee** shall specify and agree the **Protection** schemes and settings at each **EU Grid Supply Point** required to protect the **National Electricity Transmission System** in accordance with the characteristics of the **Network Operator's or Non Embedded Customer's System**. **NGET** in coordination with the **Relevant Transmission Licensee** and the **Network Operator** or **Non Embedded Customer** shall agree on the protection schemes and settings in respect of the busbar protection zone in respect of each **EU Grid Supply Point**.

Protection of the **Network Operator's or Non Embedded Customer's System** shall take precedence over operational controls whilst respecting the security of the **National Electricity Transmission System** and the health and safety of staff and the public.

ECC.6.2.3.6.1 Protection of Interconnecting Connections

The requirements for the provision of **Protection** equipment for interconnecting connections will be specified in the **Bilateral Agreement**.

ECC.6.2.3.7 Changes to Protection Schemes at EU Grid Supply Points

Any subsequent alterations to the busbar protection settings at the **EU Grid Supply Point**

Formatted: Font: Bold

Formatted: Font: Not Bold

Formatted: Font: Not Bold

Formatted: Font: Bold

Formatted: Font: Not Bold

Formatted: Font: Not Bold

Formatted: Font: Bold

Formatted: Font: Bold

(whether by **NGET**, the **Relevant Transmission Licensee**, the **Network Operator** or the **Non Embedded Customer**) shall be agreed between **NGET** (in co-ordination with the **Relevant Transmission Licensee**) and the **Network Operator** or **Non Embedded Customer** in accordance with the Grid Code (ECC.6.2.3.4). No alterations are to be made to any busbar protection schemes unless agreement has been reached between **NGET**, the **Relevant Transmission Licensee**, the **Network Operator** or **Non Embedded Customer**.

No **Network Operator** or **Non Embedded Customer** equipment shall be energised until the **Protection** settings have been agreed prior to commissioning finalised. The **Network Operator** or **Non Embedded Customer** shall agree with **NGET** (in coordination with the **Relevant Transmission Licensee**) and carry out a combined commissioning programme for the **Protection** systems, and generally, to a minimum standard as specified in the **Bilateral Agreement**.

ECC.6.2.3.8 Control Requirements

ECC.6.2.3.8.1 **NGET** in coordination with the **Relevant Transmission Licensee** and the **Network Operator** or **Non Embedded Customer** shall agree on the control schemes and settings at each **EU Grid Supply Point** of the different control devices of the **Network Operator's** or **Non Embedded Customer's System** relevant for security of the **National Electricity Transmission System**. Such requirements would be pursuant to the terms of the **Bilateral Agreement** which shall also cover at least the following elements:

- (a) Isolated (**-National Electricity Transmission System**) operation;
- (b) Damping of oscillations;
- (c) Disturbances to the **National Electricity Transmission System**;
- (d) Automatic switching to emergency supply and restoration to normal topology;
- (e) Automatic circuit breaker re-closure (on 1-phase faults).

ECC.6.2.3.8.2 Subject to the requirements of ECC.6.2.3.8.1 any changes to the schemes and settings, defined in ECC.6.2.3.8.1 of the different control devices of the **Network Operator's** or **Non-Embedded Customer's System** at the **EU Grid Supply Point** shall be coordinated and agreed between **NGET**, the **Relevant Transmission Licensee**, the **Network Operator** or **Non Embedded Customer**.

ECC.6.2.3.9 Ranking of Protection and Control

ECC.6.2.3.9.1 The **Network Operator** or the **Non Embedded Customer** who owns or operates an **at each EU Grid Supply Point** shall set the **Protection** and control devices of its **System**, in compliance with the following priority ranking, organised in decreasing order of importance:

- (a) **National Electricity Transmission System Protection**;
- (b) **Protection** equipment at each **EU Grid Supply Point**;
- (c) **Frequency** control (**Active Power** adjustment);
- (d) **Power** restriction.

ECC.6.2.3.10 Synchronising

Formatted: Font: Bold

Formatted: Font: Not Bold

Formatted: Font: Not Bold

Formatted: Font: Not Bold

Formatted: Font: Not Bold

Formatted: Font: Not Bold

Formatted: Font: Bold

Formatted: Font: Bold

Formatted: Font: Bold

~~ECC.6.2.3.10.1 Each **Network Operator** or **Non Embedded Customer** at each **EU Grid Supply Point** directly connected to the **National Electricity Transmission System** shall be capable of synchronisation within the range of frequencies specified in ECC.6.1.2 unless otherwise agreed with **NGET**.~~

Formatted: Font: Bold

~~ECC.6.2.3.10.2 **NGET** and the **Network Operator** or **Non Embedded Customer** shall agree on the settings of the synchronisation equipment at each **EU Grid Supply Point** prior to the **Completion Date**. **NGET** and the relevant **Network Operator** or **Non-Embedded Customer** shall agree the synchronisation settings which shall include the following elements which shall be pursuant to the terms of the **Bilateral Agreement**.~~

Formatted: Font: Bold

~~(a) **Voltage**;~~

Formatted: Font: Bold

~~(b) **Frequency**;~~

Formatted: Font: Bold

~~(c) **phase angle range**;~~

Formatted: Font: Bold

~~(d) deviation of voltage and **Frequency**.~~

Formatted: Font: Bold

Formatted: Font: Not Bold

Formatted: Font: Not Bold

ECC.6.3 GENERAL POWER GENERATING MODULE, OTSDUW AND HVDC EQUIPMENT REQUIREMENTS

ECC.6.3.1 This section sets out the technical and design criteria and performance requirements for **Power Generating Modules** and **HVDC Equipment** (whether directly connected to the **National Electricity Transmission System** or **Embedded**) and (where provided in this section) **OTSDUW Plant and Apparatus** which each **Generator** or **HVDC System Owner** must ensure are complied with in relation to its **Power Generating Modules, HVDC Equipment** and **OTSDUW Plant and Apparatus**. References to **Power Generating Modules, HVDC Equipment** in this ECC.6.3 should be read accordingly.

Plant Performance Requirements

ECC.6.3.2 REACTIVE CAPABILITY

ECC.6.3.2.1 Reactive Capability for Type B Synchronous Power Generating Modules

ECC.6.3.2.1.1 When operating at **Maximum Capacity**, all **Type B Synchronous Power Generating Modules** must be capable of continuous operation at any points between the limits of **0.95 Power Factor** lagging and **0.95 Power Factor** leading at the **Grid Entry Point** or **User System Entry Point** unless otherwise agreed with **NGET** or relevant **Network Operator**. At **Active Power** output levels other than **Maximum Capacity**, all **Generating Units** within a **Type B Synchronous Power Generating Module** must be capable of continuous operation at any point between the **Reactive Power** capability limits identified on the **HV Generator Performance Chart** unless otherwise agreed with **NGET** or relevant **Network Operator**.

ECC.6.3.2.2 Reactive Capability for Type B Power Park Modules

ECC.6.3.2.2.1 When operating at **Maximum Capacity** all **Type B Power Park Modules** must be capable of continuous operation at any points between the limits of **0.95 Power Factor** lagging and **0.95 Power Factor** leading at the **Grid Entry Point** or **User System Entry Point** unless otherwise agreed with **NGET** or relevant **Network Operator**. At **Active Power** output levels other than **Maximum Capacity**, each **Power Park Module** must be capable of continuous operation at any point between the **Reactive Power** capability limits identified on the **HV Generator Performance Chart** unless otherwise agreed with **NGET** or **Network Operator**.

ECC.6.3.2.3 Reactive Capability for Type C and D Synchronous Power Generating Modules

ECC.6.3.2.3.1 In addition to meeting the requirements of ECC.6.3.2.3.2 – ECC.6.3.2.3.5, **EU Generators** which connect a **Type C** or **Type D Synchronous Power Generating Module(s)** to a **Non Embedded Customers System** or private network, may be required to meet additional reactive compensation requirements at the point of connection between the **System** and the **Non Embedded Customer** or private network where this is required for **System** reasons.

ECC.6.3.2.3.2 All **Type C** and **Type D Synchronous Power Generating Modules** shall be capable of satisfying the **Reactive Power** capability requirements at the **Grid Entry Point** or **User System Entry Point** as defined in Figure ECC.6.3.2.3 when operating at **Maximum Capacity**.

ECC.6.3.2.3.3 At **Active Power** output levels other than **Maximum Capacity**, all **Generating Units** within a **Synchronous Power Generating Module** must be capable of continuous operation at any point between the **Reactive Power** capability limit identified on the **HV Generator Performance Chart** at least down to the **Minimum Stable Operating Level**. At reduced **Active Power** output, **Reactive Power** supplied at the **Grid Entry Point** (or **User System Entry Point** if **Embedded**) shall correspond to the **HV Generator Performance Chart** of the **Synchronous Power Generating Module**, taking the auxiliary supplies and the **Active Power** and **Reactive Power** losses of the **Generating Unit** transformer or **Station Transformer** into account.

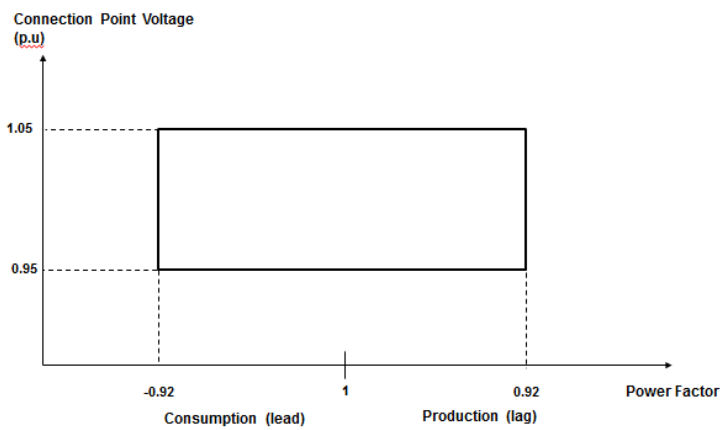

Figure ECC.6.3.2.3

ECC.6.3.2.3.4 In addition, to the requirements of ECC.6.3.2.3.1 – ECC.6.3.2.3.3 the short circuit ratio of all **Onshore Synchronous Generating Units** with an **Apparent Power** rating of less than 1600MVA shall not be less than 0.5. The short circuit ratio of **Onshore Synchronous Generating Units** with a rated **Apparent Power** of 1600MVA or above shall be not less than 0.4.

ECC.6.3.2.4 **Reactive Capability for Type C and D Power Park Modules, HVDC Equipment and OTSDUW Plant and Apparatus at the Interface Point**

ECC.6.3.2.4.1 EU Generators or HVDC System Owners which connect an Onshore Type C or Onshore Type D Power Park Module or HVDC Equipment to a Non Embedded Customers System or private network, may be required to meet additional reactive compensation requirements at the point of connection between the System and the Non Embedded Customer or private network where this is required for System reasons.

ECC.6.3.2.4.2 All Onshore Type C Power Park Modules and Onshore Type D Power Park Modules or HVDC Converters at an HVDC Converter Station with a Grid Entry Point or User System Entry Point voltage above 33kV, or Remote End HVDC Converters with an HVDC Interface Point voltage above 33kV, or OTSDUW Plant and Apparatus with an Interface Point voltage above 33kV shall be capable of satisfying the Reactive Power capability requirements at the Grid Entry Point or User System Entry Point (or Interface Point in the case of OTSDUW Plant and Apparatus, or HVDC Interface Point in the case of a Remote End HVDC Converter Station) as defined in Figure ECC.6.3.2.4(a) when operating at Maximum Capacity (or Interface Point Capacity in the case of OTSUW Plant and Apparatus). In the case of Remote End HVDC Converters and DC Connected Power Park Modules, NGET in co-ordination with the Relevant Transmission Licensee may agree to alternative reactive capability requirements to those specified in Figure ECC.6.3.2.4(a), where it is demonstrated that it is uneconomic and inefficient to do so, for example in the case of new technologies or advanced control strategies. For the avoidance of doubt, the requirements for Offshore Power Park Modules and DC Connected Power Park Modules are defined in ECC.6.3.2.5 and ECC.6.3.2.6.

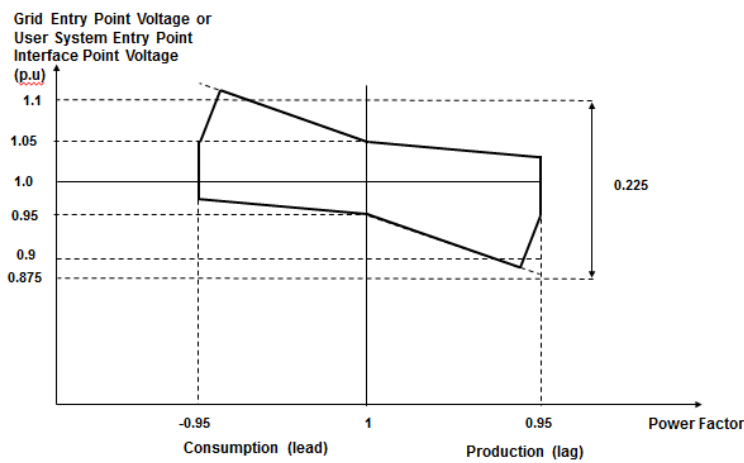

Figure ECC.6.3.2.4(a)

ECC.6.3.2.4.3 All Onshore Type C or Type D Power Park Modules or HVDC Converters at a HVDC Converter Station with a Grid Entry Point or User System Entry Point voltage at or below 33kV or Remote End HVDC Converter Station with an HVDC Interface Point Voltage at or below 33kV shall be capable of satisfying the Reactive Power capability requirements at the Grid Entry Point or User System Entry Point as defined in Figure ECC.6.3.2.4(b) when operating at Maximum Capacity. In the case of Remote End HVDC Converters NGET in co-ordination with the Relevant Transmission Licensee may agree to alternative reactive capability requirements to those specified in Figure ECC.6.3.2.4(b), where it is demonstrated that it is uneconomic and inefficient to do so, for example in the case of new technologies or advanced control strategies. For the avoidance of doubt, the requirements for Offshore Power Park Modules and DC Connected Power Park Modules are defined in ECC.6.3.2.5 and ECC.6.3.2.6.

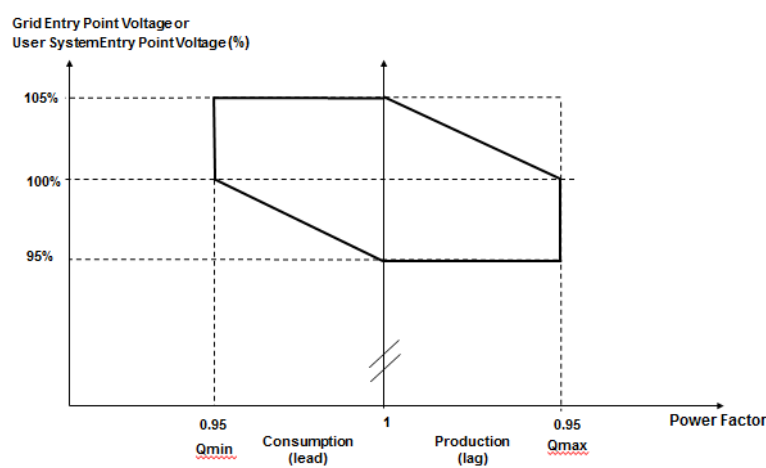

Figure ECC.6.3.2.4(a)

ECC.6.3.2.4.4 All Type C and Type D Power Park Modules, HVDC Converters at a HVDC Converter Station including Remote End HVDC Converters or OTSDUW Plant and Apparatus, shall be capable of satisfying the Reactive Power capability requirements at the Grid Entry Point or User System Entry Point (or Interface Point Capacity in the case of OTSUW Plant and Apparatus or HVDC Interface Point in the case of Remote End HVDC Converter Stations) as defined in Figure ECC.6.3.2.4(c) when operating below Maximum Capacity. With all Plant in service, the Reactive Power limits will reduce linearly below 50% Active Power output as shown in Figure ECC.6.3.2.4(c) unless the requirement to maintain the Reactive Power limits defined at Maximum Capacity (or Interface Point Capacity in the case of OTSDUW Plant and Apparatus) under absorbing Reactive Power conditions down to 20% Active Power output has been specified by NGET. These Reactive Power limits will be reduced pro rata to the amount of Plant in service. In the case of Remote End HVDC Converters, NGET in co-ordination with the Relevant Transmission Licensee may agree to alternative reactive capability requirements to those specified in Figure ECC.6.3.2.4(a), where it is demonstrated that it is uneconomic and inefficient to do so, for example in the case of new technologies or advanced control strategies. For the avoidance of doubt, the requirements for Offshore Power Park Modules and DC Connected Power Park Modules are defined in ECC.6.3.2.5 and ECC.6.3.2.6.

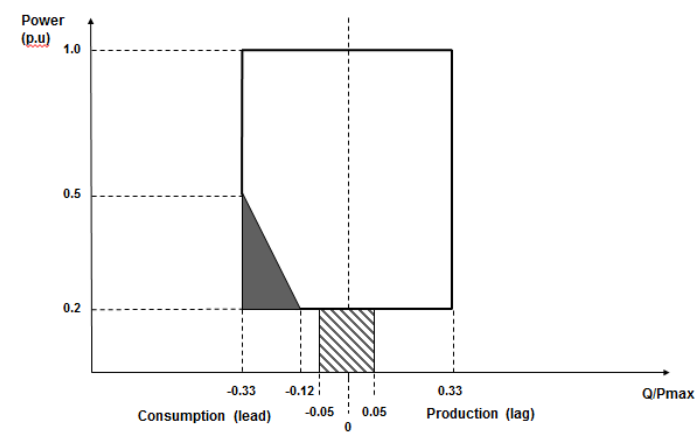

Figure ECC.6.3.2.4(c)

ECC.6.3.2.5 Reactive Capability for Offshore Synchronous Power Generating Modules, Configuration 1 AC connected Offshore Power Park Modules and Configuration 1 DC Connected Power Park Modules

ECC.6.3.2.5.1 The short circuit ratio of any Offshore Synchronous Generating Units within a Synchronous Power Generating Module shall not be less than 0.5. All Offshore Synchronous Generating Units, Configuration 1 AC connected Offshore Power Park Modules or Configuration 1 DC Connected Power Park Modules must be capable of maintaining zero transfer of Reactive Power at the Offshore Grid Entry Point. The steady state tolerance on Reactive Power transfer to and from an Offshore Transmission System expressed in MVAR shall be no greater than 5% of the Maximum Capacity.

ECC.6.3.2.5.2 For the avoidance of doubt if an EU Generator (including those in respect of DC Connected Power Park Modules) wishes to provide a Reactive Power capability in excess of the minimum requirements defined in ECC.6.3.2.5.1 then such capability (including steady state tolerance) shall be agreed between the Generator, Offshore Transmission Licensee and NGET and/or the relevant Network Operator.

ECC.6.3.2.6 Reactive Capability for Configuration 2 AC Connected Offshore Power Park Modules and Configuration 2 DC Connected Power Park Modules

ECC.6.3.2.6.1 All Configuration 2 AC connected Offshore Power Park Modules and Configuration 2 DC Connected Power Park Modules shall be capable of satisfying the minimum Reactive Power capability requirements at the Offshore Grid Entry Point as defined in Figure ECC.6.3.2.6(a) when operating at Maximum Capacity. NGET in co-ordination with the Relevant Transmission Licensee may agree to alternative reactive capability requirements to those specified in Figure ECC.6.3.2.6(a), where it is demonstrated that it is uneconomic and inefficient to do so, for example in the case of new technologies or advanced control strategies.

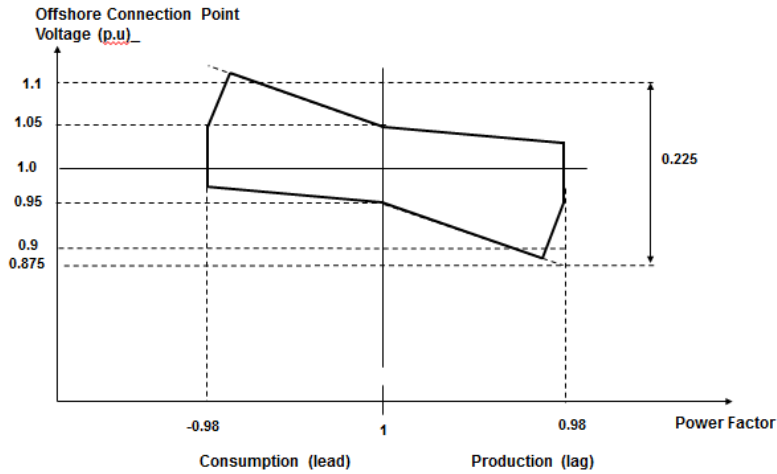

Figure ECC.6.3.2.6(a)

ECC.6.3.2.6.2 All AC Connected Configuration 2 Offshore Power Park Modules and Configuration 2 DC Connected Power Park Modules shall be capable of satisfying the Reactive Power capability requirements at the Offshore Grid Entry Point as defined in Figure ECC.6.3.2.6(b) when operating below Maximum Capacity. With all Plant in service, the Reactive Power limits will reduce linearly below 50% Active Power output as shown in Figure ECC.6.3.2.6(b) unless the requirement to maintain the Reactive Power limits defined at Maximum Capacity (or Interface Point Capacity in the case of OTSDUW Plant and Apparatus) under absorbing Reactive Power conditions down to 20% Active Power output has been specified with NGET. These Reactive Power limits will be reduced pro rata to the amount of Plant in service. NGET in co-ordination with the Relevant Transmission Licensee may agree to alternative reactive capability requirements to those specified in Figure ECC.6.3.2.6(b), where it is demonstrated that it is uneconomic and inefficient to do so, for example in the case of new technologies or advanced control strategies.

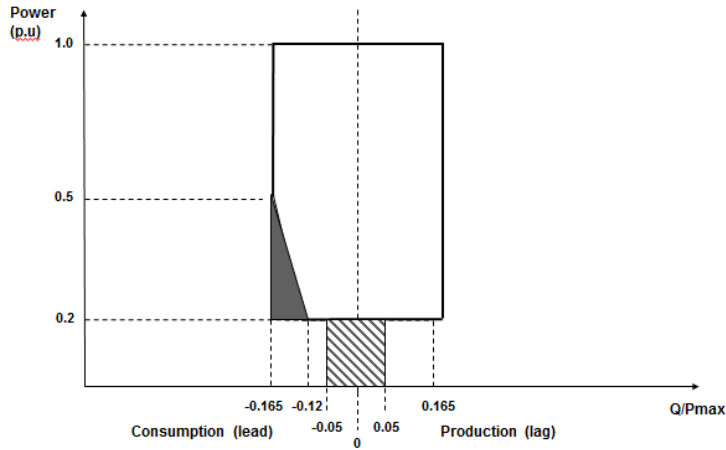

Figure ECC.6.3.2.6(b)

ECC.6.3.2.6.3 For the avoidance of doubt if an **EU Generator** (including **Generators** in respect of **DC Connected Power Park Modules** referred to in ECC.6.3.2.6.2) wishes to provide a **Reactive Power** capability in excess of the minimum requirements defined in ECC.6.3.2.6.1 then such capability (including any steady state tolerance) shall be between the **EU Generator**, **Offshore Transmission Licensee** and **NGET** and/or the relevant **Network Operator**.

ECC.6.3.3 OUTPUT POWER WITH FALLING FREQUENCY

ECC.6.3.3.1 Output power with falling frequency for Power Generating Modules and HVDC Equipment

CC.6.3.3.1.1 Each **Power Generating Module** and **HVDC Equipment** must be capable of:

- (a) continuously maintaining constant **Active Power** output for **System Frequency** changes within the range 50.5 to 49.5 Hz; and

(b) (subject to the provisions of ECC.6.1.2) maintaining its **Active Power** output at a level not lower than the figure determined by the linear relationship shown in Figure ECC.6.3.3(a) for **System Frequency** changes within the range 49.5 to 47 Hz for all ambient temperatures up to and including 25°C, such that if the **System Frequency** drops to 47 Hz the **Active Power** output does not decrease by more than 5%. In the case of a **CCGT Module**, the above requirement shall be retained down to the **Low Frequency Relay** trip setting of 48.8 Hz, which reflects the first stage of the Automatic **Low Frequency Demand Disconnection** scheme notified to **Network Operators** under OC6.6.2. For **System Frequency** below that setting, the existing requirement shall be retained for a minimum period of 5 minutes while **System Frequency** remains below that setting, and special measure(s) that may be required to meet this requirement shall be kept in service during this period. After that 5 minutes period, if **System Frequency** remains below that setting, the special measure(s) must be discontinued if there is a materially increased risk of the **Gas Turbine** tripping. The need for special measure(s) is linked to the inherent **Gas Turbine Active Power** output reduction caused by reduced shaft speed due to falling **System Frequency**. Where the need for special measures is identified in order to maintain output in line with the level identified in Figure ECC.6.3.3(a) these measures should be still continued at ambient temperatures above 25°C maintaining as much of the **Active Power** achievable within the capability of the plant.

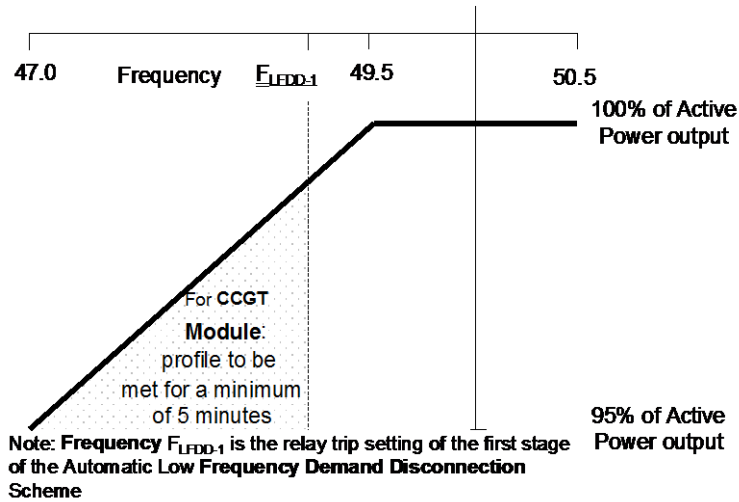

Figure ECC.6.3.3(a)

- (c) For the avoidance of doubt, in the case of a **Power Generating Module** including a **DC Connected Power Park Module** using an **Intermittent Power Source** where the mechanical power input will not be constant over time, the requirement is that the **Active Power** output shall be independent of **System Frequency** under (a) above and should not drop with **System Frequency** by greater than the amount specified in (b) above.
- (d) An **HVDC System** must be capable of maintaining its **Active Power** input (i.e. when operating in a mode analogous to **Demand**) from the **National Electricity Transmission System** (or **User System** in the case of an **Embedded HVDC System**) at a level not greater than the figure determined by the linear relationship shown in Figure ECC.6.3.3(b) for **System Frequency** changes within the range 49.5 to 47 Hz, such that if the **System Frequency** drops to 47.8 Hz the **Active Power** input decreases by more than 60%.

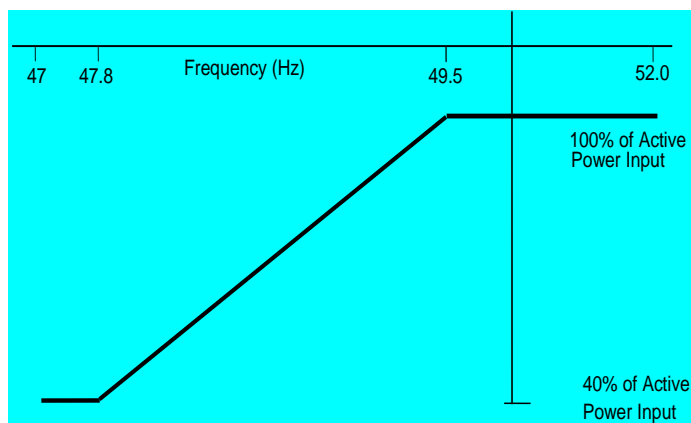

Figure ECC.6.3.3(b)

- (e) In the case of an **Offshore Generating Unit** or **Offshore Power Park Module** or **DC Connected Power Park Module** or **Remote End HVDC Converter** or **Transmission DC Converter**, the **EU Generator** shall comply with the requirements of ECC.6.3.3. **EU Generators** should be aware that Section K of the **STC** places requirements on **Offshore Transmission Licensees** which utilise a **Transmission DC Converter** as part of their **Offshore Transmission System** to make appropriate provisions to enable **EU Generators** to fulfil their obligations.
- (f) **Transmission DC Converters** and **Remote End HVDC Converters** shall provide a continuous signal indicating the real time frequency measured at the **Interface Point** to the **Offshore Grid Entry Point** or **HVDC Interface Point** for the purpose of **Offshore Generators** or **DC Connected Power Park Modules** to respond to changes in **System Frequency** on the Main Interconnected **Transmission System**. A **DC Connected Power Park Module** or **Offshore Power Generating Module** shall be capable of receiving and processing this signal within 100ms.

ECC.6.3.4 ACTIVE POWER OUTPUT UNDER SYSTEM VOLTAGE VARIATIONS

ECC.6.3.4.1 At the **Grid Entry Point** or **User System Entry Point**, the **Active Power** output under steady state conditions of any **Power Generating Module** or **HVDC Equipment** directly connected to the **National Electricity Transmission System** or in the case of **OTSDUW**, the **Active Power** transfer at the **Interface Point**, under steady state conditions of any **OTSDUW Plant and Apparatus** should not be affected by voltage changes in the normal operating range specified in paragraph ECC.6.1.4 by more than the change in **Active Power** losses at reduced or increased voltage.

ECC.6.3.5 BLACK START

ECC.6.3.5.1 **Black Start** is not a mandatory requirement, however **EU Code Users** may wish to notify **NGET** of their ability to provide a **Black Start** facility and the cost of the service. **NGET** will then consider whether it wishes to contract with the **EU Code User** for the provision of a **Black Start** service which would be specified via a **Black Start Contract**. Where an **EU Code User** does not offer to provide a cost for the provision of a **Black Start Capability**, **NGET** may make such a request if it considers **System** security to be at risk due to a lack of **Black Start** capability.

ECC.6.3.5.2 It is an essential requirement that the **National Electricity Transmission System** must incorporate a **Black Start Capability**. This will be achieved by agreeing a **Black Start Capability** at a number of strategically located **Power Stations** and **HVDC Systems**. For each **Power Station** or **HVDC System**, **NGET** will state in the **Bilateral Agreement** whether or not a **Black Start Capability** is required.

ECC.6.3.5.3 Where an **EU Code User** has entered into a **Black Start Contract** to provide a **Black Start Capability** in respect of a **Type C Power Generating Module** or **Type D Power Generating Module** (including **DC Connected Power Park Modules**) the following requirements shall apply.

- (i) The **Power-Generating Module** or **DC Connected Power Park Module** shall be capable of starting from shutdown without any external electrical energy supply within a time frame specified by **NGET** in the **Black Start Contract**.
- (ii) Each **Power Generating Module** or **DC Connected Power Park Module** shall be able to synchronise within the frequency limits defined in ECC.6.1. and, where applicable, voltage limits specified in ECC.6.1.4;

(iii) The **Power Generating Module** or **DC Connected Power Park Module** shall be capable of connecting on to an unenergised **System**.

(iv) The **Power-Generating Module** or **DC Connected Power Park Module** shall be capable of automatically regulating dips in voltage caused by connection of demand;

(v) The **Power Generating Module** or **DC Connected Power Park Module** shall:

be capable of **Block Load Capability**,

be capable of operating in **LFSM-O** and **LFSM-U**, as specified in ECC.6.3.7.1 and ECC.6.3.7.2

control **Frequency** in case of overfrequency and underfrequency within the whole **Active Power** output range between the **Minimum Regulating Level** and **Maximum Capacity** as well as at houseload operation levels

be capable of parallel operation of a few **Power Generating Modules** including **DC Connected Power Park Modules** within an isolated part of the **Total System** that is still supplying **Customers**, and control voltage automatically during the system restoration phase;

ECC.6.3.5.4 Each **HVDC System** or **Remote End HVDC Converter Station** which has a **Black Start Capability** shall be capable of energising the busbar of an AC substation to which another **HVDC Converter Station** is connected. The timeframe after shutdown of the **HVDC System** prior to energisation of the AC substation shall be pursuant to the terms of the **Black Start Contract**. The **HVDC System** shall be able to synchronise within the **Frequency** limits defined in ECC.6.1.2.1.2 and voltage limits defined in ECC.6.1.4.1 unless otherwise specified in the **Black Start Contract**. Wider **Frequency** and voltage ranges can be specified in the **Black Start Contract** in order to restore **System** security.

ECC.6.3.5.5 With regard to the capability to take part in operation of an isolated part of the **Total System** that is still supplying **Customers**:

(i) **Power Generating Modules** including **DC Connected Power Park Modules** shall be capable of taking part in island operation if specified in the **Black Start Contract** required by **NGET** and:

the **Frequency** limits for island operation shall be those specified in ECC.6.1.2,

the voltage limits for island operation shall be those defined in ECC.6.1.4;

(ii) **Power Generating Modules** including **DC Connected Power Park Modules** shall be able to operate in **Frequency Sensitive Mode** during island operation, as specified in ECC.6.3.7.3. In the event of a power surplus, **Power Generating Modules** including **DC Connected Power Park Modules** shall be capable of reducing the **Active Power** output from a previous operating point to any new operating point within the **Power Generating Module Performance Chart**. **Power Generating Modules** including **DC Connected Power Park Modules** shall be capable of reducing **Active Power** output as much as inherently technically feasible, but to at least 55 % of **Maximum Capacity**;

The method for detecting a change from interconnected system operation to island operation shall be agreed between the **EU Generator, NGET** and the **Relevant Transmission Licensee**. The agreed method of detection must not rely solely on **NGET, Relevant Transmission Licensee's** or **Network Operators** switchgear position signals;

- (iv) **Power Generating Modules** including **DC Connected Power Park Modules** shall be able to operate in **LFSM-O** and **LFSM-U** during island operation, as specified in **ECC.6.3.7.1** and **ECC.6.3.7.2**;

ECC.6.3.5.6 With regard to quick re-synchronisation capability:

- (i) In case of disconnection of the **Power Generating Module** including **DC Connected Power Park Modules** from the **System**, the **Power Generating Module** shall be capable of quick re-synchronisation in line with the **Protection** strategy agreed between **NGET** and/or **Network Operator** in co-ordination with the **Relevant Transmission Licensee** and the **Generator**;
- (ii) A **Power Generating Module** including a **DC Connected Power Park Module** with a minimum re-synchronisation time greater than 15 minutes after its disconnection from any external power supply must be capable of **Houseload Operation** from any operating point on its **Power Generating Module Performance Chart**. In this case, the identification of **Houseload Operation** must not be based solely on the **Total System's** switchgear position signals;
- (iii) **Power Generating Modules** including **DC Connected Power Park Modules** shall be capable of **Houseload Operation**, irrespective of any auxiliary connection to the **Total System**. The minimum operation time shall be specified by **NGET**, taking into consideration the specific characteristics of prime mover technology.

ECC.6.3.6 CONTROL ARRANGEMENTS

ECC.6.3.6.1 ACTIVE POWER CONTROL

ECC.6.3.6.1.1 Active Power control in respect of Power Generating Modules including DC Connected Power Park Modules

ECC.6.3.6.1.1.1 Type A Power Generating Modules shall be equipped with a logic interface (input port) in order to cease **Active Power** output within five seconds following receipt of a signal from **NGET**. **NGET** shall specify the requirements for such facilities, including the need for remote operation, in the **Bilateral Agreement** where they are necessary for **System** reasons

ECC.6.3.6.1.1.2 Type B Power Generating Modules shall be equipped with an interface (input port) in order to be able to reduce **Active Power** output following receipt of a signal from **NGET**. **NGET** shall specify the requirements for such facilities, including the need for remote operation, in the **Bilateral Agreement** where they are necessary for **System** reasons.

ECC.6.3.6.1.1.3 Type C and Type D Power Generating Modules and **DC Connected Power Park Modules** shall be capable of adjusting the **Active Power** setpoint in accordance with instructions issued by **NGET**.

ECC.6.3.6.1.2 Active Power control in respect of HVDC Systems and Remote End HVDC Converter Stations

ECC.6.3.6.1.2.1 HVDC Systems shall be capable of adjusting the transmitted Active Power upon receipt of an instruction from NGET which shall be in accordance with the requirements of BC2.6.1.

ECC.6.3.6.1.2.2 The requirements for fast Active Power reversal (if required) shall be specified by NGET. Where Active Power reversal is specified in the Bilateral Agreement, each HVDC System and Remote End HVDC Converter Station shall be capable of operating from maximum import to maximum export in a time which is as fast as technically feasible or in a time that is no greater than 2 seconds except where a HVDC Converter Station Owner has justified to NGET that a longer reversal time is required.

ECC.6.3.6.1.2.3 Where an HVDC System connects various Control Areas or Synchronous Areas, each HVDC System or Remote End HVDC Converter Station shall be capable of responding to instructions issued by NGET under the Balancing Code to modify the transmitted Active Power for the purposes of cross-border balancing.

ECC.6.3.6.1.2.4 An HVDC System shall be capable of adjusting the ramping rate of Active Power variations within its technical capabilities in accordance with instructions issued by NGET. In case of modification of Active Power according to ECC.6.3.15 and ECC.6.3.6.1.2.2, there shall be no adjustment of ramping rate.

ECC.6.3.6.1.2.5 If specified by NGET, in coordination with the Relevant Transmission Licensees, the control functions of an HVDC System shall be capable of taking automatic remedial actions including, but not limited to, stopping the ramping and blocking FSM, LFSM-O, LFSM-U and Frequency control. The triggering and blocking criteria shall be specified by NGET.

ECC.6.3.6.2 MODULATION OF ACTIVE POWER

ECC.6.3.6.2.1 Each Power Generating Module (including DC Connected Power Park Modules) and Onshore HVDC Converters at an Onshore HVDC Converter Station must be capable of contributing to Frequency control by continuous modulation of Active Power supplied to the National Electricity Transmission System. For the avoidance of doubt each Onshore HVDC Converter at an Onshore HVDC Converter Station and/or OTSDUW DC Converter shall provide each EU Code User in respect of its Offshore Power Stations connected to and/or using an Offshore Transmission System a continuous signal indicating the real time Frequency measured at the Transmission Interface Point. A DC Connected Power Park Module or Offshore Power Generating Module shall be capable of receiving and processing this signal within 100ms.

ECC.6.3.6.3 MODULATION OF REACTIVE POWER

ECC.6.3.6.3.1 Notwithstanding the requirements of ECC.6.3.2, each Power Generating Module or HVDC Equipment (and OTSDUW Plant and Apparatus at a Transmission Interface Point and Remote End HVDC Converter at an HVDC Interface Point) (as applicable) must be capable of contributing to voltage control by continuous changes to the Reactive Power supplied to the National Electricity Transmission System or the User System in which it is Embedded.

ECC.6.3.7 FREQUENCY RESPONSE

ECC.6.3.7.1 Limited Frequency Sensitive Mode – Overfrequency (LFSM-O)

ECC.6.3.7.1.1 Each **Power Generating Module** (including **DC Connected Power Park Modules**) and **HVDC Systems** shall be capable of reducing **Active Power** output in response to **Frequency** on the **Total System** when this rises above 50.4Hz. For the avoidance of doubt, the provision of this reduction in **Active Power** output is not an **Ancillary Service**. Such provision is known as **Limited High Frequency Response**. The **Power Generating Module** (including **DC Connected Power Park Modules**) or **HVDC Systems** shall be capable of operating stably during **LFSM-O** operation. However for a **Power Generating Module** (including **DC Connected Power Park Modules**) or **HVDC Systems** operating in **Frequency Sensitive Mode** the requirements of **LFSM-O** shall apply when the frequency exceeds 50.5Hz.

ECC.6.3.7.1.2 (i) The rate of change of **Active Power** output must be at a minimum a rate of 2 percent of output per 0.1 Hz deviation of **System Frequency** above 50.4Hz (ie a **Droop** of 10%) as shown in Figure ECC.6.3.7.1 below. This would not preclude a **EU Generator** or **HVDC System Owner** from designing their **Power Generating Module** with a **Droop** of less than 10% but in all cases the **Droop** should be 2% or greater..

(ii) The reduction in **Active Power** output must be continuously and linearly proportional, as far as is practicable, to the excess of **Frequency** above 50.4 Hz and must be provided increasingly with time over the period specified in (iii) below.

(iii) As much as possible of the proportional reduction in **Active Power** output must result from the frequency control device (or speed governor) action and must be achieved within 10 seconds of the time of the **Frequency** increase above 50.4 Hz. The **Power Generating Module** (including **DC Connected Power Park Modules**) or **HVDC Systems** shall be capable of initiating a power **Frequency** response with an initial delay that is as short as possible. If the delay exceeds 2 seconds the **EU Generator** or **HVDC System Owner** shall justify the delay, providing technical evidence to **NGET**.

(iv) The residue of the proportional reduction in **Active Power** output which results from automatic action of the **Power Generating Module** (including **DC Connected Power Park Modules**) or **HVDC System** output control devices other than the frequency control devices (or speed governors) must be achieved within 3 minutes for the time of the **Frequency** increase above 50.4Hz.

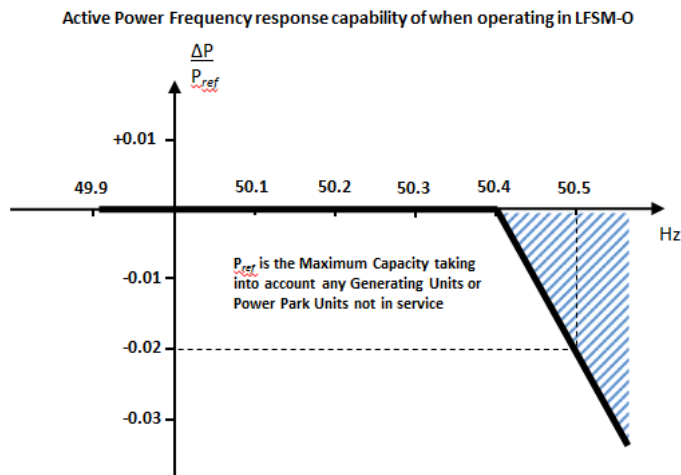

Figure ECC.6.3.7.1 – P_{ref} is the reference Active Power to which ΔP is related and ΔP is the change in Active Power output from the Power Generating Module (including DC Connected Power Park Modules) or HVDC System. The Power Generating Module (including DC Connected Power Park Modules or HVDC Systems) has to provide a negative Active Power output change with a droop of 10% or less based on P_{ref} .

ECC.6.3.7.1.3 Each Power Generating Module (including DC Connected Power Park Modules) or HVDC Systems which is providing Limited High Frequency Response (LFSM-O) must continue to provide it until the Frequency has returned to or below 50.4Hz or until otherwise instructed by NGET. EU Generators in respect of Gensets and HVDC Converter Station Owners in respect of an HVDC System should also be aware of the requirements in BC.3.7.2.2.

ECC.6.3.7.1.4 Steady state operation below the Minimum Stable Operating Level in the case of Power Generating Modules including DC Connected Power Park Modules or Minimum Active Power Transmission Capacity in the case of HVDC Systems is not expected but if System operating conditions cause operation below the Minimum Stable Operating Level or Minimum Active Power Transmission Capacity which could give rise to operational difficulties for the Power Generating Module including a DC Connected Power Park Module or HVDC Systems then the EU Generator or HVDC System Owner shall be able to return the output of the Power Generating Module including a DC Connected Power Park Module to an output of not less than the Minimum Stable Operating Level or HVDC System to an output of not less than the Minimum Active Power Transmission Capacity.

ECC.6.3.7.1.5 All reasonable efforts should in the event be made by the EU Generator or HVDC System Owner to avoid such tripping provided that the System Frequency is below 52Hz in accordance with the requirements of ECC.6.1.2. If the System Frequency is at or above 52Hz, the requirement to make all reasonable efforts to avoid tripping does not apply and the EU Generator or HVDC System Owner is required to take action to protect its Power Generating Modules including DC Connected Power Park Modules or HVDC Converter Stations

ECC.6.3.7.2 Limited Frequency Sensitive Mode – Underfrequency (LFSM-U)

ECC.6.3.7.2.1 Each **Type C Power Generating Module** and **Type D Power Generating Module** (including **DC Connected Power Park Modules**) or **HVDC Systems** operating in **Limited Frequency Sensitive Mode** shall be capable of increasing **Active Power** output in response to **System Frequency** when this falls below 49.5Hz. For the avoidance of doubt, the provision of this increase in **Active Power** output is not a mandatory **Ancillary Service** and it is not anticipated **Power Generating Modules** (including **DC Connected Power Park Modules**) or **HVDC Systems** are operated in an inefficient mode to facilitate delivery of **LFSM-U** response, but any inherent capability (where available) should be made without undue delay. The **Power Generating Module** (including **DC Connected Power Park Modules**) or **HVDC Systems** shall be capable of stable operation during **LFSM-U Mode**. For example, a **EU Generator** which is operating with no headroom (eg it is operating at maximum output or is de-loading as part of a run down sequence and has no headroom) would not be required to provide **LFSM-U**.

ECC.6.3.7.2.2 (i) The rate of change of **Active Power** output must be at a minimum rate of 2 percent of output per 0.1 Hz deviation of **System Frequency** below 49.5Hz (ie a **Droop** of 10%) as shown in Figure ECC.6.3.7.2.2 below. This requirement only applies if the **Power Generating Module** has headroom and the ability to increase **Active Power** output. In the case of a **Power Park Module** or **DC Connected Power Park Module** the requirements of Figure ECC.6.3.7.2.2 shall be reduced pro-rata to the amount of **Power Park Units** in service and available to generate. For the avoidance of doubt, this would not preclude an **EU Generator** or **HVDC System Owner** from designing their **Power Generating Module** with a lower **Droop** setting, for example between 3 – 5%.

(ii) As much as possible of the proportional increase in **Active Power** output must result from the **Frequency** control device (or speed governor) action and must be achieved for **Frequencies** below 49.5 Hz. The **Power Generating Module** (including **DC Connected Power Park Modules**) or **HVDC Systems** shall be capable of initiating a power **Frequency** response with minimal delay. If the delay exceeds 2 seconds the **EU Generator** or **HVDC System Owner** shall justify the delay, providing technical evidence to **NGET**.

(iii) The actual delivery of **Active Power Frequency Response** in **LFSM-U** mode shall take into account

The ambient conditions when the response is to be triggered

The operating conditions of the **Power Generating Module** (including **DC Connected Power Park Modules**) or **HVDC Systems** in particular limitations on operation near **Maximum Capacity** or **Maximum HVDC Active Power Transmission Capacity** at low frequencies and the respective impact of ambient conditions as detailed in ECC.6.3.3.

The availability of primary energy sources.

(iv) In **LFSM_U Mode**, the **Power Generating Module** (including **DC Connected Power Park Modules**) and **HVDC Systems**, shall be capable of providing a power increase up to its **Maximum Capacity** or **Maximum HVDC Active Power Transmission Capacity** (as applicable).

Active Power Frequency response capability of when operating in LFSM-U

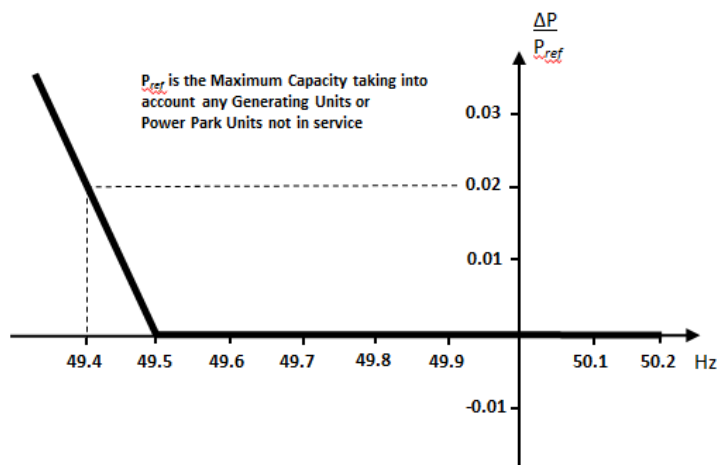

Figure ECC.6.3.7.2.2 – P_{ref} is the reference Active Power to which ΔP is related and ΔP is the change in Active Power output from the Power Generating Module (including DC Connected Power Park Modules) or HVDC System. The Power Generating Module (including DC Connected Power Park Modules or HVDC Systems) has to provide a positive Active Power output change with a droop of 10% or less based on Pref.

ECC.6.3.7.3 Frequency Sensitive Mode – (FSM)

ECC.6.3.7.3.1 In addition to the requirements of ECC.6.3.7.1 and ECC.6.3.7.2 each Type C Power Generating Module and Type D Power Generating Module (including DC Connected Power Park Modules) or HVDC Systems must be fitted with a fast acting proportional Frequency control device (or turbine speed governor) and unit load controller or equivalent control device to provide Frequency response under normal operational conditions in accordance with Balancing Code 3 (BC3). In the case of a Power Park Module including a DC Connected Power Park Module, the Frequency or speed control device(s) may be on the Power Park Module (including a DC Connected Power Park Module) or on each individual Power Park Unit (including a Power Park Unit within a DC Connected Power Park Module) or be a combination of both. The Frequency control device(s) (or speed governor(s)) must be designed and operated to the appropriate:

- (i) European Specification; or
- (ii) in the absence of a relevant European Specification, such other standard which is in common use within the European Community (which may include a manufacturer specification);

as at the time when the installation of which it forms part was designed or (in the case of modification or alteration to the Frequency control device (or turbine speed governor)) when the modification or alteration was designed.

The European Specification or other standard utilised in accordance with sub paragraph ECC.6.3.7.3.1 (a) (ii) will be notified to NGET by the EU Generator or HVDC System Owner:

- (i) as part of the application for a **Bilateral Agreement**; or
- (ii) as part of the application for a varied **Bilateral Agreement**; or
- (iii) in the case of an Embedded Development, within 28 days of entry into the Embedded Development Agreement (or such later time as agreed with NGET) or
- (iv) as soon as possible prior to any modification or alteration to the **Frequency control device** (or governor); and

ECC.6.3.7.3.2 The **Frequency control device** (or speed governor) in co-ordination with other control devices must control each **Type C Power Generating Module** and **Type D Power Generating Module** (including **DC Connected Power Park Modules**) or **HVDC Systems Active Power Output** or **Active Power** transfer capability with stability over the entire operating range of the **Power Generating Module** (including **DC Connected Power Park Modules**) or **HVDC Systems** ; and

ECC.6.3.7.3.3 **Type C and Type D Power Generating Modules** and **DC Connected Power Park Modules** shall also meet the following minimum requirements:

- (i) capable of providing **Active Power Frequency** response in accordance with the performance characteristic shown in Figure 6.3.7.3.3(a) and parameters in Table 6.3.7.3.3(a)

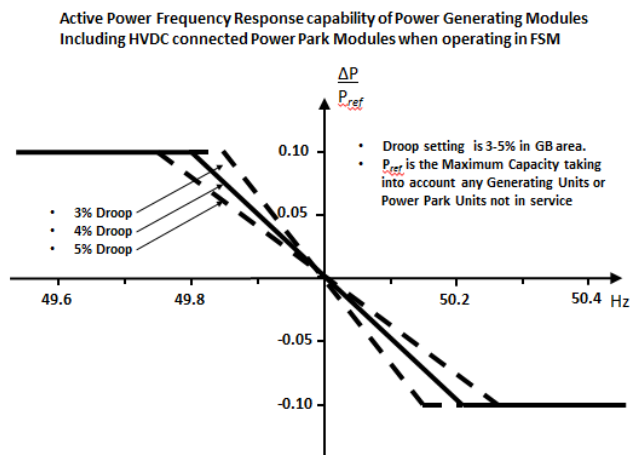

Figure 6.3.7.3.3(a) – **Frequency Sensitive Mode** capability of **Power Generating Modules** and **DC Connected Power Park Modules**

Parameter	Setting
Nominal System Frequency	50Hz
Active Power as a percentage of Maximum Capacity ($\frac{ \Delta P }{P_{max}}$)	10%
Frequency Response Insensitivity in mHz ($ \Delta f_i $)	±15mHz

Frequency Response Insensitivity as a percentage of nominal frequency ($\frac{\Delta f_{pl}}{f_n}$)	±0.03%
Frequency Response Deadband in mHz	0 (mHz)
Droop (%)	3 – 5%

Table 6.3.7.3.3(a) – Parameters for **Active Power Frequency** response in **Frequency Sensitive Mode** including the mathematical expressions in Figure 6.3.7.3.3(a).

(ii) In satisfying the performance requirements specified in ECC.6.3.7.3(i) **EU Generators** in respect of each **Type C** and **Type D Power Generating Modules and DC Connected Power Park Module** should be aware:-

in the case of overfrequency, the **Active Power Frequency** response is limited by the **Minimum Regulating Level**,

in the case of underfrequency, the **Active Power Frequency** response is limited by the **Maximum Capacity**,

the actual delivery of **Active Power** frequency response depends on the operating and ambient conditions of the **Power Generating Module** (including **DC Connected Power Park Modules**) when this response is triggered, in particular limitations on operation near **Maximum Capacity** at low **Frequencies** as specified in ECC.6.3.3 and available primary energy sources.

The frequency control device (or speed governor) must also be capable of being set so that it operates with an overall speed **Droop** of between 3 – 5%. The **Frequency Response Deadband** and **Droop** must be able to be reselected repeatedly. For the avoidance of doubt, in the case of a **Power Park Module** (including **DC Connected Power Park Modules**) the speed **Droop** should be equivalent of a fixed setting between 3% and 5% applied to each **Power Park Unit** in service.

(iii) In the event of a **Frequency** step change, each **Type C** and **Type D Power Generating Module** and **DC Connected Power Park Module** shall be capable of activating full and stable **Active Power Frequency** response (without undue power oscillations), in accordance with the performance characteristic shown in Figure 6.3.7.3.3(b) and parameters in Table 6.3.7.3.3(b).

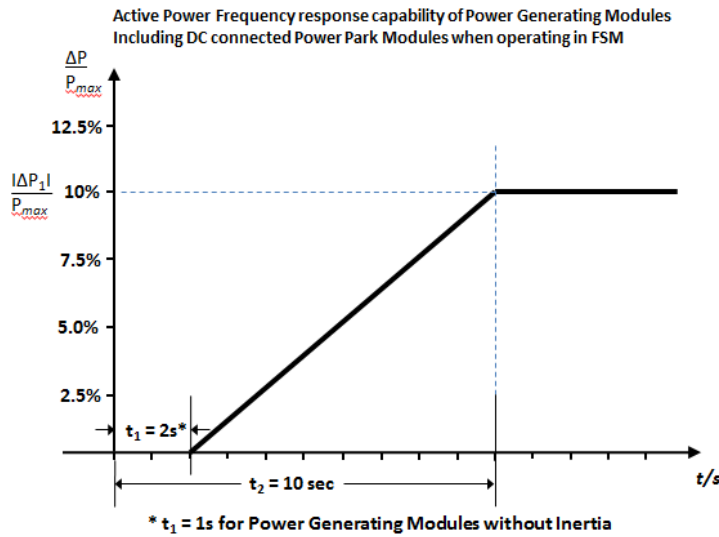

Figure 6.3.7.3.3(b) Active Power Frequency Response capability.

Parameter	Setting
Active Power as a percentage of Maximum Capacity (frequency response range) ($\frac{\Delta P_1}{P_{max}}$)	10%
Maximum admissible initial delay t_1 for Power Generating Modules (including DC Connected Power Park Modules) with inertia unless justified as specified in ECC.6.3.7.3.3 (iv)	2 seconds
Maximum admissible initial delay t_1 for Power Generating Modules (including DC Connected Power Park Modules) which do not contribute to System inertia unless justified as specified in ECC.6.3.7.3.3 (iv)	1 second
Activation time t_2	10 seconds

Table 6.3.7.3.3(b) – Parameters for full activation of Active Power Frequency response resulting from a Frequency step change. Table 6.3.7.3.3(b) also includes the mathematical expressions used in Figure 6.3.7.3.3(b).

- (iv) The initial activation of Active Power Primary Frequency response shall not be unduly delayed. For Type C and Type D Power Generating Modules (including DC Connected Power Park Modules) with inertia the delay in initial Active Power Frequency response shall not be greater than 2 seconds. For Type C and Type D Power Generating Modules (including DC Connected Power Park Modules) without inertia, the delay in initial Active Power Frequency response shall not be greater than 1 second. If the Generator cannot meet this requirement they shall provide technical evidence to NGET demonstrating why a longer time is needed for the initial activation of Active Power Frequency response.
- (v) in the case of Type C and Type D Power Generating Modules (including DC Connected Power Park Modules) other than the Steam Unit within a CCGT Module the combined effect of the Frequency Response Insensitivity and Frequency Response Deadband of the Frequency control device (or speed governor) should be no greater than 0.03Hz (for the avoidance of doubt, $\pm 0.015\text{Hz}$). In the case of the Steam Unit within a CCGT Module, the Frequency Response Deadband should be set to an appropriate value consistent with the requirements of ECC.6.3.7.3.5(ii) and the requirements of BC3.7.2.2 for the provision of LFSM-O taking account of any Frequency Response Insensitivity of the Frequency control device (or speed governor);

ECC.6.3.7.3.4 HVDC Systems shall also meet the following minimum requirements:

- (i) HVDC Systems shall be capable of responding to Frequency deviations in each connected AC System by adjusting their Active Power import or export as shown in Figure 6.3.7.3.4(a) with the corresponding parameters in Table 6.3.7.3.4(a).

Active Power Frequency response capability of HVDC systems when operating in FSI

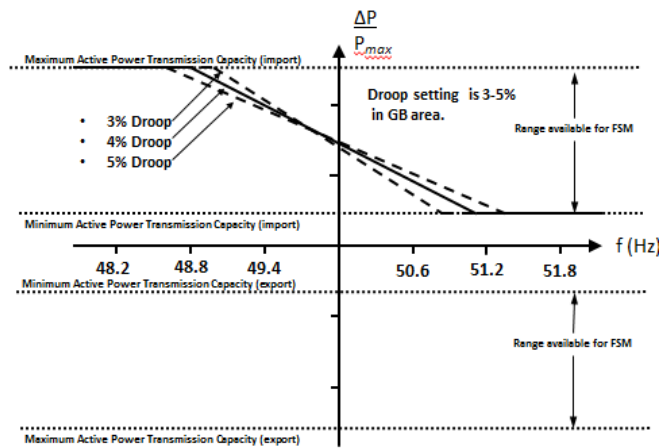

Figure 6.3.7.3.4(a) – Active Power frequency response capability of a HVDC System operating in Frequency Sensitive Mode (FSM). ΔP is the change in active power output from the HVDC System.

Parameter	Setting
Frequency Response Deadband	0
Droop S1 and S2 (upward and downward regulation) where S1=S2.	3 – 5%
Frequency Response Insensitivity	±15mHz

Table 6.3.7.3.4(a) – Parameters for Active Power Frequency response in FSM including the mathematical expressions in Figure 6.3.7.3.4.

(ii) Each HVDC System shall be capable of adjusting the Droop for both upward and downward regulation and the Active Power range over which Frequency Sensitive Mode of operation is available as defined in ECC.6.3.7.3.4.

(iii) In addition to the requirements in ECC.6.3.7.4(i) and ECC.6.3.7.4(ii) each HVDC System shall be capable of:-

delivering the response as soon as technically feasible

delivering the response on or above the solid line in Figure 6.3.7.3.4(b) in accordance with the parameters shown in Table 6.3.7.3.4(b)

initiating the delivery of Primary Response in no less than 0.5 seconds unless otherwise agreed with NGET. Where the initial delay time (t_1 – as shown in Figure 6.3.7.3.4(b)) is longer than 0.5 seconds the HVDC Converter Station Owner shall reasonably justify it to NGET.

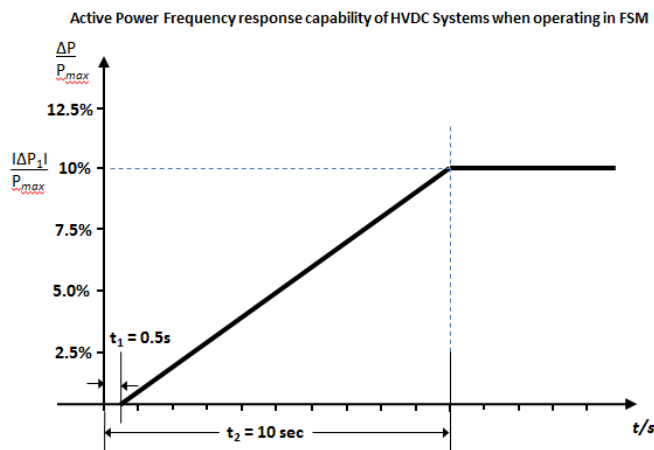

Figure 6.3.7.3.4(b) Active Power Frequency Response capability of a HVDC System. ΔP is the change in Active Power triggered by the step change in frequency

Parameter	Setting

Active Power as a percentage of Maximum Capacity (frequency response range) $\left(\frac{\Delta P_{\pm 1}}{P_{max}}\right)$	10%
Maximum admissible delay t_1	0.5 seconds
Maximum admissible time for full activation t_2 , unless longer activation times are agreed with NGET	10 seconds

Table 6.3.7.3.4(b) – Parameters for full activation of Active Power Frequency response resulting from a Frequency step change.

- (iv) For HVDC Systems connecting various Synchronous Areas, each HVDC System shall be capable of adjusting the full Active Power Frequency Response when operating in Frequency Sensitive Mode at any time and for a continuous time period. In addition, the Active Power controller of each HVDC System shall not have any adverse impact on the delivery of frequency response.
- ECC.6.3.7.3.5 For HVDC Systems and Type C and Type D Power Generating Modules (including DC Connected Power Park Modules), other than the Steam Unit within a CCGT Module the combined effect of the Frequency Response Insensitivity and Frequency Response Deadband of the Frequency control device (or speed governor) should be no greater than 0.03Hz (for the avoidance of doubt, $\pm 0.015\text{Hz}$). In the case of the Steam Unit within a CCGT Module, the Frequency Response Deadband should be set to an appropriate value consistent with the requirements of ECC.6.3.7.3.5(ii) and the requirements of BC3.7.2.2 for the provision of LFSM-O taking account of any Frequency Response Insensitivity of the Frequency control device (or speed governor);
- (i) With regard to disconnection due to underfrequency, EU Generators responsible for Type C and Type D Power Generating Modules (including DC Connected Power Park Modules) capable of acting as a load, including but not limited to Pumped Storage and tidal Power Generating Modules, HVDC Systems and Remote End HVDC Converter Stations, shall be capable of disconnecting their load in case of underfrequency which will be agreed with NGET. For the avoidance of doubt this requirement does not apply to station auxiliary supplies; EU Generators in respect of Type C and Type D Pumped Storage Power Generating Modules should also be aware of the requirements in OC.6.6.6.

(ii) Where a **Type C** or **Type D Power Generating Module**, **DC Connected Power Park Module** or **HVDC System** becomes isolated from the rest of the **Total System** but is still supplying **Customers**, the **Frequency** control device (or speed governor) must also be able to control **System Frequency** below 52Hz unless this causes the **Type C** or **Type D Power Generating Module** or **DC Connected Power Park Module** to operate below its **Minimum Regulating Level** or **Minimum Active Power Transmission Capacity** when it is possible that it may, as detailed in BC 3.7.3, trip after a time. For the avoidance of doubt **Power Generating Modules** (including **DC Connected Power Park Modules**) and **HVDC Systems** are only required to operate within the **System Frequency** range 47 - 52 Hz as defined in ECC.6.1.2 and for converter based technologies, the remaining island contains sufficient fault level for effective commutation;

(iii) Each **Type C** and **Type D Power Generating Module** and **HVDC Systems** shall have the facility to modify the **Target Frequency** setting either continuously or in a maximum of 0.05Hz steps over at least the range 50 ±0.1Hz should be provided in the unit load controller or equivalent device.

ECC.6.3.7.3.6 In addition to the requirements of ECC.6.3.7.3 each **Type C** and **Type D Power Generating Module** and **HVDC System** shall be capable of meeting the minimum **Frequency** response requirement profile subject to and in accordance with the provisions of Appendix A3.

ECC.6.3.7.3.7 For the avoidance of doubt, the requirements of Appendix A3 do not apply to **Type A** and **Type B Power Generating Modules**.

ECC.6.3.8 EXCITATION AND VOLTAGE CONTROL PERFORMANCE REQUIREMENTS

ECC.6.3.8.1 Excitation Performance Requirements for Type B Synchronous Power Generating Modules

ECC.6.3.8.1.1 Each **Synchronous Generating Unit** within a **Type B Synchronous Power Generating Module** shall be equipped with a permanent automatic excitation control system that shall have the capability to provide constant terminal voltage at a selectable setpoint without instability over the entire operating range of the **Type B Synchronous Power Generating Module**.

ECC.6.3.8.1.2 In addition to the requirements of ECC.6.3.8.1.1, **NGET** or the relevant **Network Operator** will specify if the control system of the **Type B Synchronous Power Generating Module** shall contribute to voltage control or **Reactive Power** control or **Power Factor** control at the **Grid Entry Point** or **User System Entry Point** (or other defined busbar). The performance requirements of the control system including slope (where applicable) shall be agreed between **NGET** and/or the relevant **Network Operator** and the **EU Generator**.

ECC.6.3.8.2 Voltage Control Requirements for Type B Power Park Modules

ECC.6.3.8.2.1 **NGET** or the relevant **Network Operator** will specify if the control system of the **Type B Power Park Module** shall contribute to voltage control or **Reactive Power** control or **Power Factor** control at the **Grid Entry Point** or **User System Entry Point** (or other defined busbar). The performance requirements of the control system including slope (where applicable) shall be agreed between **NGET** and/or the relevant **Network Operator** and the **EU Generator**.

- ECC.6.3.8.3 Excitation Performance Requirements for Type C and Type D Onshore Synchronous Power Generating Modules**
- ECC.6.3.8.3.1** Each **Synchronous Generating Unit** within a **Type C** and **Type D Onshore Synchronous Power Generating Modules** shall be equipped with a permanent automatic excitation control system that shall have the capability to provide constant terminal voltage control at a selectable setpoint without instability over the entire operating range of the **Synchronous Power Generating Module**.
- ECC.6.3.8.3.2** The requirements for excitation control facilities are specified in ECC.A.6. Any site specific requirements shall be specified by **NGET** or the relevant **Network Operator**.
- ECC.6.3.8.3.3** Unless otherwise required for testing in accordance with OC5.A.2, the automatic excitation control system of an **Onshore Synchronous Power Generating Module** shall always be operated such that it controls the **Onshore Synchronous Generating Unit** terminal voltage to a value that is
- equal to its rated value: or
 - only where provisions have been made in the **Bilateral Agreement**, greater than its rated value.
- ECC.6.3.8.3.4** In particular, other control facilities including constant **Reactive Power** output control modes and constant **Power Factor** control modes (but excluding VAR limiters) are not required. However if present in the excitation or voltage control system they will be disabled unless otherwise agreed with **NGET** or the relevant **Network Operator**. Operation of such control facilities will be in accordance with the provisions contained in **BC2**.
- ECC.6.3.8.3.5** The excitation performance requirements for **Offshore Synchronous Power Generating Modules** with an **Offshore Grid Entry Point** shall be specified by **NGET**.
- ECC.6.3.8.4 Voltage Control Performance Requirements for Type C and Type D Onshore Power Park Modules, Onshore HVDC Converters and OTSUW Plant and Apparatus at the Interface Point**

ECC.6.3.8.4.1 Each **Type C** and **Type D Onshore Power Park Module, Onshore HVDC Converter** and **OTSDUW Plant and Apparatus** shall be fitted with a continuously acting automatic control system to provide control of the voltage at the **Grid Entry Point** or **User System Entry Point** (or **Interface Point** in the case of **OTSDUW Plant and Apparatus**) without instability over the entire operating range of the **Onshore Power Park Module**, or **Onshore HVDC Converter** or **OTSDUW Plant and Apparatus**. Any **Plant** or **Apparatus** used in the provisions of such voltage control within an **Onshore Power Park Module** may be located at the **Power Park Unit** terminals, an appropriate intermediate busbar or the **Grid Entry Point** or **User System Entry Point**. In the case of an **Onshore HVDC Converter** at a **HVDC Converter Station** any **Plant** or **Apparatus** used in the provisions of such voltage control may be located at any point within the **User's Plant and Apparatus** including the **Grid Entry Point** or **User System Entry Point**. **OTSDUW Plant and Apparatus** used in the provision of such voltage control may be located at the **Offshore Grid Entry Point** an appropriate intermediate busbar or at the **Interface Point**. When operating below 20% **Maximum Capacity** the automatic control system may continue to provide voltage control using any available reactive capability. If voltage control is not being provided, the automatic control system shall be designed to ensure a smooth transition between the shaded area below 20% of **Active Power** output and the non-shaded area above 20% of **Active Power** output in Figure ECC.6.3.2.5(c) and Figure ECC.6.3.2.7(b) The performance requirements for a continuously acting automatic voltage control system that shall be complied with by the **User** in respect of **Onshore Power Park Modules, Onshore HVDC Converters** at an **Onshore HVDC Converter Station, OTSDUW Plant and Apparatus** at the **Interface Point** are defined in ECC.A.7.

ECC.6.3.8.4.3 In particular, other control facilities, including constant **Reactive Power** output control modes and constant **Power Factor** control modes (but excluding VAR limiters) are not required. However if present in the voltage control system they will be disabled unless otherwise agreed with **NGET** or the relevant **Network Operator**. Operation of such control facilities will be in accordance with the provisions contained in BC2. Where **Reactive Power** output control modes and constant **Power Factor** control modes have been fitted within the voltage control system they shall be required to satisfy the requirements of ECC.A.7.3 and ECC.A.7.4.

ECC.6.3.8.5 Excitation Control Performance requirements applicable to AC Connected Offshore Synchronous Power Generating Modules and voltage control performance requirements applicable to AC connected Offshore Power Park Modules, DC Connected Power Park Modules and Remote End HVDC Converters

ECC.6.3.8.5.1 A continuously acting automatic control system is required to provide control of **Reactive Power** (as specified in ECC.6.3.2.5 and ECC.6.3.2.6) at the **Offshore Grid Entry Point** (or **HVDC Interface Point** in the case of **Configuration 1 DC Connected Power Park Modules** and **Remote End HVDC Converters**) without instability over the entire operating range of the AC connected **Offshore Synchronous Power Generating Module** or **Configuration 1 AC connected Offshore Power Park Module** or **Configuration 1 DC Connected Power Park Modules** or **Remote End HVDC Converter**. The performance requirements for this automatic control system will be specified by **NGET** which would be consistent with the requirements of ECC.6.3.2.5 and ECC.6.3.2.6.

ECC.6.3.8.5.2 A continuously acting automatic control system is required to provide control of **Reactive Power** (as specified in ECC.6.3.2.8) at the **Offshore Grid Entry Point** (or **HVDC Interface Point** in the case of **Configuration 2 DC Connected Power Park Modules**) without instability over the entire operating range of the **Configuration 2 AC connected Offshore Power Park Module** or **Configuration 2 DC Connected Power Park Modules**. Otherwise the requirements of ECC.6.3.2.6 shall apply. The performance requirements for this automatic control system are specified in ECC.A.8

ECC.6.3.8.5.3 In addition to ECC.6.3.8.5.1 and ECC.6.3.8.5.2 the requirements for excitation or voltage control facilities, including **Power System Stabilisers**, where these are necessary for system reasons, will be specified by **NGET**. Reference is made to on-load commissioning witnessed by **NGET** in BC2.11.2.

ECC.6.3.9 STEADY STATE LOAD INACCURACIES

ECC.6.3.9.1 The standard deviation of **Load** error at steady state **Load** over a 30 minute period must not exceed 2.5 per cent of a **Type C** or **Type D Power Generating Modules** (including a **DC Connected Power Park Module**) **Maximum Capacity**. Where a **Type C** or **Type D Power Generating Module** (including a **DC Connected Power Park Module**) is instructed to **Frequency** sensitive operation, allowance will be made in determining whether there has been an error according to the governor droop characteristic registered under the **PC**.
For the avoidance of doubt in the case of a **Power Park Module** allowance will be made for the full variation of mechanical power output.

ECC.6.3.10 NEGATIVE PHASE SEQUENCE LOADINGS

ECC.6.3.10.1 In addition to meeting the conditions specified in ECC.6.1.5(b), each **Synchronous Power Generating Module** will be required to withstand, without tripping, the negative phase sequence loading incurred by clearance of a close-up phase-to-phase fault, by **System Back-Up Protection** on the **National Electricity Transmission System** or **User System** located **Onshore** in which it is **Embedded**.

ECC.6.3.11 NEUTRAL EARTHING

ECC.6.3.11 At nominal **System** voltages of 110kV and above the higher voltage windings of a transformer of a **Power Generating Module** or **HVDC Equipment** or transformer resulting from **OTSDUW** must be star connected with the star point suitable for connection to earth. The earthing and lower voltage winding arrangement shall be such as to ensure that the **Earth Fault Factor** requirement of paragraph ECC.6.2.1.1 (b) will be met on the **National Electricity Transmission System** at nominal **System** voltages of 110kV and above.

ECC.6.3.12 FREQUENCY AND VOLTAGE DEVIATIONS

ECC.6.3.12.1 As stated in ECC.6.1.2, the **System Frequency** could rise to 52Hz or fall to 47Hz. Each **Power Generating Module** (including **DC Connected Power Park Modules**) must continue to operate within this **Frequency** range for at least the periods of time given in ECC.6.1.2 unless **NGET** has specified any requirements for combined **Frequency** and voltage deviations which are required to ensure the best use of technical capabilities of **Power Generating Modules** (including **DC Connected Power Park Modules**) if required to preserve or restore system security.- Notwithstanding this requirement, **EU Generators** should also be aware of the requirements of ECC.6.3.13.

ECC.6.3.13 FREQUENCY, RATE OF CHANGE OF FREQUENCY AND VOLTAGE PROTECTION SETTING ARRANGEMENTS

ECC.6.3.13.1 **EU Generators** (including in respect of **OTSDUW Plant and Apparatus**) and **HVDC System Owners** will be responsible for protecting all their **Power Generating Modules** (and **OTSDUW Plant and Apparatus**) or **HVDC Equipment** against damage should **Frequency** excursions outside the range 52Hz to 47Hz ever occur. Should such excursions occur, it is up to the **EU Generator** or **HVDC System Owner** to decide whether to disconnect his **Apparatus** for reasons of safety of **Apparatus, Plant** and/or personnel.

ECC.6.3.13.2 Each **Power Generating Module** when connected and synchronised to the **System**, shall be capable of withstanding without tripping a rate of change of **Frequency** up to and including 1 Hz per second as measured over a rolling 500 milliseconds period. Voltage dips may cause localised rate of change of **Frequency** values in excess of 1 Hz per second for short periods, and in these cases, the requirements under ECC.6.3.15 (fault ride through) supersedes this clause. For the avoidance of doubt, this requirement relates to the capabilities of **Power Generating Modules** only and does not impose the need for rate of change of **Frequency** protection nor does it impose a specific setting for anti-islanding or loss-of-mains protection relays.

ECC.6.3.13.3 Each **HVDC System** and **Remote End HVDC Converter Station** when connected and synchronised to the **System**, shall be capable of withstanding without tripping a rate of change of **Frequency** up to and including ± 2.5 Hz per second as measured over the previous 1 second period. Voltage dips may cause localised rate of change of **Frequency** values in excess of ± 2.5 Hz per second for short periods, and in these cases, the requirements under ECC.6.3.15 (fault ride through) supersedes this clause. For the avoidance of doubt, this requirement relates to the capabilities of **HVDC Systems** and **Remote End HVDC Converter Stations** only and does not impose the need for rate of change of **Frequency** protection nor does it impose a specific setting for anti-islanding or loss-of-mains protection relays.

ECC.6.3.13.4 Each **DC Connected Power Park Module** when connected to the **System**, shall be capable of withstanding without tripping a rate of change of **Frequency** up to and including ± 2.0 Hz per second as measured over the previous 1 second period. Voltage dips may cause localised rate of change of **Frequency** values in excess of ± 2.0 Hz per second for short periods, and in these cases, the requirements under ECC.6.3.15 (fault ride through) supersedes this clause. For the avoidance of doubt, this requirement relates to the capabilities of **DC Connected Power Park Modules** only and does not impose the need for rate of change of **Frequency** protection nor does it impose a specific setting for anti-islanding or loss-of-mains protection relays.

ECC.6.3.13.5 As stated in ECC.6.1.2, the **System Frequency** could rise to 52Hz or fall to 47Hz and the **System** voltage at the **Grid Entry Point** or **User System Entry Point** could rise or fall within the values outlined in ECC.6.1.4. Each **Type C** and **Type D Power Generating Module** (including **DC Connected Power Park Modules**) or any constituent element must continue to operate within this **Frequency** range for at least the periods of time given in ECC.6.1.2 and voltage range as defined in ECC.6.1.4 unless **NGET** has agreed to any simultaneous overvoltage and underfrequency relays and/or simultaneous undervoltage and over frequency relays which will trip such **Power Generating Module** (including **DC Connected Power Park Modules**), and any constituent element within this **Frequency** or voltage range.

ECC.6.3.14 **FAST START CAPABILITY**

ECC.6.3.14.1 It may be agreed in the **Bilateral Agreement** that a **Genset** shall have a **Fast-Start**

Capability. Such **Gensets** may be used for **Operating Reserve** and their **Start-Up** may be initiated by **Frequency-level** relays with settings in the range 49Hz to 50Hz as specified pursuant to **OC2**.

ECC.6.3.15 FAULT RIDE THROUGH

ECC.6.3.15.1 General **Fault Ride Through** requirements, principles and concepts applicable to **Type B, Type C** and **Type D Power Generating Modules** and **OTSDUW Plant and Apparatus** subject to faults up to 140ms in duration

ECC.6.3.15.1.1 ECC.6.3.15.1 – ECC.6.3.15.8 section sets out the **Fault Ride Through** requirements on **Type B, Type C** and **Type D Power Generating Modules, OTSDUW Plant and Apparatus** and **HVDC Equipment** that shall apply in the event of a fault lasting up to 140ms in duration.

ECC.6.3.15.1.2 Each **Power Generating Module, Power Park Module, HVDC Equipment** and **OTSDUW Plant and Apparatus** is required to remain connected and stable for any balanced and unbalanced fault where the voltage at the **Grid Entry Point** or **User System Entry Point** or **HVDC Interface Point** in the case of **Remote End DC Converter Stations** or **Interface Point** in the case of **OTSDUW Plant and Apparatus** remains on or above the heavy black line defined in sections ECC.6.3.15.2 – ECC.6.3.15.7 below.

ECC.6.3.15.1.3 The voltage against time curves defined in ECC.6.3.15.2 – ECC.6.3.15.7 expresses the lower limit (expressed as the ratio of its actual value and its reference 1pu) of the actual course of the phase to phase voltage (or phase to earth voltage in the case of asymmetrical/unbalanced faults) on the **System** voltage level at the **Grid Entry Point** or **User System Entry Point** (or **HVDC Interface Point** in the case of **Remote End HVDC Converter Stations** or **Interface Point** in the case of **OTSDUW Plant and Apparatus**) during a symmetrical or asymmetrical/unbalanced fault, as a function of time before, during and after the fault.

ECC.6.3.15.2 Voltage against time curve and parameters applicable to **Type B Synchronous Power Generating Modules**

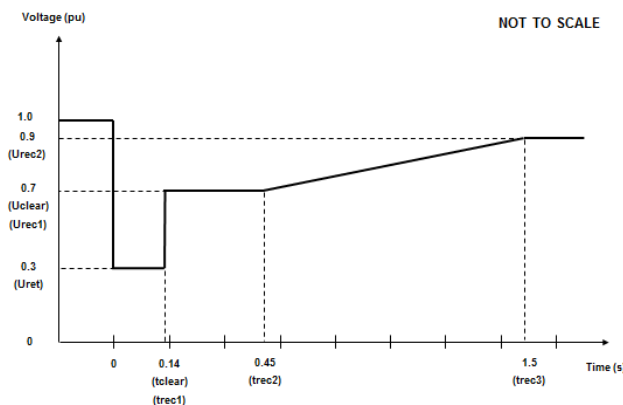

Figure ECC.6.3.15.2 - Voltage against time curve applicable to **Type B Synchronous Power Generating Modules**

Voltage parameters (pu)		Time parameters (seconds)	
Uret	0.3	tclear	0.14
Uclear	0.7	trec1	0.14
Urec1	0.7	trec2	0.45
Urec2	0.9	trec3	1.5

Table ECC.6.3.15.2 Voltage against time parameters applicable to **Type B Synchronous Power Generating Modules**

ECC.6.3.15.3 Voltage against time curve and parameters applicable to Type C and D Synchronous Power Generating Modules connected below 110kV

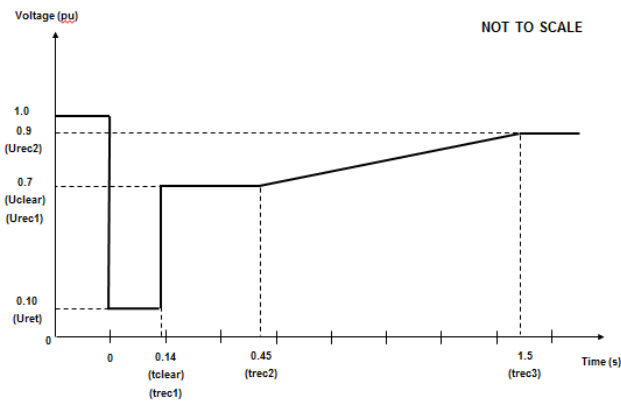

Figure ECC.6.3.15.3 - Voltage against time curve applicable to **Type C and D Synchronous Power Generating Modules** connected below 110kV

Voltage parameters (pu)		Time parameters (seconds)	
Uret	0.1	tclear	0.14
Uclear	0.7	trec1	0.14
Urec1	0.7	trec2	0.45
Urec2	0.9	trec3	1.5

Table ECC.6.3.15.3 Voltage against time parameters applicable to **Type C and D Synchronous Power Generating Modules** connected below 110kV

ECC.6.3.15.4 Voltage against time curve and parameters applicable to Type D Synchronous Power Generating Modules connected at or above 110kV

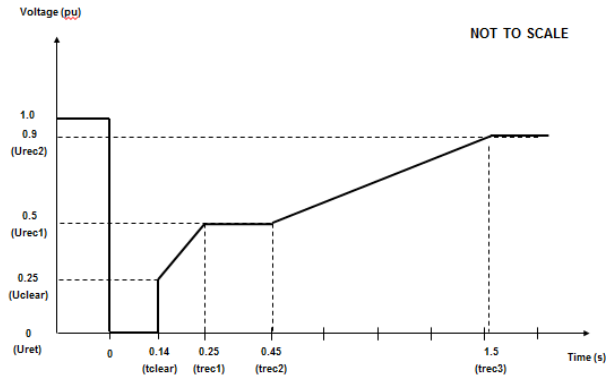

Figure ECC.6.3.15.4 - Voltage against time curve applicable to **Type D Synchronous Power Generating Modules** connected at or above 110kV

Voltage parameters (pu)		Time parameters (seconds)	
Uret	0	tclear	0.14
Uclear	0.25	trec1	0.25
Urec1	0.5	trec2	0.45
Urec2	0.9	trec3	1.5

Table ECC.6.3.15.4 Voltage against time parameters applicable to **Type D Synchronous Power Generating Modules** connected at or above 110kV

ECC.6.3.15.5 Voltage against time curve and parameters applicable to Type B, C and D Power Park Modules connected below 110kV

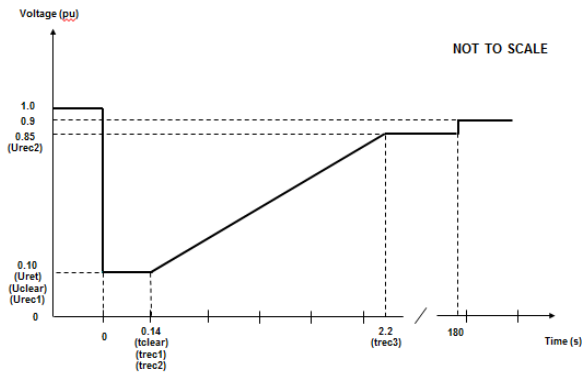

Figure ECC.6.3.15.5 - Voltage against time curve applicable to **Type B, C and D Power Park Modules** connected below 110kV

Voltage parameters (pu)		Time parameters (seconds)	
Uret	0.10	tclear	0.14
Uclear	0.10	trec1	0.14
Urec1	0.10	trec2	0.14

Urec2	0.85	trec3	2.2
-------	------	-------	-----

Table ECC.6.3.15.5 Voltage against time parameters applicable to **Type B, C and D Power Park Modules** connected below 110kV

ECC.6.3.15.6 Voltage against time curve and parameters applicable to Type D Power Park Modules with a Grid Entry Point or User System Entry Point at or above 110kV, DC Connected Power Park Modules at the HVDC Interface Point or OTSDUW Plant and Apparatus at the Interface Point.

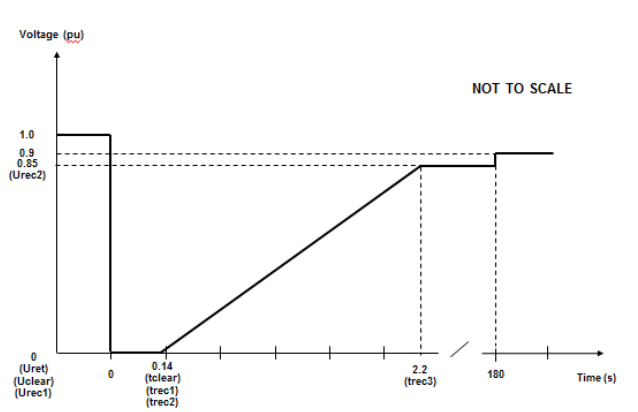

Figure ECC.6.3.15.6 - Voltage against time curve applicable to **Type D Power Park Modules** with a **Grid Entry Point** or **User System Entry Point** at or above 110kV, **DC Connected Power Park Modules** at the **HVDC Interface Point** or **OTSDUW Plant and Apparatus** at the **Interface Point**.

Voltage parameters (pu)		Time parameters (seconds)	
Uret	0	tclear	0.14
Uclear	0	trec1	0.14
Urec1	0	trec2	0.14
Urec2	0.85	trec3	2.2

Table ECC.6.3.15.6 Voltage against time parameters applicable to a **Type D Power Park Modules** with a **Grid Entry Point** or **User System Entry Point** at or above 110kV, **DC Connected Power Park Modules** at the **HVDC Interface Point** or **OTSDUW Plant and Apparatus** at the **Interface Point**.

ECC.6.3.15.7 Voltage against time curve and parameters applicable to HVDC Systems and Remote End HVDC Converter Stations

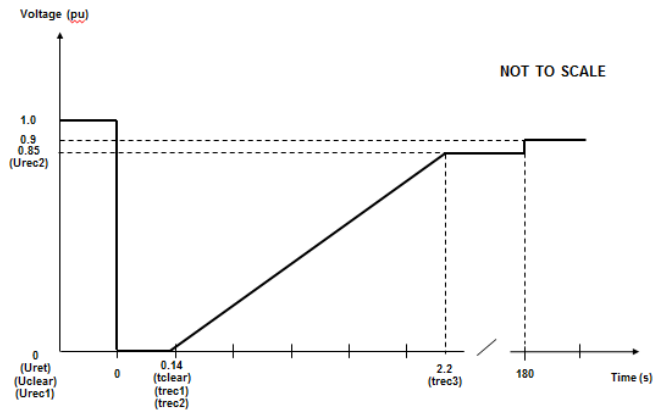

Figure ECC.6.3.15.7 - Voltage against time curve applicable to HVDC Systems and Remote End HVDC Converter Stations

Voltage parameters (pu)	Time parameters (seconds)
Uret	0
Uclear	0
Urec1	0
Urec2	0.85
tclear	0.14
trec1	0.14
trec2	0.14
trec3	2.2

Table ECC.6.3.15.7 Voltage against time parameters applicable to HVDC Systems and Remote End HVDC Converter Stations

- ECC.6.3.15.8 In addition to the requirements in ECC.6.3.15.1 – ECC.6.3.15.7:
- (i) Each **Type B, Type C and Type D Power Generating Module** at the **Grid Entry Point** or **User System Entry Point**, **HVDC Equipment** (or **OTSDUW Plant and Apparatus** at the **Interface Point**) shall be capable of satisfying the above requirements when operating at **Rated MW** output and maximum leading **Power Factor**.
 - (ii) **NGET** will specify upon request by the **User** the pre-fault and post fault short circuit capacity (in MVA) at the **Grid Entry Point** or **User System Entry Point** (or **HVDC Interface Point** in the case of a remote end **HVDC Converter Stations** or **Interface Point** in the case of **OTSDUW Plant and Apparatus**).
 - (iii) The pre-fault voltage shall be taken to be 1.0pu and the post fault voltage shall not be less than 0.9pu.
 - (iv) To allow a **User** to model the **Fault Ride Through** performance of its **Type B, Type C** and/or **Type D Power Generating Modules** or **HVDC Equipment**, **NGET** will provide additional network data as may reasonably be required by the **EU Code User** to undertake such study work in accordance with **PC.A.8**. Alternatively, **NGET** may provide generic values derived from typical cases.
 - (v) **NGET** will publish fault level data under maximum and minimum demand conditions in the **Electricity Ten Year Statement**.

Formatted: Font: Not Bold

(vi) Each **EU Generator** (in respect of **Type B, Type C, Type D Power Generating Modules** and **DC Connected Power Park Modules**) and **HVDC System Owners** (in respect of **HVDC Systems**) shall satisfy the requirements in ECC.6.3.15.8(i) – (vii) unless the protection schemes and settings for internal electrical faults trips the **Type B, Type C and Type D Power Generating Module, HVDC Equipment** (or **OTSDUW Plant and Apparatus**) from the **System**. The protection schemes and settings should not jeopardise **Fault Ride Through** performance as specified in ECC.6.3.15.8(i) – (vii). The undervoltage protection at the **Grid Entry Point** or **User System Entry Point** (or **HVDC Interface Point** in the case of a **Remote End HVDC Converter Stations** or **Interface Point** in the case of **OTSDUW Plant and Apparatus**) shall be set by the **EU Generator** (or **HVDC System Owner** or **OTSDUA** in the case of **OTSDUW Plant and Apparatus**) according to the widest possible range unless **NGET** and the **EU Code User** have agreed to narrower settings. All protection settings associated with undervoltage protection shall be agreed between the **EU Generator** and/or **HVDC System Owner** with **NGET** and **Relevant Transmission Licensee’s** and relevant **Network Operator** (as applicable).

(vii) Each **Type B, Type C and Type D Power Generating Module, HVDC System** and **OTSDUW Plant and Apparatus** at the **Interface Point** shall be designed such that upon clearance of the fault on the **Onshore Transmission System** and within 0.5 seconds of restoration of the voltage at the **Grid Entry Point** or **User System Entry Point** or **HVDC Interface Point** in the case of a **Remote End HVDC Converter Stations** or **Interface Point** in the case of **OTSDUW Plant and Apparatus** to 90% of nominal voltage or greater, **Active Power** output (or **Active Power** transfer capability in the case of **OTSDW Plant and Apparatus** or **Remote End HVDC Converter Stations**) shall be restored to at least 90% of the level immediately before the fault. Once **Active Power** output (or **Active Power** transfer capability in the case of **OTSDUW Plant and Apparatus** or **Remote End HVDC Converter Stations**) has been restored to the required level, **Active Power** oscillations shall be acceptable provided that:

- The total **Active Energy** delivered during the period of the oscillations is at least that which would have been delivered if the **Active Power** was constant
- The oscillations are adequately damped.
- In the event of power oscillations, **Power Generating Modules** shall retain steady state stability when operating at any point on the **Power Generating Module Performance Chart**.

For AC Connected **Onshore and Offshore Power Park Modules** comprising switched reactive compensation equipment (such as mechanically switched capacitors and reactors), such switched reactive compensation equipment shall be controlled such that it is not switched in or out of service during the fault but may act to assist in post fault voltage recovery.

ECC.6.3.15.9 General Fault Ride Through requirements for faults in excess of 140ms in duration.

ECC.6.3.15.9.1 General Fault Ride Through requirements applicable to HVDC Equipment and OTSDUW DC Converters subject to faults and voltage dips in excess of 140ms.

ECC.6.3.15.9.1.1 The requirements applicable to **HVDC Equipment** including **OTSDUW DC Converters** subject to faults and voltage disturbances at the **Grid Entry Point** or **User System Entry Point** or **Interface Point** or **HVDC Interface Point**, including **Active Power** transfer capability shall be specified in the **Bilateral Agreement**.

ECC.6.3.15.9.2 Fault Ride Through requirements for Type C and Type D Synchronous Power Generating Modules and Type C and Type D Power Park Modules and OTSDUW Plant and Apparatus subject to faults and voltage disturbances on the Onshore Transmission System in excess of 140ms

ECC.6.3.15.9.2.1 The **Fault Ride Through** requirements for **Type C** and **Type D Synchronous Power Generating Modules** subject to faults and voltage disturbances on the Onshore Transmission System in excess of 140ms are defined in ECC.6.3.15.9.2.1(a) and the **Fault Ride Through Requirements for Power Park Modules and OTSDUW Plant and Apparatus** subject to faults and voltage disturbances on the Onshore Transmission System greater than 140ms in duration are defined in ECC.6.3.15.9.2.1(b).

(a) Requirements applicable to **Synchronous Power Generating Modules** subject to **Supergrid Voltage** dips on the **Onshore Transmission System** greater than 140ms in duration.

In addition to the requirements of ECC.6.3.15.1 – ECC.6.3.15.8 each **Synchronous Power Generating Module** shall:

(i) remain transiently stable and connected to the **System** without tripping of any **Synchronous Power Generating Module** for balanced **Supergrid Voltage** dips and associated durations on the **Onshore Transmission System** (which could be at the **Interface Point**) anywhere on or above the heavy black line shown in Figure ECC.6.3.15.9(a) Appendix 4 and Figures EA.4.3.2(a), (b) and (c) provide an explanation and illustrations of Figure ECC.6.3.15.9(a); and,

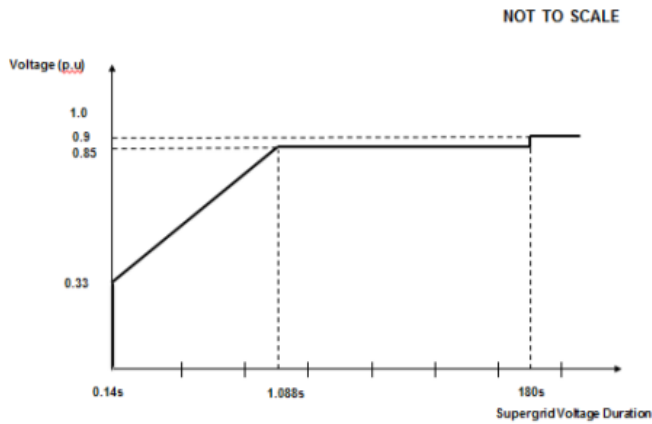

Figure ECC.6.3.15.9(a)

(ii) provide **Active Power** output at the **Grid Entry Point**, during **Supergrid Voltage** dips on the **Onshore Transmission System** as described in Figure ECC.6.3.15.9(a), at least in proportion to the retained balanced voltage at the **Onshore Grid Entry Point** (for **Onshore Synchronous Power Generating Modules**) or **Interface Point** (for **Offshore Synchronous Power Generating Modules**) (or the retained balanced voltage at the **User System Entry Point** if **Embedded**) and shall generate maximum reactive current (where the voltage at the **Grid Entry Point** is outside the limits specified in ECC.6.1.4) without exceeding the transient rating limits of the **Synchronous Power Generating Module** and,

(iii) restore **Active Power** output following **Supergrid Voltage** dips on the **Onshore Transmission System** as described in Figure ECC.6.3.15.9(a), within 1 second of restoration of the voltage to 1.0pu of the nominal voltage at the:

Onshore Grid Entry Point for directly connected **Onshore Synchronous Power Generating Modules** or,

Interface Point for **Offshore Synchronous Power Generating Modules** or,

User System Entry Point for **Embedded Onshore Synchronous Power Generating Modules**

or,

User System Entry Point for **Embedded Medium Power Stations** not subject to a **Bilateral Agreement** which comprise **Synchronous Generating Units** and with an **Onshore User System Entry Point** (irrespective of whether they are located **Onshore** or **Offshore**)

to at least 90% of the level available immediately before the occurrence of the dip. Once the **Active Power** output has been restored to the required level, **Active Power** oscillations shall be acceptable provided that:

- the total **Active Energy** delivered during the period of the oscillations is at least that which would have been delivered if the **Active Power** was constant
- the oscillations are adequately damped.

For the avoidance of doubt a balanced **Onshore Transmission System Supergrid Voltage** meets the requirements of ECC.6.1.5 (b) and ECC.6.1.6.

(b) Requirements applicable to **Type C** and **Type D Power Park Modules** and **OTSDUW Plant and Apparatus** (excluding **OTSDUW DC Converters**) subject to **Supergrid Voltage** dips on the **Onshore Transmission System** greater than 140ms in duration.

In addition to the requirements of ECC.6.3.15.5, ECC.6.3.15.6 and ECC.6.3.15.8 (as applicable) each **OTSDUW Plant and Apparatus** or each **Power Park Module** and / or any constituent **Power Park Unit**, shall:

(i) remain transiently stable and connected to the **System** without tripping of any **OTSDUW Plant and Apparatus**, or **Power Park Module** and / or any constituent **Power Park Unit**, for balanced **Supergrid Voltage** dips and associated durations on the **Onshore Transmission System** (which could be at the **Interface Point**) anywhere on or above the heavy black line shown in Figure ECC.6.3.15.9(b). Appendix 4 and Figures EA.4.3.4 (a), (b) and (c) provide an explanation and illustrations of Figure ECC.6.3.15.9(b); and,

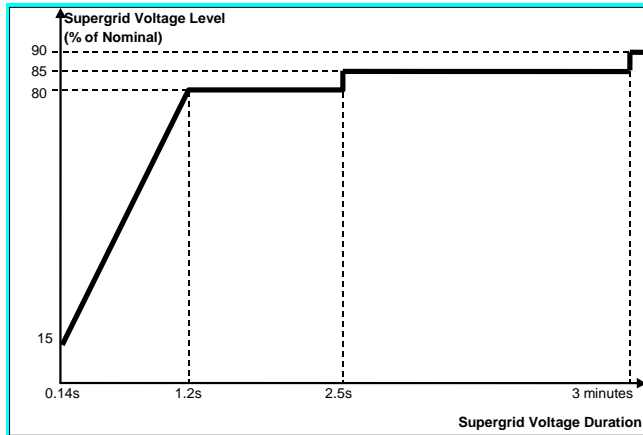

Figure ECC.6.3.15.9(b)

(ii) provide Active Power output at the Grid Entry Point or in the case of an OTSDUW, Active Power transfer capability at the Transmission Interface Point, during Supergrid Voltage dips on the Onshore Transmission System as described in Figure ECC.6.3.15.9(b), at least in proportion to the retained balanced voltage at the Onshore Grid Entry Point (for Onshore Power Park Modules) or Interface Point (for OTSDUW Plant and Apparatus and Offshore Power Park Modules) (or the retained balanced voltage at the User System Entry Point if Embedded) except in the case of a Non-Synchronous Generating Unit or OTSDUW Plant and Apparatus or Power Park Module where there has been a reduction in the Intermittent Power Source or in the case of OTSDUW Active Power transfer capability in the time range in Figure ECC.6.3.15.9(b) that restricts the Active Power output or in the case of an OTSDUW Active Power transfer capability below this level.

(iii) restore Active Power output (or, in the case of OTSDUW, Active Power transfer capability), following Supergrid Voltage dips on the Onshore Transmission System as described in Figure ECC.6.3.15.9(b), within 1 second of restoration of the voltage at the:

Onshore Grid Entry Point for directly connected Onshore Power Park Modules or,

Interface Point for OTSDUW Plant and Apparatus and Offshore Power Park Modules or,

User System Entry Point for Embedded Onshore Power Park Modules or,

User System Entry Point for Embedded Medium Power Stations which comprise Power Park Modules not subject to a Bilateral Agreement and with an Onshore User System Entry Point (irrespective of whether they are located Onshore or Offshore)

to the minimum levels specified in ECC.6.1.4 to at least 90% of the level available immediately before the occurrence of the dip except in the case of a Non-Synchronous Generating Unit, OTSDUW Plant and Apparatus or Power Park Module where there has been a reduction in the Intermittent Power Source in

the time range in Figure ECC.6.3.15.9(b) that restricts the **Active Power** output or, in the case of **OTSDUW, Active Power** transfer capability below this level. Once the **Active Power** output or, in the case of **OTSDUW, Active Power** transfer capability has been restored to the required level, **Active Power** oscillations shall be acceptable provided that:

- the total **Active Energy** delivered during the period of the oscillations is at least that which would have been delivered if the **Active Power** was constant
- the oscillations are adequately damped.

For the avoidance of doubt a balanced **Onshore Transmission System Supergrid Voltage** meets the requirements of ECC.6.1.5 (b) and ECC.6.1.6.

ECC.6.3.15.10 Other Fault Ride Through Requirements

- (i) In the case of a **Power Park Module**, the requirements in ECC.6.3.15.9 do not apply when the **Power Park Module** is operating at less than 5% of its **Rated MW** or during very high primary energy source conditions when more than 50% of the **Power Park Units** in a **Power Park Module** have been shut down or disconnected under an emergency shutdown sequence to protect **User's Plant and Apparatus**.
- (ii) In addition to meeting the conditions specified in ECC.6.1.5(b) and ECC.6.1.6, each **Non-Synchronous Generating Unit, OTSDUW Plant and Apparatus** or **Power Park Module** and any constituent **Power Park Unit** thereof will be required to withstand, without tripping, the negative phase sequence loading incurred by clearance of a close-up phase-to-phase fault, by **System Back-Up Protection** on the **Onshore Transmission System** operating at **Supergrid Voltage**.
- (iii) **Generators** in respect of **Type B, Type C and Type D Power Park Modules** and **HVDC System Owners** are required to confirm to **NGET**, their repeated ability to operate through balanced and unbalanced faults and **System** disturbances each time the voltage at the **Grid Entry Point** or **User System Entry Point** falls outside the limits specified in ECC.6.1.4. Demonstration of this capability would be satisfied by **EU Generators** and **HVDC System Owners** supplying the protection settings of their plant, informing **NGET** of the maximum number of repeated operations that can be performed under such conditions and any limiting factors to repeated operation such as protection or thermal rating; and
- (iv) Notwithstanding the requirements of ECC.6.3.15(v), **Power Generating Modules** shall be capable of remaining connected during single phase or three phase auto-reclosures to the **National Electricity Transmission System** and operating without power reduction as long as the voltage and frequency remain within the limits defined in ECC.6.1.4 and ECC.6.1.2; and
- (v) For the avoidance of doubt the requirements specified in ECC.6.3.15 do not apply to **Power Generating Modules** connected to either an unhealthy circuit and/or islanded from the **Transmission System** even for delayed auto reclosure times.
- (vi) To avoid unwanted island operation, **Non-Synchronous Generating Units** in Scotland (and those directly connected to a **Scottish Offshore Transmission System**), **Power Park Modules** in Scotland (and those directly connected to a **Scottish Offshore Transmission System**), or **OTSDUW Plant and Apparatus** with an **Interface Point** in Scotland shall be tripped for the following conditions:
 - (1) **Frequency** above 52Hz for more than 2 seconds
 - (2) **Frequency** below 47Hz for more than 2 seconds
 - (3) **Voltage** as measured at the **Onshore Connection Point** or **Onshore User System Entry Point** or **Offshore Grid Entry Point** or **Interface Point** in the

case of **OTSDUW Plant and Apparatus** is below 80% for more than 2.5 seconds

Voltage as measured at the **Onshore Connection Point** or **Onshore User System Entry Point** or **Offshore Grid Entry Point** or **Interface Point** in the case of **OTSDUW Plant and Apparatus** is above 120% (115% for 275kV) for more than 1 second. The times in sections (1) and (2) are maximum trip times. Shorter times may be used to protect the **Non-Synchronous Generating Units**, or **OTSDUW Plant and Apparatus**.

ECC.6.3.15.11 **HVDC System Robustness**

ECC.6.3.15.11.1 The **HVDC System** shall be capable of finding stable operation points with a minimum change in **Active Power** flow and voltage level, during and after any planned or unplanned change in the **HVDC System** or **AC System** to which it is connected. **NGET** shall specify the changes in the System conditions for which the **HVDC Systems** shall remain in stable operation.

ECC.6.3.15.11.2 The **HVDC System** owner shall ensure that the tripping or disconnection of an **HVDC Converter Station**, as part of any multi-terminal or embedded **HVDC System**, does not result in transients at the **Grid Entry Point** or **User System Entry Point** beyond the limit specified by **NGET** in co-ordination with the **Relevant Transmission Licensee**.

ECC.6.3.15.11.3 The **HVDC System** shall withstand transient faults on HVAC lines in the network adjacent or close to the **HVDC System**, and shall not cause any of the equipment in the **HVDC System** to disconnect from the network due to autoreclosure of lines in the **System**.

ECC.6.3.15.11.4 The **HVDC System Owner** shall provide information to **NGET** on the resilience of the **HVDC System** to **AC System** disturbances.

ECC.6.3.16 **FAST FAULT CURRENT INJECTION**

ECC.6.3.16.1 General Fast Fault Current injection, principles and concepts applicable to Type B, Type C and Type D Power Park Modules and HVDC Equipment

ECC.6.3.16.1.1 Each **Type B**, **Type C** and **Type D Power Park Module** or **HVDC Equipment** shall be required to satisfy the following requirements.

ECC.6.3.16.1.2 For any balanced or unbalanced fault which results in the phase voltage on one or more phases falling outside the limits specified in ECC.6.1.2 at the **Grid Entry Point** or **User System Entry Point**, each **Type B, Type C and Type D Power Park Module** or **HVDC Equipment** shall, unless otherwise agreed with **NGET**, be required to inject a reactive current above the shaded area shown in Figure ECC.16.3.16(a) and Figure 16.3.16(b). For the purposes of this requirement, the maximum rated current is taken to be the maximum current each Power Park Module (or constituent **Power Park Unit**) or **HVDC Converter** is capable of supplying when operating at rated **Active Power** and rated **Reactive Power** (as required under ECC.6.3.2) at a nominal voltage of 1.0pu. For example, in the case of a 100MW **Power Park Module** the **Rated Active Power** would be taken as 100MW and the rated **Reactive Power** would be taken as 32.8MVAr (ie **Rated MW** output operating at 0.95 **Power Factor** lead or 0.95 **Power Factor** lag as required under ECC.6.3.2.4). For the avoidance of doubt, where the phase voltage at the **Grid Entry Point** or **User System Entry Point** is not zero, the reactive current injected shall be in proportion to the retained voltage at the **Grid Entry Point** or **User System Entry Point** but shall still be required to remain above the shaded area in Figure 16.3.16(a) and Figure 16.3.16(b).-

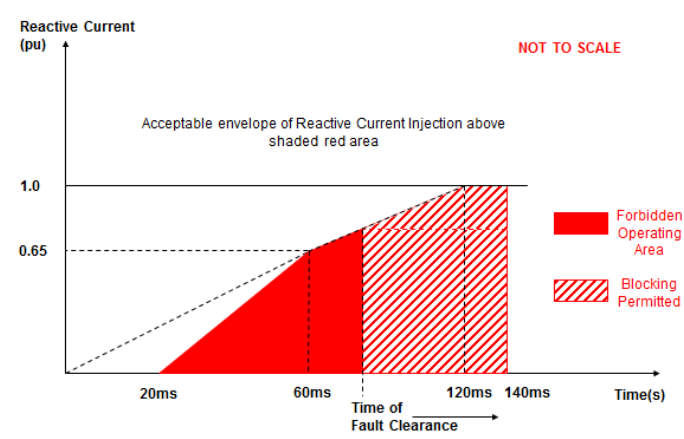

Figure ECC.16.3.16(a)

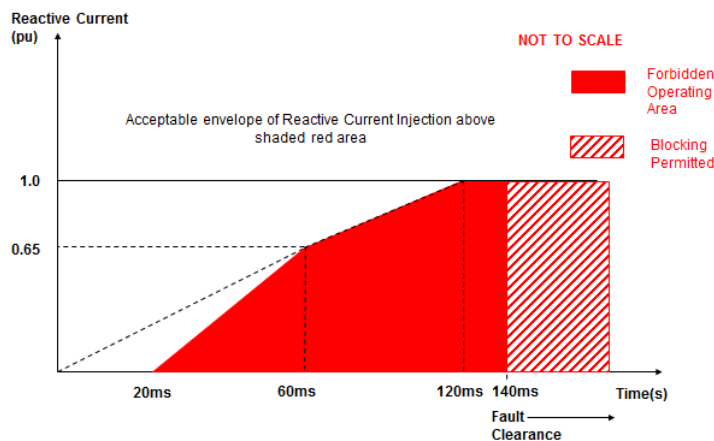

Figure ECC.16.3.16(b)

- ECC.6.3.16.1.3 The converter(s) of each **Type B, Type C and Type D Power Park Module or HVDC Equipment** is permitted to block upon fault clearance in order to mitigate against the risk of instability that would otherwise occur due to transient overvoltage excursions. Figure ECC.16.3.16(a) and Figure ECC.16.3.16(b) shows the impact of variations in fault clearance time which shall be no greater than 140ms. The requirements for the maximum transient overvoltage withstand capability and associated time duration, shall be agreed between the **EU Code User** and **NGET** as part of the **Bilateral Agreement**. Where the **EU Code User** is able to demonstrate to **NGET** that blocking is required in order to prevent the risk of transient over voltage excursions as specified in ECC.6.3.16.1.5. **EU Generators** and **HVDC System Owners** are required to both advise and agree with **NGET** of the control strategy, which must also include the approach taken to de-blocking. Notwithstanding this requirement, **EU Generators** and **HVDC System Owners** should be aware of their requirement to fully satisfy the fault ride through requirements specified in ECC.6.3.15.
- ECC.6.3.16.1.4 In addition, the reactive current injected from each **Power Park Module or HVDC Equipment** shall be injected in proportion and remain in phase to the change in **System** voltage at the **Connection Point** or **User System Entry Point** during the period of the fault. For the avoidance of doubt, a small delay time of no greater than 20ms from the point of fault inception is permitted before injection of the in phase reactive current.
- ECC.6.3.16.1.5 Each **Type B, Type C and Type D Power Park Module or HVDC Equipment** shall be designed to reduce the risk of transient over voltage levels arising following clearance of the fault. **EU Generators** or **HVDC System Owners** shall be permitted to block where the anticipated transient overvoltage would otherwise exceed the maximum permitted values specified in ECC.6.1.7. Any additional requirements relating to transient overvoltage performance will be specified by **NGET**.
- ECC.6.3.16.1.6 In addition to the requirements of ECC.6.3.15, **Generators** in respect of **Type B, Type C and Type D Power Park Modules** and **HVDC System Owners** are required to confirm to **NGET**, their repeated ability to supply **Fast Fault Current** to the **System** each time the voltage at the **Grid Entry Point** or **User System Entry Point** falls outside the limits specified in ECC.6.1.4. **EU Generators** and **HVDC Equipment Owners** should inform **NGET** of the maximum number of repeated operations that can be performed under such conditions and any limiting factors to repeated operation such as protection or thermal rating; and
- ECC.6.3.16.1.7 In the case of a **Power Park Module** or **DC Connected Power Park Module**, where it is not practical to demonstrate the compliance requirements of ECC.6.3.16.1.1 to ECC.6.3.16.1.6 at the **Grid Entry Point** or **User System Entry Point**, **NGET** will accept compliance of the above requirements at the **Power Park Unit** terminals.
- ECC.6.3.16.1.8 An illustration and examples of the performance requirements expected are illustrated in Appendix 4EC.
- ECC.6.3.17 **SUBSYNCHRONOUS TORSIONAL INTERACTION DAMPING CAPABILITY, POWER OSCILLATION DAMPING CAPABILITY AND CONTROL FACILITIES FOR HVDC SYSTEMS**
- ECC.6.3.17.1 **Subsynchronous Torsional Interaction Damping Capability**

ECC.6.3.17.1.1 HVDC System Owners, or Generators in respect of OTSDUW DC Converters or Network Operators in the case of an **Embedded HVDC Systems** not subject to a **Bilateral Agreement** must ensure that any of their **Onshore HVDC Systems** or **OTSDUW DC Converters** will not cause a sub-synchronous resonance problem on the **Total System**. Each **HVDC System** or **OTSDUW DC Converter** is required to be provided with sub-synchronous resonance damping control facilities. **HVDC System Owners** and **EU Generators** in respect of **OTSDUW DC Converters** should also be aware of the requirements in ECC.6.1.9 and ECC.6.1.10.

ECC.6.3.17.1.2 Where specified in the **Bilateral Agreement**, each **OTSDUW DC Converter** is required to be provided with power oscillation damping or any other identified additional control facilities.

ECC.6.3.17.1.3 Each **HVDC System** shall be capable of contributing to the damping of power oscillations on the **National Electricity Transmission System**. The control system of the **HVDC System** shall not reduce the damping of power oscillations. **NGET** in coordination with the **Relevant Transmission Licensee** (as applicable) shall specify a frequency range of oscillations that the control scheme shall positively damp and the **System** conditions when this occurs, at least accounting for any dynamic stability assessment studies undertaken by the **Relevant Transmission Licensee** or **NGET** (as applicable) to identify the stability limits and potential stability problems on the **National Electricity Transmission System**. The selection of the control parameter settings shall be agreed between **NGET** in coordination with the **Relevant Transmission Licensee** and the **HVDC System Owner**.

ECC.6.3.17.1.4 **NGET** shall specify the necessary extent of SSTI studies and provide input parameters, to the extent available, related to the equipment and relevant system conditions on the **National Electricity Transmission System**. The SSTI studies shall be provided by the **HVDC System Owner**. The studies shall identify the conditions, if any, where SSTI exists and propose any necessary mitigation procedure. The responsibility for undertaking the studies in accordance with these requirements lies with the **Relevant Transmission Licensee** in coordination with **NGET**. All parties shall be informed of the results of the studies.

ECC.6.3.17.1.5 All parties identified by **NGET** as relevant to each **Grid Entry Point** or **User System Entry Point (if Embedded)**, including the **Relevant Transmission Licensee**, shall contribute to the studies and shall provide all relevant data and models as reasonably required to meet the purposes of the studies. **NGET** shall collect this data and, where applicable, pass it on to the party responsible for the studies in accordance with Article 10 of **European Regulation 2016/1447**. Specific information relating to the interface schedules, input/output requirements, timing and submission of any studies or data would be agreed between the **User** and **NGET** and specified (where applicable) in the **Bilateral Agreement**.

ECC.6.3.17.1.6 **NGET** in coordination with the **Relevant Transmission Licensee** shall assess the result of the SSTI studies. If necessary for the assessment, **NGET** in coordination with the **Relevant Transmission Licensee** may request that the **HVDC System Owner** perform further SSTI studies in line with this same scope and extent.

ECC.6.3.17.1.7 **NGET** in coordination with the **Relevant Transmission Licensee** may review or replicate the study. The **HVDC System Owner** shall provide **NGET** with all relevant data and models that allow such studies to be performed. Submission of this data to **Relevant Transmission Licensee's** shall be in accordance with the requirements of Article 10 of **European Regulation 2016/1447**.

ECC.6.3.17.1.8 Any necessary mitigating actions identified by the studies carried out in accordance with paragraphs ECC.6.3.17.1.4 or ECC.6.3.17.1.6, and reviewed by **NGET** in coordination with the **Relevant Transmission Licensees**, shall be undertaken by the **HVDC System Owner** as part of the connection of the new **HVDC Converter Station**.

ECC.6.3.17.1.9 As part of the studies and data flow in respect of ECC.6.3.17.1 – ECC.6.3.17.8 the following data exchange would take place with the time scales being pursuant to the terms of the **Bilateral Agreement**.

Information supplied by **NGET** and **Relevant Transmission Licensees**

Studies provided by the **User**

User review

NGET review

Changes to studies and agreed updates between **NGET**, the **Relevant Transmission Licensee** and **User**

Final review

ECC.6.3.17.2 Interaction between HVDC Systems or other User's Plant and Apparatus

ECC.6.3.17.2.1 Notwithstanding the requirements of ECC.6.1.9 and ECC.6.1.10, when several **HVDC Converter Stations** or other **User's Plant** and **Apparatus** are within close electrical proximity, **NGET** ~~the relevant TSO~~ may specify that a study is required, and the scope and extent of that study, to demonstrate that no adverse interaction will occur. If adverse interaction is identified, the studies shall identify possible mitigating actions to be implemented to ensure compliance with the requirements of ECC.6.1.9

ECC.6.3.17.2.2 The studies shall be carried out by the connecting **HVDC System Owner** with the participation of all other **User's** identified by **NGET** in coordination with **Relevant Transmission Licensees** ~~the TSOs~~ as relevant to each **Connection Point**.

ECC.6.3.17.2.3 All **User's** identified by **NGET** as relevant to the connection, and where applicable ~~the Relevant Transmission Licensee's TSO~~, shall contribute to the studies and shall provide all relevant data and models as reasonably required to meet the purposes of the studies. **NGET** shall collect this input and, where applicable, pass it on to the party responsible for the studies in accordance with Article 10 of **European Regulation 2016/1447**. Specific information relating to the interface schedules, input/output requirements, timing and submission of any studies or data would be agreed between the **User** and **NGET** and specified (where applicable) in the **Bilateral Agreement**.

ECC.6.3.17.2.4 **NGET** in coordination with **Relevant Transmission Licensees** shall assess the result of the studies based on their scope and extent as specified in accordance with ECC.6.3.17.2.1. If necessary for the assessment, **NGET** in coordination with the **Relevant Transmission Licensee** may request the **HVDC System Owner** to perform further studies in line with the scope and extent specified in accordance with ECC.6.3.17.2.1.

ECC.6.3.17.2.5 **NGET** in coordination with the **Relevant Transmission Licensee** may review or replicate some or all of the studies. The **HVDC System Owner** shall provide **NGET** all relevant data and models that allow such studies to be performed.

ECC.6.3.17.2.6 The **EU Code User** and **NGET**, in coordination with the **Relevant Transmission Licensee**, shall agree any mitigating actions identified by the studies carried out following the site specific requirements and works, including any transmission reinforcement works and / or **User** works required to ensure that all sub-synchronous oscillations are sufficiently damped.

ECC.6.1.17.3 **Fast Recovery from DC faults**

ECC.6.1.17.3.1 **HVDC Systems**, including DC overhead lines, shall be capable of fast recovery from transient faults within the **HVDC System**. Details of this capability shall be subject to the **Bilateral Agreement** and the protection requirements specified in ECC.6.2.2 .

ECC.6.1.17.4 **Maximum loss of Active Power**

ECC.6.1.14.4.1 An **HVDC System** shall be configured in such a way that its loss of **Active Power** injection in the **GB Synchronous Area** shall be in accordance with the requirements of the **SQSS**.

ECC.6.3.18 **SYSTEM TO GENERATOR OPERATIONAL INTERTRIPPING SCHEMES**

ECC.6.3.18.1 **NGET** may require that a **System to Generator Operational Intertripping Scheme** be installed as part of a condition of the connection of the **EU Generator**. Scheme specific details shall be included in the relevant **Bilateral Agreement** and shall, include the following information:

- (1) the relevant category(ies) of the scheme (referred to as **Category 1 Intertripping Scheme, Category 2 Intertripping Scheme, Category 3 Intertripping Scheme and Category 4 Intertripping Scheme**);
- (2) the **Power Generating Module** to be either permanently armed or that can be instructed to be armed in accordance with BC2.8;
- (3) the time within which the **Power Generating Module** circuit breaker(s) are to be automatically tripped;
- (4) the location to which the trip signal will be provided by **NGET**. Such location will be provided by **NGET** prior to the commissioning of the **Power Generating Module**.

Where applicable, the **Bilateral Agreement** shall include the conditions on the **National Electricity Transmission System** during which **NGET** may instruct the **System to Generator Operational Intertripping Scheme** to be armed and the conditions that would initiate a trip signal.

ECC.6.3.18.2 The time within which the **Power Generating Module(s)** circuit breaker(s) need to be automatically tripped is determined by the specific conditions local to the **EU Generator**. This 'time to trip' (defined as the time from provision of the trip signal by **NGET** to the specified location, to circuit breaker main contact opening) can typically range from 100ms to 10sec. A longer time to trip may allow the initiation of an automatic reduction in the **Power Generating Module(s)** output prior to the automatic tripping of the **Power Generating Module(s)** circuit breaker. Where applicable **NGET** may provide separate trip signals to allow for either a longer or shorter 'time to trip' to be initiated.

ECC.6.4 **General Network Operator And Non-Embedded Customer Requirements**

ECC.6.4.1 This part of the **Grid Code** describes the technical and design criteria and performance requirements for **Network Operators** and **Non-Embedded Customers**.

Formatted: Font color: Auto

Formatted: Font color: Auto

Neutral Earthing

ECC.6.4.2 At nominal **System** voltages of 132kV and above the higher voltage windings of three phase transformers and transformer banks connected to the **National Electricity Transmission System** must be star connected with the star point suitable for connection to earth. The earthing and lower voltage winding arrangement shall be such as to ensure that the **Earth Fault Factor** requirement of paragraph ECC.6.2.1.1 (b) will be met on the **National Electricity Transmission System** at nominal **System** voltages of 132kV and above.

Formatted: Font color: Auto

Frequency Sensitive Relays

ECC.6.4.3 As explained under **OC6**, each **Network Operator** and **Non Embedded Customer**, will make arrangements that will facilitate automatic low **Frequency Disconnection of Demand** (based on **Annual ACS Conditions**). ECC.A.5.5 of Appendix E5 includes specifications of the local percentage **Demand** that shall be disconnected at specific frequencies. The manner in which **Demand** subject to low **Frequency** disconnection will be split into discrete MV blocks is specified in OC6.6. Technical requirements relating to **Low Frequency Relays** are also listed in Appendix E5.

Formatted: Font color: Auto

Formatted: Font color: Auto

Operational Metering

ECC.6.4.4 Where **NGET** can reasonably demonstrate that an **Embedded Medium Power Station** or **Embedded HVDC System** has a significant effect on the **National Electricity Transmission System**, it may require the **Network Operator** within whose **System** the **Embedded Medium Power Station or Embedded HVDC System** is situated to ensure that the operational metering equipment described in ECC.6.5.6 is installed such that **NGET** can receive the data referred to in ECC.6.5.6. In the case of an **Embedded Medium Power Station** subject to, or proposed to be subject to a **Bilateral Agreement**, **NGET** shall notify such **Network Operator** of the details of such installation in writing within 3 months of being notified of the application to connect under **CUSC** and in the case of an **Embedded Medium Power Station** not subject to, or not proposed to be subject to a **Bilateral Agreement** in writing as a **Site Specific Requirement** in accordance with the timescales in CUSC 6.5.5. In either case the **Network Operator** shall ensure that the data referred to in ECC.6.5.6 is provided to **NGET**.

Formatted: Font color: Auto

Formatted: Font color: Auto

Formatted: Font color: Auto

Formatted: Font color: Auto

Formatted: Font: Bold

Formatted: Font: Bold

Formatted: Font: Not Bold

Formatted: Font: Bold

Formatted: Font: Bold

Formatted: Font: Bold

Formatted: Font: Bold

Formatted: Font: Bold

Formatted: Font: Bold

Formatted: Font: Bold

Formatted: Font: Bold

Formatted: Font: Bold

Formatted: Font: Bold

Formatted: Font: Bold

Formatted: Font: Bold

Formatted: Font: Bold

Formatted: Font: Bold

Formatted: Font: Bold

Formatted: Font: Bold

Formatted: Font: Bold

Formatted: Font: Not Bold

Formatted: Font: Bold

Formatted: Font: Not Bold

ECC.6.4.5 Reactive Power Requirements at each EU Grid Supply Point

~~ECC.6.4.5.1 At each **EU Grid Supply Point**, **Network Operators and Non-Embedded Customers's and EU Network Operators's** who are **only EU Code Users** shall ensure their **Systems** are be capable of maintaining the steady state operation at their **EU Grid Supply Points** within the **Reactive Power range** limits as specified in ECC.6.4.5.1(a) and ECC.6.4.5.1(b). Where **NGET** requires a **Reactive Power range** which is broader/narrower than the limits defined in ECC.6.4.5.1(a) and ECC.6.4.5.1(b), this will be agreed as a reasonable requirement through joint assessment between the relevant **EU Code User Network Operator or Non-Embedded Customer** and **NGET** specified in the **Bilateral Agreement** and justified in accordance with the requirements of ECC.6.4.5.1(c), (d), (e-) and (f). For the avoidance of doubt, the requirements of ECC.6.4.5 do not apply to **GB Network Operators who are also GB Code Users** and own or operate one or more **EU Grid Supply Points**, only apply to **Network Operators who are EU Code Users and Non-Embedded Customers who are EU Code Users** in respect of **EU Grid Supply Points** alone and not **Grid Supply Points**, as specified by **NGET**. The **Reactive Power range** specified in the **Bilateral Agreement** shall not exceed the envelope of operation defined below.~~

Formatted: Font color: Auto

Formatted: Font color: Auto

Formatted: Font color: Auto

Formatted: Font: Bold

Formatted: Font: Bold

Formatted: Font: Not Bold

Formatted: Font: Bold

Formatted: Font: Bold

Formatted: Font: Bold

Formatted: Font: Bold

Formatted: Font: Bold

Formatted: Font: Bold

Formatted: Font: Bold

Formatted: Font: Bold

Formatted: Font: Bold

Formatted: Font: Bold

Formatted: Font: Bold

Formatted: Font: Bold

Formatted: Font: Bold

Formatted: Font: Bold

Formatted: Font: Bold

Formatted: Font: Bold

Formatted: Font: Bold

Formatted: Font: Not Bold

Formatted: Font: Bold

Formatted: Font: Not Bold

~~ECC.6.4.5.2 Where agreed with the **Network Operator** who is an **EU Code User** and justified through appropriate **System** studies, **NGET** may reasonably require (in co-ordination with the **Relevant Transmission Licensee**) the may require that a the **EU Network Operator** not to export **Reactive Power** who is also an **EU Code User** s **Systems** shall have the capability at the **EU Grid Supply Point** to not export **Reactive Power** (at nominal reference 1 pu voltage) at an **Active Power** flow of less than 25 % of the **Maximum Import Capability**. Where applicable, **Member States** the **Authority** may require **NGET** in coordination with the **Relevant Transmission Licensee** to justify its request through a joint analysis with the relevant **Network Operator** and demonstrate that any such requirement is reasonable. If this requirement is not justified based on the joint analysis, **NGET** in coordination with the **Relevant Transmission Licensee** and the **Network Operator** shall agree on necessary requirements according to the outcomes of a joint analysis.~~

Formatted: Font: Bold

Formatted: Font: Bold

Formatted: Font: Bold

Formatted: Font: Bold

Formatted: Font: Bold

Formatted: Font: Bold

Formatted: Font: Not Bold

Formatted: Font: Not Bold

Formatted: Font: Not Bold

Formatted: Font: Not Bold

~~ECC.6.4.5.3 Notwithstanding the requirements of ECC.6.4.5.1(b) and subject to agreement between **NGET** and the relevant **Network Operator** Without prejudice to ECC.6.4.5.1(b), **NGET** may require the **Network Operator** who is also an **EU Code User** there may be a requirement to actively control the exchange of **Reactive Power** at the **EU Grid Supply Point** for the benefit of the **Total System**. **NGET** and the relevant **Network Operator** shall agree on a method to carry out this control, to ensure the justified level of security of supply for both parties. Any such solution requirement including joint study work and timelines would be agreed between **NGET** and the relevant **Network Operator** as reasonable, efficient and proportionate. pursuant to the terms of the **Bilateral Agreement**. The justification shall include a roadmap in which the steps and the timeline for fulfilling the requirement are specified.~~

Formatted: Font: Bold

Formatted: Font: Bold

Formatted: Font: Bold

Formatted: Font: Bold

Formatted: Font: Bold

Formatted: Font: Bold

Formatted: Font: Bold

Formatted: Font: Bold

~~ECC.6.4.5.4 In accordance with ECC.6.4.5.3, the relevant **EU Network Operator** may require **NGET** to consider its **Network Operator's System** for **Reactive Power** management. Any such requirement would need to be agreed between **NGET** and the relevant **Network Operator** pursuant to the terms of the **Bilateral Agreement** but would need to be and justified by **NGET**.~~

Formatted: Font: Bold

Formatted: Font: Not Bold

Formatted: Font: Not Bold

Formatted: Font: Bold

Formatted: Font: Not Bold

Formatted: Font: Bold

Formatted: Highlight

ECC.6.5 Communications Plant

ECC.6.5.1 In order to ensure control of the **National Electricity Transmission System**, telecommunications between **Users** and **NGET** must (including in respect of any **OTSDUV Plant and Apparatus** at the **OTSUA Transfer Time**), if required by **NGET**, be established in accordance with the requirements set down below.

ECC.6.5.2 Control Telephony and System Telephony

ECC.6.5.2.1 **Control Telephony** is the principle method by which a **User's Responsible Engineer/Operator** and **NGET Control Engineers** speak to one another for the purposes of control of the **Total System** in both normal and emergency operating conditions. **Control Telephony** provides secure point to point telephony for routine **Control Calls**, priority **Control Calls** and emergency **Control Calls**.

ECC.6.5.2.2 **System Telephony** is an alternate method by which a **User's Responsible Engineer/Operator** and **NGET Control Engineers** speak to one another for the purposes of control of the **Total System** in both normal operating conditions and where practicable, emergency operating conditions. **System Telephony** uses the Public Switched Telephony Network to provide telephony for **Control Calls**, inclusive of emergency **Control Calls**.

ECC.6.5.2.3 Calls made and received over **Control Telephony** and **System Telephony** may be recorded and subsequently replayed for commercial and operational reasons.

ECC.6.5.3 Supervisory Tones

ECC.6.5.3.1 Control Telephony supervisory tones indicate to the calling and receiving parties dial, engaged, ringing, secondary engaged (signifying that priority may be exercised) and priority disconnect tones.

ECC.6.5.3.2 System Telephony supervisory tones indicate to the calling and receiving parties dial, engaged and ringing tones.

ECC.6.5.4 Obligations in respect of Control Telephony and System Telephony

ECC.6.5.4.1 Where **NGET** requires **Control Telephony**, **Users** are required to use the **Control Telephony** with **NGET** in respect of all **Connection Points** with the **National Electricity Transmission System** and in respect of all **Embedded Large Power Stations** and **Embedded HVDC Systems**. **NGET** will install **Control Telephony** at the **User's Control Point** where the **User's** telephony equipment is not capable of providing the required facilities or is otherwise incompatible with the **Transmission Control Telephony**. Details of and relating to the **Control Telephony** required are contained in the **Bilateral Agreement**.

ECC.6.5.4.2 Where in **NGET's** sole opinion the installation of **Control Telephony** is not practicable at a **User's Control Point(s)**, **NGET** shall specify in the **Bilateral Agreement** whether **System Telephony** is required. Where **System Telephony** is required by **NGET**, the **User** shall ensure that **System Telephony** is installed.

ECC.6.5.4.3 Where **System Telephony** is installed, **Users** are required to use the **System Telephony** with **NGET** in respect of those **Control Point(s)** for which it has been installed. Details of and relating to the **System Telephony** required are contained in the **Bilateral Agreement**.

ECC.6.5.4.4 Where **Control Telephony** or **System Telephony** is installed, routine testing of such facilities may be required by **NGET** (not normally more than once in any calendar month). The **User** and **NGET** shall use reasonable endeavours to agree a test programme and where **NGET** requests the assistance of the **User** in performing the agreed test programme the **User** shall provide such assistance.

ECC.6.5.4.5 **Control Telephony** and **System Telephony** shall only be used for the purposes of operational voice communication between **NGET** and the relevant **User**.

ECC.6.5.4.6 **Control Telephony** contains emergency calling functionality to be used for urgent operational communication only. Such functionality enables **NGET** and **Users** to utilise a priority call in the event of an emergency. **NGET** and **Users** shall only use such priority call functionality for urgent operational communications.

ECC.6.5.5 Technical Requirements for Control Telephony and System Telephony

ECC.6.5.5.1 Detailed information on the technical interfaces and support requirements for **Control Telephony** applicable in **NGET's Transmission Area** is provided in the **Control Telephony Electrical Standard** identified in the Annex to the **General Conditions**. Where additional information, or information in relation to **Control Telephony** applicable in Scotland, is requested by **Users**, this will be provided, where possible, by **NGET**.

ECC.6.5.5.2 **System Telephony** shall consist of a dedicated Public Switched Telephone Network telephone line that shall be installed and configured by the relevant **User**. **NGET** shall provide a dedicated free phone number (UK only), for the purposes of receiving incoming calls to **NGET**, which **Users** shall utilise for **System Telephony**. **System Telephony** shall only be utilised by the **NGET Control Engineer** and the **User's Responsible Engineer/Operator** for the purposes of operational communications.

ECC.6.5.6 Operational Metering

ECC.6.5.6.1 It is an essential requirement for **NGET** and **Network Operators** to have visibility of the real time output and status of indications of **User's Plant and Apparatus** so they can control the operation of the **System**.

ECC.6.5.6.2 **Type B, Type C and Type D Power Park Modules, HVDC Equipment, Network Operators and Non Embedded Customers** are required to be capable of exchanging operational metering data with **NGET** and **Relevant Transmission Licensees** (as applicable) with time stamping. Time stamping would generally be to a sampling rate of 1 second or better unless otherwise specified by **NGET** in the **Bilateral Agreement**.

Formatted: Highlight

ECC.6.5.6.3 **NGET** in coordination with the **Relevant Transmission Licensee** shall specify in the **Bilateral Agreement** the operational metering signals to be provided by the **EU Generator, HVDC System Owner, Network Operator or Non-Embedded Customer**. In the case of **Network Operators's and Non-Embedded Customers's, detailed specifications relating to the operational metering standards at EU Grid Supply Points and the data required are published as Electrical Standards** in the Annex to the **General Conditions**.

Formatted: Font: Not Bold

Formatted: Font: Not Bold

Formatted: Font: Bold

ECC.6.5.6.4 (a) **NGET** shall provide system control and data acquisition (SCADA) outstation interface equipment, each **EU Code User** shall provide such voltage, current, **Frequency, Active Power and Reactive Power** measurement outputs and plant status indications and alarms to the **Transmission SCADA** outstation interface equipment as required by **NGET** in accordance with the terms of the **Bilateral Agreement**. In the case of **OTSDUW**, the **User** shall provide such SCADA outstation interface equipment and voltage, current, **Frequency, Active Power and Reactive Power** measurement outputs and plant status indications and alarms to the SCADA outstation interface equipment as required by **NGET** in accordance with the terms of the **Bilateral Agreement**.

(b) For the avoidance of doubt, for **Active Power** and **Reactive Power** measurements, circuit breaker and disconnector status indications from:

(i) **CCGT Modules** from **Type B, Type C and Type D Power Generating Modules**, the outputs and status indications must each be provided to **NGET** on an individual **CCGT Unit** basis. In addition, where identified in the **Bilateral Agreement, Active Power and Reactive Power** measurements from **Unit Transformers** and/or **Station Transformers** must be provided.

(ii) For **Type B, Type C and Type D Power Park Modules** the outputs and status indications must each be provided to **NGET** on an individual **Power Park Module** basis. In addition, where identified in the **Bilateral Agreement, Active Power and Reactive Power** measurements from station transformers must be provided.

(iv) In respect of **OTSDUW Plant and Apparatus**, the outputs and status indications must be provided to **NGET** for each piece of electrical equipment. In addition, where identified in the **Bilateral Agreement, Active Power and Reactive Power** measurements at the **Interface Point** must be provided.

(c) For the avoidance of doubt, the requirements of ECC.6.5.6.4(a) in the case of a **Cascade Hydro Scheme** will be provided for each **Generating Unit** forming part of that **Cascade Hydro Scheme**. In the case of **Embedded Generating Units** forming part of a **Cascade Hydro Scheme** the data may be provided by means other than a **NGET SCADA** outstation located at the **Power Station**, such as, with the agreement of the **Network Operator** in whose system such **Embedded Generating Unit** is located, from the **Network Operator's** SCADA system to **NGET**. Details of such arrangements will be contained in the relevant **Bilateral Agreements** between **NGET** and the **Generator** and the **Network Operator**.

(d) In the case of a **Power Park Module**, additional energy input signals (e.g. wind speed, and wind direction) may be specified in the **Bilateral Agreement**. A **Power Available** signal will also be specified in the **Bilateral Agreement**. The signals would be used to establish the potential level of energy input from the **Intermittent Power Source** for monitoring pursuant to ECC.6.6.1 and **Ancillary Services** and will, in the case of a wind farm, be used to provide **NGET** with advanced warning of excess wind speed shutdown and to determine the level of **Headroom** available from **Power Park Modules** for the purposes of calculating response and reserve. For the avoidance of doubt, the **Power Available** signal would be automatically provided to **NGET** and represent the sum of the potential output of all available and operational **Power Park Units** within the **Power Park Module**. The refresh rate of the **Power Available** signal shall be specified in the **Bilateral Agreement**.

ECC.6.5.6.5 In addition to the requirements of the **Balancing Codes**, each **HVDC Converter** unit of an **HVDC system** shall be equipped with an automatic controller capable of receiving instructions from **NGET**. This automatic controller shall be capable of operating the **HVDC Converter** units of the **HVDC System** in a coordinated way. **NGET** shall specify the automatic controller hierarchy per **HVDC Converter** unit.

ECC.6.5.6.6 The automatic controller of the **HVDC System** referred to in paragraph ECC.6.5.6.5 shall be capable of sending the following signal types to **NGET** (where applicable) :

(a) operational metering signals, providing at least the following:

(i) start-up signals;

(ii) AC and DC voltage measurements;

(iii) AC and DC current measurements;

(iv) **Active** and **Reactive Power** measurements on the AC side;

(v) DC power measurements;

(vi) **HVDC Converter** unit level operation in a multi-pole type **HVDC Converter**;

(vii) elements and topology status; and

(viii) **Frequency Sensitive Mode**, **Limited Frequency Sensitive Mode Overfrequency** and **Limited Frequency Sensitive Mode Underfrequency Active Power** ranges (where applicable).

(b) alarm signals, providing at least the following:

(i) emergency blocking;

(ii) ramp blocking;

(iii) fast **Active Power** reversal (where applicable)

ECC.6.5.6.7 The automatic controller referred to in ECC.6.5.6.5 shall be capable of receiving the following signal types from NGET (where applicable) :

(a) operational metering signals, receiving at least the following:

(i) start-up command;

(ii) Active Power setpoints;

(iii) Frequency Sensitive Mode settings;

(iv) Reactive Power, voltage or similar setpoints;

(v) Reactive Power control modes;

(vi) power oscillation damping control; and

(b) alarm signals, receiving at least the following:

(i) emergency blocking command;

(ii) ramp blocking command;

(iii) Active Power flow direction; and

(iv) fast Active Power reversal command.

ECC.6.5.6.8 With regards to operational metering signals, the resolution and refresh rate required would be 1 second or better unless otherwise agreed with NGET

Instructor Facilities

ECC.6.5.7 The User shall accommodate Instructor Facilities provided by NGET for the receipt of operational messages relating to System conditions.

Electronic Data Communication Facilities

ECC.6.5.8 (a) All BM Participants must ensure that appropriate electronic data communication facilities are in place to permit the submission of data, as required by the Grid Code, to NGET.

(b) In addition,

(1) any User that wishes to participate in the Balancing Mechanism;

or

(2) any BM Participant in respect of its BM Units at a Power Station and the BM Participant is required to provide all Part 1 System Ancillary Services in accordance with ECC.8.1 (unless NGET has otherwise agreed)

must ensure that appropriate automatic logging devices are installed at the Control Points of its BM Units to submit data to and to receive instructions from NGET, as required by the Grid Code. For the avoidance of doubt, in the case of an Interconnector User the Control Point will be at the Control Centre of the appropriate Externally Interconnected System Operator.

(c) Detailed specifications of these required electronic facilities will be provided by NGET on request and they are listed as **Electrical Standards** in the Annex to the **General Conditions**.

Facsimile Machines

ECC.6.5.9 Each **User** and **NGET** shall provide a facsimile machine or machines:

(a) in the case of **Generators**, at the **Control Point** of each **Power Station** and at its **Trading Point**;

(b) in the case of **NGET** and **Network Operators**, at the **Control Centre(s)**; and

(c) in the case of **Non-Embedded Customers** and **HVDC Equipment** owners at the **Control Point**.

Each **User** shall notify, prior to connection to the **System** of the **User's Plant and Apparatus**, **NGET** of its or their telephone number or numbers, and will notify **NGET** of any changes. Prior to connection to the **System** of the **User's Plant and Apparatus** **NGET** shall notify each **User** of the telephone number or numbers of its facsimile machine or machines and will notify any changes.

ECC.6.5.10 Busbar Voltage

NGET shall, subject as provided below, provide each **Generator** or **HVDC System Owner** at each **Grid Entry Point** where one of its **Power Stations** or **HVDC Systems** is connected with appropriate voltage signals to enable the **Generator** or **HVDC System** owner to obtain the necessary information to permit its **Power Generating Modules** (including **DC Connected Power Park Modules**) or **HVDC System** to be **Synchronised** to the **National Electricity Transmission System**. The term "**voltage signal**" shall mean in this context, a point of connection on (or wire or wires from) a relevant part of **Transmission Plant** and/or **Apparatus** at the **Grid Entry Point**, to which the **Generator** or **HVDC System Owner**, with **NGET's** agreement (not to be unreasonably withheld) in relation to the **Plant** and/or **Apparatus** to be attached, will be able to attach its **Plant** and/or **Apparatus** (normally a wire or wires) in order to obtain measurement outputs in relation to the busbar.

ECC.6.5.11 Bilingual Message Facilities

(a) A Bilingual Message Facility is the method by which the **User's Responsible Engineer/Operator**, the **Externally Interconnected System Operator** and **NGET Control Engineers** communicate clear and unambiguous information in two languages for the purposes of control of the **Total System** in both normal and emergency operating conditions.

(b) A Bilingual Message Facility, where required, will provide up to two hundred pre-defined messages with up to five hundred and sixty characters each. A maximum of one minute is allowed for the transmission to, and display of, the selected message at any destination. The standard messages must be capable of being displayed at any combination of locations and can originate from any of these locations. Messages displayed in the UK will be displayed in the English language.

(c) Detailed information on a Bilingual Message Facility and suitable equipment required for individual **User** applications will be provided by **NGET** upon request.

ECC.6.6 Monitoring

ECC.6.6.1 System Monitoring

ECC.6.6.1.1 Each **Type C** and **Type D Power Generating Module** including **DC Connected Power Park Modules** shall be equipped with a facility to provide fault recording and monitoring of dynamic system behaviour. These requirements are necessary to record conditions during **System** faults and detect poorly damped power oscillations. This facility shall record the following parameters:

- voltage,
- **Active Power**,
- **Reactive Power**, and
- **Frequency**.

ECC.6.6.1.2 Detailed specifications for fault recording and dynamic system monitoring equipment including triggering criteria and sample rates are listed as **Electrical Standards** in the **Annex** to the **General Conditions**. For Dynamic System Monitoring, the specification for the communication protocol and recorded data shall also be included in the **Electrical Standard**.

ECC.6.6.1.3 **NGET** in coordination with the **Relevant Transmission Licensee** shall specify any requirements for **Power Quality Monitoring** in the **Bilateral Agreement**. The power quality parameters to be monitored, the communication protocols for the recorded data and the time frames for compliance shall be agreed between **NGET**, the **Relevant Transmission Licensee** and **EU Generator**.

ECC.6.6.1.4 **HVDC Systems** shall be equipped with a facility to provide fault recording and dynamic system behaviour monitoring of the following parameters for each of its **HVDC Converter Stations**:

- (a) AC and DC voltage;
- (b) AC and DC current;
- (c) **Active Power**;
- (d) **Reactive Power**; and
- (e) **Frequency**.

ECC.6.6.1.5 **NGET** in coordination with the **Relevant Transmission Licensee** may specify quality of supply parameters to be complied with by the **HVDC System**, provided a reasonable prior notice is given.

ECC.6.6.1.6 The particulars of the fault recording equipment referred to in ECC.6.6.1.4, including analogue and digital channels, the settings, including triggering criteria and the sampling rates, shall be agreed between the **HVDC System Owner** and **NGET** in coordination with the **Relevant Transmission Licensee**.

ECC.6.6.1.7 All dynamic system behaviour monitoring equipment shall include an oscillation trigger, specified by **NGET**, in coordination with the **Relevant Transmission Licensee**, with the purpose of detecting poorly damped power oscillations.

ECC.6.6.1.8 The facilities for quality of supply and dynamic system behaviour monitoring shall include arrangements for the **HVDC System Owner** and **NGET** and/or **Relevant Transmission Licensee** to access the information electronically. The communications protocols for recorded data shall be agreed between the **HVDC System Owner**, **NGET** and the **Relevant Transmission Licensee**.

ECC.6.6.2 **Frequency Response Monitoring**

ECC.6.6.2.1 Each **Type C** and **Type D Power Generating Module** including **DC Connected Power Park Modules** shall be fitted with equipment capable of monitoring the real time **Active Power** output of a **Power Generating Module** when operating in **Frequency Sensitive Mode**.

ECC.6.6.2.2

Detailed specifications of the **Active Power Frequency** response requirements including the communication requirements are listed as **Electrical Standards** in the **Annex** to the **General Conditions**.

ECC.6.6.2.3 **NGET** in co-ordination with the **Relevant Transmission Licensee** shall specify additional signals to be provided by the **EU Generator** by monitoring and recording devices in order to verify the performance of the **Active Power Frequency** response provision of participating **Power Generating Modules**.

ECC.6.6.3 Compliance Monitoring

ECC.6.6.3.1 For all on site monitoring by **NGET** of witnessed tests pursuant to the **CP** or **OC5** or **ECP** the **User** shall provide suitable test signals as outlined in either **OC5.A.1** or **ECP.A.4** (as applicable).

ECC.6.6.3.2 The signals which shall be provided by the **User** to **NGET** for onsite monitoring shall be of the following resolution, unless otherwise agreed by **NGET**:

- (i) 1 Hz for reactive range tests
- (ii) 10 Hz for frequency control tests
- (iii) 100 Hz for voltage control tests

ECC.6.6.3.3 The **User** will provide all relevant signals for this purpose in the form of d.c. voltages within the range -10V to +10V. In exceptional circumstances some signals may be accepted as d.c. voltages within the range -60V to +60V with prior agreement between the **User** and **NGET**. All signals shall:

- (i) in the case of an **Onshore Power Generating Module** or **Onshore HVDC Converter Station**, be suitably terminated in a single accessible location at the **Generator** or **HVDC Converter Station** owner's site.
- (ii) in the case of an **Offshore Power Generating Module** and **OTSDUW Plant and Apparatus**, be transmitted onshore without attenuation, delay or filtering which would result in the inability to fully demonstrate the objectives of the test, or identify any potential safety or plant instability issues, and be suitably terminated in a single robust location normally located at or near the onshore **Interface Point** of the **Offshore Transmission System** to which it is connected.

ECC.6.6.3.4 All signals shall be suitably scaled across the range. The following scaling would (unless **NGET** notify the **User** otherwise) be acceptable to **NGET**:

- (a) 0MW to **Maximum Capacity** or **Interface Point Capacity** 0-8V dc
- (b) Maximum leading **Reactive Power** to maximum lagging **Reactive Power** -8 to 8V dc
- (c) 48 – 52Hz as -8 to 8V dc
- (d) Nominal terminal or connection point voltage -10% to +10% as -8 to 8V dc

ECC.6.6.3.5 The **User** shall provide to **NGET** a 230V power supply adjacent to the signal terminal location.

ECC.7 SITE RELATED CONDITIONS

ECC.7.1 Not used.

ECC.7.2 Responsibilities For Safety

ECC.7.2.1 In England and Wales, any User entering and working on its Plant and/or Apparatus (including, until the OTSUA Transfer Time, any OTSUA) on a Transmission Site will work to the Safety Rules of NGET.

In Scotland or Offshore, any User entering and working on its Plant and/or Apparatus (including, until the OTSUA Transfer Time, any OTSUA) on a Transmission Site will work to the Safety Rules of the Relevant Transmission Licensee, as advised by NGET.

ECC.7.2.2 NGET entering and working on Transmission Plant and/or Apparatus on a User Site will work to the User's Safety Rules. For User Sites in Scotland or Offshore, NGET shall procure that the Relevant Transmission Licensee entering and working on Transmission Plant and/or Apparatus on a User Site will work to the User's Safety Rules.

ECC.7.2.3 A User may, with a minimum of six weeks notice, apply to NGET for permission to work according to that Users own Safety Rules when working on its Plant and/or Apparatus on a Transmission Site rather than those set out in ECC.7.2.1. If NGET is of the opinion that the User's Safety Rules provide for a level of safety commensurate with those set out in ECC.7.2.1, NGET will notify the User, in writing, that, with effect from the date requested by the User, the User may use its own Safety Rules when working on its Plant and/or Apparatus on the Transmission Site. For a Transmission Site in Scotland or Offshore, in forming its opinion, NGET will seek the opinion of the Relevant Transmission Licensee. Until receipt of such written approval from NGET, the User will continue to use the Safety Rules as set out in ECC.7.2.1.

ECC.7.2.4 In the case of a User Site in England and Wales, NGET may, with a minimum of six weeks notice, apply to a User for permission to work according to NGET's Safety Rules when working on Transmission Plant and/or Apparatus on that User Site, rather than the User's Safety Rules. If the User is of the opinion that NGET's Safety Rules provide for a level of safety commensurate with that of that User's Safety Rules, it will notify NGET, in writing, that, with the effect from the date requested by NGET, NGET may use its own Safety Rules when working on its Transmission Plant and/or Apparatus on that User Site. Until receipt of such written approval from the User, NGET shall continue to use the User's Safety Rules.

In the case of a User Site in Scotland or Offshore, NGET may, with a minimum of six weeks notice, apply to a User for permission for the Relevant Transmission Licensee to work according to the Relevant Transmission Licensee's Safety Rules when working on Transmission Plant and/or Apparatus on that User Site, rather than the User's Safety Rules. If the User is of the opinion that the Relevant Transmission Licensee's Safety Rules, provide for a level of safety commensurate with that of that User's Safety Rules, it will notify NGET, in writing, that, with effect from the date requested by NGET, that the Relevant Transmission Licensee may use its own Safety Rules when working on its Transmission Plant and/or Apparatus on that User's Site. Until receipt of such written approval from the User, NGET shall procure that the Relevant Transmission Licensee shall continue to use the User's Safety Rules.

ECC.7.2.5 For a **Transmission Site** in England and Wales, if **NGET** gives its approval for the **User's Safety Rules** to apply to the **User** when working on its **Plant** and/or **Apparatus**, that does not imply that the **User's Safety Rules** will apply to entering the **Transmission Site** and access to the **User's Plant** and/or **Apparatus** on that **Transmission Site**. Bearing in mind **NGET's** responsibility for the whole **Transmission Site**, entry and access will always be in accordance with **NGET's** site access procedures. For a **User Site** in England and Wales, if the **User** gives its approval for **NGET's Safety Rules** to apply to **NGET** when working on its **Plant** and **Apparatus**, that does not imply that **NGET's Safety Rules** will apply to entering the **User Site**, and access to the **Transmission Plant** and **Apparatus** on that **User Site**. Bearing in mind the **User's** responsibility for the whole **User Site**, entry and access will always be in accordance with the **User's** site access procedures.

For a **Transmission Site** in Scotland or **Offshore**, if **NGET** gives its approval for the **User's Safety Rules** to apply to the **User** when working on its **Plant** and/or **Apparatus**, that does not imply that the **User's Safety Rules** will apply to entering the **Transmission Site** and access to the **User's Plant** and/or **Apparatus** on that **Transmission Site**. Bearing in mind the **Relevant Transmission Licensee's** responsibility for the whole **Transmission Site**, entry and access will always be in accordance with the **Relevant Transmission Licensee's** site access procedures. For a **User Site** in Scotland or **Offshore**, if the **User** gives its approval for **Relevant Transmission Licensee Safety Rules** to apply to the **Relevant Transmission Licensee** when working on its **Plant** and **Apparatus**, that does not imply that the **Relevant Transmission Licensee's Safety Rules** will apply to entering the **User Site**, and access to the **Transmission Plant** and **Apparatus** on that **User Site**. Bearing in mind the **User's** responsibility for the whole **User Site**, entry and access will always be in accordance with the **User's** site access procedures.

ECC.7.2.6 For **User Sites** in England and Wales, **Users** shall notify **NGET** of any **Safety Rules** that apply to **NGET's** staff working on **User Sites**. For **Transmission Sites** in England and Wales, **NGET** shall notify **Users** of any **Safety Rules** that apply to the **User's** staff working on the **Transmission Site**.

For **User Sites** in Scotland or **Offshore**, **Users** shall notify **NGET** of any **Safety Rules** that apply to the **Relevant Transmission Licensee's** staff working on **User Sites**. For **Transmission Sites** in Scotland or **Offshore** **NGET** shall procure that the **Relevant Transmission Licensee** shall notify **Users** of any **Safety Rules** that apply to the **User's** staff working on the **Transmission Site**.

ECC.7.2.7 Each **Site Responsibility Schedule** must have recorded on it the **Safety Rules** which apply to each item of **Plant** and/or **Apparatus**.

ECC.7.2.8 In the case of **OTSUA** a **User Site** or **Transmission Site** shall, for the purposes of this **ECC.7.2**, include a site at which there is an **Interface Point** until the **OTSUA Transfer Time** when it becomes part of the **National Electricity Transmission System**.

ECC.7.3 Site Responsibility Schedules

ECC.7.3.1 In order to inform site operational staff and **NGET Control Engineers** of agreed responsibilities for **Plant** and/or **Apparatus** at the operational interface, a **Site Responsibility Schedule** shall be produced for **Connection Sites** (and in the case of **OTSUA**, until the **OTSUA Transfer Time**, **Interface Sites**) in England and Wales for **NGET** and **Users** with whom they interface, and for **Connection Sites** (and in the case of **OTSUA**, until the **OTSUA Transfer Time**, **Interface Sites**) in Scotland or **Offshore** for **NGET**, the **Relevant Transmission Licensee** and **Users** with whom they interface.

ECC.7.3.2 The format, principles and basic procedure to be used in the preparation of **Site Responsibility Schedules** are set down in Appendix 1.

ECC.7.4 Operation And Gas Zone Diagrams

Operation Diagrams

ECC.7.4.1 An **Operation Diagram** shall be prepared for each **Connection Site** at which a **Connection Point** exists (and in the case of **OTSDUW Plant and Apparatus**, by **User's** for each **Interface Point**) using, where appropriate, the graphical symbols shown in Part 1A of Appendix 2. **Users** should also note that the provisions of **OC11** apply in certain circumstances.

ECC.7.4.2 The **Operation Diagram** shall include all **HV Apparatus** and the connections to all external circuits and incorporate numbering, nomenclature and labelling, as set out in **OC11**. At those **Connection Sites** (or in the case of **OTSDUW Plant and Apparatus, Interface Points**) where gas-insulated metal enclosed switchgear and/or other gas-insulated **HV Apparatus** is installed, those items must be depicted within an area delineated by a chain dotted line which intersects gas-zone boundaries. The nomenclature used shall conform with that used on the relevant **Connection Site** and circuit (and in the case of **OTSDUW Plant and Apparatus, Interface Point** and circuit). The **Operation Diagram** (and the list of technical details) is intended to provide an accurate record of the layout and circuit interconnections, ratings and numbering and nomenclature of **HV Apparatus** and related **Plant**.

ECC.7.4.3 A non-exhaustive guide to the types of **HV Apparatus** to be shown in the **Operation Diagram** is shown in Part 2 of Appendix 2, together with certain basic principles to be followed unless equivalent principles are approved by **NGET**.

Gas Zone Diagrams

ECC.7.4.4 A **Gas Zone Diagram** shall be prepared for each **Connection Site** at which a **Connection Point** (and in the case of **OTSDUW Plant and Apparatus**, by **User's** for an **Interface Point**) exists where gas-insulated switchgear and/or other gas-insulated **HV Apparatus** is utilised. They shall use, where appropriate, the graphical symbols shown in Part 1B of Appendix 2.

ECC.7.4.5 The nomenclature used shall conform with that used in the relevant **Connection Site** and circuit (and in the case of **OTSDUW Plant and Apparatus**, relevant **Interface Point** and circuit).

ECC.7.4.6 The basic principles set out in Part 2 of Appendix 2 shall be followed in the preparation of **Gas Zone Diagrams** unless equivalent principles are approved by **NGET**.

Preparation of Operation and Gas Zone Diagrams for Users' Sites and Transmission Interface Sites

ECC.7.4.7 In the case of a **User Site**, the **User** shall prepare and submit to **NGET**, an **Operation Diagram** for all **HV Apparatus** on the **User** side of the **Connection Point** (and in the case of **OTSDUW Plant and Apparatus**, on what will be the **Offshore Transmission** side of the **Connection Point** and the **Interface Point**) and **NGET** shall provide the **User** with an **Operation Diagram** for all **HV Apparatus** on the **Transmission** side of the **Connection Point** (and in the case of **OTSDUW Plant and Apparatus** on what will be the **Onshore Transmission** side of the **Interface Point**, in accordance with the timing requirements of the **Bilateral Agreement** and/or **Construction Agreement** prior to the **Completion Date** under the **Bilateral Agreement** and/or **Construction Agreement**.

ECC.7.4.8 The User will then prepare, produce and distribute, using the information submitted on the User's Operation Diagram and NGET Operation Diagram, a composite Operation Diagram for the complete Connection Site (and in the case of OTSDUW Plant and Apparatus, Interface Point), also in accordance with the timing requirements of the Bilateral Agreement and/or Construction Agreement.

ECC.7.4.9 The provisions of ECC.7.4.7 and ECC.7.4.8 shall apply in relation to Gas Zone Diagrams where gas-insulated switchgear and/or other gas-insulated HV Apparatus is utilised.

Preparation of Operation and Gas Zone Diagrams for Transmission Sites

ECC.7.4.10 In the case of an Transmission Site, the User shall prepare and submit to NGET an Operation Diagram for all HV Apparatus on the User side of the Connection Point, in accordance with the timing requirements of the Bilateral Agreement and/or Construction Agreement.

ECC.7.4.11 NGET will then prepare, produce and distribute, using the information submitted on the User's Operation Diagram, a composite Operation Diagram for the complete Connection Site, also in accordance with the timing requirements of the Bilateral Agreement and/or Construction Agreement.

ECC.7.4.12 The provisions of ECC.7.4.10 and ECC.7.4.11 shall apply in relation to Gas Zone Diagrams where gas-insulated switchgear and/or other gas-insulated HV Apparatus is utilised.

Changes to Operation and Gas Zone Diagrams

ECC.7.4.13.1 When NGET has decided that it wishes to install new HV Apparatus or it wishes to change the existing numbering or nomenclature of Transmission HV Apparatus at a Transmission Site, NGET will (unless it gives rise to a Modification under the CUSC, in which case the provisions of the CUSC as to the timing apply) one month prior to the installation or change, send to each such User a revised Operation Diagram of that Transmission Site, incorporating the new Transmission HV Apparatus to be installed and its numbering and nomenclature or the changes, as the case may be. OC11 is also relevant to certain Apparatus.

ECC.7.4.13.2 When a User has decided that it wishes to install new HV Apparatus, or it wishes to change the existing numbering or nomenclature of its HV Apparatus at its User Site, the User will (unless it gives rise to a Modification under the CUSC, in which case the provisions of the CUSC as to the timing apply) one month prior to the installation or change, send to NGET a revised Operation Diagram of that User Site incorporating the EU Code User HV Apparatus to be installed and its numbering and nomenclature or the changes as the case may be. OC11 is also relevant to certain Apparatus.

ECC.7.4.13.3 The provisions of ECC.7.4.13.1 and ECC.7.4.13.2 shall apply in relation to Gas Zone Diagrams where gas-insulated switchgear and/or other gas-insulated HV Apparatus is installed.

Validity

ECC.7.4.14 (a) The composite Operation Diagram prepared by NGET or the User, as the case may be, will be the definitive Operation Diagram for all operational and planning activities associated with the Connection Site. If a dispute arises as to the accuracy of the composite Operation Diagram, a meeting shall be held at the Connection Site, as soon as reasonably practicable, between NGET and the User, to endeavour to resolve the matters in dispute.

(b) The composite **Operation Diagram** prepared by NGET or the User, as the case may be, will be the definitive **Operation Diagram** for all operational and planning activities associated with the **Interface Point** until the **OTSUA Transfer Time**. If a dispute arises as to the accuracy of the composite **Operation Diagram** prior to the **OTSUA Transfer Time**, a meeting shall be held at the **Interface Point**, as soon as reasonably practicable, between NGET and the User, to endeavour to resolve the matters in dispute.

(c) An equivalent rule shall apply for **Gas Zone Diagrams** where they exist for a **Connection Site**.

ECC.7.4.15 In the case of **OTSUA**, a **User Site** and **Transmission Site** shall, for the purposes of this ECC.7.4, include a site at which there is an **Interface Point** until the **OTSUA Transfer Time** when it becomes part of the **National Electricity Transmission System** and references to **HV Apparatus** in this ECC.7.4 shall include references to **HV OTSUA**.

ECC.7.5 Site Common Drawings

ECC.7.5.1 **Site Common Drawings** will be prepared for each **Connection Site** (and in the case of **OTSDUW**, each **Interface Point**) and will include **Connection Site** (and in the case of **OTSDUW**, **Interface Point**) layout drawings, electrical layout drawings, common **Protection/control** drawings and common services drawings.

Preparation of Site Common Drawings for a User Site and Transmission Interface Site

ECC.7.5.2 In the case of a **User Site**, NGET shall prepare and submit to the User, **Site Common Drawings** for the **Transmission** side of the **Connection Point** (and in the case of **OTSDUW Plant and Apparatus**, on what will be the **Onshore Transmission** side of the **Interface Point**.) and the User shall prepare and submit to NGET, **Site Common Drawings** for the **User** side of the **Connection Point** (and in the case of **OTSDUW**, on what will be the **Offshore Transmission** side of the **Interface Point**) in accordance with the timing requirements of the **Bilateral Agreement** and/or **Construction Agreement**.

ECC.7.5.3 The User will then prepare, produce and distribute, using the information submitted on the **Transmission Site Common Drawings**, **Site Common Drawings** for the complete **Connection Site** (and in the case of **OTSDUW**, **Interface Point**) in accordance with the timing requirements of the **Bilateral Agreement** and/or **Construction Agreement**.

Preparation of Site Common Drawings for a Transmission Site

ECC.7.5.4 In the case of a **Transmission Site**, the User will prepare and submit to NGET **Site Common Drawings** for the **User** side of the **Connection Point** in accordance with the timing requirements of the **Bilateral Agreement** and/or **Construction Agreement**.

ECC.7.5.5 NGET will then prepare, produce and distribute, using the information submitted in the **User's Site Common Drawings**, **Site Common Drawings** for the complete **Connection Site** in accordance with the timing requirements of the **Bilateral Agreement** and/or **Construction Agreement**.

ECC.7.5.6 When a User becomes aware that it is necessary to change any aspect of the **Site Common Drawings** at a **Connection Site** (and in the case of **OTSDUW**, **Interface Point**) it will:

(a) if it is a **User Site**, as soon as reasonably practicable, prepare, produce and distribute revised **Site Common Drawings** for the complete **Connection Site** (and in the case of **OTSDUW**, **Interface Point**); and

(b) if it is a **Transmission Site**, as soon as reasonably practicable, prepare and submit to **NGET revised Site Common Drawings** for the **User** side of the **Connection Point** (and in the case of **OTSDUW, Interface Point**) and **NGET** will then, as soon as reasonably practicable, prepare, produce and distribute, using the information submitted in the **User's Site Common Drawings**, revised **Site Common Drawings** for the complete **Connection Site** (and in the case of **OTSDUW, Interface Point**).

In either case, if in the **User's** reasonable opinion the change can be dealt with by it notifying **NGET** in writing of the change and for each party to amend its copy of the **Site Common Drawings** (or where there is only one set, for the party holding that set to amend it), then it shall so notify and each party shall so amend. If the change gives rise to a **Modification** under the **CUSC**, the provisions of the **CUSC** as to timing will apply.

ECC.7.5.7 When **NGET** becomes aware that it is necessary to change any aspect of the **Site Common Drawings** at a **Connection Site**(and in the case of **OTSDUW, Interface Point**) it will:

(a) if it is a **Transmission Site**, as soon as reasonably practicable, prepare, produce and distribute revised **Site Common Drawings** for the complete **Connection Site** (and in the case of **OTSDUW, Interface Point**); and

(b) if it is a **User Site**, as soon as reasonably practicable, prepare and submit to the **User** revised **Site Common Drawings** for the **Transmission** side of the **Connection Point** (in the case of **OTSDUW, Interface Point**) and the **User** will then, as soon as reasonably practicable, prepare, produce and distribute, using the information submitted in the **Transmission Site Common Drawings**, revised **Site Common Drawings** for the complete **Connection Site** (and in the case of **OTSDUW, Interface Point**).

In either case, if in **NGET's** reasonable opinion the change can be dealt with by it notifying the **User** in writing of the change and for each party to amend its copy of the **Site Common Drawings** (or where there is only one set, for the party holding that set to amend it), then it shall so notify and each party shall so amend. If the change gives rise to a **Modification** under the **CUSC**, the provisions of the **CUSC** as to timing will apply.

Validity

ECC.7.5.8 (a) The **Site Common Drawings** for the complete **Connection Site** prepared by the **User** or **NGET**, as the case may be, will be the definitive **Site Common Drawings** for all operational and planning activities associated with the **Connection Site**. If a dispute arises as to the accuracy of the **Site Common Drawings**, a meeting shall be held at the **Site**, as soon as reasonably practicable, between **NGET** and the **User**, to endeavour to resolve the matters in dispute.

(b) The **Site Common Drawing** prepared by **NGET** or the **User**, as the case may be, will be the definitive **Site Common Drawing** for all operational and planning activities associated with the **Interface Point** until the **OTSUA Transfer Time**. If a dispute arises as to the accuracy of the composite **Operation Diagram** prior to the **OTSUA Transfer Time**, a meeting shall be held at the **Interface Point**, as soon as reasonably practicable, between **NGET** and the **User**, to endeavour to resolve the matters in dispute.

ECC.7.5.9 In the case of **OTSUA**, a **User Site** and **Transmission Site** shall, for the purposes of this **ECC.7.5**, include a site at which there is an **Interface Point** until the **OTSUA Transfer Time** when it becomes part of the **National Electricity Transmission System**.

ECC.7.6 Access

- ECC.7.6.1 The provisions relating to access to **Transmission Sites** by **Users**, and to **Users' Sites** by **Transmission Licensees**, are set out in each **Interface Agreement** (or in the case of **Interfaces Sites** prior to the **OTSUA Transfer Time** agreements in similar form) with, for **Transmission Sites** in England and Wales, **NGET** and each **User**, and for **Transmission Sites** in Scotland and **Offshore**, the **Relevant Transmission Licensee** and each **User**.
- ECC.7.6.2 In addition to those provisions, where a **Transmission Site** in England and Wales contains exposed **HV** conductors, unaccompanied access will only be granted to individuals holding an **Authority for Access** issued by **NGET** and where a **Transmission Site** in Scotland or **Offshore** contains exposed **HV** conductors, unaccompanied access will only be granted to individuals holding an **Authority for Access** issued by the **Relevant Transmission Licensee**.
- ECC.7.6.3 The procedure for applying for an **Authority for Access** is contained in the **Interface Agreement**.
- ECC.7.7 Maintenance Standards
- ECC.7.7.1 It is the **User's** responsibility to ensure that all its **Plant** and **Apparatus** (including, until the **OTSUA Transfer Time**, any **OTSUA**) on a **Transmission Site** is tested and maintained adequately for the purpose for which it is intended, and to ensure that it does not pose a threat to the safety of any **Transmission Plant, Apparatus** or personnel on the **Transmission Site**. **NGET** will have the right to inspect the test results and maintenance records relating to such **Plant** and **Apparatus** at any time
- ECC.7.7.2 For **User Sites** in England and Wales, **NGET** has a responsibility to ensure that all **Transmission Plant** and **Apparatus** on a **User Site** is tested and maintained adequately for the purposes for which it is intended and to ensure that it does not pose a threat to the safety of any **User's Plant, Apparatus** or personnel on the **User Site**.
- For **User Sites** in Scotland and **Offshore**, **NGET** shall procure that the **Relevant Transmission Licensee** has a responsibility to ensure that all **Transmission Plant** and **Apparatus** on a **User Site** is tested and maintained adequately for the purposes for which it is intended and to ensure that it does not pose a threat to the safety of any **User's Plant, Apparatus** or personnel on the **User Site**.
- The **User** will have the right to inspect the test results and maintenance records relating to such **Plant** and **Apparatus** on its **User Site** at any time.
- ECC.7.8 Site Operational Procedures
- ECC.7.8.1 **NGET** and **Users** with an interface with **NGET**, must make available staff to take necessary **Safety Precautions** and carry out operational duties as may be required to enable work/testing to be carried out and for the operation of **Plant** and **Apparatus** (including, prior to the **OTSUA Transfer Time**, any **OTSUA**) connected to the **Total System**.
- ECC.7.9 **Generators** and **HVDC System** owners shall provide a **Control Point** in respect of each **Power Station** directly connected to the **National Electricity Transmission System** and **Embedded Large Power Station** or **HVDC System** to receive and act upon instructions pursuant to OC7 and BC2 at all times that **Power Generating Modules** at the **Power Station** are generating or available to generate or **HVDC Systems** are importing or exporting or available to do so. The **Control Point** shall be continuously manned except where the **Bilateral Agreement** in respect of such **Embedded Power Station** specifies that compliance with BC2 is not required, where the **Control Point** shall be manned between the hours of 0800 and 1800 each day.

ECC.8 ANCILLARY SERVICES

ECC.8.1 System Ancillary Services

The ECC contain requirements for the capability for certain **Ancillary Services**, which are needed for **System** reasons ("**System Ancillary Services**"). There follows a list of these **System Ancillary Services**, together with the paragraph number of the ECC (or other part of the **Grid Code**) in which the minimum capability is required or referred to. The list is divided into two categories: Part 1 lists the **System Ancillary Services** which

- (a) **Generators** in respect of **Type C** and **Type D Power Generating Modules** (including **DC Connected Power Park Modules**) are obliged to provide; and,
- (b) **HVDC System Owners** are obliged to have the capability to supply;
- (c) **Generators** in respect of **Medium Power Stations** (except **Embedded Medium Power Stations**) are obliged to provide in respect of **Reactive Power** only;

and Part 2 lists the **System Ancillary Services** which **Generators** will provide only if agreement to provide them is reached with **NGET**;

Part 1

- (a) **Reactive Power** supplied (in accordance with ECC.6.3.2)
- (b) **Frequency Control** by means of **Frequency** sensitive generation - ECC.6.3.7 and BC3.5.1

Part 2

- (c) **Frequency Control** by means of **Fast Start** - ECC.6.3.14
- (d) **Black Start Capability** - ECC.6.3.5
- (e) **System to Generator Operational Intertipping**

ECC.8.2 Commercial Ancillary Services

Other **Ancillary Services** are also utilised by **NGET** in operating the **Total System** if these have been agreed to be provided by a **User** (or other person) under an **Ancillary Services Agreement** or under a **Bilateral Agreement**, with payment being dealt with under an **Ancillary Services Agreement** or in the case of **Externally Interconnected System Operators** or **Interconnector Users**, under any other agreement (and in the case of **Externally Interconnected System Operators** and **Interconnector Users** includes ancillary services equivalent to or similar to **System Ancillary Services**) ("**Commercial Ancillary Services**"). The capability for these **Commercial Ancillary Services** is set out in the relevant **Ancillary Services Agreement** or **Bilateral Agreement** (as the case may be).

APPENDIX E1 - SITE RESPONSIBILITY SCHEDULES

FORMAT, PRINCIPLES AND BASIC PROCEDURE TO BE USED IN THE PREPARATION OF SITE RESPONSIBILITY SCHEDULES

ECC.A.1.1 Principles

Types of Schedules

ECC.A.1.1.1 At all **Complexes** (which in the context of this ECC shall include, **Interface Sites** until the **OTSUA Transfer Time**) the following **Site Responsibility Schedules** shall be drawn up using the relevant proforma attached or with such variations as may be agreed between **NGET** and **Users**, but in the absence of agreement the relevant proforma attached will be used. In addition, in the case of **OTSDUW Plant and Apparatus**, and in readiness for the **OTSUA Transfer Time**, the **User** shall provide **NGET** with the necessary information such that **Site Responsibility Schedules** in this form can be prepared by the **Relevant Transmission Licensees** for the **Transmission Interface Site**:

- (a) Schedule of **HV Apparatus**
- (b) Schedule of **Plant, LV/MV Apparatus**, services and supplies;
- (c) Schedule of telecommunications and measurements **Apparatus**.

Other than at **Power Generating Module** (including **DC Connected Power Park Modules**) and **Power Station** locations, the schedules referred to in (b) and (c) may be combined.

New Connection Sites

ECC.A.1.1.2 In the case of a new **Connection Site** each **Site Responsibility Schedule** for a **Connection Site** shall be prepared by **NGET** in consultation with relevant **Users** at least 2 weeks prior to the **Completion Date** (or, where the **OTSUA** is to become **Operational** prior to the **OTSUA Transfer Time**, an alternative date) under the **Bilateral Agreement** and/or **Construction Agreement** for that **Connection Site** (which may form part of a **Complex**). In the case of a new **Interface Site** where the **OTSUA** is to become **Operational** prior to the **OTSUA Transfer Time** each **Site Responsibility Schedule** for an **Interface Site** shall be prepared by **NGET** in consultation with relevant **Users** at least 2 weeks prior to the **Completion Date** under the **Bilateral Agreement** and/or **Construction Agreement** for that **Interface Site** (which may form part of a **Complex**) (and references to and requirements placed on "**Connection Site**" in this ECC shall also be read as "**Interface Site**" where the context requires and until the **OTSUA Transfer Time**). Each **User** shall, in accordance with the timing requirements of the **Bilateral Agreement** and/or **Construction Agreement**, provide information to **NGET** to enable it to prepare the **Site Responsibility Schedule**.

Sub-division

ECC.A.1.1.3 Each **Site Responsibility Schedule** will be subdivided to take account of any separate **Connection Sites** on that **Complex**.

Scope

ECC.A.1.1.4 Each **Site Responsibility Schedule** shall detail for each item of **Plant and Apparatus**:

- (a) **Plant/Apparatus** ownership;
- (b) Site Manager (Controller) (except in the case of **Plant/Apparatus** located in **SPT's Transmission Area**);

(c) Safety issues comprising applicable **Safety Rules** and **Control Person** or other responsible person (**Safety Co-ordinator**), or such other person who is responsible for safety;

(d) Operations issues comprising applicable **Operational Procedures** and control engineer;

(e) Responsibility to undertake statutory inspections, fault investigation and maintenance.

Each **Connection Point** shall be precisely shown.

Detail

ECC.A.1.1.5 (a) In the case of **Site Responsibility Schedules** referred to in ECC.A.1.1.1(b) and (c), with the exception of **Protection Apparatus** and **Intertrip Apparatus** operation, it will be sufficient to indicate the responsible **User** or **Transmission Licensee**, as the case may be.

(b) In the case of the **Site Responsibility Schedule** referred to in ECC.A.1.1.1(a) and for **Protection Apparatus** and **Intertrip Apparatus**, the responsible management unit must be shown in addition to the **User** or **Transmission Licensee**, as the case may be.

ECC.A.1.1.6 The **HV Apparatus Site Responsibility Schedule** for each **Connection Site** must include lines and cables emanating from or traversing¹ the **Connection Site**.

Issue Details

ECC.A.1.1.7 Every page of each **Site Responsibility Schedule** shall bear the date of issue and the issue number.

Accuracy Confirmation

ECC.A.1.1.8 When a **Site Responsibility Schedule** is prepared it shall be sent by **NGET** to the **Users** involved for confirmation of its accuracy.

ECC.A.1.1.9 The **Site Responsibility Schedule** shall then be signed on behalf of **NGET** by its **Responsible Manager** (see ECC.A.1.1.16) and on behalf of each **User** involved by its **Responsible Manager** (see ECC.A.1.1.16), by way of written confirmation of its accuracy. For **Connection Sites** in Scotland or **Offshore**, the **Site Responsibility Schedule** will also be signed on behalf of the **Relevant Transmission Licensee** by its **Responsible Manager**.

Distribution and Availability

ECC.A.1.1.10 Once signed, two copies will be distributed by **NGET**, not less than two weeks prior to its implementation date, to each **User** which is a party on the **Site Responsibility Schedule**, accompanied by a note indicating the issue number and the date of implementation.

ECC.A.1.1.11 **NGET** and **Users** must make the **Site Responsibility Schedules** readily available to operational staff at the **Complex** and at the other relevant control points.

Alterations to Existing Site Responsibility Schedules

¹ Details of circuits traversing the **Connection Site** are only needed from the date which is the earlier of the date when the **Site Responsibility Schedule** is first updated and 15th October 2004. In Scotland or **Offshore**, from a date to be agreed between **NGET** and the **Relevant Transmission Licensee**.

ECC.A 1.1.12 Without prejudice to the provisions of ECC.A.1.1.15 which deals with urgent changes, when a **User** identified on a **Site Responsibility Schedule** becomes aware that an alteration is necessary, it must inform **NGET** immediately and in any event 8 weeks prior to any change taking effect (or as soon as possible after becoming aware of it, if less than 8 weeks remain when the **User** becomes aware of the change). This will cover the commissioning of new **Plant** and/or **Apparatus** at the **Connection Site**, whether requiring a revised **Bilateral Agreement** or not, de-commissioning of **Plant** and/or **Apparatus**, and other changes which affect the accuracy of the **Site Responsibility Schedule**.

ECC.A 1.1.13 Where **NGET** has been informed of a change by a **User**, or itself proposes a change, it will prepare a revised **Site Responsibility Schedule** by not less than six weeks prior to the change taking effect (subject to it having been informed or knowing of the change eight weeks prior to that time) and the procedure set out in ECC.A.1.1.8 shall be followed with regard to the revised **Site Responsibility Schedule**.

ECC.A 1.1.14 The revised **Site Responsibility Schedule** shall then be signed in accordance with the procedure set out in ECC.A.1.1.9 and distributed in accordance with the procedure set out in ECC.A.1.1.10, accompanied by a note indicating where the alteration(s) has/have been made, the new issue number and the date of implementation.

Urgent Changes

ECC.A.1.1.15 When a **User** identified on a **Site Responsibility Schedule**, or **NGET**, as the case may be, becomes aware that an alteration to the **Site Responsibility Schedule** is necessary urgently to reflect, for example, an emergency situation which has arisen outside its control, the **User** shall notify **NGET**, or **NGET** shall notify the **User**, as the case may be, immediately and will discuss:

- (a) what change is necessary to the **Site Responsibility Schedule**;
- (b) whether the **Site Responsibility Schedule** is to be modified temporarily or permanently;
- (c) the distribution of the revised **Site Responsibility Schedule**.

NGET will prepare a revised **Site Responsibility Schedule** as soon as possible, and in any event within seven days of it being informed of or knowing the necessary alteration. The **Site Responsibility Schedule** will be confirmed by **Users** and signed on behalf of **NGET** and **Users** (by the persons referred to in ECC.A.1.1.9) as soon as possible after it has been prepared and sent to **Users** for confirmation.

Responsible Managers

ECC.A.1.1.16 Each **User** shall, prior to the **Completion Date** under each **Bilateral Agreement** and/or **Construction Agreement**, supply to **NGET** a list of Managers who have been duly authorised to sign **Site Responsibility Schedules** on behalf of the **User** and **NGET** shall, prior to the **Completion Date** under each **Bilateral Agreement** and/or **Construction Agreement**, supply to that **User** the name of its **Responsible Manager** and for **Connection Sites** in Scotland or **Offshore**, the name of the **Relevant Transmission Licensee's Responsible Manager** and each shall supply to the other any changes to such list six weeks before the change takes effect where the change is anticipated, and as soon as possible after the change, where the change was not anticipated.

De-commissioning of Connection Sites

ECC.A.1.1.17 Where a **Connection Site** is to be de-commissioned, whichever of **NGET** or the **User** who is initiating the de-commissioning must contact the other to arrange for the **Site Responsibility Schedule** to be amended at the relevant time.

PROFORMA FOR SITE RESPONSIBILITY SCHEDULE

AREA _____

COMPLEX: _____

SCHEDULE: _____

CONNECTION SITE: _____

ITEM OF PLANT/ APPARATUS	PLANT APPARATUS OWNER	SITE MANAGER	SAFETY		OPERATIONS		PARTY RESPONSIBLE FOR UNDERTAKING STATUTORY INSPECTIONS, FAULT INVESTIGATION & MAINTENANCE	REMARKS
			SAFETY RULES	CONTROL OR OTHER RESPONSIBLE PERSON (SAFETY CO-ORDINATOR)	OPERATIONAL PROCEDURES	CONTROL OR OTHER RESPONSIBLE ENGINEER		

--	--	--	--	--	--	--	--	--

PAGE: _____ ISSUE NO: _____ DATE: _____

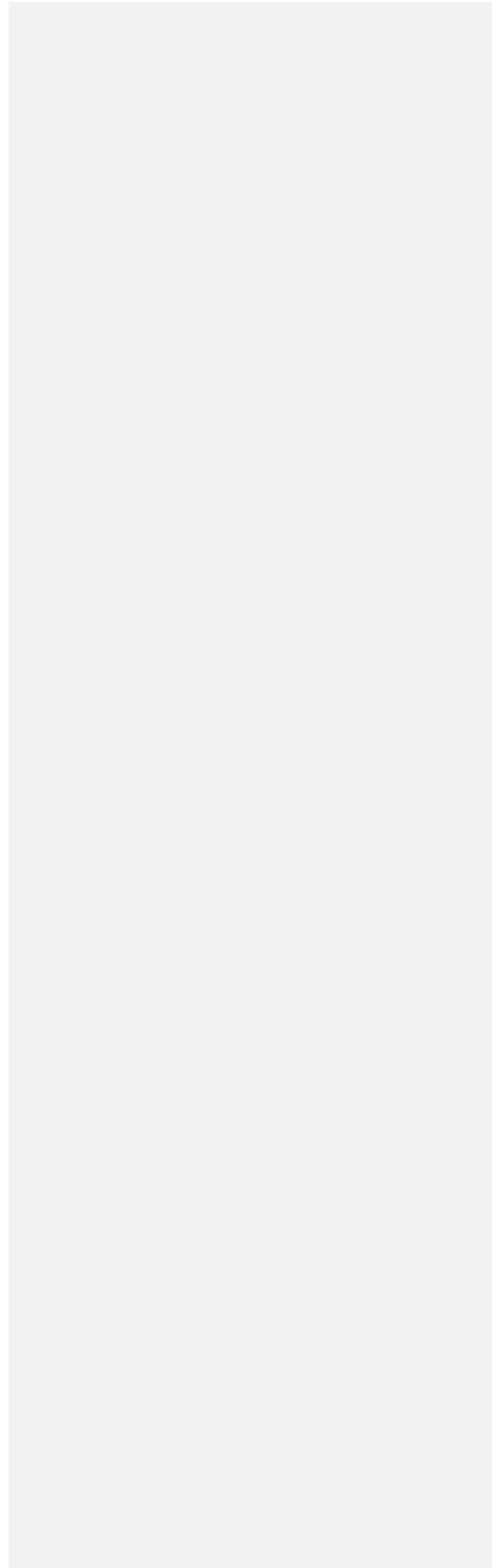

PROFORMA FOR SITE RESPONSIBILITY SCHEDULE

AREA _____

COMPLEX: _____

SCHEDULE: _____

CONNECTION SITE: _____

ITEM OF PLANT/ APPARATUS	PLANT APPARATUS OWNER	SITE MANAGER	SAFETY		OPERATIONS		PARTY RESPONSIBLE FOR UNDERTAKING STATUTORY INSPECTIONS, FAULT INVESTIGATION & MAINTENANCE	REMARKS
			SAFETY RULES	CONTROL OR OTHER RESPONSIBLE PERSON (SAFETY CO-ORDINATOR)	OPERATIONAL PROCEDURES	CONTROL OR OTHER RESPONSIBLE ENGINEER		

NOTES:

SIGNE D: _____ NAM E: _____ COMPAN Y: _____ DATE : _____

SIGNE D: _____ NAM E: _____ COMPAN Y: _____ DATE : _____

SIGNE D: _____ NAM E: _____ COMPAN Y: _____ DATE : _____

SIGNE D: _____ NAM E: _____ COMPAN Y: _____ DATE : _____

PAGE: _____ ISSUE NO: _____ DATE: _____

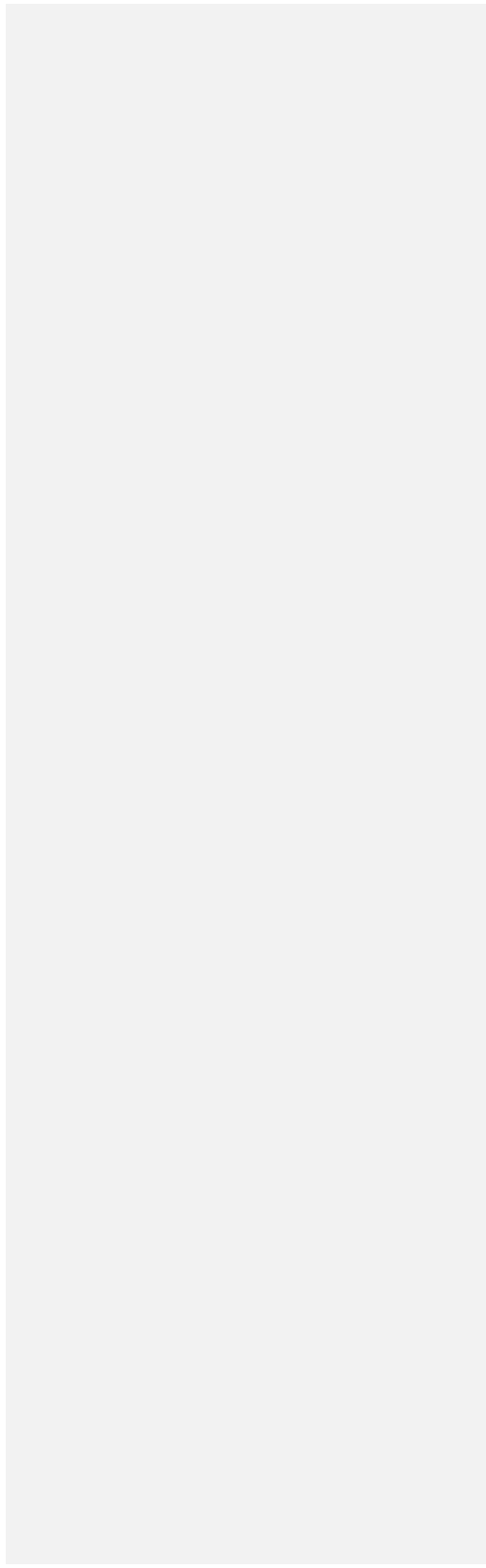

**SP TRANSMISSION Ltd
SITE RESPONSIBILITY SCHEDULE
OWNERSHIP, MAINTENANCE AND OPERATIONS OF EQUIPMENT
IN JOINT USER SITUATIONS**

Sheet No. _____
Revision: _____
Date: _____

Network Area: _____

SECTION 'A' BUILDING AND SITE		SECTION 'B' CUSTOMER OR OTHER PARTY	
OWNER	ACCESS REQUIRED:-	NAME:-	
LESSEE	SPECIAL CONDITIONS:-	ADDRESS:-	
MAINTENANCE		TEL NO:-	
SAFETY	LOCATION OF SUPPLY	SUB STATION:-	
SECURITY	TERMINALS:-	LOCATION:-	

ITEM Nos.	EQUIPMENT	IDENTIFICATION	OWNER	SAFETY RULES APPLICABLE	OPERATION			MAINTENANCE			FAULT INVESTIGATION			TESTING		RELAY SETTINGS	REMARKS
					Tripping	Clearing	Isolating	E arthing	Primary Equip.	Secondary Equip.	Equip.	Primary Equip.	Secondary Equip.	Equip.	Equip.		

SECTION 'D' CONFIGURATION AND CONTROL		SECTION 'E' ADDITIONAL INFORMATION	
ITEM No.	CONFIGURATION RESPONSIBILITY	TELEPHONE NUMBER	REMARKS
ITEM No.	CONTROL RESPONSIBILITY	TELEPHONE NUMBER	REMARKS

AUTHORITATORS:
 D - SP AUTHORISED PERSON - DISTRIBUTION SYSTEM
 NDC - NATIONAL GRID COMPANY
 SPD - SP DISTRIBUTION LTD
 SPPS - POWERSYSTEMS
 SPT - SP TRANSMISSION LTD
 ST - SCOTTISH POWER TELECOMMUNICATIONS
 T - SP AUTHORISED PERSON - TRANSMISSION SYSTEM
 U - USER

SIGNED _____ FOR SP Transmission DATE _____
 SIGNED _____ FOR SP Distribution DATE _____
 SIGNED _____ FOR PowerSystems/User DATE _____

Scottish Hydro-Electric Transmission Limited
Site Responsibility Schedule







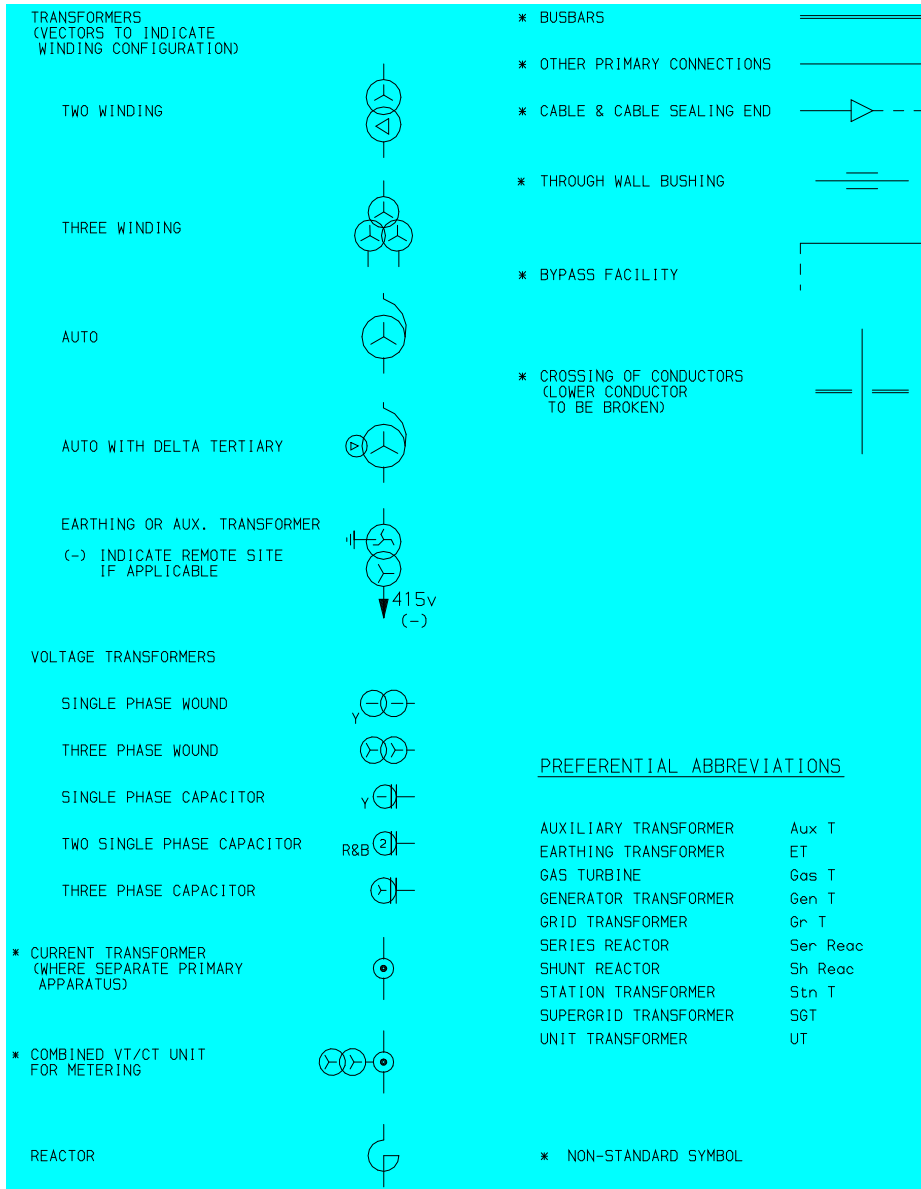

Substation Type	Number:		Revision:						
	Owner	Controller	Maintainer	Responsible System User	Responsible Management Unit	Control Authority	Safety Rules	Operational Procedures	Notes

APPENDIX E2 - OPERATION DIAGRAMS

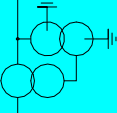

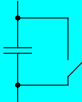

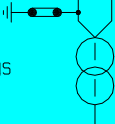





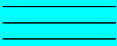
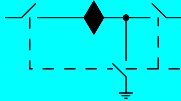

PART 1A - PROCEDURES RELATING TO OPERATION DIAGRAMS

FIXED CAPACITOR		SWITCH DISCONNECTOR	
EARTH		SWITCH DISCONNECTOR WITH INCORPORATED EARTH SWITCH	
EARTHING RESISTOR		DISCONNECTOR (CENTRE ROTATING POST)	
LIQUID EARTHING RESISTOR		DISCONNECTOR (SINGLE BREAK DOUBLE ROTATING)	
ARC SUPPRESSION COIL		DISCONNECTOR (SINGLE BREAK)	
FIXED MAINTENANCE EARTHING DEVICE		DISCONNECTOR (NON-INTERLOCKED)	
CARRIER COUPLING EQUIPMENT (WITHOUT VT)		DISCONNECTOR (POWER OPERATED)	
CARRIER COUPLING EQUIPMENT (WITH VT ON ONE PHASE)		DISCONNECTOR (NON-AUTOMATIC)	
CARRIER COUPLING EQUIPMENT (WITH VT ON 3 PHASES)		DISCONNECTOR (AUTOMATIC)	
AC GENERATOR		DISCONNECTOR (SEQUENTIAL OPERATION)	
SYNCHRONOUS COMPENSATOR		EARTH SWITCH	
CIRCUIT BREAKER		FAULT THROWING SWITCH (PHASE TO PHASE)	
CIRCUIT BREAKER WITH DELAYED AUTO RECLOSE		FAULT THROWING SWITCH (EARTH FAULT)	
WITHDRAWABLE METALCLAD SWITCHGEAR		SURGE ARRESTOR	
		THYRISTOR	

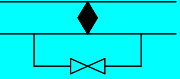

PORTABLE MAINTENANCE EARTH DEVICE		DISCONNECTOR (PANTOGRAPH TYPE)	
QUADRATURE BOOSTER		DISCONNECTOR (KNEE TYPE)	
SHORTING/DISCHARGE SWITCH			
CAPACITOR (INCLUDING HARMONIC FILTER)			
SINGLE PHASE TRANSFORMER (BR) NEUTRAL AND PHASE CONNECTIONS			
RESISTOR WITH INHERENT NON-LINEAR VARIABILITY, VOLTAGE DEPENDANT			

PART E1B - PROCEDURES RELATING TO GAS ZONE DIAGRAMS

GAS INSULATED BUSBAR		DOUBLE-BREAK DISCONNECTOR	
GAS BOUNDARY		EXTERNAL MOUNTED CURRENT TRANSFORMER (WHERE SEPARATE PRIMARY APPARATUS)	
GAS/GAS BOUNDARY		STOP VALVE NORMALLY CLOSED	
GAS/CABLE BOUNDARY		STOP VALVE NORMALLY OPEN	
GAS/AIR BOUNDARY		GAS MONITOR	
GAS/TRANSFORMER BOUNDARY		FILTER	
MAINTENANCE VALVE		QUICK ACTING COUPLING	

**PART E2 - NON-EXHAUSTIVE LIST OF APPARATUS
TO BE INCLUDED ON OPERATION DIAGRAMS**

Basic Principles

- (1) Where practicable, all the **HV Apparatus** on any **Connection Site** shall be shown on one **Operation Diagram**. Provided the clarity of the diagram is not impaired, the layout shall represent as closely as possible the geographical arrangement on the **Connection Site**.
- (2) Where more than one **Operation Diagram** is unavoidable, duplication of identical information on more than one **Operation Diagram** must be avoided.
- (3) The **Operation Diagram** must show accurately the current status of the **Apparatus** e.g. whether commissioned or decommissioned. Where decommissioned, the associated switchbay will be labelled "spare bay".
- (4) Provision will be made on the **Operation Diagram** for signifying approvals, together with provision for details of revisions and dates.
- (5) **Operation Diagrams** will be prepared in A4 format or such other format as may be agreed with **NGET**.
- (6) The **Operation Diagram** should normally be drawn single line. However, where appropriate, detail which applies to individual phases shall be shown. For example, some **HV Apparatus** is numbered individually per phase.

Apparatus To Be Shown On Operation Diagram

- (1) Busbars
- (2) Circuit Breakers
- (3) Disconnecter (Isolator) and Switch Disconnecters (Switching Isolators)
- (4) Disconnectors (Isolators) - Automatic Facilities
- (5) Bypass Facilities
- (6) Earthing Switches
- (7) Maintenance Earths
- (8) Overhead Line Entries
- (9) Overhead Line Traps
- (10) Cable and Cable Sealing Ends
- (11) Generating Unit
- (12) Generator Transformers
- (13) Generating Unit Transformers, Station Transformers, including the lower voltage circuit-breakers.
- (14) Synchronous Compensators
- (15) Static Variable Compensators
- (16) Capacitors (including Harmonic Filters)
- (17) Series or Shunt Reactors (Referred to as "Inductors" at nuclear power station sites)

- (18) Supergrid and Grid Transformers
- (19) Tertiary Windings
- (20) Earthing and Auxiliary Transformers
- (21) Three Phase VT's
- (22) Single Phase VT & Phase Identity
- (23) High Accuracy VT and Phase Identity
- (24) Surge Arrestors/Diverters
- (25) Neutral Earthing Arrangements on HV Plant
- (26) Fault Throwing Devices
- (27) Quadrature Boosters
- (28) Arc Suppression Coils
- (29) Single Phase Transformers (BR) Neutral and Phase Connections
- (30) Current Transformers (where separate plant items)
- (31) Wall Bushings
- (32) Combined VT/CT Units
- (33) Shorting and Discharge Switches
- (34) Thyristor
- (35) Resistor with Inherent Non-Linear Variability, Voltage Dependent
- (36) Gas Zone

APPENDIX E3 - MINIMUM FREQUENCY RESPONSE CAPABILITY REQUIREMENT PROFILE AND OPERATING RANGE FOR POWER GENERATING MODULES AND HVDC EQUIPMENT

ECC.A.3.1 Scope

The frequency response capability is defined in terms of **Primary Response**, **Secondary Response** and **High Frequency Response**. In addition to the requirements defined in ECC.6.3.7 this appendix defines the minimum frequency response requirements for:-

- (a) each **Type C** and **Type D Power Generating Module**
- (b) each **DC Connected Power Park Module**
- (c) each **HVDC System**

For the avoidance of doubt, this appendix does not apply to **Type A** and **Type B Power Generating Modules**.

OTSDUW Plant and Apparatus should facilitate the delivery of frequency response services provided by **Offshore Generating Units** and **Offshore Power Park Units**.

The functional definition provides appropriate performance criteria relating to the provision of **Frequency** control by means of **Frequency** sensitive generation in addition to the other requirements identified in ECC.6.3.7.

In this Appendix 3 to the ECC, for a **Power Generating Module** including a **CCGT Module** or a **Power Park Module** or **DC Connected Power Park Module**, the phrase **Minimum Regulating Level** applies to the entire **CCGT Module** or **Power Park Module** or **DC Connected Power Park Module** operating with all **Generating Units Synchronised** to the **System**.

The minimum **Frequency** response requirement profile is shown diagrammatically in Figure ECC.A.3.1. The capability profile specifies the minimum required level of **Frequency Response Capability** throughout the normal plant operating range.

ECC.A.3.2 Plant Operating Range

The upper limit of the operating range is the **Maximum Capacity** of the **Power Generating Module** or **Generating Unit** or **CCGT Module** or **HVDC Equipment**.

The **Minimum Stable Operating Level** may be less than, but must not be more than, 65% of the **Maximum Capacity**. Each **Power Generating Module** and/or **Generating Unit** and/or **CCGT Module** and/or **Power Park Module** or **HVDC Equipment** must be capable of operating satisfactorily down to the **Minimum Regulating Level** as dictated by **System** operating conditions, although it will not be instructed to below its **Minimum Stable Operating Level**. If a **Power Generating Module** or **Generating Unit** or **CCGT Module** or **Power Park Module**, or **HVDC Equipment** is operating below **Minimum Stable Operating Level** because of high **System Frequency**, it should recover adequately to its **Minimum Stable Operating Level** as the **System Frequency** returns to **Target Frequency** so that it can provide **Primary** and **Secondary Response** from its **Minimum Stable Operating Level** if the **System Frequency** continues to fall. For the avoidance of doubt, under normal operating conditions steady state operation below the **Minimum Stable Operating Level** is not expected. The **Minimum Regulating Level** must not be more than 55% of **Maximum Capacity**.

In the event of a **Power Generating Module** or **Generating Unit** or **CCGT Module** or **Power Park Module** or **HVDC Equipment** load rejecting down to no less than its **Minimum Regulating Level** it should not trip as a result of automatic action as detailed in BC3.7. If the load rejection is to a level less than the **Minimum Regulating Level** then it is accepted that the condition might be so severe as to cause it to be disconnected from the **System**.

ECC.A.3.3 Minimum Frequency Response Requirement Profile

Figure ECC.A.3.1 shows the minimum **Frequency** response capability requirement profile diagrammatically for a 0.5 Hz change in **Frequency**. The percentage response capabilities and loading levels are defined on the basis of the **Maximum Capacity** of the **Power Generating Module** or **CCGT Module** or **Power Park Module** or **HVDC Equipment**. Each **Power Generating Module** or and/or **CCGT Module** or **Power Park Module** (including a **DC Connected Power Park Module**) and/or **HVDC Equipment** must be capable of operating in a manner to provide **Frequency** response at least to the solid boundaries shown in the figure. If the **Frequency** response capability falls within the solid boundaries, the **Power Generating Module** or **CCGT Module** or **Power Park Module** or **HVDC Equipment** is providing response below the minimum requirement which is not acceptable. Nothing in this appendix is intended to prevent a **Power Generating Module** or **CCGT Module** or **Power Park Module** or **HVDC Equipment** from being designed to deliver a **Frequency** response in excess of the identified minimum requirement.

The **Frequency** response delivered for **Frequency** deviations of less than 0.5 Hz should be no less than a figure which is directly proportional to the minimum **Frequency** response requirement for a **Frequency** deviation of 0.5 Hz. For example, if the **Frequency** deviation is 0.2 Hz, the corresponding minimum **Frequency** response requirement is 40% of the level shown in Figure ECC.A.3.1. The **Frequency** response delivered for **Frequency** deviations of more than 0.5 Hz should be no less than the response delivered for a **Frequency** deviation of 0.5 Hz.

Each **Power Generating Module** and/or **CCGT Module** and/or **Power Park Module** or **HVDC Equipment** must be capable of providing some response, in keeping with its specific operational characteristics, when operating between 95% to 100% of **Maximum Capacity** as illustrated by the dotted lines in Figure ECC.A.3.1.

At the **Minimum Stable Operating** level, each **Power Generating Module** and/or **CCGT Module** and/or **Power Park Module** and/or **HVDC Equipment** is required to provide high and low frequency response depending on the **System Frequency** conditions. Where the **Frequency** is high, the **Active Power** output is therefore expected to fall below the **Minimum Stable Operating** level.

The **Minimum Regulating Level** is the output at which a **Power Generating Module** and/or **CCGT Module** and/or **Power Park Module** and/or **HVDC Equipment** has no **High Frequency Response** capability. It may be less than, but must not be more than, 55% of the **Maximum Capacity**. This implies that a **Power Generating Module** or **CCGT Module** or **Power Park Module** or **HVDC Equipment** is not obliged to reduce its output to below this level unless the **Frequency** is at or above 50.5 Hz (cf BC3.7).

ECC.A.3.4 Testing of Frequency Response Capability

The frequency response capabilities shown diagrammatically in Figure ECC.A.3.1 are measured by taking the responses as obtained from some of the dynamic step response tests specified by NGET and carried out by **Generators** and **HVDC System** owners for compliance purposes. The injected signal is a step of 0.5Hz from zero to 0.5 Hz **Frequency** change, and is sustained at 0.5 Hz **Frequency** change thereafter, the latter as illustrated diagrammatically in figures ECC.A.3.4 and ECC.A.3.5.

In addition to provide and/or to validate the content of **Ancillary Services Agreements** a progressive injection of a **Frequency** change to the plant control system (i.e. governor and load controller) is used. The injected signal is a ramp of 0.5Hz from zero to 0.5 Hz **Frequency** change over a ten second period, and is sustained at 0.5 Hz **Frequency** change thereafter, the latter as illustrated diagrammatically in figures ECC.A.3.2 and ECC.A.3.3. In the case of an **Embedded Medium Power Station** not subject to a **Bilateral Agreement** or **Embedded HVDC System** not subject to a **Bilateral Agreement**, NGET may require the **Network Operator** within whose System the **Embedded Medium Power Station** or **Embedded HVDC System** is situated, to ensure that the **Embedded Person** performs the dynamic response tests reasonably required by NGET in order to demonstrate compliance within the relevant requirements in the ECC.

The **Primary Response** capability (P) of a **Power Generating Module** or a **CCGT Module** or **Power Park Module** or **HVDC Equipment** is the minimum increase in **Active Power** output between 10 and 30 seconds after the start of the ramp injection as illustrated diagrammatically in Figure ECC.A.3.2. This increase in **Active Power** output should be released increasingly with time over the period 0 to 10 seconds from the time of the start of the **Frequency** fall as illustrated by the response from Figure ECC.A.3.2.

The **Secondary Response** capability (S) of a **Power Generating Module** or a **CCGT Module** or **Power Park Module** or **HVDC Equipment** is the minimum increase in **Active Power** output between 30 seconds and 30 minutes after the start of the ramp injection as illustrated diagrammatically in Figure ECC.A.3.2.

The **High Frequency Response** capability (H) of a **Power Generating Module** or a **CCGT Module** or **Power Park Module** or **HVDC Equipment** is the decrease in **Active Power** output provided 10 seconds after the start of the ramp injection and sustained thereafter as illustrated diagrammatically in Figure ECC.A.3.3. This reduction in **Active Power** output should be released increasingly with time over the period 0 to 10 seconds from the time of the start of the **Frequency** rise as illustrated by the response in Figure ECC.A.3.2.

ECC.A.3.5 **Repeatability Of Response**

When a **Power Generating Module** or **CCGT Module** or **Power Park Module** or **HVDC Equipment** has responded to a significant **Frequency** disturbance, its response capability must be fully restored as soon as technically possible. Full response capability should be restored no later than 20 minutes after the initial change of **System Frequency** arising from the **Frequency** disturbance.

Figure ECC.A.3.1 - Minimum Frequency Response requirement profile for a 0.5 Hz frequency change from Target Frequency

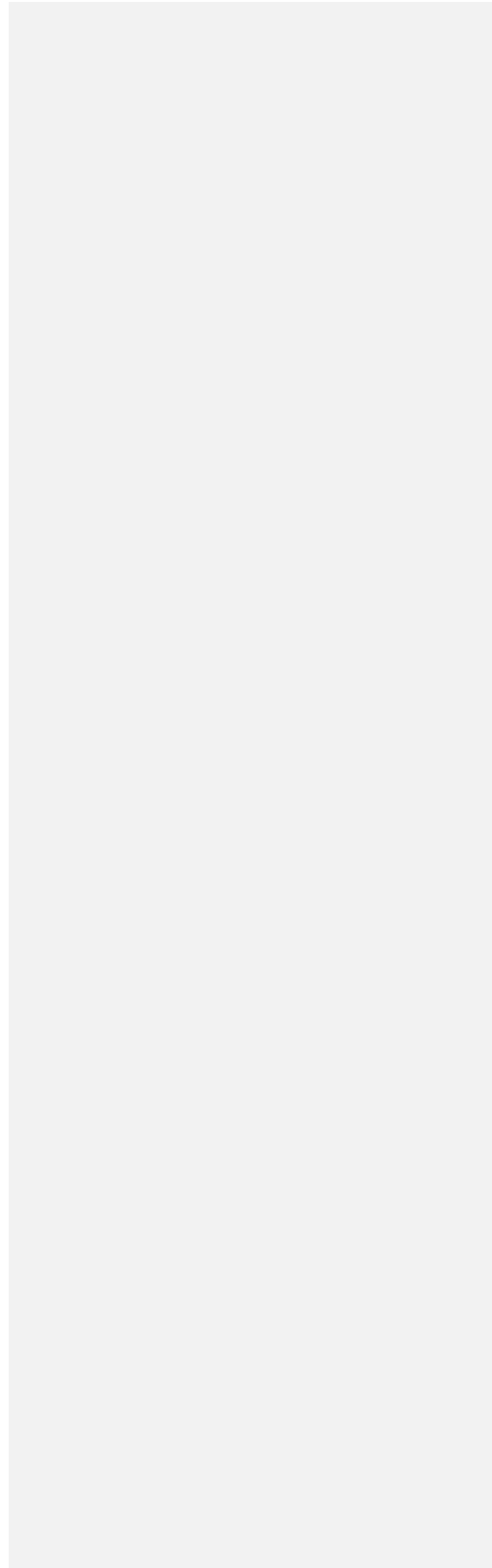

Figure ECC.A.3.1 – Minimum Frequency Response Capability Requirement Profile for a 0.5Hz change from Target Frequency

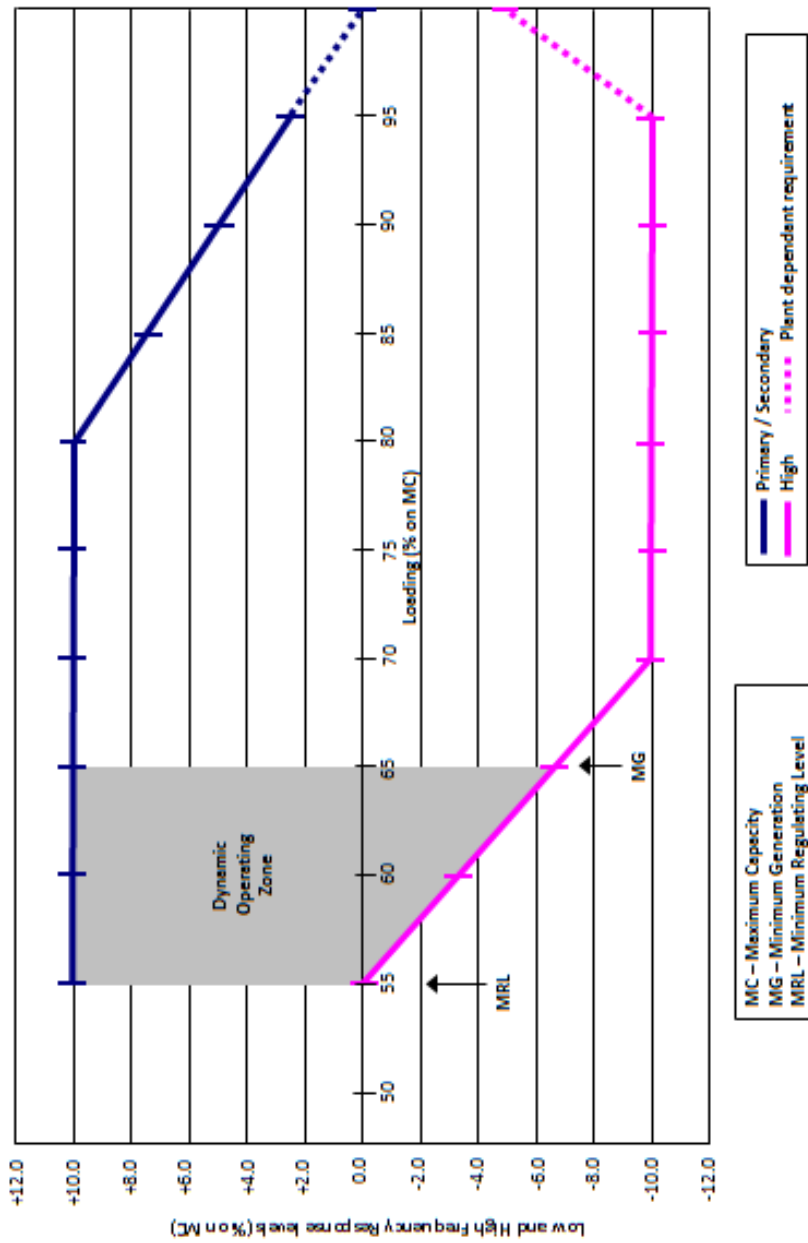

Figure ECC.A.3.2 – Interpretation of Primary and Secondary Response Service Values

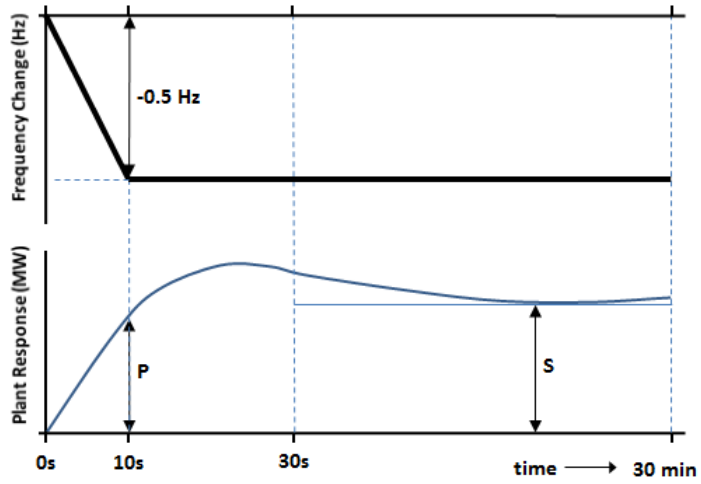

Figure ECC.A.3.3 – Interpretation of High Frequency Response Service Values

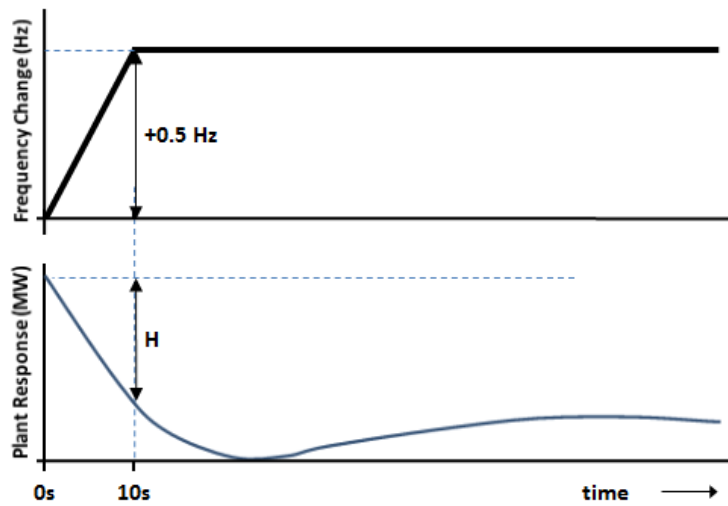

Figure ECC.A.3.4 – Interpretation of Low Frequency Response Capability Values

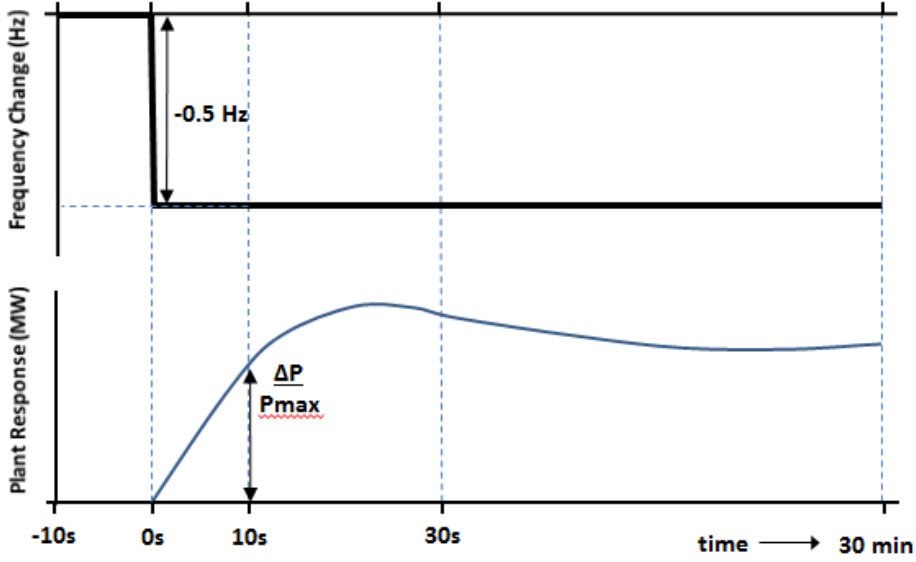
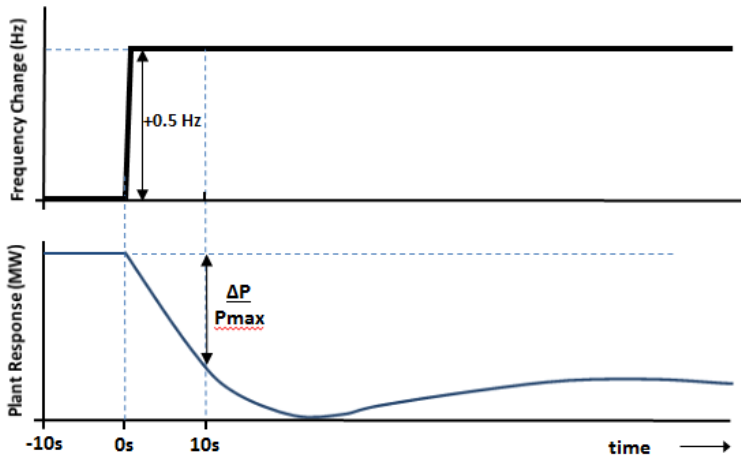

Figure ECC.A.3.5 – Interpretation of High Frequency Response Capability Values



ECC.4 - APPENDIX 4 - FAULT RIDE THROUGH REQUIREMENTS

FAULT RIDE THROUGH REQUIREMENTS FOR TYPE B, TYPE C AND TYPE D POWER GENERATING MODULES (INCLUDING OFFSHORE POWER PARK MODULES WHICH ARE EITHER AC CONNECTED POWER PARK MODULES OR DC CONNECTED POWER PARK MODULES), HVDC SYSTEMS AND OTSDUW PLANT AND APPARATUS

ECC.A.4A.1 Scope

The **Fault Ride Through** requirements are defined in ECC.6.3.15. This Appendix provides illustrations by way of examples only of ECC.6.3.15.1 to ECC.6.3.15.10 and further background and illustrations and is not intended to show all possible permutations.

ECC.A.4A.2 Short Circuit Faults At Supergrid Voltage On The Onshore Transmission System Up To 140ms In Duration

For short circuit faults at **Supergrid Voltage** on the **Onshore Transmission System** (which could be at an **Interface Point**) up to 140ms in duration, the **Fault Ride Through** requirement is defined in ECC.6.3.15. In summary any **Power Generating Module** (including a **DC Connected Power Park Module**) or **HVDC System** is required to remain connected and stable whilst connected to a healthy circuit. Figure ECC.A.4.A.2 illustrates this principle.

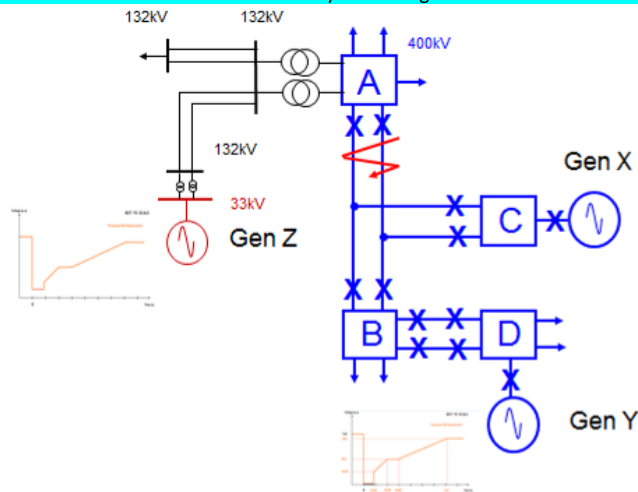

Figure ECC.A.4.A.2

In Figure ECC.A.4.A.2 a solid three phase short circuit fault is applied adjacent to substation A resulting in zero voltage at the point of fault. All circuit breakers on the faulty circuit (Lines ABC) will open within 140ms resulting in Gen X tripping. The effect of this fault, due to the low impedance of the network, will be the observation of a low voltage at each substation node across the **Total System** until the fault has been cleared. In this example, Gen Y and Gen Z (an Embedded Generator) would need to remain connected and stable as both are still connected to the **Total System** and remain connected to healthy circuits.

The criteria for assessment is based on a voltage against time curve at each **Grid Entry Point** or **User System Entry Point**. The voltage against time curve at the **Grid Entry Point** or **User System Entry Point** varies for each different type and size of **Power Generating Module** as detailed in ECC.6.3.15.2. – ECC.6.3.15.7.

The voltage against time curve represents the voltage profile at a **Grid Entry Point** or **User System Entry Point** that would be obtained by plotting the voltage at that **Grid Entry Point** or **User System Entry Point** before during and after the fault. This is not to be confused with a voltage duration curve (as defined under ECC.6.3.15.9) which represents a voltage level and associated time duration.

The post fault voltage at a **Grid Entry Point** or **User System Entry Point** is largely influenced by the topology of the network rather than the behaviour of the **Power Generating Module** itself. The **EU Generator** therefore needs to ensure each **Power Generating Module** remains connected and stable for a close up solid three phase short circuit fault for 140ms at the **Grid Entry Point** or **User System Entry Point**.

Two examples are shown in Figure EA.4.2(a) and Figure EA4.2(b). In Figure EA.4.2(a) the post fault profile is above the heavy black line. In this case the **Power Generating Module** must remain connected and stable. In Figure EA4.2(b) the post fault voltage dips below the heavy black line in which case the **Power Generating Module** is permitted to trip.

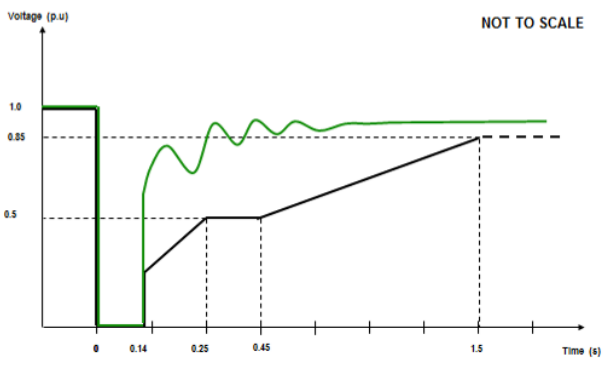

Figure EA.4.2(a)

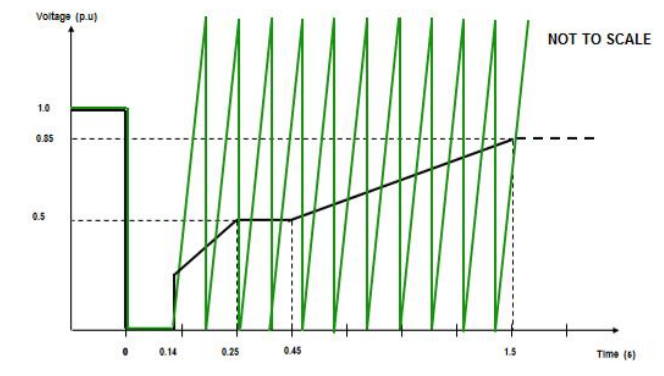

Figure EA.4.2(b)

The process for demonstrating **Fault Ride Through** compliance against the requirements of ECC.6.3.15 is detailed in ECP.A.3.5 and ECP.A.6.7 (as applicable).

ECC.A.4A.3 Supergrid Voltage Dips On The Onshore Transmission System Greater Than 140ms In Duration

ECC.A.4A3.1 Requirements applicable to **Synchronous Power Generating Modules** subject to **Supergrid Voltage** dips on the **Onshore Transmission System** greater than 140ms in duration.

For balanced **Supergrid Voltage** dips on the **Onshore Transmission System** having durations greater than 140ms and up to 3 minutes, the **Fault Ride Through** requirement is defined in ECC.6.3.15.9.2.1(a) and Figure ECC.6.3.15.9(a) which is reproduced in this Appendix as Figure EA.4.3.1 and termed the voltage–duration profile.

This profile is not a voltage-time response curve that would be obtained by plotting the transient voltage response at a point on the **Onshore Transmission System** (or **User System** if located **Onshore**) to a disturbance. Rather, each point on the profile (ie the heavy black line) represents a voltage level and an associated time duration which connected **Synchronous Power Generating Modules** must withstand or ride through.

Figures EA.4.3.2 (a), (b) and (c) illustrate the meaning of the voltage-duration profile for voltage dips having durations greater than 140ms.

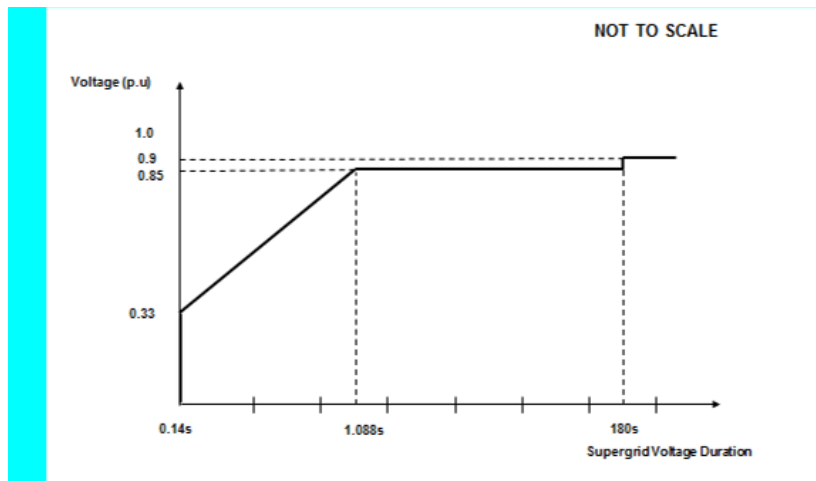

Figure EA.4.3.1

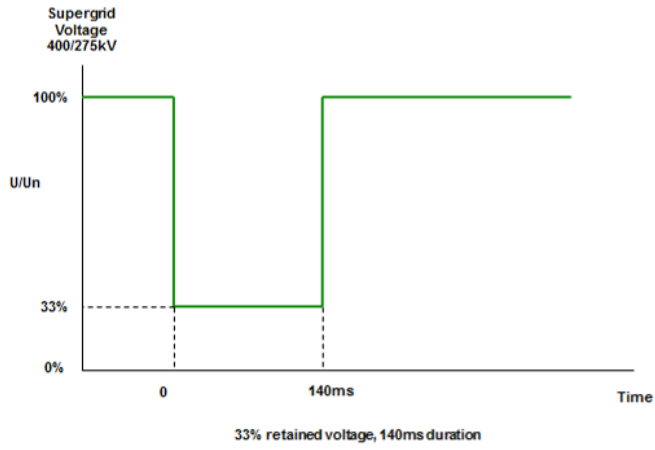

Figure EA.4.3.2 (a)

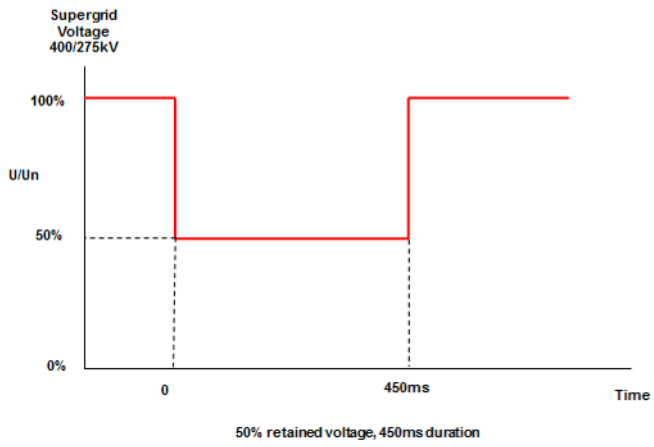

Figure EA.4.3.2 (b)

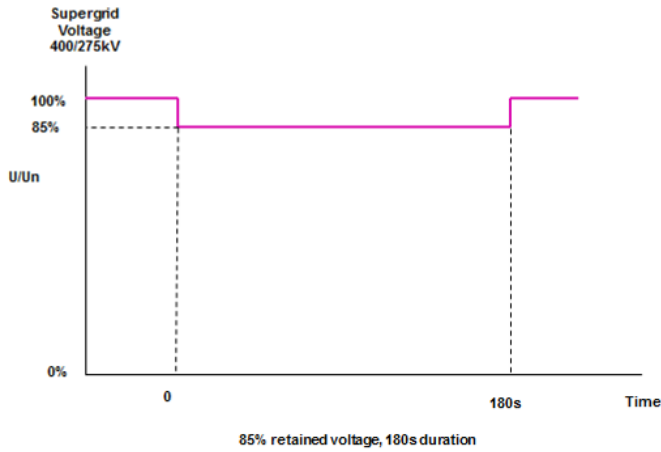

Figure EA.4.3.2 (c)

ECC.A.4A3.2 Requirements applicable to **Power Park Modules or OTSDUW Plant and Apparatus** subject to **Supergrid Voltage** dips on the **Onshore Transmission System** greater than 140ms in duration

For balanced **Supergrid Voltage** dips on the **Onshore Transmission System** (which could be at an **Interface Point**) having durations greater than 140ms and up to 3 minutes the **Fault Ride Through** requirement is defined in ECC.6.3.15.9.2.1(b) and Figure ECC.6.3.15.9(b) which is reproduced in this Appendix as Figure EA.4.3.3 and termed the voltage-duration profile.

This profile is not a voltage-time response curve that would be obtained by plotting the transient voltage response at a point on the **Onshore Transmission System** (or **User System** if located **Onshore**) to a disturbance. Rather, each point on the profile (ie the heavy black line) represents a voltage level and an associated time duration which connected **Power Park Modules or OTSDUW Plant and Apparatus** must withstand or ride through.

Figures EA.4.3.4 (a), (b) and (c) illustrate the meaning of the voltage-duration profile for voltage dips having durations greater than 140ms.



Figure EA.4.3.3

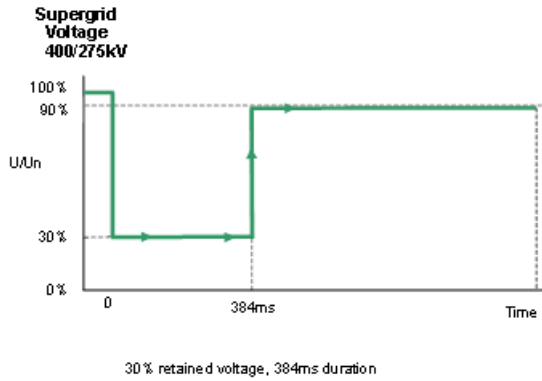

Figure EA.4.3.4(a)

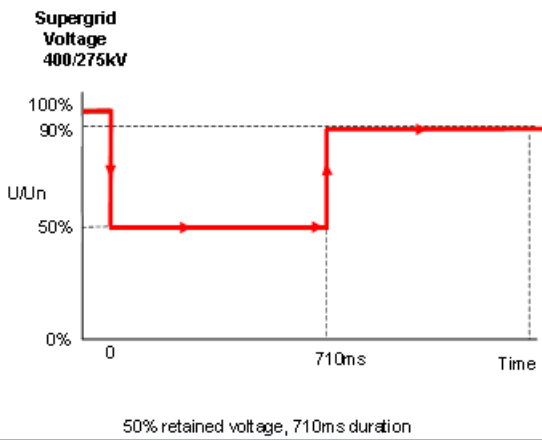

Figure EA.4.3.4 (b)

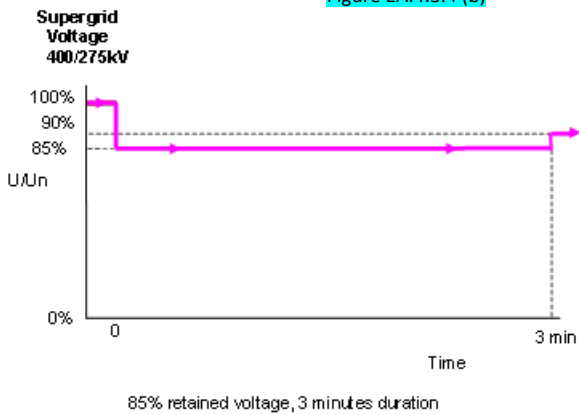

Figure EA.4.3.4 (c)

APPENDIX 4EC – FAST FAULT CURRENT INJECTION REQUIREMENTS

FAST FAULT CURRENT INJECTION REQUIREMENTS FOR POWER PARK MODULES, HVDC SYSTEMS, DC CONNECTED POWER PARK MODULES AND REMOTE END HVDC CONVERTERS

ECC.A.4EC1 Fast Fault Current Injection requirements

ECC.4EC1.1 Fast Fault Current Injection behaviour during a solid three phase close up short circuit fault lasting up to 140ms

ECC.4EC1.1.1 For a voltage depression at a **Grid Entry Point** or **User System Point**, the **Fast Fault Current Injection** requirements are detailed in ECC.6.3.16. Figure ECC4.1 shows an example of a **500MW Power Park Module** subject to a close up solid three phase short circuit fault connected directly connected to the **Transmission System** operating at 400kV.

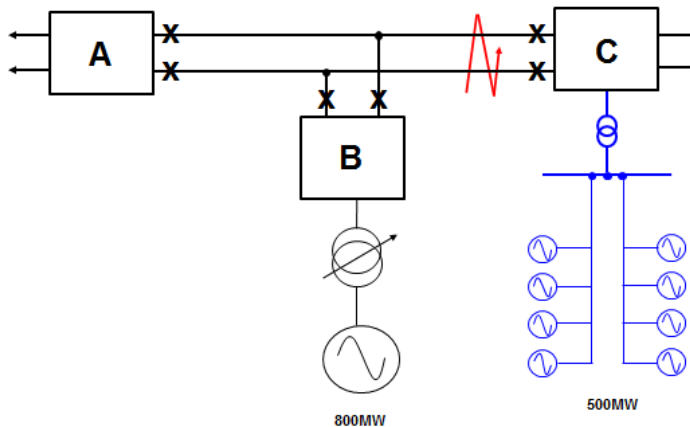

Figure ECC4.1

ECC.4EC1.1.2 Assuming negligible impedance between the fault and substation C, the voltage at Substation C will be close to zero until circuit breakers at Substation C open, typically within 80 – 100ms, subsequently followed by the opening of circuit breakers at substations A and B, typically 140ms after fault inception. The operation of circuit breakers at Substations A, B and C will also result in the tripping of the 800MW generator which is permitted under the SQSS. The **Power Park Module** is required to satisfy the requirements of ECC.6.3.16, and an example of the deviation in system voltage at the **Grid Entry Point** and expected reactive current injected by the **Power Park Module** before and during the fault is shown in Figure ECC4.2(a) and (b).

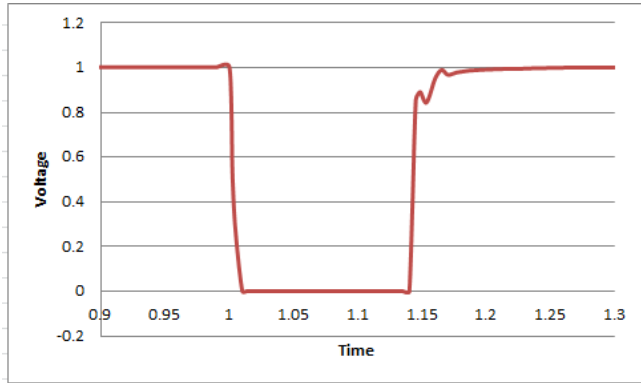

Figure ECC4.2(a) –Voltage deviation at Substation C

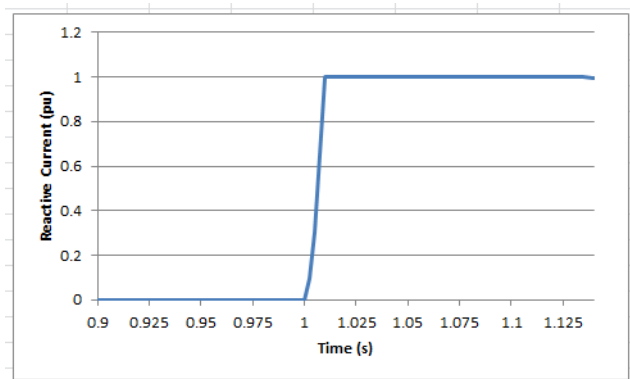

Figure ECC4.2(b) – Reactive Current Injected from the Power Park Module connected to Substation C

It is important to note that blocking is permitted upon fault clearance in order to limit the impact of transient overvoltages. This effect is shown in Figure ECC4.3(a) and Figure ECC4.3(b)

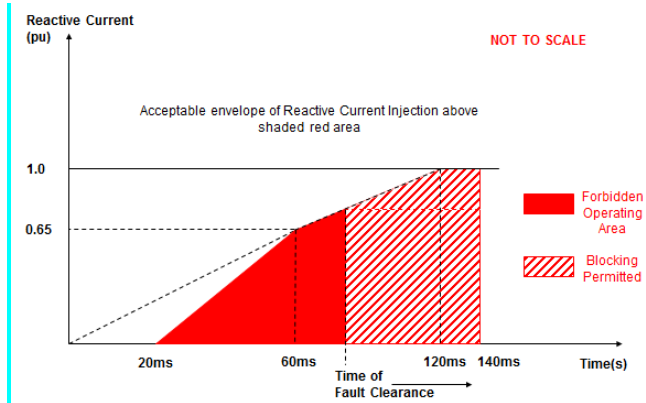

Figure ECC4.3(a)

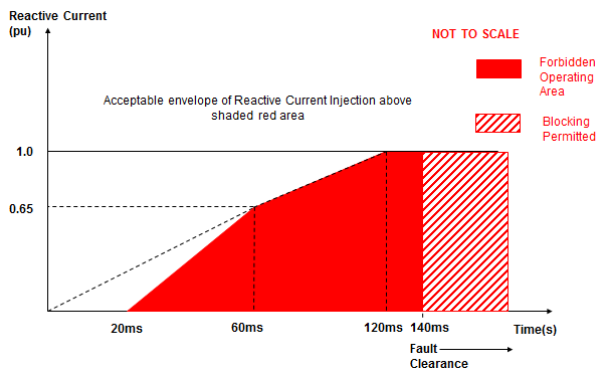

Figure ECC4.3(b)

ECC.4EC1.1.3 So long as the reactive current injected is above the shaded area as illustrated in Figure ECC4.3(a) or ECC4.3(b), the **Power Park Module** would be considered to be compliant with the requirements of ECC.6.3.16 Taking the example outlined in ECC.4EC1.1.1 where the fault is cleared in 140ms, the following diagram in Figure ECC4.4 results.

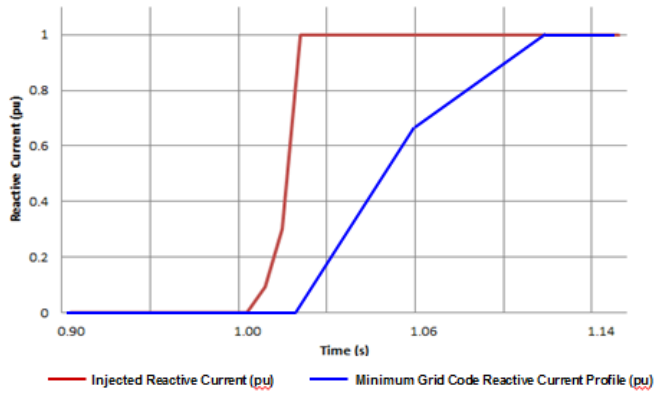

Figure ECC4.4 – Injected Reactive Current from Power Park Module compared to the minimum required Grid Code profile

ECC.4EC1.2 **Fast Fault Current Injection behaviour during a voltage dip at the Connection Point lasting in excess of 140ms**

ECC.4EC1.2.1 Under the fault ride through requirements specified in ECC.6.3.15.9 (*Voltage dips cleared in excess of 140ms*), **Type B, Type C and Type D Power Park Modules** are also required to remain connected and stable for voltage dips on the **Transmission System** in excess of 140ms. Figure ECC4.4 (a) shows an example of a 500MW **Power Park Module** connected to the **Transmission System** and Figure ECC4.4 (b) shows the corresponding voltage dip seen at the **Grid Entry Point** or **User System Point** which has resulted from a remote fault on the **Transmission System** cleared in a backup operating time of 710ms.

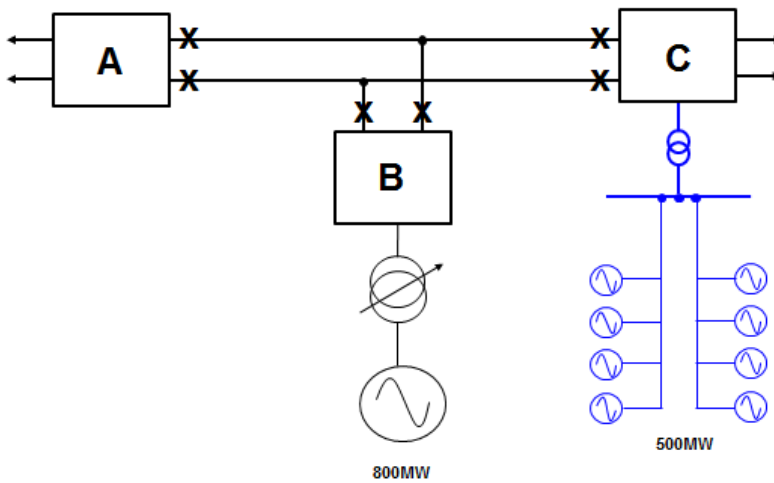

Figure ECC4.4(a)

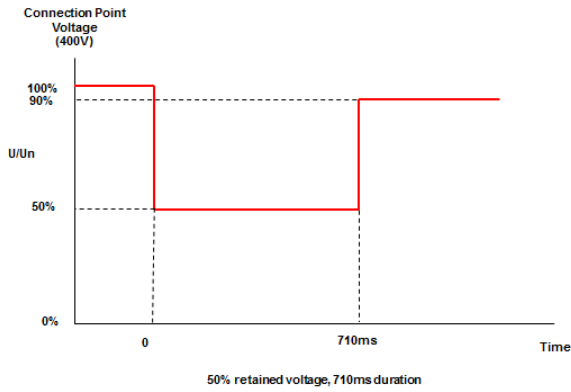

Figure ECC4.4 (b)

ECC.4EC1.2.1 In this example, the voltage dips to 0.5pu for 710ms. Under ECC.6.3.16 each **Type B, Type C and Type D Power Park Module** is required to inject reactive current into the **System** and shall respond in proportion to the change in **System** voltage at the **Grid Entry Point** or **User System Entry Point** up to a maximum value of 1.0pu of rated current. An example of the expected injected reactive current at the **Connection Point** is shown in Figure ECC4.5

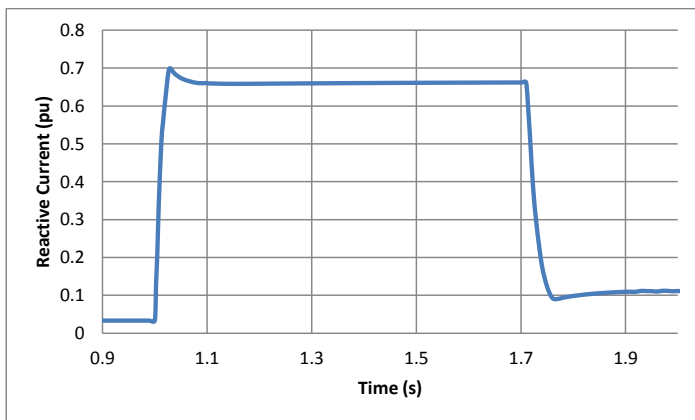

Figure ECC4.5 Reactive Current Injected for a 50% voltage dip for a period of 710ms

APPENDIX E5 - TECHNICAL REQUIREMENTS
LOW FREQUENCY RELAYS FOR THE AUTOMATIC
DISCONNECTION OF SUPPLIES AT LOW FREQUENCY

ECC.A.5.1 Low Frequency Relays

ECC.A.5.1.1 The **Low Frequency Relays** to be used shall have a setting range of 47.0 to 50Hz and be suitable for operation from a nominal AC input of 63.5, 110 or 240V. The following parameters specify the requirements of approved **Low Frequency Relays**:

- (a) **Frequency** settings: 47-50Hz in steps of 0.05Hz or better, preferably 0.01Hz;
- (b) **Operating time**: Relay operating time shall not be more than 150 ms;
- (c) **Voltage lock-out**: Selectable within a range of 55 to 90% of nominal voltage;

(d) **Direction** Tripping interlock for forward or reverse power flow capable of being set in either position or off

(e) **Facility stages**: One or two stages of **Frequency** operation;

(f) **Output contacts**: Two output contacts per stage to be capable of repetitively making and breaking for 1000 operations:

(g) **Accuracy**: 0.01 Hz maximum error under reference environmental and system voltage conditions.
0.05 Hz maximum error at 8% of total harmonic distortion
Electromagnetic Compatibility Level.

(h) **Indications** Provide the direction of Active Power flow at the point of de-energisation.

In the case of **Network Operators's** who are also **GB Code Users's**, the above requirements ~~would~~ only apply to ~~a~~the relay (if any) installed at the **EU Grid Supply Point**. **Network Operators's** who are also **GB Code Users** should continue to satisfy the requirements for low frequency relays as specified in the **CC's** as applicable to their **Total System**.

ECC.A.5.2 Low Frequency Relay Voltage Supplies

ECC.A.5.2.1 It is essential that the voltage supply to the **Low Frequency Relays** shall be derived from the primary **System** at the supply point concerned so that the **Frequency** of the **Low Frequency Relays** input voltage is the same as that of the primary **System**. This requires either:

- (a) the use of a secure supply obtained from voltage transformers directly associated with the grid transformer(s) concerned, the supply being obtained where necessary via a suitable automatic voltage selection scheme; or
- (b) the use of the substation 240V phase-to-neutral selected auxiliary supply, provided that this supply is always derived at the supply point concerned and is never derived from a standby supply **Power Generating Module** or from another part of the **User System**.

ECC.A.5.3 Scheme Requirements

Formatted: Font color: Auto

Formatted: Font color: Auto

Formatted: Font color: Auto

Formatted: Font color: Auto

Formatted: Font color: Auto

Formatted: Font color: Auto

Formatted: Font color: Auto

Formatted: Font color: Auto

Formatted: Font color: Auto

Formatted: Font color: Auto

Formatted: Font color: Auto

Formatted: Font color: Auto

Formatted: List Paragraph, Indent: Left: 0.06 cm, Hanging: 0.5 cm, Numbered + Level: 1 + Numbering Style: a, b, c, ... + Start at: 1 + Alignment: Left + Aligned at: 2.5 cm + Indent at: 3.14 cm

Formatted: Font color: Auto

Formatted: Font color: Auto

Formatted: Font color: Auto

Formatted: Font color: Auto

Formatted: Font color: Auto

Formatted: Font color: Auto

Formatted: Font color: Auto

Formatted: Font color: Auto

Formatted: Font color: Auto

Formatted: Indent: Left: 0 cm

Formatted: Level 3 Text, Indent: Left: 2.5 cm, Tab stops: Not at 3.81 cm + 4.83 cm + 6.1 cm + 8.13 cm + 10.41 cm + 11.68 cm

Formatted: Font: Bold

Formatted: Font: Bold

Formatted: Font: Bold

Formatted: Font: Bold

Formatted: Font: Bold

Formatted: Font: Bold

Formatted: Font: Not Bold

Formatted: Font: Not Bold

Formatted: Font: Calibri, Font color: Auto

Formatted: Font color: Auto

Formatted: Font color: Auto

Formatted: Font color: Auto

ECC.A.5.3.1 The tripping facility should be engineered in accordance with the following reliability considerations:

Formatted: Font color: Auto

(a) Dependability

Failure to trip at any one particular **Demand** shedding point would not harm the overall operation of the scheme. However, many failures would have the effect of reducing the amount of **Demand** under low **Frequency** control. An overall reasonable minimum requirement for the dependability of the **Demand** shedding scheme is 96%, i.e. the average probability of failure of each **Demand** shedding point should be less than 4%. Thus the **Demand** under low **Frequency** control will not be reduced by more than 4% due to relay failure.

(b) Outages

Low Frequency Demand shedding schemes will be engineered such that the amount of **Demand** under control is as specified in Table ECC.A.5.5.1a and is not reduced unacceptably during equipment outage or maintenance conditions.

Formatted: Font color: Auto

ECC.A.5.3.2 The total operating time of the scheme, including circuit breakers operating time, shall where reasonably practicable, be less than 200 ms. For the avoidance of doubt, the replacement of plant installed prior to October 2009 will not be required in order to achieve lower total scheme operating times.

Formatted: Font color: Auto

ECC.A.5.4 Low Frequency Relay Testing

Formatted: Font color: Auto

ECC.A.5.4.1 **Low Frequency Relays** installed and commissioned after 1st January 2007 shall be type tested in accordance with and comply with the functional test requirements for **Frequency Protection** contained in Energy Networks Association Technical Specification 48-6-5 Issue 1 dated 2005 “**ENA Protection Assessment Functional Test Requirements – Voltage and Frequency Protection**”.

Formatted: Font color: Auto

For the avoidance of doubt, **Low Frequency Relays** installed and commissioned before 1st January 2007 shall comply with the version of ECC.A.5.1.1 applicable at the time such **Low Frequency Relays** were commissioned.

Formatted: Font color: Auto

ECC.A.5.5 Scheme Settings

Formatted: Font color: Auto

ECC.A.5.5.1 Table CC.A.5.5.1a shows, for each **Transmission Area**, the percentage of **Demand** (based on **Annual ACS Conditions**) at the time of forecast **National Electricity Transmission System** peak **Demand** that each **Network Operator** whose **System** is connected to the **Onshore Transmission System** within such **Transmission Area** shall disconnect by **Low Frequency Relays** at a range of frequencies. Where a **Network Operator’s System** is connected to the **National Electricity Transmission System** in more than one **Transmission Area**, the settings for the **Transmission Area** in which the majority of the **Demand** is connected shall apply.

Formatted: Underline, Font color: Auto

Formatted: Font color: Auto

Frequency Hz	% Demand disconnection for each Network Operator in Transmission Area		
	NGET	SPT	SHETL
48.8	5		
48.75	5		
48.7	10		
48.6	7.5		10

Formatted: Font color: Auto

Formatted: Font color: Auto

Formatted: Font color: Auto

Formatted: Font color: Auto

▲ 48.5	7.5	10	
▲ 48.4	7.5	10	10
▲ 48.2	7.5	10	10
▲ 48.0	5	10	10
▲ 47.8	5		
▲ Total % Demand	60	40	40

Table ECC.A.5.5.1a

Note – the percentages in table ECC.A.5.5.1a are cumulative such that, for example, should the frequency fall to 48.6 Hz in the **NGET Transmission Area**, 27.5% of the total **Demand** connected to the **National Electricity Transmission System** in the **NGET Transmission Area** shall be disconnected by the action of **Low Frequency Relays**.

The percentage **Demand** at each stage shall be allocated as far as reasonably practicable. The cumulative total percentage **Demand** is a minimum.

ECC.A.5.5.2 In the case of a **Non-Embedded Customer** (who isare also an **EU Code User's**) the percentage of **Demand** (based on **Annual ACS Conditions**) at the time of forecast **National Electricity Transmission System** peak **Demand** that each **Non-Embedded Customer** whose **System** is connected to the **Onshore Transmission System** which shall be disconnected by **Low Frequency Relays** shall be in accordance with OC6.6 and the **Bilateral Agreement**.

ECC.A.5.6 Connection and Reconnection

ECC.A.5.6.1 As defined under OC.6.6 once automatic low **Frequency Demand Disconnection** has taken place, the **Network Operator** on whose **User System** it has occurred, will not reconnect until **NGET** instructs that **Network Operator** to do so in accordance with OC6. The same requirement equally applies to **Non-Embedded Customers**.

ECC.A.5.6.1 Once **NGET** instructs the **Network Operator** or **Non Embedded Customer** to reconnect to the **National Electricity Transmission System** following operation of the **Low Frequency Demand Disconnection** scheme it shall do so in accordance with the requirements of **ECC.6.2.3.10** and **OC6.6**.

ECC.A.5.6.2 **Network Operators's** or **Non Embedded Customers's** shall be capable of being remotely disconnected from the **National Electricity Transmission System** when instructed by **NGET**. Any requirement for the automated disconnection equipment for reconfiguration of the **National Electricity Transmission System** in preparation for block loading and the time required for remote disconnection shall be specified by **NGET** in accordance with the terms of the **Bilateral Agreement**.

- Formatted: Font color: Auto
- Formatted: Font color: Auto
- Formatted: Font color: Auto
- Formatted: Font color: Auto
- Formatted: Font color: Auto
- Formatted: Font color: Auto
- Formatted: Font color: Auto

- Formatted: Font: Bold
- Formatted: Font: Bold
- Formatted: Font: Not Bold
- Formatted: Font: Bold
- Formatted: Font color: Auto

- Formatted: Font: Not Bold
- Formatted: Font: Not Bold

APPENDIX E6 - PERFORMANCE REQUIREMENTS FOR CONTINUOUSLY ACTING AUTOMATIC EXCITATION CONTROL SYSTEMS FOR ONSHORE SYNCHRONOUS POWER GENERATING MODULES,

ECC.A.6.1 Scope

ECC.A.6.1.1 This Appendix sets out the performance requirements of continuously acting automatic excitation control systems for **Type C** and **Type D Onshore Synchronous Power Generating Modules** that must be complied with by the **User**. This Appendix does not limit any site specific requirements where in **NGET's** reasonable opinion these facilities are necessary for system reasons.

ECC.A.6.1.2 Where the requirements may vary the likely range of variation is given in this Appendix. It may be necessary to specify values outside this range where **NGET** identifies a system need, and notwithstanding anything to the contrary **NGET** may specify values outside of the ranges provided in this Appendix 6. The most common variations are in the on-load excitation ceiling voltage requirements and the response time required of the **Exciter**. Actual values will be included in the **Bilateral Agreement**.

ECC.A.6.1.3 Should an **EU Generator** anticipate making a change to the excitation control system it shall notify **NGET** under the **Planning Code** (PC.A.1.2(b) and (c)) as soon as the **EU Generator** anticipates making the change. The change may require a revision to the **Bilateral Agreement**.

ECC.A.6.2 Requirements

ECC.A.6.2.1 The **Excitation System** of a **Type C** or **Type D Onshore Synchronous Power Generating Module** shall include an excitation source (**Exciter**), and a continuously acting **Automatic Voltage Regulator (AVR)** and shall meet the following functional specification. **Type D Synchronous Power Generating Modules** are also required to be fitted with a **Power System Stabiliser** in accordance with the requirements of ECC.A.6.2.5.

ECC.A.6.2.3 Steady State Voltage Control

ECC.A.6.2.3.1 An accurate steady state control of the **Onshore Synchronous Power Generating Module** pre-set **Synchronous Generating Unit** terminal voltage is required. As a measure of the accuracy of the steady-state voltage control, the **Automatic Voltage Regulator** shall have static zero frequency gain, sufficient to limit the change in terminal voltage to a drop not exceeding 0.5% of rated terminal voltage, when the output of a **Synchronous Generating Unit** within an **Onshore Synchronous Power Generating Module** is gradually changed from zero to rated MVA output at rated voltage, **Active Power** and **Frequency**.

ECC.A.6.2.4 Transient Voltage Control

ECC.A.6.2.4.1 For a step change from 90% to 100% of the nominal **Onshore Synchronous Generating Unit** terminal voltage, with the **Onshore Synchronous Generating Unit** on open circuit, the **Excitation System** response shall have a damped oscillatory characteristic. For this characteristic, the time for the **Onshore Synchronous Generating Unit** terminal voltage to first reach 100% shall be less than 0.6 seconds. Also, the time to settle within 5% of the voltage change shall be less than 3 seconds.

ECC.A.6.2.4.2 To ensure that adequate synchronising power is maintained, when the **Onshore Power Generating Module** is subjected to a large voltage disturbance, the **Exciter** whose output is varied by the **Automatic Voltage Regulator** shall be capable of providing its achievable upper and lower limit ceiling voltages to the **Onshore Synchronous Generating Unit** field in a time not exceeding that specified in the **Bilateral Agreement**. This will normally be not less than 50 ms and not greater than 300 ms. The achievable upper and lower limit ceiling voltages may be dependent on the voltage disturbance.

ECC.A.6.2.4.3 The **Exciter** shall be capable of attaining an **Excitation System On Load Positive Ceiling Voltage** of not less than a value specified in the **Bilateral Agreement** that will be:

not less than 2 per unit (pu)

normally not greater than 3 pu

exceptionally up to 4 pu

of **Rated Field Voltage** when responding to a sudden drop in voltage of 10 percent or more at the **Onshore Synchronous Generating Unit** terminals. **NGET** may specify a value outside the above limits where **NGET** identifies a system need.

ECC.A.6.2.4.4 If a static type **Exciter** is employed:

(i) the field voltage should be capable of attaining a negative ceiling level specified in the **Bilateral Agreement** after the removal of the step disturbance of ECC.A.6.2.4.3. The specified value will be 80% of the value specified in ECC.A.6.2.4.3. **NGET** may specify a value outside the above limits where **NGET** identifies a system need.

(ii) the **Exciter** must be capable of maintaining free firing when the **Onshore Synchronous Generating Unit** terminal voltage is depressed to a level which may be between 20% to 30% of rated terminal voltage

(iii) the **Exciter** shall be capable of attaining a positive ceiling voltage not less than 80% of the **Excitation System On Load Positive Ceiling Voltage** upon recovery of the **Onshore Synchronous Generating Unit** terminal voltage to 80% of rated terminal voltage following fault clearance. **NGET** may specify a value outside the above limits where **NGET** identifies a system need.

(iv) the requirement to provide a separate power source for the **Exciter** will be specified if **NGET** identifies a **Transmission System** need.

ECC.A.6.2.5 **Power Oscillations Damping Control**

ECC.A.6.2.5.1 To allow **Type D Onshore Power Generating Modules** to maintain second and subsequent swing stability and also to ensure an adequate level of low frequency electrical damping power, the **Automatic Voltage Regulator** of each **Onshore Synchronous Generating Unit** within each **Type D Onshore Synchronous Power Generating Module** shall include a **Power System Stabiliser** as a means of supplementary control.

ECC.A.6.2.5.2 Whatever supplementary control signal is employed, it shall be of the type which operates into the **Automatic Voltage Regulator** to cause the field voltage to act in a manner which results in the damping power being improved while maintaining adequate synchronising power.

- ECC.A.6.2.5.3 The arrangements for the supplementary control signal shall ensure that the **Power System Stabiliser** output signal relates only to changes in the supplementary control signal and not the steady state level of the signal. For example, if generator electrical power output is chosen as a supplementary control signal then the **Power System Stabiliser** output should relate only to changes in the **Synchronous Generating Unit** electrical power output and not the steady state level of power output. Additionally the **Power System Stabiliser** should not react to mechanical power changes in isolation for example during rapid changes in steady state load or when providing frequency response.
- ECC.A.6.2.5.4 The output signal from the **Power System Stabiliser** shall be limited to not more than $\pm 10\%$ of the **Onshore Synchronous Generating Unit** terminal voltage signal at the **Automatic Voltage Regulator** input. The gain of the **Power System Stabiliser** shall be such that an increase in the gain by a factor of 3 shall not cause instability.
- ECC.A.6.2.5.5 The **Power System Stabiliser** shall include elements that limit the bandwidth of the output signal. The bandwidth limiting must ensure that the highest frequency of response cannot excite torsional oscillations on other plant connected to the network. A bandwidth of 0-5Hz would be judged to be acceptable for this application.
- ECC.A.6.2.5.6 The **EU Generator** in respect of its **Type D Synchronous Power Generating Modules** will agree **Power System Stabiliser** settings with **NGET** prior to the on-load commissioning detailed in BC2.11.2(d). To allow assessment of the performance before on-load commissioning the **EU Generator** will provide to **NGET** a report covering the areas specified in ECP.A.3.2.1.
- ECC.A.6.2.5.7 The **Power System Stabiliser** must be active within the **Excitation System** at all times when **Synchronised** including when the **Under Excitation Limiter** or **Over Excitation Limiter** are active. When operating at low load when **Synchronising** or **De-Synchronising** an **Onshore Synchronous Generating Unit**, within a **Type D Synchronous Power Generating Module**, the **Power System Stabiliser** may be out of service.
- ECC.A.6.2.5.8 Where a **Power System Stabiliser** is fitted to a **Pumped Storage Unit** within a **Type D Synchronous Power Generating Module** it must function when the **Pumped Storage Unit** is in both generating and pumping modes.
- ECC.A.6.2.6 Overall **Excitation System** Control Characteristics
- ECC.A.6.2.6.1 The overall **Excitation System** shall include elements that limit the bandwidth of the output signal. The bandwidth limiting must be consistent with the speed of response requirements and ensure that the highest frequency of response cannot excite torsional oscillations on other plant connected to the network. A bandwidth of 0-5 Hz will be judged to be acceptable for this application.
- ECC.A.6.2.6.2 The response of the **Automatic Voltage Regulator** combined with the **Power System Stabiliser** shall be demonstrated by injecting similar step signal disturbances into the **Automatic Voltage Regulator** reference as detailed in ECPA.5.2 and ECPA.5.4. The **Automatic Voltage Regulator** shall include a facility to allow step injections into the **Automatic Voltage Regulator** voltage reference, with the **Onshore Type D Power Generating Module** operating at points specified by **NGET** (up to rated MVA output). The damping shall be judged to be adequate if the corresponding **Active Power** response to the disturbances decays within two cycles of oscillation.

ECC.A.6.2.6.3 A facility to inject a band limited random noise signal into the **Automatic Voltage Regulator** voltage reference shall be provided for demonstrating the frequency domain response of the **Power System Stabiliser**. The tuning of the **Power System Stabiliser** shall be judged to be adequate if the corresponding **Active Power** response shows improved damping with the **Power System Stabiliser** in combination with the **Automatic Voltage Regulator** compared with the **Automatic Voltage Regulator** alone over the frequency range 0.3Hz – 2Hz.

ECC.A.6.2.7 Under-Excitation Limiters

ECC.A.6.2.7.1 The security of the power system shall also be safeguarded by means of MVar **Under Excitation Limiters** fitted to the **Synchronous Power Generating Module Excitation System**. The **Under Excitation Limiter** shall prevent the **Automatic Voltage Regulator** reducing the **Synchronous Generating Unit** excitation to a level which would endanger synchronous stability. The **Under Excitation Limiter** shall operate when the excitation system is providing automatic control. The **Under Excitation Limiter** shall respond to changes in the **Active Power** (MW) the **Reactive Power** (MVar) and to the square of the **Synchronous Generating Unit** voltage in such a direction that an increase in voltage will permit an increase in leading MVar. The characteristic of the **Under Excitation Limiter** shall be substantially linear from no-load to the maximum **Active Power** output of the **Onshore Power Generating Module** at any setting and shall be readily adjustable.

ECC.A.6.2.7.2 The performance of the **Under Excitation Limiter** shall be independent of the rate of change of the **Onshore Synchronous Power Generating Module** load and shall be demonstrated by testing as detailed in ECP.A.5.5. The resulting maximum overshoot in response to a step injection which operates the **Under Excitation Limiter** shall not exceed 4% of the **Onshore Synchronous Generating Unit** rated MVA. The operating point of the **Onshore Synchronous Generating Unit** shall be returned to a steady state value at the limit line and the final settling time shall not be greater than 5 seconds. When the step change in **Automatic Voltage Regulator** reference voltage is reversed, the field voltage should begin to respond without any delay and should not be held down by the **Under Excitation Limiter**. Operation into or out of the preset limit levels shall ensure that any resultant oscillations are damped so that the disturbance is within 0.5% of the **Onshore Synchronous Generating Unit** MVA rating within a period of 5 seconds.

ECC.A.6.2.7.3 The **EU Generator** shall also make provision to prevent the reduction of the **Onshore Synchronous Generating Unit** excitation to a level which would endanger synchronous stability when the **Excitation System** is under manual control.

ECC.A.6.2.8 Over-Excitation and Stator Current Limiters

ECC.A.6.2.8.1 The settings of the **Over-Excitation Limiter** and stator current limiter, shall ensure that the **Onshore Synchronous Generating Unit** excitation is not limited to less than the maximum value that can be achieved whilst ensuring the **Onshore Synchronous Generating Unit** is operating within its design limits. If the **Onshore Synchronous Generating Unit** excitation is reduced following a period of operation at a high level, the rate of reduction shall not exceed that required to remain within any time dependent operating characteristics of the **Onshore Synchronous Power Generating Module**.

ECC.A.6.2.8.2 The performance of the **Over-Excitation Limiter**, shall be demonstrated by testing as described in ECP.A.5.6. Any operation beyond the **Over-Excitation Limit** shall be controlled by the **Over-Excitation Limiter** or stator current limiter without the operation of any **Protection** that could trip the **Onshore Synchronous Power Generating Module**.

ECC.A.6.2.8.3 The **EU Generator** shall also make provision to prevent any over-excitation restriction of the **Onshore Synchronous Generating Unit** when the **Excitation System** is under manual control, other than that necessary to ensure the **Onshore Power Generating Module** is operating within its design limits.

APPENDIX E7 - PERFORMANCE REQUIREMENTS FOR CONTINUOUSLY ACTING AUTOMATIC VOLTAGE CONTROL SYSTEMS FOR AC CONNECTED ONSHORE POWER PARK MODULES AND OTSDUW PLANT AND APPARATUS AT THE INTERFACE POINT HVDC SYSTEMS AND REMOTE END HVDC CONVERTER STATIONS

ECC.A.7.1 Scope

ECC.A.7.1.1 This Appendix sets out the performance requirements of continuously acting automatic voltage control systems for **Onshore Power Park Modules, Onshore HVDC Converters Remote End HVDC Converter Stations and OTSDUW Plant and Apparatus at the Interface Point** that must be complied with by the **User**. This Appendix does not limit any site specific requirements where in **NGET's** reasonable opinion these facilities are necessary for system reasons. The control performance requirements applicable to **Configuration 2 AC Connected Offshore Power Park Modules and Configuration 2 DC Connected Power Park Modules** are defined in Appendix E8.

ECC.A.7.1.2 Proposals by **EU Generators or HVDC System Owners** to make a change to the voltage control systems are required to be notified to **NGET** under the **Planning Code (PC.A.1.2(b) and (c))** as soon as the **Generator or HVDC System Owner** anticipates making the change. The change may require a revision to the **Bilateral Agreement**.

ECC.A.7.1.3 In the case of a **Remote End HVDC Converter** at a **HVDC Converter Station**, the control performance requirements shall be specified in the **Bilateral Agreement**. These requirements shall be consistent with those specified in ECC.6.3.2.4. In the case where the **Remote End HVDC Converter** is required to ensure the zero transfer of **Reactive Power** at the **HVDC Interface Point** then the requirements shall be specified in the **Bilateral Agreement** which shall be consistent with those requirements specified in ECC.A.8. In the case where a wider reactive capability has been specified in ECC.6.3.2.4, then the requirements consistent with those specified in ECC.A.7.2 shall apply with any variations being agreed between the **User** and **NGET**.

ECC.A.7.2 Requirements

ECC.A.7.2.1 **NGET** requires that the continuously acting automatic voltage control system for the **Onshore Power Park Module, Onshore HVDC Converter or OTSDUW Plant and Apparatus** shall meet the following functional performance specification. If a **Network Operator** has confirmed to **NGET** that its network to which an **Embedded Onshore Power Park Module or Onshore HVDC Converter or OTSDUW Plant and Apparatus** is connected is restricted such that the full reactive range under the steady state voltage control requirements (ECC.A.7.2.2) cannot be utilised, **NGET** may specify alternative limits to the steady state voltage control range that reflect these restrictions. Where the **Network Operator** subsequently notifies **NGET** that such restriction has been removed, **NGET** may propose a **Modification** to the **Bilateral Agreement** (in accordance with the **CUSC** contract) to remove the alternative limits such that the continuously acting automatic voltage control system meets the following functional performance specification. All other requirements of the voltage control system will remain as in this Appendix.

ECC.A.7.2.2 Steady State Voltage Control

ECC.A.7.2.2.1 The **Onshore Power Park Module, Onshore HVDC Converter or OTSDUW Plant and Apparatus** shall provide continuous steady state control of the voltage at the **Onshore Grid Entry Point** (or **Onshore User System Entry Point** if **Embedded**) (or the **Interface Point** in the case of **OTSDUW Plant and Apparatus**) with a **Setpoint Voltage** and **Slope** characteristic as illustrated in Figure ECC.A.7.2.2a.

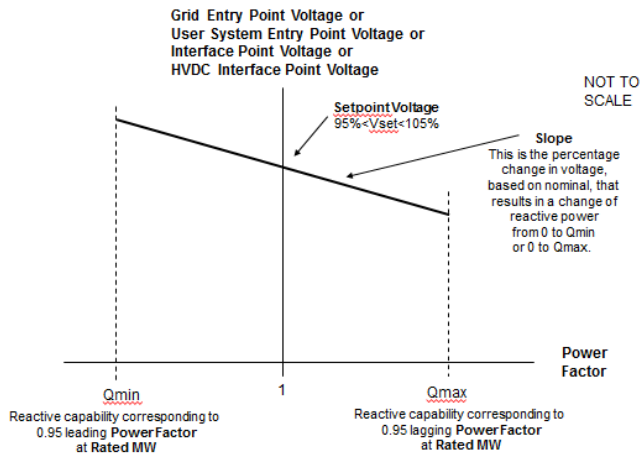

Figure ECC.A.7.2.2a

ECC.A.7.2.2.2 The continuously acting automatic control system shall be capable of operating to a **Setpoint Voltage** between 95% and 105% with a resolution of 0.25% of the nominal voltage. For the avoidance of doubt values of 95%, 95.25%, 95.5% ... may be specified, but not intermediate values. The initial **Setpoint Voltage** will be 100%. The tolerance within which this **Setpoint Voltage** shall be achieved is specified in BC2.A.2.6. For the avoidance of doubt, with a tolerance of 0.25% and a Setpoint Voltage of 100%, the achieved value shall be between 99.75% and 100.25%. **NGET** may request the **EU Generator** or **HVDC System Owner** to implement an alternative **Setpoint Voltage** within the range of 95% to 105%. For **Embedded Generators** and **Embedded HVDC System Owners** the **Setpoint Voltage** will be discussed between **NGET** and the relevant **Network Operator** and will be specified to ensure consistency with ECC.6.3.4.

ECC.A.7.2.2.3 The **Slope** characteristic of the continuously acting automatic control system shall be adjustable over the range 2% to 7% (with a resolution of 0.5%). For the avoidance of doubt values of 2%, 2.5%, 3% may be specified, but not intermediate values. The initial **Slope** setting will be 4%. The tolerance within which this **Slope** shall be achieved is specified in BC2.A.2.6. For the avoidance of doubt, with a tolerance of 0.5% and a **Slope** setting of 4%, the achieved value shall be between 3.5% and 4.5%. **NGET** may request the **EU Generator** or **HVDC System Owner** to implement an alternative slope setting within the range of 2% to 7%. For **Embedded Generators** and **Onshore Embedded HVDC Converter Station Owners** the **Slope** setting will be discussed between **NGET** and the relevant **Network Operator** and will be specified to ensure consistency with ECC.6.3.4.

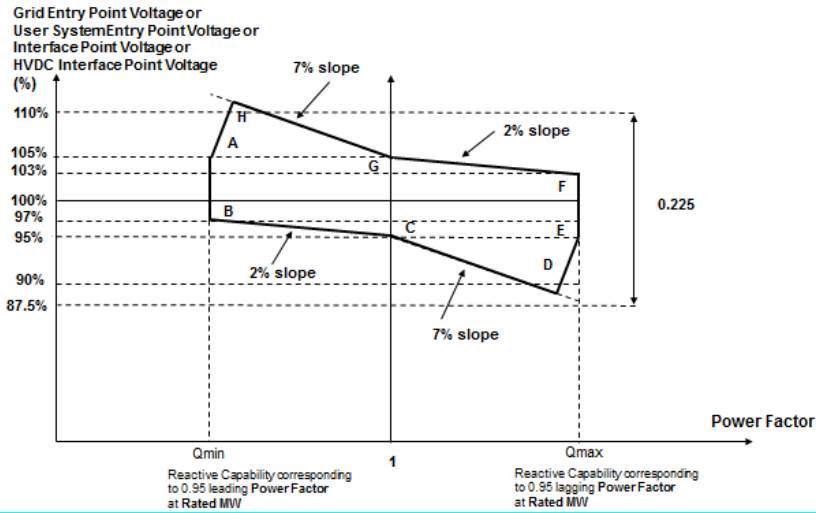

Figure ECC.A.7.2.2b

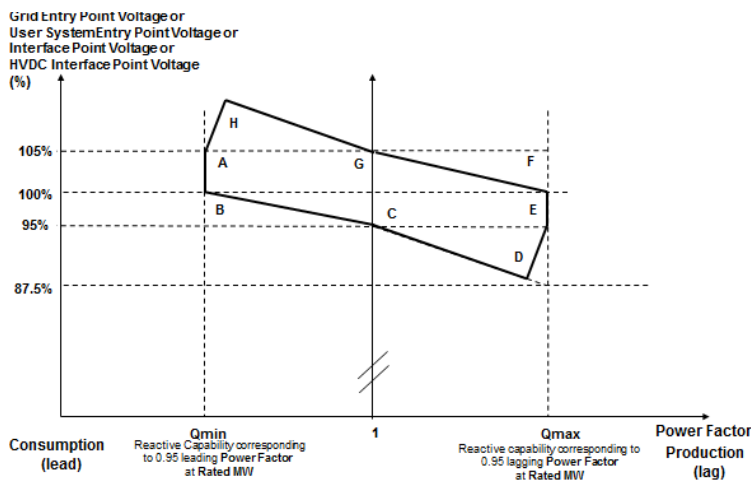

Figure ECC.A.7.2.2c

ECC.A.7.2.2.4 Figure ECC.A.7.2.2b shows the required envelope of operation for -, OTSDUW Plant and Apparatus, Onshore Power Park Modules and Onshore HVDC Converters except for those Embedded at 33kV and below or directly connected to the National Electricity Transmission System at 33kV and below. Figure ECC.A.7.2.2c shows the required envelope of operation for Onshore Power Park Modules Embedded at 33kV and below, or directly connected to the National Electricity Transmission System at 33kV and below. The enclosed area within points ABCDEFGH is the required capability range within which the Slope and Setpoint Voltage can be changed.

ECC.A.7.2.2.5 Should the operating point of the, **OTSDUW Plant and Apparatus** or **Onshore Power Park Module**, or **Onshore HVDC Converter** deviate so that it is no longer a point on the operating characteristic (figure ECC.A.7.2.2a) defined by the target **Setpoint Voltage** and **Slope**, the continuously acting automatic voltage control system shall act progressively to return the value to a point on the required characteristic within 5 seconds.

ECC.A.7.2.2.6 Should the **Reactive Power** output of the **OTSDUW Plant and Apparatus** or **Onshore Power Park Module** or **Onshore HVDC Converter** reach its maximum lagging limit at a **Onshore Grid Entry Point** voltage (or **Onshore User System Entry Point** voltage if **Embedded** (or **Interface Point** in the case of **OTSDUW Plant and Apparatus**) above 95%, the **OTSDUW Plant and Apparatus** or **Onshore Power Park Module** or **HVDC System** shall maintain maximum lagging **Reactive Power** output for voltage reductions down to 95%. This requirement is indicated by the line EF in figures ECC.A.7.2.2b and ECC.A.7.2.2c as applicable. Should the **Reactive Power** output of the **OTSDUW Plant and Apparatus** or **Onshore Power Park Module**, or **Onshore HVDC Converter** reach its maximum leading limit at a **Onshore Grid Entry Point** voltage (or **Onshore User System Entry Point** voltage if **Embedded** or **Interface Point** in the case of **OTSDUW Plant and Apparatus**) below 105%, the **OTSDUW Plant and Apparatus** or **Onshore Power Park Module**, or **Onshore HVDC Converter** shall maintain maximum leading **Reactive Power** output for voltage increases up to 105%. This requirement is indicated by the line AB in figures ECC.A.7.2.2b and ECC.A.7.2.2c as applicable.

ECC.A.7.2.2.7 For **Onshore Grid Entry Point** voltages (or **Onshore User System Entry Point** voltages if **Embedded**-or **Interface Point** voltages) below 95%, the lagging **Reactive Power** capability of the **OTSDUW Plant and Apparatus** or **Onshore Power Park Module** or **Onshore HVDC Converters** should be that which results from the supply of maximum lagging reactive current whilst ensuring the current remains within design operating limits. An example of the capability is shown by the line DE in figures ECC.A.7.2.2b and ECC.A.7.2.2c. For **Onshore Grid Entry Point** voltages (or **User System Entry Point** voltages if **Embedded** or **Interface Point** voltages) above 105%, the leading **Reactive Power** capability of the **OTSDUW Plant and Apparatus** or **Onshore Power Park Module** or **Onshore HVDC System Converter** should be that which results from the supply of maximum leading reactive current whilst ensuring the current remains within design operating limits. An example of the capability is shown by the line AH in figures ECC.A.7.2.2b and ECC.A.7.2.2c as applicable. Should the **Reactive Power** output of the **OTSDUW Plant and Apparatus** or **Onshore Power Park Module** or **Onshore HVDC Converter** reach its maximum lagging limit at an **Onshore Grid Entry Connection Point** voltage (or **Onshore User System Entry Point** voltage if **Embedded** or **Interface Point** in the case of **OTSDUW Plant and Apparatus**) below 95%, the **Onshore Power Park Module**, **Onshore HVDC Converter** shall maintain maximum lagging reactive current output for further voltage decreases. Should the **Reactive Power** output of the **OTSDUW Plant and Apparatus** or **Onshore Power Park Module** or **Onshore HVDC Converter** reach its maximum leading limit at a **Onshore Grid Entry Point** voltage (or **User System Entry Point** voltage if **Embedded** or **Interface Point** voltage in the case of an **OTSDUW Plant and Apparatus**) above 105%, the **OTSDUW Plant and Apparatus** or **Onshore Power Park Module** or **Onshore HVDC Converter** shall maintain maximum leading reactive current output for further voltage increases.

ECC.A.7.2.2.8 All **OTSDUW Plant and Apparatus** must be capable of enabling **EU Code Users** undertaking **OTSDUW** to comply with an instruction received from **NGET** relating to a variation of the **Setpoint Voltage** at the **Interface Point** within 2 minutes of such instruction being received.

ECC.A.7.2.2.9 For **OTSDUW Plant and Apparatus** connected to a **Network Operator's System** where the **Network Operator** has confirmed to **NGET** that its **System** is restricted in accordance with ECC.A.7.2.1, clause ECC.A.7.2.2.8 will not apply unless **NGET** can reasonably demonstrate that the magnitude of the available change in **Reactive Power** has a significant effect on voltage levels on the **Onshore National Electricity Transmission System**.

ECC.A.7.2.3 **Transient Voltage Control**

ECC.A.7.2.3.1 For an on-load step change in **Onshore Grid Entry Point** or **Onshore User System Entry Point** voltage, or in the case of **OTSDUW Plant and Apparatus** an on-load step change in **Transmission Interface Point** voltage, the continuously acting automatic control system shall respond according to the following minimum criteria:

- (i) the **Reactive Power** output response of the, **OTSDUW Plant and Apparatus** or **Onshore Power Park Module** or **Onshore HVDC Converter** shall commence within 0.2 seconds of the application of the step. It shall progress linearly although variations from a linear characteristic shall be acceptable provided that the MVAR seconds delivered at any time up to 1 second are at least those that would result from the response shown in figure ECC.A.7.2.3.1a.
- (ii) the response shall be such that 90% of the change in the **Reactive Power** output of the, **OTSDUW Plant and Apparatus** or **Onshore Power Park Module**, or **Onshore HVDC Converter** will be achieved within
 - 2 seconds, where the step is sufficiently large to require a change in the steady state **Reactive Power** output from its maximum leading value to its maximum lagging value or vice versa and
 - 1 second where the step is sufficiently large to require a change in the steady state **Reactive Power** output from zero to its maximum leading value or maximum lagging value as required by ECC.6.3.2 (or, if appropriate ECC.A.7.2.2.6 or ECC.A.7.2.2.7);
- (iii) the magnitude of the **Reactive Power** output response produced within 1 second shall vary linearly in proportion to the magnitude of the step change.
- (iv) within 5 seconds from achieving 90% of the response as defined in ECC.A.7.2.3.1 (ii), the peak to peak magnitude of any oscillations shall be less than 5% of the change in steady state maximum **Reactive Power**.
- (v) following the transient response, the conditions of ECC.A.7.2.2 apply.

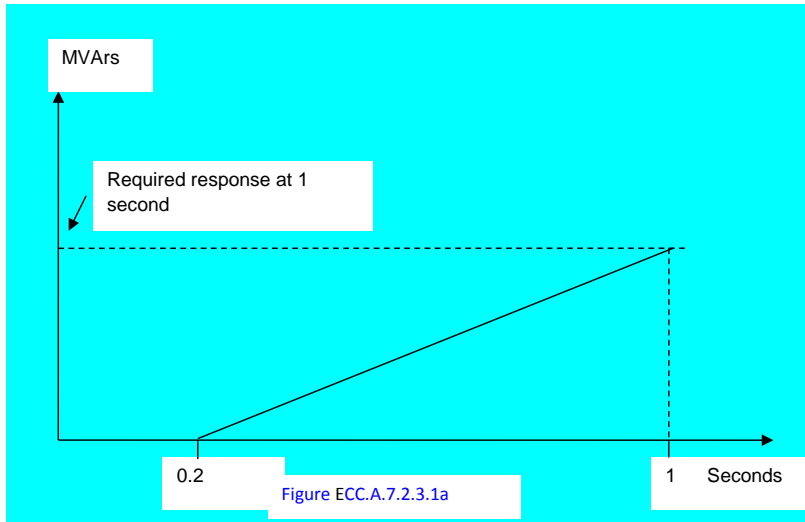

ECC.A.7.2.3.2 OTSDUW Plant and Apparatus or Onshore Power Park Modules or Onshore HVDC Converters shall be capable of

- (a) changing its **Reactive Power** output from its maximum lagging value to its maximum leading value, or vice versa, then reverting back to the initial level of **Reactive Power** output once every 15 seconds for at least 5 times within any 5 minute period; and
- (b) changing its **Reactive Power** output from zero to its maximum leading value then reverting back to zero **Reactive Power** output at least 25 times within any 24 hour period and from zero to its maximum lagging value then reverting back to zero **Reactive Power** output at least 25 times within any 24 hour period. Any subsequent restriction on reactive capability shall be notified to **NGET** in accordance with BC2.5.3.2, and BC2.6.1.

In all cases, the response shall be in accordance to ECC.A.7.2.3.1 where the change in **Reactive Power** output is in response to an on-load step change in **Onshore Grid Entry Point** or **Onshore User System Entry Point** voltage, or in the case of **OTSDUW Plant and Apparatus** an on-load step change in **Transmission Interface Point** voltage.

ECC.A.7.2.4 Power Oscillation Damping

ECC.A.7.2.4.1 The requirement for the continuously acting voltage control system to be fitted with a **Power System Stabiliser (PSS)** shall be specified if, in **NGET's** view, this is required for system reasons. However if a **Power System Stabiliser** is included in the voltage control system its settings and performance shall be agreed with **NGET** and commissioned in accordance with BC2.11.2. To allow assessment of the performance before on-load commissioning the **Generator** will provide to **NGET** a report covering the areas specified in ECP.A.3.2.2.

ECC.A.7.2.5 Overall Voltage Control System Characteristics

ECC.A.7.2.5.1 The continuously acting automatic voltage control system is required to respond to minor variations, steps, gradual changes or major variations in **Onshore Grid Entry Point** voltage (or **Onshore User System Entry Point** voltage if **Embedded** or **Interface Point** voltage in the case of **OTSDUW Plant and Apparatus**).

ECC.A.7.2.5.2 The overall voltage control system shall include elements that limit the bandwidth of the output signal. The bandwidth limiting must be consistent with the speed of response requirements and ensure that the highest frequency of response cannot excite torsional oscillations on other plant connected to the network. A bandwidth of 0-5Hz would be judged to be acceptable for this application. All other control systems employed within the **OTSDUW Plant and Apparatus** or **Onshore Power Park Module** or **Onshore HVDC Converter** should also meet this requirement

ECC.A.7.2.5.3 The response of the voltage control system (including the **Power System Stabiliser** if employed) shall be demonstrated by testing in accordance with ECP.A.6.

ECC.A.7.3 **Reactive Power Control**

ECC.A.7.3.1 As defined in ECC.6.3.8.3.4, **Reactive Power** control mode of operation is not required in respect of **Onshore Power Park Modules** or **OTSDUW Plant and Apparatus** or **Onshore HVDC Converters** unless otherwise specified by **NGET** in coordination with the relevant **Network Operator**. However where there is a requirement for **Reactive Power** control mode of operation, the following requirements shall apply.

ECC.A.7.3.2 The **Onshore Power Park Module** or **OTSDUW Plant and Apparatus** or **Onshore HVDC Converter** shall be capable of setting the **Reactive Power** setpoint anywhere in the **Reactive Power** range as specified in ECC.6.3.2.4 with setting steps no greater than 5 MVar or 5% (whichever is smaller) of full **Reactive Power**, controlling the reactive power at the **Grid Entry Point** or **User System Entry Point** if **Embedded** to an accuracy within plus or minus 5MVar or plus or minus 5% (whichever is smaller) of the full **Reactive Power**.

ECC.A.7.3.3 Any additional requirements for **Reactive Power** control mode of operation shall be specified by **NGET** in coordination with the relevant **Network Operator**.

ECC.A.7.4 **Power Factor Control**

ECC.A.7.4.1 As defined in ECC.6.3.8.4.3, **Power Factor** control mode of operation is not required in respect of **Onshore Power Park Modules** or **OTSDUW Plant and Apparatus** or **Onshore HVDC Converters** unless otherwise specified by **NGET** in coordination with the relevant **Network Operator**. However where there is a requirement for **Power Factor** control mode of operation, the following requirements shall apply.

ECC.A.7.4.2 The **Onshore Power Park Module** or **OTSDUW Plant and Apparatus** or **Onshore HVDC Converter** shall be capable of controlling the **Power Factor** at the **Grid Entry Point** or **User System Entry Point** (if **Embedded**) within the required **Reactive Power** range as specified in ECC.6.3.2.2.1 and ECC.6.3.2.4 to a specified target **Power Factor**. **NGET** shall specify the target **Power Factor** value (which shall be achieved within 0.01 of the set **Power Factor**), its tolerance and the period of time to achieve the target **Power Factor** following a sudden change of **Active Power** output. The tolerance of the target **Power Factor** shall be expressed through the tolerance of its corresponding **Reactive Power**. This **Reactive Power** tolerance shall be expressed by either an absolute value or by a percentage of the maximum **Reactive Power** of the **Onshore Power Park Module** or **OTSDUW Plant and**

Apparatus or Onshore HVDC Converter. The details of these requirements being pursuant to the terms of the **Bilateral Agreement**.

ECC.A.7.4.3 Any additional requirements for **Power Factor** control mode of operation shall be specified by **NGET** in coordination with the relevant **Network Operator**.

APPENDIX E8 - PERFORMANCE REQUIREMENTS FOR CONTINUOUSLY ACTING AUTOMATIC VOLTAGE CONTROL SYSTEMS FOR CONFIGURATION 2 AC CONNECTED OFFSHORE POWER PARK MODULES AND CONFIGURATION 2 DC CONNECTED POWER PARK MODULES

ECC.A.8.1 Scope

ECC.A.8.1.1 This Appendix sets out the performance requirements of continuously acting automatic voltage control systems for **Configuration 2 AC Connected Offshore Power Park Modules** and **Configuration 2 DC Connected Power Park Modules** that must be complied with by the **EU Code User**. This Appendix does not limit any site specific requirements that may be specified where in **NGET's** reasonable opinion these facilities are necessary for system reasons.

ECC.A.8.1.2 These requirements also apply to **Configuration 2 DC Connected Power Park Modules**. In the case of a **Configuration 1 DC Connected Power Park Module** the technical performance requirements shall be specified by **NGET**. Where the **EU Generator** in respect of a **DC Connected Power Park Module** has agreed to a wider reactive capability range as defined under ECC.6.3.2.5 and ECC.6.2.3.6 then the requirements that apply will be specified by **NGET** and which shall reflect the performance requirements detailed in ECC.A.8.2 below but with different parameters such as droop and **Setpoint Voltage**.

ECC.A.8.1.3 Proposals by **EU Generators** to make a change to the voltage control systems are required to be notified to **NGET** under the **Planning Code** (PC.A.1.2(b) and (c)) as soon as the **Generator** anticipates making the change. The change may require a revision to the **Bilateral Agreement**.

ECC.A.8.2 Requirements

ECC.A.8.2.1 **NGET** requires that the continuously acting automatic voltage control system for the **Configuration 2 AC connected Offshore Power Park Module** and **Configuration 2 DC Connected Power Park Module** shall meet the following functional performance specification.

ECC.A.8.2.2 Steady State Voltage Control

ECC.A.8.2.2.1 The **Configuration 2 AC connected Offshore Power Park Module** and **Configuration 2 DC Connected Power Park Module** shall provide continuous steady state control of the voltage at the **Offshore Connection Point** with a **Setpoint Voltage** and **Slope** characteristic as illustrated in Figure ECC.A.8.2.2a.

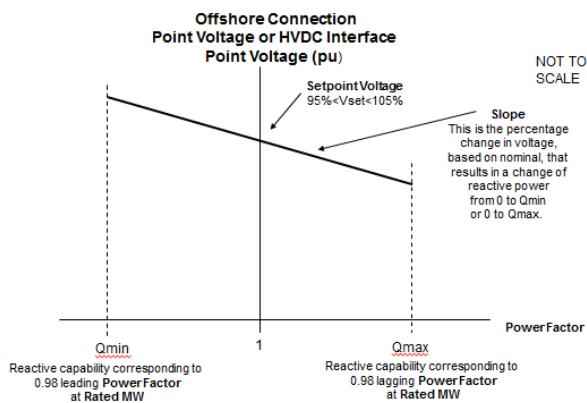

Figure ECC.A.8.2.2a

ECC.A.8.2.2.2 The continuously acting automatic control system shall be capable of operating to a **Setpoint Voltage** between 95% and 105% with a resolution of 0.25% of the nominal voltage. For the avoidance of doubt values of 95%, 95.25%, 95.5% ... may be specified, but not intermediate values. The initial **Setpoint Voltage** will be 100%. The tolerance within which this **Setpoint Voltage** shall be achieved is specified in BC2.A.2.6. For the avoidance of doubt, with a tolerance of 0.25% and a Setpoint Voltage of 100%, the achieved value shall be between 99.75% and 100.25%. **NETG** may request the **EU Generator** to implement an alternative **Setpoint Voltage** within the range of 95% to 105%.

ECC.A.8.2.2.3 The **Slope** characteristic of the continuously acting automatic control system shall be adjustable over the range 2% to 7% (with a resolution of 0.5%). For the avoidance of doubt values of 2%, 2.5%, 3% may be specified, but not intermediate values. The initial **Slope** setting will be 4%. The tolerance within which this **Slope** shall be achieved is specified in BC2.A.2.6. For the avoidance of doubt, with a tolerance of 0.5% and a **Slope** setting of 4%, the achieved value shall be between 3.5% and 4.5%. **NETG** may request the **EU Generator** to implement an alternative slope setting within the range of 2% to 7%.

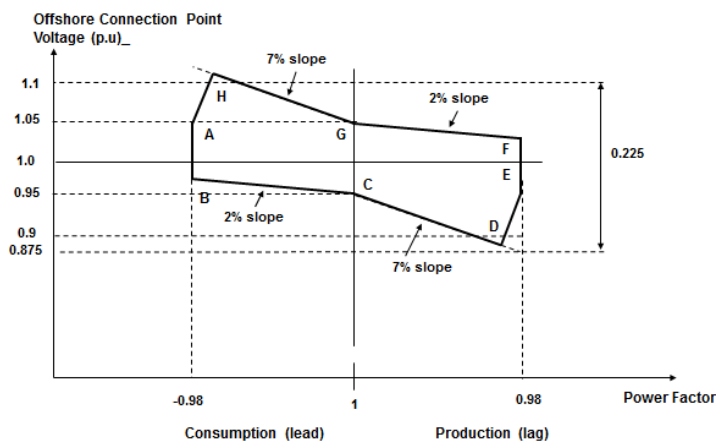

Figure ECC.A.8.2.2b

ECC.A.8.2.2.4 Figure ECC.A.8.2.2b shows the required envelope of operation for **Configuration 2 AC connected Offshore Power Park Module** and **Configuration 2 DC Connected Power Park Module**. The enclosed area within points ABCDEFGH is the required capability range within which the **Slope** and **Setpoint Voltage** can be changed.

ECC.A.8.2.2.5 Should the operating point of the **Configuration 2 AC connected Offshore Power Park** or **Configuration 2 DC Connected Power Park Module** deviate so that it is no longer a point on the operating characteristic (Figure ECC.A.8.2.2a) defined by the target **Setpoint Voltage** and **Slope**, the continuously acting automatic voltage control system shall act progressively to return the value to a point on the required characteristic within 5 seconds.

ECC.A.8.2.2.6 Should the **Reactive Power** output of the **Configuration 2 AC connected Offshore Power Park Module** or **Configuration 2 DC Connected Power Park Module** reach its maximum lagging limit at an **Offshore Grid Entry Point** or **Offshore User System Entry Point** or **HVDC Interface Point** voltage above 95%, the **Configuration 2 AC connected Offshore Power Park Module** or **Configuration 2 DC Connected Power Park Module** shall maintain maximum lagging **Reactive Power** output for voltage reductions down to 95%. This requirement is indicated by the line EF in figure ECC.A.8.2.2b. Should the **Reactive Power** output of the **Configuration 2 AC connected Offshore Power Park Module** or **Configuration 2 DC Connected Power Park Module** reach its maximum leading limit at the **Offshore Grid Entry Point** or **Offshore User System Entry Point** or **HVDC Interface Point** voltage below 105%, the **Configuration 2 AC connected Offshore Power Park Module** or **Configuration 2 DC Connected Power Park Module** shall maintain maximum leading **Reactive Power** output for voltage increases up to 105%. This requirement is indicated by the line AB in figures ECC.A.8.2.2b.

ECC.A.8.2.2.7 For **Offshore Grid Entry Point** or **User System Entry Point** or **HVDC Interface Point** voltages below 95%, the lagging **Reactive Power** capability of the **Configuration 2 AC connected Offshore Power Park Module** or **Configuration 2 DC Connected Power Park Module** should be that which results from the supply of maximum lagging reactive current whilst ensuring the current remains within design operating limits. An example of the capability is shown by the line DE in figures ECC.A.8.2.2b. For **Offshore Grid Entry Point** or **Offshore User System Entry Point** voltages or **HVDC Interface Point** voltages above 105%, the leading **Reactive Power** capability of the **Configuration 2 AC connected Offshore Power Park Module** or **Configuration 2 DC Connected Power Park Module** should be that which results from the supply of maximum leading reactive current whilst ensuring the current remains within design operating limits. An example of the capability is shown by the line AH in figures ECC.A.8.2.2b. Should the **Reactive Power** output of the **Configuration 2 AC connected Offshore Power Park Module** or **Configuration 2 DC Connected Power Park Module** reach its maximum lagging limit at an **Offshore Grid Entry Point** or **Offshore User System Entry Point** voltage or **HVDC Interface Point** voltage below 95%, the **Configuration 2 AC connected Offshore Power Park Module** or **Configuration 2 DC Connected Power Park Module** shall maintain maximum lagging reactive current output for further voltage decreases. Should the **Reactive Power** output of the **Configuration 2 AC connected Offshore Power Park Module** or **Configuration 2 DC Connected Power Park Module** reach its maximum leading limit at an **Offshore Grid Entry Point** or **Offshore User System Entry Point** voltage or **HVDC Interface Point** voltage above 105%, the **Configuration 2 AC connected Offshore Power Park Module** or **Configuration 2 DC Connected Power Park Module** shall maintain maximum leading reactive current output for further voltage increases.

ECC.A.8.2.3 Transient Voltage Control

ECC.A.8.2.3.1 For an on-load step change in **Offshore Grid Entry Point** or **Offshore User System Entry Point** voltage or **HVDC Interface Point** voltage, the continuously acting automatic control system shall respond according to the following minimum criteria:

- (i) the **Reactive Power** output response of the **Configuration 2 AC connected Offshore Power Park Module** or **Configuration 2 DC Connected Power Park Module** shall commence within 0.2 seconds of the application of the step. It shall progress linearly although variations from a linear characteristic shall be acceptable provided that the MVar seconds delivered at any time up to 1 second are at least those that would result from the response shown in figure ECC.A.8.2.3.1a.

- (ii) the response shall be such that 90% of the change in the **Reactive Power** output of the **Configuration 2 AC connected Offshore Power Park Module** or **Configuration 2 DC Connected Power Park Module** will be achieved within
- 2 seconds, where the step is sufficiently large to require a change in the steady state **Reactive Power** output from its maximum leading value to its maximum lagging value or vice versa and
 - 1 second where the step is sufficiently large to require a change in the steady state **Reactive Power** output from zero to its maximum leading value or maximum lagging value as required by ECC.6.3.2 (or, if appropriate ECC.A.8.2.2.6 or ECC.A.8.2.2.7);
- (iii) the magnitude of the **Reactive Power** output response produced within 1 second shall vary linearly in proportion to the magnitude of the step change.
- (iv) within 5 seconds from achieving 90% of the response as defined in ECC.A.8.2.3.1 (ii), the peak to peak magnitude of any oscillations shall be less than 5% of the change in steady state maximum **Reactive Power**.
- (v) following the transient response, the conditions of ECC.A.8.2.2 apply.

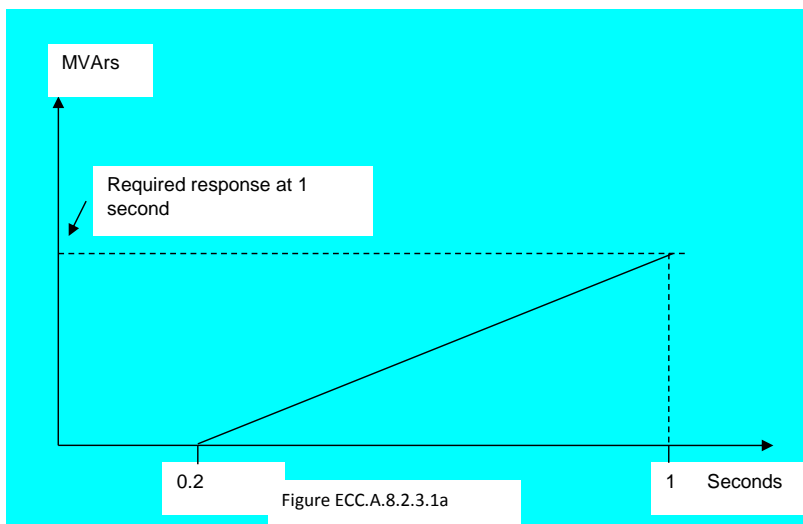

ECC.A.8.2.3.2 Configuration 2 AC connected Offshore Power Park Module or Configuration 2 DC Connected Power Park Module shall be capable of

- (a) changing their **Reactive Power** output from maximum lagging value to maximum leading value, or vice versa, then reverting back to the initial level of **Reactive Power** output once every 15 seconds for at least 5 times within any 5 minute period; and
- (b) changing **Reactive Power** output from zero to maximum leading value then reverting back to zero **Reactive Power** output at least 25 times within any 24 hour period and from zero to its maximum lagging value then reverting back to zero **Reactive Power** output at least 25 times within any 24 hour period. Any subsequent restriction on

reactive capability shall be notified to NGET in accordance with BC2.5.3.2, and BC2.6.1.

In all cases, the response shall be in accordance to ECC.A.8.2.3.1 where the change in Reactive Power output is in response to an on-load step change in Offshore Grid Entry Point or Offshore User System Entry Point voltage or HVDC Interface Point voltage.

ECC.A.8.2.4 Power Oscillation Damping

ECC.A.8.2.4.1 The requirement for the continuously acting voltage control system to be fitted with a Power System Stabiliser (PSS) shall be specified if, in NGET's view, this is required for system reasons. However if a Power System Stabiliser is included in the voltage control system its settings and performance shall be agreed with NGET and commissioned in accordance with BC2.11.2. To allow assessment of the performance before on-load commissioning the Generator or HVDC System Owner will provide to NGET a report covering the areas specified in ECP.A.3.2.2.

ECC.A.8.2.5 Overall Voltage Control System Characteristics

ECC.A.8.2.5.1 The continuously acting automatic voltage control system is required to respond to minor variations, steps, gradual changes or major variations in Offshore Grid Entry Point or Offshore User System Entry Point or HVDC Interface Point voltage.

ECC.A.8.2.5.2 The overall voltage control system shall include elements that limit the bandwidth of the output signal. The bandwidth limiting must be consistent with the speed of response requirements and ensure that the highest frequency of response cannot excite torsional oscillations on other plant connected to the network. A bandwidth of 0-5Hz would be judged to be acceptable for this application. All other control systems employed within the Configuration 2 AC connected Offshore Power Park Module or Configuration 2 DC Connected Power Park Module should also meet this requirement.

ECC.A.8.2.5.3 The response of the voltage control system (including the Power System Stabiliser if employed) shall be demonstrated by testing in accordance with ECP.A.6.

ECC.A.8.3 Reactive Power Control

ECC.A.8.3.1 Reactive Power control mode of operation is not required in respect of Configuration 2 AC connected Offshore Power Park Modules or Configuration 2 DC Connected Power Park Modules unless otherwise specified by NGET. However where there is a requirement for Reactive Power control mode of operation, the following requirements shall apply.

ECC.A.8.3.2 Configuration 2 AC connected Offshore Power Park Modules or Configuration 2 DC Connected Power Park Modules shall be capable of setting the Reactive Power setpoint anywhere in the Reactive Power range as specified in ECC.6.3.2.8.2 with setting steps no greater than 5 MVAR or 5% (whichever is smaller) of full Reactive Power, controlling the Reactive Power at the Offshore Grid Entry Point or Offshore User System Entry Point or HVDC Interface Point to an accuracy within plus or minus 5MVAR or plus or minus 5% (whichever is smaller) of the full Reactive Power.

ECC.A.8.3.3 Any additional requirements for Reactive Power control mode of operation shall be specified by NGET.

ECC.A.8.4 Power Factor Control

ECC.A.8.4.1 **Power Factor** control mode of operation is not required in respect of **Configuration 2 AC connected Offshore Power Park Modules** or **Configuration 2 DC Connected Power Park Modules** unless otherwise specified by **NGET**. However where there is a requirement for **Power Factor** control mode of operation, the following requirements shall apply.

ECC.A.8.4.2 **Configuration 2 AC connected Offshore Power Park Modules** or **Configuration 2 DC Connected Power Park Modules** shall be capable of controlling the **Power Factor** at the **Offshore Grid Entry Point** or **Offshore User System Entry Point** or **HVDC Interface Point** within the required **Reactive Power** range as specified in ECC.6.3.2.8.2 with a target **Power Factor**. **NGET** shall specify the target **Power Factor** (which shall be achieved to within 0.01 of the set **Power Factor**), its tolerance and the period of time to achieve the target **Power Factor** following a sudden change of **Active Power** output. The tolerance of the target **Power Factor** shall be expressed through the tolerance of its corresponding **Reactive Power**. This **Reactive Power** tolerance shall be expressed by either an absolute value or by a percentage of the maximum **Reactive Power** of the **Configuration 2 AC connected Offshore Power Park Module** or **Configuration 2 DC Connected Power Park Module**. The details of these requirements being specified by **NGET**.

ECC.A.8.4.3 Any additional requirements for **Power Factor** control mode of operation shall be specified by **NGET**.

< END OF EUROPEAN CONNECTION CONDITIONS >

GC0104

Formatted: Font: 11 pt

EUROPEAN COMPLIANCE PROCESSES (ECP) LEGAL TEXT

DATED 24/04/2018

1) Blue Highlighted Text – Taken from GC0102 Code Administrator Consultation dated 12/01/2018 - Not relevant for DCC

2) Black – Relevant text for GC0104

3) Track change marked text – relevant changes for GC0104

DRAFT

EUROPEAN COMPLIANCE PROCESSES

CONTENTS

(This contents page does not form part of the Grid Code)

Paragraph No/Title	Page No
ECP.1 INTRODUCTION	4
ECP.2 OBJECTIVE	5
ECP.3 SCOPE.....	6
ECP.4 CONNECTION PROCESS	76
ECP.5 ENERGISATION OPERATIONAL NOTIFICATION	8
ECP.6 OPERATIONAL NOTIFICATION PROCESSES	9
ECP.6.1 OPERATIONAL NOTIFICATION PROCESS (Type A)	9
ECP.6.2 INTERIM OPERATIONAL NOTIFICATION (Type B and Type C)	10
ECP.6.3 INTERIM OPERATIONAL NOTIFICATION (Type D and HVDC Equipment)	14
ECP.6.4 INTERIM OPERATIONAL NOTIFICATION (Network Operator's or Non-Embedded Customer's Plant and Apparatus)	1948
ECP.7. FINAL OPERATIONAL NOTIFICATION	21
ECP.8 LIMITED OPERATIONAL NOTIFICATION	25
ECP.9 PROCESSES RELATING TO DEROGATIONS.....	3130
ECP.10 MANUFACTURER'S DATA & PERFORMANCE REPORT	31
APPENDIX 1 34	
NOT USED 34	
APPENDIX 2 35	
USER SELF CERTIFICATION OF COMPLIANCE (Interim/Final)	35
APPENDIX 3 36	
SIMULATION STUDIES	36
APPENDIX 4 48	
ONSITE SIGNAL PROVISION FOR WITNESSING TESTS	48
APPENDIX 5 52	
COMPLIANCE TESTING OF SYNCHRONOUS POWER GENERATING MODULES ..	52
ECP.A.5.2 Excitation System Open Circuit Step Response Tests	53
ECP.A.5.3 Open & Short Circuit Saturation Characteristics	53
ECP.A.5.6 Over-excitation Limiter Performance Test	56
ECP.A.5.8 Governor and Load Controller Response Performance	58
ECP.A.5.9 Compliance with ECC.6.3.3 Functionality Test	62

EUROPEAN COMPLIANCE PROCESSES

ECP.1 INTRODUCTION

ECP.1.1 The **European Compliance Processes** ("ECP") specifies the compliance process in relation to directly connected and **Embedded Power Stations** (subject to a **Bilateral Agreement**), ~~and~~ **HVDC Systems, and Network Operator's or Non-Embedded Customer's Plant and Apparatus**. For the avoidance of doubt, the requirements of the European Compliance Processes do not apply to Demand Response Providers unless they are also an EU Code User and have entered into a CUSC Contract with NGET.

:

(i) Type A Power Generating Modules:

the process for issuing and receiving an **Installation Document** which must be followed by **NGET** and any **User** with a **Type A Power Generating Module** to demonstrate its compliance with the **Grid Code** in relation to its **Plant and Apparatus** prior to the relevant **Plant and Apparatus** being energised.

(ii) Type B, Type C or Type D Power Generating Modules and HVDC Systems:

the process (leading to an **Energisation Operational Notification**) which must be followed by **NGET** and any **User** with a **Type B, Type C or Type D Power Generating Module or HVDC System** to demonstrate its compliance with the **Grid Code** in relation to its **Plant and Apparatus** (including **OTSUA**) prior to the relevant **Plant and Apparatus** (including any **OTSUA**) being energised.

the process (leading to an **Interim Operational Notification** and **Final Operational Notification**) which must be followed by **NGET** and any **User** with a **Type B, Type C or Type D Power Generating Module or HVDC System** or **HVDC System Owner** to demonstrate its compliance with the **Grid Code** in relation to its **Plant and Apparatus** (including and dynamically controlled **OTSUA**). This process shall be followed prior to and during the course of the relevant **Plant and Apparatus** (including **OTSUA**) being energised and **Synchronised**.

the process (leading to a **Limited Operational Notification**) which must be followed by **NGET** and each **User** with a **Type B, Type C or Type D Power Generating Module or HVDC System** where any of its **Plant and/or Apparatus** (including any **OTSUA**) becomes unable to comply with relevant provisions of the **Grid Code**, and where applicable with Appendices F1 to F5 of the **Bilateral Agreement** (and in the case of **OTSUA** Appendices OF1 to OF5 of the **Bilateral Agreement**). This process also includes when changes or **Modifications** are made to **Plant and/or Apparatus**

Formatted: Font: Not Bold

Formatted: Font: Not Bold

Formatted: Font: Not Bold

Formatted: Font: Bold

Formatted: Font: Not Bold

Formatted: Font: Not Bold

Formatted: Font: Not Bold

(including **OTSUA**). This process applies to such **Plant** and/or **Apparatus** after the **Plant** and/or **Apparatus** has become **Operational** and until **Disconnected** from the **Total System**, (or until, in the case of **OTSUA**, the **OTSUA Transfer Time**) when changes or **Modifications** are made.

(iii) **Network Operator's or Non-Embedded Customer's Plant and Apparatus:**

the process (leading to an **Energisation Operational Notification**) which must be followed by **NGET** and any **Network Operator or Non-Embedded Customer** to demonstrate its compliance with the **Grid Code** in relation to its **Plant and Apparatus** prior to the relevant **Plant and Apparatus** being energised.

the process (leading to an **Interim Operational Notification and Final Operational Notification**) which must be followed by **NGET** and any **Network Operator or Non-Embedded Customer** to demonstrate its compliance with the **Grid Code** in relation to its **Plant and Apparatus**. This process shall be followed prior to and during the course of the relevant **Plant and Apparatus** being energised and operated by using the grid connection.

the process (leading to a **Limited Operational Notification**) which must be followed by **NGET** and each **Network Operator or Non-Embedded Customer** where any of its **Plant and/or Apparatus** becomes unable to comply with relevant provisions of the **Grid Code**, and where applicable with Appendices F1 to F5 of the **Bilateral Agreement**. This process also includes changes or **Modifications** made to the **Plant and/or Apparatus**. This process applies to such **Plant and/or Apparatus** after the **Plant and/or Apparatus** has become operational and until **Disconnected** from the **Transmission System**.

Formatted: Not Highlight

Formatted: Font: Not Bold

ECP.1.2 As used in the **ECP** references to **OTSUA** means **OTSUA** to be connected or connected to the **National Electricity Transmission System** prior to the **OTSUA Transfer Time**.

ECP.1.3 Where a **Generator** or **HVDC System Owner** and/or **NGET** are required to apply for a derogation to the **Authority**, this is not in respect of **OTSUA**.

ECP.2 OBJECTIVE

ECP.2.1 The objective of the **ECP** is to ensure that there is a clear and consistent process for demonstration of compliance by **EU Code Users** with the **European Connection Conditions** and **Bilateral Agreement** which are similar for all **EU Code Users** of an equivalent category and will enable **NGET** to comply with its statutory and **Transmission Licence** obligations. For the avoidance of doubt, the

requirements of the **European Compliance Processes** do not apply to **Demand Response Providers** unless they are also an **EU Code User** and have entered into a **CUSC Contract** with **NGET**.

Formatted: Font: Not Bold

ECP.2.2 Provisions of the **ECP** which apply in relation to **OTSDUW** and **OTSUA** shall (in any particular case) apply up to the **OTSUA Transfer Time**, whereupon such provisions shall (without prejudice to any prior non-compliance) cease to apply.

ECP.2.3 In relation to **OTSDUW**, provisions otherwise to be contained in a **Bilateral Agreement** may be contained in the **Construction Agreement**, and accordingly a reference in the **ECP** to a relevant **Bilateral Agreement** includes the relevant **Construction Agreement**.

ECP.3 **SCOPE**

ECP.3.1 The **ECP** applies to **NGET** and to **EU Code Users**, which in the **ECP** means:

(a) **EU Generators** (other than in relation to **Embedded Power Stations** not subject to a **Bilateral Agreement**) including those undertaking **OTSDUW**.

Formatted: Font: Bold

(b) **Network Operators** who are either:

Formatted: Not Highlight

(i) **EU Code Users** in respect of their **entire distribution System**; or

Formatted: Font: Bold, Not Highlight

(ii) **GB Code Users** in respect of their **EU Grid Supply Points only**

Formatted: List Paragraph, Numbered + Level: 1 + Numbering Style: i, ii, iii, ... + Start at: 1 + Alignment: Left + Aligned at: 4.19 cm + Indent at: 5.46 cm

(c) **Non-Embedded Customers** who are **EU Code Users**;

Formatted: Font: Not Bold

Formatted: Font: Not Bold

(d) **HVDC System Owners** (other than those which only have **Embedded HVDC Systems** not subject to a **Bilateral Agreement**).

Formatted: Font: Bold

ECP.3.2 The above categories of **EU Code User** will become bound by the **ECP** prior to them generating, distributing, supplying or consuming, or in the case of **OTSUA**, transmitting, as the case may be, and references to the various categories should, therefore, be taken as referring to them in that prospective role ~~as well as to **EU Code Users** actually connected.~~

Formatted: Font: Bold

Formatted: Font: Not Bold

Formatted: Font: Not Bold

Formatted: Font: Not Bold

Formatted: Font: Not Bold

Formatted: Font: Bold

Formatted: Font: Bold

Formatted: Font: Bold

Formatted: Font: Bold

Formatted: Justified, Indent: Left: 0.25 cm, Hanging: 2.5 cm

ECP.3.3 For the avoidance of doubt, **Demand Response Providers** do not need to satisfy the requirements of this **ECP** unless they are also defined as an **EU Code User**, and have a **CUSC Contract** with **NGET**. Where a **Demand Response Provider** is not an **EU Code User** and does not have a **CUSC Contract** with **NGET**, the requirements of the **Demand Response Services Code** shall only apply.

Formatted: Font: (Default) Arial, 11 pt

Formatted: Font: (Default) Arial, 11 pt

ECP.3.4 For the avoidance of doubt, this **ECP** does not apply to **GB Code Users** other than in respect of **Network Operator's EU Grid Supply Points**.

Formatted: Font: (Default) Arial, 11 pt, Not Bold

Formatted: Font: (Default) Arial, 11 pt

ECP.4 CONNECTION PROCESS

ECP.4.1 The **CUSC Contract(s)** contain certain provisions relating to the procedure for connection to the **National Electricity Transmission System** or, in the case of **Embedded Power Stations** or **Embedded HVDC Systems**, becoming operational and include provisions to be complied with by **EU Code Users** prior to and during the course of **NGET** notifying the **EU Code User** that it has the right to become operational. In addition to such provisions this **ECP** sets out in further detail the processes to be followed to demonstrate compliance. While this **ECP** does not expressly address the processes to be followed in the case **OTSUA** connecting to a **Network Operator's User System** prior to the **OTSUA Transfer Time**, the processes to be followed by **NGET** and the **Generator** in respect of **OTSUA** in such circumstances shall be consistent with those set out below by reference **OTSUA** directly connected to the **National Electricity Transmission System**.

ECP.4.2 The provisions contained in ECP.5 to ECP.7 detail the process to be followed in order for the **EU Code User's Plant and Apparatus** (including **OTSUA**) to become operational. This process includes:

- (i) the acceptance of an **Installation Document** for a **Type A Power Generating Module**;
- (ii) for energisation an **EON** for **Type B, Type C** or **Type D Power Generating Modules**, or **HVDC Equipment or Network Operator's or Non-Embedded Customer's Plant and Apparatus**;
- (iii) for synchronising an **ION** for **Type B, Type C** or **Type D Power Generating Modules** or **HVDC Equipment**;
- (iv) for operating by using the **Grid Supply Point** an **ION** for:
 - a. **Network Operators who are EU Code Users in respect of their entire distribution System**;
 - b. **Network Operators who are GB Code Users in respect of their EU Grid Supply Points only**; or
 - c. **Non-Embedded Customers who are EU Code Users**;
- (v) for final certification a **FON**.

ECP.4.2.1 The provisions contained in ECP.5 relate to the connection and energisation of **EU Code User's Plant and Apparatus** (including **OTSUA**) to the **National Electricity Transmission System** or where **Embedded**, to a **User's System**.

ECP.4.2.2 The provisions contained in ECP.6 and ECP.7 provide the process for **Generators and HVDC System Owners, Network Operators and Non-Embedded Customers** to demonstrate compliance with the **Grid Code** and with, where applicable, the **CUSC Contract(s)** prior to and during the course of such **Generator's or HVDC**

Formatted: Font: Not Bold

Formatted: Font: Not Bold

Formatted: Font: Not Bold

Formatted: Font: Not Bold

Formatted: Font: Bold

Formatted: Font: Bold

Formatted: Indent: Left: 1.27 cm, No bullets or numbering, Tab stops: Not at 2.76 cm + 4.03 cm + 4.83 cm + 6.35 cm + 8.13 cm + 10.41 cm

Formatted

Formatted: Font: Not Bold

Formatted: List Paragraph, Numbered + Level: 2 + Numbering Style: a, b, c, ... + Start at: 1 + Alignment: Left + Aligned at: 4.02 cm + Indent at: 4.66 cm, Tab stops: 4.03 cm, Left + 4.83 cm, Left + Not at 4.19 cm

Formatted: Font: Not Bold

Formatted: Font: Bold

System Owner's (including OTSUA up to the OTSUA Transfer Time), Network Operator's and Non-Embedded Customer's Plant and Apparatus (including OTSUA up to the OTSUA Transfer Time) becoming operational.

ECP.4.2.3 The provisions contained in ECP.8 detail the process to be followed when:

- (a) a **Generator's** or **HVDC System Owner's** or **Network Operator's or Non-Embedded Customer's Plant** and/or **Apparatus** (including the **OTSUA**) is unable to comply with any provisions of the **Grid Code** and **Bilateral Agreement**; or,
- (b) following any notification by a **Generator** or a **HVDC System Owner** or a **Network Operator** or a **Non-Embedded Customer** under the **PC** of any change to its **Plant** and/or **Apparatus** (including any **OTSUA**); or,
- (c) a **Modification** to a **Generator's** or a **HVDC System Owner's** or a **Network Operator's** or a **Non-Embedded Customer's** **Generator** or a **HVDC System Owner's** **Plant** and/or **Apparatus**.

Formatted: Font: Bold

Formatted: Font: Not Bold

Formatted: Font: Bold

ECP.4.3 Embedded Medium Power Stations not subject to a Bilateral Agreement and Embedded HVDC Equipment not subject to a Bilateral Agreement

ECP.4.3.1 In the case of **Embedded Medium Power Stations** not subject to a **Bilateral Agreement** and **Embedded HVDC Systems** not subject to a **Bilateral Agreement**, ensuring the obligations of the **ECC** and Appendix E of the relevant **Bilateral Agreement** between **NGET** and the host **Network Operator** are performed and discharged by the relevant party. For the avoidance of doubt the process in this **ECP** does not apply to **Embedded Medium Power Stations** not subject to a **Bilateral Agreement** and **Embedded HVDC Equipment** not subject to a **Bilateral Agreement**.

ECP.5 ENERGISATION OPERATIONAL NOTIFICATION

ECP.5.1 The following provisions apply in relation to the issue of an **Energisation Operational Notification** in respect of a **Power Station** consisting of **Type B**, **Type C** or **Type D Power Generating Modules**, or an **HVDC System** or a **Network Operator's** or a **Non-Embedded Customer's Plant and Apparatus**.

Formatted: Font: Not Bold

Formatted: Font: Not Bold

Formatted: Font: Not Bold

ECP.5.1.1 Certain provisions relating to the connection and energisation of the **EU Code-User's Plant** and **Apparatus** at the **Connection Site** and **OTSUA** at the **Transmission Interface Point** and in certain cases of **Embedded Plant** and **Apparatus** are specified in the **CUSC** and/or **CUSC Contract(s)**. For other **Embedded Plant** and **Apparatus** the **Distribution Code**, the **DCUSA** and the **Embedded Development Agreement** for the connection specify equivalent provisions. Further detail on this is set out in ECP.5 below.

Formatted: Font: Not Bold

ECP.5.2 The items for submission prior to the issue of an **Energisation Operational Notification** are set out in **ECC.5.2**.

ECP.5.3 In the case of a **Generator** or **HVDC System Owner** the items referred to in ECC.5.2 shall be submitted using the **Power Generating Module Document** or **User Data File Structure** as applicable.

Formatted: Font: Bold

ECP.5.4 Not less than 28 days, or such shorter period as may be acceptable in **NGET's** reasonable opinion, prior to the ~~EU Code~~ **User** wishing to energise its **Plant** and **Apparatus** (including passive **OTSUA**) for the first time, the ~~EU Code~~ **User** will submit to **NGET** a Certificate of Readiness to Energise **High Voltage e**Equipment which specifies the items of **Plant** and **Apparatus** (including **OTSUA**) ready to be energised in a form acceptable to **NGET**.

ECP.5.5 If the relevant obligations under the provisions of the **CUSC** and/or **CUSC Contract(s)** and the conditions of ECP.5 have been completed to **NGET's** reasonable satisfaction then **NGET** shall issue an **Energisation Operational Notification**. Any dynamically controlled reactive compensation **OTSUA** (including Statcoms or Static Var Compensators) shall not be **Energised** until the appropriate **Interim Operational Notification** has been issued in accordance with ECP.6.

ECP.6 OPERATIONAL NOTIFICATION PROCESSES

ECP.6.1 OPERATIONAL NOTIFICATION PROCESS (Type A)

ECP.6.1.1 The following provisions apply in relation to the notification process in respect of a **Power Station** consisting of **Type A Power Generating Modules**.

ECP.6.1.2 Not less than 7 days, or such shorter period as may be acceptable in **NGET's** reasonable opinion, prior to the **Generator** wishing to **Synchronise** its **Plant** and **Apparatus** for the first time the **Generator** will:

- (i) submit to **NGET** a **Notification of the User's Intention to Connect**; and
- (ii) submit to **NGET** an **Installation Document** containing at least but not limited to the items referred to at ECP.6.1.3.

ECP.6.1.3 Items for submission prior to connection.

ECP.6.1.3.1 Prior to the issue of an acknowledgment to connect the **Generator** must submit to **NGET** to **NGET's** satisfaction an **Installation Document** containing at least but not limited to:

- (i) The location at which the connection is made;
- (ii) The date of the connection;
- (iii) The maximum capacity of the installation in kW;

- (iv) The type of primary energy source;
- (v) The classification of the **Power Generating Module** as an emerging technology;
- (vi) A list of references to **Equipment Certificates** issued by an authorised certifier or otherwise agreed with **NGET** used for equipment that is installed at the site or copies of the relevant **Equipment Certificates** issued by an **Authorised Certifier** or otherwise where these are relied upon as part of the evidence of compliance;
- (vii) As regards equipment used, for which an **Equipment Certificate** has not been received, information shall be provided as directed by **NGET** or the **Relevant Network Operator**; and
- (viii) The contact details of the **Generator** and the installer and their signatures.

ECP.6.1.3.2 The items referred to in ECP.6.1.3 shall be submitted by the **Generator** in the form of an **Installation Document** for each applicable **Power Generating Module**.

ECP.6.1.4 No **Power Generating Module** shall be **Synchronised** to the **Total System** until the later of:

- (a) the date specified by the **Generator** in the **Installation Document** issued in respect of each applicable **Power Generating Module(s)**; and,
- (b) acknowledgement is received from **NGET** confirming receipt of the **Installation Document**.

ECP.6.1.5 When the requirements of ECP.6.1.2 to ECP.6.1.4 have been met, **NGET** will notify the **Generator** that the **Power Generating Module** may (subject to the **Generator** having fulfilled the requirements of ECP.6.1.3 where that applies) be **Synchronised** to the **Total System**.

ECP.6.1.6 Not less than 7 days, or such shorter period as may be acceptable in **NGET's** reasonable opinion, prior to the **Generator** wishing to decommission its **Plant** and **Apparatus** the **Generator** will submit to **NGET** a **Notification of User's Intention to Disconnect**.

ECP.6.2 **INTERIM OPERATIONAL NOTIFICATION (Type B and Type C)**

ECP.6.2.1 The following provisions apply in relation to the issue of a **Interim Operational Notification** in respect of a **Power Station** consisting of **Type B** and/or **Type C Power Generating Modules**.

ECP.6.2.2 Not less than 28 days, or such shorter period as may be acceptable in **NGET's** reasonable opinion, prior to the **Generator** wishing to **Synchronise** its **Plant** and **Apparatus** or dynamically controlled

OTSUA for the first time the **Generator or HVDC Equipment** owner will:

- (iii) submit to **NGET** a **Notification of User's Intention to Synchronise**; and
- (iv) submit to **NGET** an initial **Power Generating Module Document** containing at least but not limited to the items referred to at ECP.6.2.3.

ECP.6.2.3 Items for submission prior to issue of the **Interim Operational Notification**.

ECP.6.2.3.1 Prior to the issue of a **Interim Operational Notification** in respect of the **EU Code User's Plant and Apparatus** or dynamically controlled **OTSUA** the **Generator** must submit to **NGET** to **NGET's** satisfaction a **Interim Power Generating Module Document** containing at least but not limited to:

- (i) updated **Planning Code** data (both **Standard Planning Data** and **Detailed Planning Data**), with any estimated values assumed for planning purposes confirmed or, where practical, replaced by validated actual values and by updated estimates for the future and by updated forecasts for **Forecast Data** items such as **Demand**;
- (ii) for **Type C Power Generating Modules** the simulation models;
- (iii) details of any special **Power Generating Module(s)** protection as required by ECC.6.2.2.3 . This may include Pole Slipping protection and islanding protection schemes as applicable;
- (iv) simulation study provisions of Appendix ECP.A.3 and the results demonstrating compliance with **Grid Code** requirements of:

PC.A.5.4.2
PC.A.5.4.3.2,
ECC.6.3.4,
ECC.6.3.7.3.1 to ECC.6.3.7.3.6,
ECC.6.3.15, ECC.6.3.16
ECC.A.6.2.5.6
ECC.A.7.2.3.1

as applicable to the **Power Generating Module(s)** or dynamically controlled **OTSUA** unless agreed otherwise by **NGET**;

- (v) a detailed schedule of the tests and the procedures for the tests required to be carried out by the **Generator** under ECP.7.2 to demonstrate compliance with relevant **Grid Code** requirements. Such schedule to be consistent with

Formatted: Italian (Italy)

Appendix ECP.A.5 (in the case of a **Synchronous Power Generating Module**) or Appendix ECP.A.6 (in the case of a **Power Park Modules**) and **OTSUA** as applicable);

- (vi) copies of **Manufacturer's Test Certificates** or **Equipment Certificates** issued by an **Authorised Certifier** or equivalent as agreed with **NGET** where these are relied upon as part of the evidence of compliance and
- (vii) a **Compliance Statement** and a **User Self Certification of Compliance** completed by the **EU Code User** (including any **Unresolved Issues**) against the relevant **Grid Code** requirements including details of any requirements that the **Generator** has identified that will not or may not be met or demonstrated.

ECP.6.2.3.2 The items referred to in ECP.6.2.3 shall be submitted by the **Generator** in the form of a **Power Generating Module Document (PGMD)** for each applicable **Power Generating Module**.

ECP.6.2.4 No **Generating Unit** or dynamically controlled **OTSUA** shall be **Synchronised** to the **Total System** (and for the avoidance of doubt, dynamically controlled **OTSUA** will not be able to transmit) until the later of:

(a) the date specified by **NGET** in the **Interim Operational Notification** issued in respect of each applicable **Power Generating Module(s)** or dynamically controlled **OTSUA**; and,

(b) in the case of **Synchronous Power Generating Module(s)** only after the date of receipt by the **Generator** of written confirmation from **NGET** that the **Synchronous Power Generating Module** or **CCGT Module** as applicable has completed the following tests to demonstrate compliance with the relevant provisions of the **Connection Conditions** to **NGET's** satisfaction:

- (i) those tests required to establish the open and short circuit saturation characteristics of the **Synchronous Power Generating Module** (as detailed in Appendix ECP.A.4.3) to enable assessment of the short circuit ratio in accordance with ECC.6.3.2. Such tests may be carried out at a location other than the **Power Station** site and supplied in the form of an **Equipment Certificate** or as otherwise agreed by **NGET**; and
- (ii) open circuit step response tests (as detailed in Appendix ECP.A.5.2) to demonstrate compliance with ECC.A.6.2.4.1.

ECP.6.2.5 **NGET** shall assess the schedule of tests submitted by the **Generator** with the **Notification of User's Intention to Synchronise** under ECP.6.2.3 and shall determine whether such schedule has been completed to **NGET's** satisfaction.

ECP.6.2.6 When the requirements of ECP.6.2.2 to ECP.6.2.5 have been met, NGET will notify the Generator that the:
**Synchronous Power Generating Module,
CCGT Module,
Power Park Module or
Dynamically controlled OTSUA**

as applicable may (subject to the Generator having fulfilled the requirements of ECP.6.2.3 where that applies) be Synchronised to the Total System through the issue of an Interim Operational Notification. Where the Generator is undertaking OTSDUW then the Interim Operational Notification will be in two parts, with the "Interim Operational Notification Part A" applicable to OTSUA and the Interim Operational Notification Part B" applicable to the EU Code Users Plant and Apparatus. For the avoidance of doubt, the "Interim Operational Notification Part A" and the "Interim Operational Notification Part B" can be issued together or at different times. In respect of an Embedded Power Station or Embedded HVDC Equipment Station (other than a Embedded Medium Power Stations not subject to a Bilateral Agreement and Embedded HVDC Equipment Stations not subject to a Bilateral Agreement), NGET will notify the Network Operator that an Interim Operational Notification has been issued.

ECP.6.2.6.1 The Interim Operational Notification will be time limited, the expiration date being specified at the time of issue. The Interim Operational Notification may be renewed by NGET.

ECP.6.2.6.2 The Generator must operate the Power Generating Module or OTSUA in accordance with the terms, arising from the Unresolved Issues, of the Interim Operational Notification. Where practicable, NGET will discuss such terms with the Generator prior to including them in the Interim Operational Notification.

ECP.6.2.6.3 The Interim Operational Notification will include the following limitations:

- (a) In the case of OTSUA, the Interim Operational Notification Part A permits Synchronisation of the dynamically controlled OTSUA to the Total System only for the purposes of active control of voltage and reactive power and not for the purpose of exporting Active Power.
- (b) In the case of a Power Park Module the Interim Operational Notification (and where OTSDUW Arrangements apply, this reference will be to the Interim Operational Notification Part B) will limit the proportion of the Power Park Module which can be simultaneously Synchronised to the Total System such that neither of the following figures is exceeded:
 - (i) 20% of the Maximum Capacity of the Power Park Module (or the output of a single Power Park Unit where this exceeds 20% of the Power Station's Maximum Capacity)

until the **Generator** has completed the voltage control tests (detailed in ECP.A.6.2) (including in respect of any dynamically controlled **OTSUA**) to **NGET's** reasonable satisfaction. Following successful completion of this test each additional **Power Park Unit** should be included in the voltage control scheme as soon as is technically possible (unless **NGET** agrees otherwise).

(c) In the case of a **Synchronous Power Generating Module** employing a static **Excitation System** the **Interim Operational Notification** (and where **OTSDUW Arrangements** apply, this reference will be to the **Interim Operational Notification Part B**) may, if applicable, limit the maximum **Active Power** output and **Reactive Power** output of the **Synchronous Power Generating Module** or **CCGT module** prior to the successful commissioning of the **Power System Stabiliser** to **NGET's** satisfaction, if applicable.

ECP.6.2.6.4 Operation in accordance with the **Interim Operational Notification** whilst it is in force will meet the requirements for compliance by the **Generator** and **NGET** of all the relevant provisions of the **European Connection Conditions**.

ECP.6.2.7 Other than **Unresolved Issues** that are subject to tests required under ECP.7.2 to be witnessed by **NGET**, the **Generator** must resolve any **Unresolved Issues** prior to the commencement of the tests, unless **NGET** agrees to a later resolution. The **Generator** must liaise with **NGET** in respect of such resolution. The tests that may be witnessed by **NGET** are specified in ECP.7.2.

ECP.6.2.8 Not less than 28 days, or such shorter period as may be acceptable in **NGET's** reasonable opinion, prior to the **Generator** wishing to commence tests required under ECP.7 to be witnessed by **NGET**, the **Generator** will notify **NGET** that the **Power Generating Module(s)** as applicable is ready to commence such tests.

ECP.6.2.9 The items referred to at ECP.7.3 shall be submitted by the **Generator** after successful completion of the tests required under ECP.7.2.

ECP.6.3 INTERIM OPERATIONAL NOTIFICATION (Type D and HVDC Equipment)

ECP.6.3.1 The following provisions apply in relation to the issue of an **Interim Operational Notification** in respect of a **Power Station** consisting of **Type D Power Generating Modules** or an **HVDC System**.

ECP.6.3.2 Not less than 28 days, or such shorter period as may be acceptable in **NGET's** reasonable opinion, prior to the **Generator** or **HVDC System Owner** wishing to **Synchronise** its **Plant** and **Apparatus** or **dynamically controlled OTSUA** for the first time the **Generator** or **HVDC System Owner** will:

- i. submit to **NGET** a **Notification of User's Intention to Synchronise**; and
- ii. submit to **NGET** the items referred to at ECP.6.3.3.

ECP.6.3.3 Items for submission prior to issue of the **Interim Operational Notification**.

ECP.6.3.3.1 Prior to the issue of an **Interim Operational Notification** in respect of the **EU Code User's Plant and Apparatus** or dynamically controlled **OTSUA** the **Generator** or **HVDC System Owner** must submit to **NGET** to **NGET's** satisfaction:

- (a) updated **Planning Code** data (both **Standard Planning Data** and **Detailed Planning Data**), with any estimated values assumed for planning purposes confirmed or, where practical, replaced by validated actual values and by updated estimates for the future and by updated forecasts for **Forecast Data** items such as **Demand**;
- (b) details of any special **Power Generating Module(s)** or **HVDC Equipment** protection as applicable. This may include Pole Slipping protection and islanding protection schemes;
- (c) any items required by ECP.5.2, updated by the **EU Code User** as necessary;
- (d) simulation study provisions of Appendix ECP.A.3 and the results demonstrating compliance with **Grid Code** requirements of:

PC.A.5.4.2
PC.A.5.4.3.2,
ECC.6.3.4,
ECC.6.3.7.3.1 to ECC.6.3.7.3.6,
ECC.6.3.15, ECC.6.3.16
ECC.A.6.2.5.6
ECC.A.7.2.3.1

as applicable to the **Power Station, Synchronous Power Generating Module(s), Power Park Module(s), HVDC Equipment** or dynamically controlled **OTSUA** unless agreed otherwise by **NGET**;

- (e) a detailed schedule of the tests and the procedures for the tests required to be carried out by the **Generator** or **HVDC System Owner** under ECP.7.2 to demonstrate compliance with relevant **Grid Code** requirements. Such schedule to be consistent with Appendix ECP.A.5 (in the case of **Synchronous Power Generating Modules**) or Appendix ECP.A.6 (in the case of **Power Park** Modules and **OTSUA** as applicable) or Appendix ECP.A.7 (in the case of **HVDC Equipment**); and

Formatted: Italian (Italy)

- (f) an interim **Compliance Statement** and a **User Self Certification of Compliance** completed by the **EU Code User** (including any **Unresolved Issues**) against the relevant **Grid Code** requirements including details of any requirements that the **Generator** or **HVDC System Owner** has identified that will not or may not be met or demonstrated.

ECP.6.3.3.2 The items referred to in ECP.6.3.3 shall be submitted by the **Generator** or **HVDC System Owner** using the **User Data File Structure**.

ECP.6.3.4 No **Power Generating Module** or **HVDC Equipment** shall be **Synchronised** to the **Total System** (and for the avoidance of doubt, dynamically controlled **OTSUA** will not be able to transmit) until the later of:

- (a) the date specified by **NGET** in the **Interim Operational Notification** issued in respect of the **Power Generating Module(s)** or **HVDC Equipment** or dynamically controlled **OTSUA**; and,

- (b) if **Embedded**, the date of receipt of a confirmation from the **Network Operator** in whose **System** the **Plant and Apparatus** is connected that it is acceptable to the **Network Operator** that the **Plant and Apparatus** be connected and **Synchronised**; and,

- (c) in the case of **Synchronous Power Generating Module(s)** only after the date of receipt by **Generator** of written confirmation from **NGET** that the **Synchronous Power Generating Module** has completed the following tests to demonstrate compliance with the relevant provisions of the **Connection Conditions** to **NGET's** satisfaction:

- (i) those tests required to establish the open and short circuit saturation characteristics of the **Synchronous Power Generating Module** (as detailed in Appendix ECP.A.5.3) to enable assessment of the short circuit ratio in accordance with ECC.6.3.2. Such tests may be carried out at a location other than the **Power Station** site; and

- (ii) open circuit step response tests (as detailed in Appendix ECP.A.5.2) to demonstrate compliance with ECC.A.6.2.4.1.

ECP.6.3.5 **NGET** shall assess the schedule of tests submitted by the **Generator** or **HVDC System Owner** with the **Notification of User's Intention to Synchronise** under ECP.6.3.1 and shall determine whether such schedule has been completed to **NGET's** satisfaction.

ECP.6.3.6 When the requirements of ECP.6.3.2 to ECP.6.3.5 have been met, **NGET** will notify the **Generator** or **HVDC System Owner** that the: **Synchronous Power Generating Module, CCGT Module,**

Power Park Module
Dynamically controlled OTSUA or
HVDC Equipment,

as applicable may (subject to the **Generator** or **HVDC System Owner** having fulfilled the requirements of ECP.6.3.3 where that applies) be **Synchronised** to the **Total System** through the issue of an **Interim Operational Notification**. Where the **Generator** is undertaking **OTSDUW** then the **Interim Operational Notification** will be in two parts, with the "**Interim Operational Notification Part A**" applicable to OTSUA and the "**Interim Operational Notification Part B**" applicable to the **EU Code Users Plant and Apparatus**. For the avoidance of doubt, the "**Interim Operational Notification Part A**" and the "**Interim Operational Notification Part B**" can be issued together or at different times. In respect of an **Embedded Power Station** or **Embedded HVDC Equipment Station** (other than a **Embedded Medium Power Stations** not subject to a **Bilateral Agreement** and **Embedded HVDC Equipment Stations** not subject to a **Bilateral Agreement**), **NGET** will notify the **Network Operator** that an **Interim Operational Notification** has been issued.

ECP.6.3.6.1 The **Interim Operational Notification** will be time limited, the expiration date being specified at the time of issue. The **Interim Operational Notification** may be renewed by **NGET** for up to a maximum of 24 months from the date of the first issue of the **Interim Operational Notification**. **NGET** may only issue an extension to an **Interim Operational Notification** beyond 24 months provided the **Generator** or **HVDC System Owner** has applied for a derogation for any remaining **Unresolved Issues** to the **Authority** as detailed in ECP.9.

ECP.6.3.6.2 The **Generator** or **HVDC System Owner** must operate the **Power Generating Module** or **HVDC Equipment** in accordance with the terms, arising from the **Unresolved Issues**, of the **Interim Operational Notification**. Where practicable, **NGET** will discuss such terms with the **Generator** or **HVDC System Owner** prior to including them in the **Interim Operational Notification**.

ECP.6.3.6.3 The **Interim Operational Notification** will include the following limitations:

(a) In the case of **OTSUA**, the **Interim Operational Notification Part A** permits **Synchronisation** of the dynamically controlled **OTSUA** to the **Total System** only for the purposes of active control of voltage and reactive power and not for the purpose of exporting **Active Power**.

(b) In the case of a **Power Park Module** the **Interim Operational Notification** (and where **OTSDUW** Arrangements apply, this reference will be to the **Interim Operational Notification Part B**) will limit the proportion of the **Power Park Module** which can be simultaneously **Synchronised** to the **Total System** such that neither of the following figures is exceeded:

(i) 20% of the **Maximum Capacity** of the **Power Park Module** (or the output of a single **Power Park Unit**

where this exceeds 20% of the **Power Station's Maximum Capacity**); nor

(ii) 50MW

until the **Generator** has completed the voltage control tests (detailed in ECP.A.6.3.2) to **NGET's** reasonable satisfaction. Following successful completion of this test each additional **Power Park Unit** should be included in the voltage control scheme as soon as is technically possible (unless **NGET** agrees otherwise).

(c) In the case of a **Power Park Module** with a **Maximum Capacity** greater or equal to 100MW, the **Interim Operational Notification** (and where **OTSDUW** Arrangements apply, this reference will be to the **Interim Operational Notification Part B**) will limit the proportion of the **Power Park Module** which can be simultaneously **Synchronised** to the **Total System** to 70% of **Maximum Capacity** until the **Generator** has completed the **Limited Frequency Sensitive Mode (LFSM-O)** control tests with at least 50% of the **Maximum Capacity** of the **Power Park Module** in service (detailed in ECP.A.6.3.3) to **NGET's** reasonable satisfaction.

(d) In the case of a **Synchronous Power Generating Module** employing a static **Excitation System** or a **Power Park Module** employing a **Power System Stabiliser** the **Interim Operational Notification** (and where **OTSDUW** Arrangements apply, this reference will be to the Interim Operational Notification Part B) may if applicable limit the maximum **Active Power** output and **Reactive Power** output of the **Synchronous Power Generating Module** or **CCGT module** prior to the successful commissioning of the **Power System Stabiliser** to **NGET's** satisfaction.

ECP.6.3.6.4 Operation in accordance with the **Interim Operational Notification** whilst it is in force will meet the requirements for compliance by the **Generator** or **HVDC System Owner** and **NGET** of all the relevant provisions of the **European Connection Conditions**.

ECP.6.3.7 Other than **Unresolved Issues** that are subject to tests required under ECP.7.2 to be witnessed by **NGET**, the **Generator** or **HVDC System Owner** must resolve any **Unresolved Issues** prior to the commencement of the tests, unless **NGET** agrees to a later resolution. The **Generator** or **HVDC System Owner** must liaise with **NGET** in respect of such resolution. The tests that may be witnessed by **NGET** are specified in ECP.7.2.

ECP.6.3.8 Not less than 28 days, or such shorter period as may be acceptable in **NGET's** reasonable opinion, prior to the **Generator** or **HVDC System Owner** wishing to commence tests required under ECP.7 to be witnessed by **NGET**, the **Generator** or **HVDC System Owner** will notify **NGET** that the **Power Generating Module(s)** or **HVDC Equipment(s)** as applicable is ready to commence such tests.

ECP.6.3.9 The items referred to at ECP.7.3 shall be submitted by the **Generator** or the **HVDC System Owner** after successful completion of the tests required under ECP.7.2.

ECP.6.4 INTERIM OPERATIONAL NOTIFICATION (Network Operator's or Non-Embedded Customer's Plant and Apparatus)

Formatted: Font: Not Bold

ECP.6.4.1 The following provisions apply in relation to the issue of an **Interim Operational Notification** in respect of **Network Operator's or Non-Embedded Customer's Plant and Apparatus**.

ECP.6.4.2 Not less than 28 days, or such shorter period as may be acceptable in **NGET's** reasonable opinion, prior to the **Network Operator** or **Non-Embedded Customer** wishing to operate its **Plant and Apparatus** by using the **EU Grid Supply Point** for the first time, the **Network Operator** or **Non-Embedded Customer** will:

Formatted: Font: Not Bold

Formatted: Font: Bold

Formatted: Font: Bold

iii. submit to **NGET** a **Notification of User's Intention to Operate**; and

Formatted: Font: Bold, Not Highlight

Formatted: Not Highlight

iv. submit to **NGET** the items referred to at ECP.6.4.3.

ECP.6.4.3 Items for submission prior to issue of the **Interim Operational Notification**.

ECP.6.4.3.1 Prior to the issue of an **Interim Operational Notification** in respect of the **User's Plant and Apparatus** at an **EU Grid Supply Point**, the **Network Operator** or **Non-Embedded Customer** must submit to **NGET** to **NGET's** satisfaction:

Formatted: Font: Not Bold

Formatted: Font: Not Bold

(a) updated **Planning Code** data (both **Standard Planning Data** and **Detailed Planning Data**), with any estimated values assumed for planning purposes confirmed or, where practical, replaced by validated actual values and by updated estimates for the future and by updated forecasts for **Forecast Data** items such as **Demand**;

(b) details of any special protection as applicable;

Formatted: Not Highlight

(c) any items required by ECP.5.2, updated as necessary;

Formatted: Indent: Left: 2.75 cm, Hanging: 1.25 cm

(d) data submission and results required by Appendix ECP.A.8 demonstrating compliance with **Grid Code** requirements of:

PC.A.2.2
PC.A.2.3
PC.A.2.4
PC.A.2.5.2
PC.A.2.5.3
PC.A.2.5.4
PC.A.2.5.6
PC.A.4
PC.A.6.1.3
PC.A.6.3
PC.A.6.7.1

as applicable to the **Network Operator's or Non-Embedded Customer's Plant and Apparatus** unless agreed otherwise by **NGET**;

(e) a detailed schedule of the tests and the procedures for the tests required to be carried out by the **Network Operator or Non-Embedded Customer** under ECP.7.8 (or **Equipment Certificates** as relevant) to demonstrate compliance with relevant **Grid Code** requirements. Such schedule is to be consistent with Appendix ECP.A.8.

Formatted: Font: Bold

Formatted: Not Highlight

(f) an interim **Compliance Statement** and a **User Self Certification of Compliance** completed by the **User** (including any **Unresolved Issues**) against the relevant **Grid Code** requirements including details of any requirements that the **Network Operator or Non-Embedded Customer** has identified that will not or may not be met or demonstrated.

ECP.6.4.4 No **Network Operator's or Non-Embedded Customer's Plant and Apparatus** shall be operated by using the **EU Grid Supply Point** until the date specified by **NGET** in the **Interim Operational Notification**.

Formatted: Not Highlight

Formatted: Font: Bold

Formatted: Font: Bold

ECP.6.4.5 **NGET** shall assess the schedule of tests submitted by the **Network Operator or Non-Embedded Customer** with the **Notification of User's Intention to Operate** under ECP.6.4.1 and shall determine whether such schedule has been completed to **NGET's** satisfaction.

Formatted: Font: Bold, Not Highlight

ECP.6.4.6 When the requirements of ECP.6.4.2 to ECP.6.4.5 have been met, **NGET** will notify the **Network Operator or Non-Embedded Customer** that the **Plant and Apparatus** may (subject to the **Network Operator or Non-Embedded Customer** having fulfilled the requirements of ECP.6.4.3 where that applies) be operated by using the **EU Grid Supply Point** through the issue of an **Interim Operational Notification**.

Formatted: Not Highlight

Formatted: Font: Bold

Formatted: Font: Bold

ECP.6.4.6.1 The **Interim Operational Notification** will be time limited, the expiration date being specified at the time of issue. The **Interim Operational Notification** may be renewed by **NGET** for up to a maximum of 24 months from the date of the first issue of the **Interim Operational Notification**. **NGET** may only issue an extension to an **Interim Operational Notification** beyond 24 months provided the **Network Operator or Non-Embedded Customer** has applied for a derogation for any remaining **Unresolved Issues** to the **Authority** as detailed in ECP.9.

Formatted: Font: Not Bold

ECP.6.4.6.2 The **Network Operator or Non-Embedded Customer** must operate the **Plant and Apparatus** in accordance with the terms, arising from the **Unresolved Issues**, of the **Interim Operational Notification**. Where practicable, **NGET** will discuss such terms with the **Network Operator or Non-Embedded Customer** prior to including them in the **Interim Operational Notification**.

ECP.6.4.7 The **Network Operator** or **Non-Embedded Customer** must resolve any **Unresolved Issues** prior to the commencement of the tests, unless **NGET** agrees to a later resolution. The **Network Operator** or **Non-Embedded Customer** must liaise with **NGET** in respect of such resolution.

ECP.6.4.8 Not less than 28 days, or such shorter period as may be acceptable in **NGET's** reasonable opinion, prior to the **Network Operator** or **Non-Embedded Customer** wishing to commence tests required under ECP.7.8(e) and ECP.A.8, to be witnessed by **NGET** the **Network Operator** or **Non-Embedded Customer** will notify **NGET** that the **Network Operator** or **Non-Embedded Customer** as applicable is ready to commence such tests.

Formatted: Not Highlight

Formatted: Not Highlight

Formatted: Indent: Left: 0 cm, First line: 0 cm

ECP.7. FINAL OPERATIONAL NOTIFICATION

Final Operational Notification in respect of Generators and HVDC System Owners

Formatted: Not Highlight

ECP.7.1 The following provisions apply in relation to the issue of a **Final Operational Notification** in respect of a **Power Station** consisting of **Type B, Type C and Type D Power Generating Modules** or an **HVDC System**.

ECP.7.2 Tests to be carried out prior to issue of the **Final Operational Notification**.

ECP.7.2.1 Prior to the issue of a **Final Operational Notification** the **Generator** or **HVDC System Owner** must have completed the tests specified in this ECP.7.2.2 to **NGET's** satisfaction to demonstrate compliance with the relevant **Grid Code** provisions.

ECP.7.2.2 In the case of any **Power Generating Module, OTSUA** (if applicable) or **HVDC Equipment** these tests will reflect the relevant technical requirements and will comprise one or more of the following:

(a) Reactive capability tests to demonstrate that the **Power Generating Module, OTSUA** (if applicable) or **HVDC Equipment** can meet the requirements of ECC.6.3.2. These may be witnessed by **NGET** on site if there is no metering to the **NGET Control Centre**.

(b) voltage control system tests to demonstrate that the **Power Generating Module, OTSUA** (if applicable) or **HVDC Equipment** can meet the requirements of ECC.6.3.6.3, ECC.6.3.8 and, in the case of **Power Park Module, OTSUA** (if applicable) and **HVDC Equipment**, the requirements of ECC.A.7 or ECC.A.8 and, in the case of **Synchronous Power Generating Module** and **CCGT Module**, the requirements of ECC.A.6, and any terms specified in the **Bilateral Agreement** as applicable. These tests may also be used to validate the **Excitation System** model (PC.A.5.3) or

voltage control system model (PC.A.5.4) as applicable. These tests may be witnessed by **NGET**.

- (c) governor or frequency control system tests to demonstrate that the **Power Generating Module, OTSUA** (if applicable) or **HVDC Equipment** can meet the requirements of ECC.6.3.6.2, ECC.6.3.7, where applicable ECC.A.3, and BC.3.7. In the case of a **Type B Power Generating Module** only tests BC3 and BC4 in ECP.A.5.8 Figure 2 or ECP.A.6.6 Figure 2 must be completed. The results will also validate the **Mandatory Service Agreement** required by ECC.8.1. These tests may also be used to validate the governor model (PC.A.5.3) or frequency control system model (PC.A.5.4) as applicable. These tests may be witnessed by **NGET**.
- (d) fault ride through tests in respect of a **Power Station** with a **Maximum Capacity** of 100MW or greater, comprised of one or more **Power Park Modules**, to demonstrate compliance with ECC.6.3.15, ECC.6.3.16 and ECC.A.4. Where test results from a **Manufacturers Data & Performance Report** as defined in ECP.10 have been accepted this test will not be required.
- (e) any further tests reasonably required by **NGET** and agreed with the **EU Code User** to demonstrate any aspects of compliance with the **Grid Code** and the **CUSC Contracts**.

ECP.7.2.3 **NGET's** preferred range of tests to demonstrate compliance with the **ECCs** are specified in Appendix ECP.A.5 (in the case of **Synchronous Power Generating Modules**) or Appendix ECP.A.6 (in the case of a **Power Park Modules** or **OTSUA** (if applicable)) or Appendix ECP.A.7 (in the case of **HVDC Equipment** and are to be carried out by the **EU Code User** with the results of each test provided to **NGET**. The **EU Code User** may carry out an alternative range of tests if this is agreed with **NGET**. **NGET** may agree a reduced set of tests where there is a relevant **Manufacturers Data & Performance Report** as detailed in ECP.10 or an applicable **Equipment Certificate** has been accepted.

ECP.7.2.4 In the case of **Offshore Power Park Modules** which do not contribute to **Offshore Transmission Licensee Reactive Power** capability as described in ECC.6.3.2.5 or ECC.6.3.2.6 or Voltage Control as described in ECC.6.3.8.5 the tests outlined in ECP.7.2.2 (a) and ECP.7.2.2 (b) are not required. However, the offshore **Reactive Power** transfer tests outlined in ECP.A.5.8 shall be completed in their place.

ECP.7.2.5 Following completion of each of the tests specified in this ECP.7.2, **NGET** will notify the **Generator** or **HVDC System Owner** whether, in the opinion of **NGET**, the results demonstrate compliance with the relevant **Grid Code** conditions.

ECP.7.2.6 The **Generator** or **HVDC System Owner** is responsible for carrying out the tests and retains the responsibility for safety and personnel during the test.

ECP.7.3 Items for submission prior to issue of the **Final Operational Notification**

ECP.7.3.1 Prior to the issue of a **Final Operational Notification** the **Generator** or **HVDC System Owner** must submit to **NGET** to **NGET's** satisfaction:

- (a) updated **Planning Code** data (both **Standard Planning Data** and **Detailed Planning Data**), with validated actual values and updated estimates for the future including **Forecast Data** items such as **Demand**;
- (b) any items required by ECP.5.2 and ECP.6.2.3 or ECP.6.3.3 as applicable, updated by the **EU Code User** as necessary;
- (c) evidence to **NGET's** satisfaction that demonstrates that the controller models and/or parameters (as required under PC.A.5.3.2(c) option 2, PC.A.5.3.2(d) option 2, PC.A.5.4.2, and/or PC.A.5.4.3.2) supplied to **NGET** provide a reasonable representation of the behaviour of the **EU Code User's Plant and Apparatus** and **OTSUA** if applicable;
- (d) copies of **Manufacturer's Test Certificates** or **Equipment Certificates** issued by an **Authorised Certifier** or equivalent where these are relied upon as part of the evidence of compliance;
- (e) results from the tests required in accordance with ECP.7.2 carried out by the **Generator** to demonstrate compliance with relevant **Grid Code** requirements including the tests witnessed by **NGET**; and
- (f) the final **Compliance Statement** and a **User Self Certification of Compliance** signed by the **EU Code User** and a statement of any requirements that the **Generator** or **HVDC System Owner** has identified that have not been met together with a copy of the derogation in respect of the same from the **Authority**.

ECP.7.3.2 The items in ECP.7.3 should be submitted by the **Generator** (including in respect of any **OTSUA** if applicable) or **HVDC System Owner** using the **User Data File Structure**.

ECP.7.4 If the requirements of ECP.7.2 and ECP.7.3 have been successfully met, **NGET** will notify the **Generator** or **HVDC System Owner** that compliance with the relevant **Grid Code** provisions has been demonstrated for the **Power Generating Module(s)**, **OTSUA** if applicable or **HVDC Equipment** as applicable through the issue of a **Final Operational Notification**. In respect of an **Embedded Power Station** or **Embedded HVDC Equipment** other than an **Embedded Medium Power Station** not subject to a **Bilateral Agreement** and **Embedded HVDC Equipment** not subject to a **Bilateral Agreement**, **NGET** will notify the **Network Operator** that a **Final Operational Notification** has been issued.

ECP.7.5 If a **Final Operational Notification** cannot be issued because the requirements of ECP.7.2 and ECP.7.3 have not been successfully met prior to the expiry of an **Interim Operational Notification** then the **Generator** or **HVDC System Owner** (where licensed in respect of its activities) and/or **NGET** shall apply to the **Authority** for a derogation. The provisions of ECP.9 shall then apply.

Final Operational Notification in respect of Network Operator's and Non-Embedded Customer's Plant and Apparatus.

Formatted: Underline

ECP.7.6 The following provisions apply in relation to the issue of a **Final Operational Notification** in respect of **Network Operators and Non-Embedded Customers Plant and Apparatus.**

Formatted: Indent: Left: 0 cm, Hanging: 2.75 cm, Tab stops: 4.03 cm, Left + 4.83 cm, Left + Not at 4.19 cm

Formatted: Font: Not Bold

ECP.7.7 Prior to the issue of a **Final Operational Notification** the **Network Operator** and **Non-Embedded Customer** must have addressed the **Unresolved Issues** to **NGET's** satisfaction to demonstrate compliance with the relevant **Grid Code** provisions.

ECP.7.8 Prior to the issue of a **Final Operational Notification** the **Network Operator** and **Non-Embedded Customer** must submit to **NGET** to **NGET's** satisfaction:

(a) updated **Planning Code** data (both **Standard Planning Data** and **Detailed Planning Data**), with validated actual values and updated estimates for the future including **Forecast Data** items such as **Demand**;

(b) any items required by ECP.5.2 and ECP.6.4 updated by the **User** as necessary;

(c) evidence to **NGET's** reasonable satisfaction that demonstrates that the models and/or parameters as required under PC.A.2.2, PC.A.2.3, PC.A.2.4, PC.A.2.5, PC.A.4 and PC.A.6 (as applicable), supplied to **NGET** provide a reasonable representation of the behaviour of the **User's Plant and Apparatus**;

Formatted: Font: Bold

(d) copies of **Manufacturer's Test Certificates** or **Equipment Certificates** issued by an **Authorised Certifier** or equivalent where these are relied upon as part of the evidence of compliance;

(e) results from the tests and simulations required in accordance with ECP.A.8 carried out by the **Network Operator** or **Non-Embedded Customer** to demonstrate compliance with relevant **Grid Code** requirements including any tests witnessed by **NGET**; and

Formatted: Not Highlight

(f) the final **Compliance Statement** and a **User Self Certification of Compliance** signed by the **User** and a statement of any requirements that the **Network Operator** or

Formatted: Font: Not Bold

Non-Embedded Customer has identified that have not been met together with a copy of the derogation in respect of the same from the Authority.

ECP.7.9 The items referred to at ECP.7.8 shall be submitted by the Network Operator or Non-Embedded Customer after successful completion of the tests required under ECP.7.8.

Formatted: Indent: Left: 0 cm, Hanging: 2.75 cm, Space Before: 0 pt, Tab stops: 2.76 cm, Left

ECP.7.10 If the requirements of ECP.7.8 have been successfully met, NGET will notify the Network Operator or Non-Embedded Customer that compliance with the relevant Grid Code provisions has been demonstrated for Network Operators or Non-Embedded Customers Plant and Apparatus as applicable through the issue of a Final Operational Notification.

ECP.7.11 If a Final Operational Notification cannot be issued because the requirements of ECP.7.8 have not been successfully met prior to the expiry of an Interim Operational Notification, then the Network Operator or Non-Embedded Customer and/or NGET shall apply to the Authority for a derogation. The provisions of ECP.9 shall then apply.

Formatted: Font: Not Bold

ECP.8 LIMITED OPERATIONAL NOTIFICATION

ECP.8.1 Following the issue of a Final Operational Notification for a Power Station consisting of Type B, Type C or Type D Power Generating Module or an HVDC System or Network Operators or Non-Embedded Customers Plant and Apparatus, if:

(i) the Generator or HVDC System Owner or Network Operator or Non-Embedded Customer becomes aware, that its Plant and/or Apparatus (including OTSUA if applicable) capability to meet any provisions of the Grid Code, or where applicable the Bilateral Agreement is not fully available, then the Generator or HVDC System Owner or Network Operator or Non-Embedded Customer shall follow the process in ECP.8.2 to ECP.8.11; or,

Formatted: Font: Not Bold

(ii) a Network Operator becomes aware, that the capability of Plant and/or Apparatus belonging to a Embedded Power Station or Embedded HVDC Equipment Station (other than a Embedded Medium Power Stations not subject to a Bilateral Agreement and Embedded HVDC Equipment Stations not subject to a Bilateral Agreement) is failing to meet any provisions of the Grid Code, or where applicable the Bilateral Agreement then the Network Operator shall inform NGET and NGET shall inform the Generator or HVDC System Owner and then follow the process in ECP.8.2 to ECP.8.11; or,

Formatted: Indent: Left: 0 cm, First line: 0 cm

(iii) NGET becomes aware through monitoring as described in OC5.4, that a Generator or HVDC System Owner Plant and/or Apparatus (including OTSUA if applicable) capability to

Formatted: Indent: Left: 2.75 cm, Hanging: 1 cm, Tab stops: 3.75 cm, List tab + Not at 4.83 cm + 5.02 cm

meet any provisions of the **Grid Code**, or where applicable the **Bilateral Agreement** is not fully available then **NGET** shall inform the other party. Where **NGET** and the **Generator** or **HVDC System Owner** cannot agree from the monitoring as described in OC5.4 whether the **Plant and/or Apparatus** (including **OTSUA** if applicable) is fully available and/or is compliant with the requirements of the **Grid Code** and where applicable the **Bilateral Agreement**, the parties shall first apply the process in OC5.5.1, before applying the process defined in ECP.8 (**LON**) if applicable. Where the testing instructed in accordance with OC.5.5.1 indicates that the **Plant and/or Apparatus** (including **OTSUA** if applicable) is not fully available and/or is not compliant with the requirements of the **Grid Code** and/or the **Bilateral Agreement**, or if the parties so agree, the process in ECP.8.2 to ECP.8.11 shall be followed.

(iv) ~~NGET becomes aware that a Network Operator's or Non-Embedded Customer's Plant and Apparatus capability to meet any provisions of the Grid Code, or where applicable the Bilateral Agreement, is not fully available then NGET shall inform the other party and the process in ECP.8.2 to ECP.8.11 shall be followed.~~

Formatted: Indent: Left: 2.5 cm, Hanging: 1.25 cm, Tab stops: 3.75 cm, List tab + Not at 4.83 cm + 5.02 cm

Formatted: Font: Not Bold

Formatted: Font: Not Bold

ECP.8.2 Immediately upon a ~~Generator or HVDC System Owner, Network Operator or Non-Embedded Customer~~ becoming aware that its ~~Power Generating Module, OTSUA (if applicable), or HVDC Equipment or Plant and Apparatus,~~ as applicable, may be unable to comply with certain provisions of the **Grid Code** or (where applicable) the **Bilateral Agreement**, the ~~Generator or HVDC System Owner Network Operator or Non-Embedded Customer~~ shall notify **NGET** in writing. Additional details of any operating restrictions or changes in applicable data arising from the potential non-compliance and an indication of the date from when the restrictions will be removed and full compliance demonstrated shall be provided as soon as reasonably practical.

Formatted: Font: Not Bold

Formatted: Font: Not Bold

ECP.8.3 If the nature of any unavailability and/or potential non-compliance described in ECP.8.1 causes or can reasonably be expected to cause a material adverse effect on the business or condition of **NGET** or other ~~EU Code Users~~ or the **National Electricity Transmission System** or any ~~EU Code User Systems,~~ then **NGET** may, notwithstanding the provisions of this ECP.8, follow the provisions of Paragraph 5.4 of the **CUSC**.

Formatted: Font: Not Bold

ECP.8.4 Except where the provisions of ECP.8.3 apply, where the restriction notified in ECP.8.2 is not resolved in 28 days, then

(i) the **Generator** or **HVDC System Owner** with input from and discussion of conclusions with **NGET**, and the **Network Operator** where the **Synchronous Power Generating Module, CCGT Module, Power Park Module** or **Power Station** as applicable is **Embedded**, shall undertake an investigation to attempt to determine the causes of and determine a solution to the non-compliance. Such

Formatted: List Paragraph, Numbered + Level: 1 + Numbering Style: i, ii, iii, ... + Start at: 1 + Alignment: Left + Aligned at: 2.51 cm + Indent at: 3.78 cm

Formatted: Font: Not Bold

investigation shall continue for no longer than 56 days. During such an investigation, the **Generator or HVDC System Owner** shall provide to **NETG** the relevant data which has changed due to the restriction in respect of ECP.7.3.1 as notified to the **Generator or HVDC System Owner** ~~Generator or HVDC System Owner~~ by **NETG** as being required to be provided; or

(ii) the **Network Operator or Non-Embedded Customer** in discussion with **NETG**, shall undertake an investigation to attempt to determine the causes of and a solution to the non-compliance. Such investigation shall continue for no longer than 56 days. During such investigation the **Network Operator or Non-Embedded Customer** shall provide to **NETG** the relevant data which has changed due to the restriction in respect of ECP.7.8 as being required to be provided by **NETG**.

Formatted: List Paragraph, Indent: Left: 3.78 cm, First line: 0 cm

Formatted: Font: Not Bold

Formatted: List Paragraph, Numbered + Level: 1 + Numbering Style: i, ii, iii, ... + Start at: 1 + Alignment: Left + Aligned at: 2.51 cm + Indent at: 3.78 cm

Formatted: Font: Bold

Formatted: Indent: Left: 0 cm, First line: 0 cm

ECP.8.5 Issue and Effect of LON

ECP.8.5.1 Following the issue of a **Final Operational Notification**, **NETG** will issue to the **Generator, HVDC System Owner, Network Operator or Non-Embedded Customer** ~~Generator or HVDC System Owner~~ a **Limited Operational Notification** if:

- (a) by the end of the 56 day period referred to at ECP.8.4, the investigation has not resolved the non-compliance to **NETG's** satisfaction; or
- (b) **NETG** is notified by a **Generator, HVDC System Owner (including OTSUA if applicable), Network Operator or Non-Embedded Customer** ~~Generator or HVDC Equipment System Owner~~ of a **Modification** to its **Plant and Apparatus** ~~(including OTSUA if applicable)~~; or
- (c) **NETG** receives a submission of data, or a statement from a **Generator, HVDC System Owner (including OTSUA if applicable), Network Operator or Non-Embedded Customer** ~~Generator or HVDC System Owner~~ indicating a change in **Plant or Apparatus** ~~(including OTSUA if applicable)~~ or settings (including but not limited to governor and excitation control systems) that may in **NETG's** reasonable opinion, acting in accordance with **Good Industry Practice** be expected to result in a material change of performance.

Formatted: Font: Not Bold

Formatted: Font: Not Bold

In the case of an **Embedded Generator** or **Embedded HVDC System Owner**, **NETG** will issue a copy of the **Limited Operational Notification** to the **Network Operator**.

ECP.8.5.2 The **Limited Operational Notification** will be time limited (in the case of **Type D, or HVDC Systems, Network Operator's or Non-Embedded Customer's Plant and Apparatus**) to expire no later than 12 months from the start of the non-compliance or restriction or from reconnection following a change). **NETG** may agree a longer duration in the case of a **Limited Operational Notification** following a

Formatted: Font: Not Bold

Modification or whilst the **Authority** is considering the application for a derogation in accordance with ECP.9.1.

ECP.8.5.3 The **Limited Operational Notification** will notify the Generator, HVDC System Owner, Network Operator or Non-Embedded Customer of any restrictions on the operation of the **Synchronous Power Generating Module(s), CCGT Module(s), Power Park Module(s)**, ~~OTSUA~~ if applicable, ~~or HVDC Equipment or Plant and Apparatus~~ and will specify the **Unresolved Issues**. The Generator, HVDC System Owner, Network Operator or Non-Embedded Customer ~~Generator or HVDC System Owner~~ must operate in accordance with any notified restrictions and must resolve the **Unresolved Issues**.

Formatted: Font: Not Bold

Formatted: Font: Not Bold

ECP.8.5.4 The ~~EU Code-User~~ and **NGET** will be deemed compliant with all the relevant provisions of the **Grid Code** provided operation is in accordance with the **Limited Operational Notification**, whilst it is in force, and that the provisions of and referred to in ECP.8 are complied with.

ECP.8.5.5 The **Unresolved Issues** included in a **Limited Operational Notification** will show the extent that the provisions of ECP.7.2 (testing) and ECP.7.3 (final data submission) or ECP.7.8 (d) - (e) (testing) and ECP.7.8 (a) - (c) (data submission), as applicable, shall apply. In respect of selecting the extent of any tests which may in **NGET's** view reasonably be needed to demonstrate the restored capability and in agreeing the time period in which the tests will be scheduled, **NGET** shall, where reasonably practicable, take account of the Generator, HVDC System Owner, Network Operator or Non-Embedded Customers ~~Generator or HVDC System Owner's~~ input to contain its costs associated with the testing.

Formatted: Font: Not Bold

ECP.8.5.6 In the case of a change or **Modification**, the **Limited Operational Notification** may specify that the affected ~~Plant~~ and ~~or Apparatus~~ (including **OTSUA** if applicable) or associated **Synchronous Power Generating Module(s)** or **Power Park Unit(s)** must not be Synchronised or, in the case of ~~Network Operator's or Non-Embedded Customer's Plant and Apparatus~~, operated until all of the following items, that in **NGET's** reasonable opinion are relevant, have been submitted to **NGET** to **NGET's** satisfaction:

Formatted: Font: Not Bold

Formatted: Not Highlight

Formatted: Not Highlight

Formatted: Not Highlight

Formatted: Font: Not Bold, Not Highlight

Formatted: Not Highlight

Formatted: Font: Not Bold, Not Highlight

Formatted: Font: Not Bold

(a) updated **Planning Code** data (both **Standard Planning Data** and **Detailed Planning Data**);

(b) details of any relevant special **Power Station, Synchronous Power Generating Module(s), Power Park Module(s), OTSUA** (if applicable), ~~or HVDC Equipment Station(s)~~ or Network Operator's or Non-Embedded Customer's Plant and Apparatus protection as applicable. This may include Pole Slipping protection and islanding protection schemes; and

Formatted: Not Highlight

Formatted: Not Highlight

Formatted: Not Highlight

(c) simulation study provisions of Appendix ECP.A.3 or Appendix ECP.A.8 as appropriate and the results demonstrating

compliance with **Grid Code** requirements relevant to the change or **Modification** as agreed by **NGET**; and

- ~~(e)~~(d) ~~(d)~~—a detailed schedule of the tests and the procedures for the tests required to be carried out by the **Generator**, ~~or HVDC Equipment Station~~, **Network Operator** or **Non-Embedded Customer** to demonstrate compliance with relevant **Grid Code** requirements as agreed by **NGET**. The schedule of tests shall be consistent with Appendix ECP.A.5, ~~or Appendix ECP.A.6~~ or **Appendix ECP.A.8** as appropriate; and
- (e) an interim **Compliance Statement** and a **User Self Certification of Compliance** completed by the **User** (including any **Unresolved Issues**) against the relevant **Grid Code** requirements including details of any requirements that the **Generator**, ~~or HVDC System Owner~~, **Network Operator** or **Non-Embedded Customer** has identified that will not or may not be met or demonstrated; and
- (f) any other items specified in the **LON**.

ECP.8.5.7 The items referred to in ECP.8.5.6 shall be submitted by the **Generator** (including in respect of any **OTSUA** if applicable) or **HVDC System Owner** using the **User Data File Structure** or **Power Generation Module Document** as applicable.

ECP.8.5.8 In the case of **Synchronous Power Generating Module(s)** only, the **Unresolved Issues** of the **LON** may require that the **Generator** must complete the following tests to **NGET's** satisfaction to demonstrate compliance with the relevant provisions of the **CCs** prior to the **Synchronous Power Generating Module** being **Synchronised to the Total System**:

- (a) those tests required to establish the open and short circuit saturation characteristics of the **Synchronous Power Generating Module** (as detailed in Appendix ECP.A.5.3) to enable assessment of the short circuit ratio in accordance with ECC.6.3.2.3.4 or ECC.6.3.2.5. Such tests may be carried out at a location other than the **Power Station** site; and
- (b) open circuit step response tests (as detailed in Appendix ECP.A.5.2) to demonstrate compliance with ECC.A.6.2.4.1.

ECP.8.6 In the case of a change or **Modification**, not less than 28 days, or such shorter period as may be acceptable in **NGET's** reasonable opinion:

- (a) ~~p~~ prior to the **Generator** or **HVDC System Owner** (including **OTSUA** if applicable) ~~wishing to Synchronise its Plant and Apparatus for the first time following the change or Modification,~~ **the Generator or HVDC System Owner will**;

Formatted: Font: Not Bold

Formatted: Highlight

Formatted: Highlight

Formatted: Font: Not Bold

Formatted: List Paragraph, Numbered + Level: 1 + Numbering Style: a, b, c, ... + Start at: 1 + Alignment: Left + Aligned at: 2.54 cm + Indent at: 3.17 cm

Formatted: Font: Not Bold

Formatted: Indent: Left: 3.17 cm, First line: 0 cm

(i) submit a Notification of User's Intention to Synchronise:
and

Formatted: Indent: Left: 3.17 cm, Hanging: 0.83 cm

(ii) submit to NGET the items referred to at ECP.8.5.6.

Formatted: Indent: Left: 4.44 cm, No bullets or numbering

Formatted: Indent: Left: 3.17 cm, Hanging: 0.83 cm

Formatted: Normal, No bullets or numbering

Formatted: Indent: Left: 0 cm, First line: 0 cm

(b) prior to the Network Operator or Non-Embedded Customer
wishing to operate its Plant and Apparatus for the first time
following the change or Modification, its Plant and Apparatus
(including OTSUA if applicable) for the first time following the
change or Modification, the Generator or HVDC System Owner
the Network Operator or Non-Embedded Customer will:

Formatted: List Paragraph, Numbered + Level: 1 +
Numbering Style: a, b, c, ... + Start at: 1 + Alignment: Left +
Aligned at: 2.54 cm + Indent at: 3.17 cm

Formatted: Not Highlight

Formatted: Font: Not Bold

:

(i) submit a Notification of User's Intention to
OSynchroniseoperate; and

Formatted: Not Highlight

(ii) submit to NGET the items referred to at ECP.8.5.6.

ECP.8.7

Other than **Unresolved Issues** that are subject to tests to be witnessed by NGET, the **Generator, HVDC System Owner, Network Operator or Non-Embedded Customer Generator or HVDC System Owner** must resolve any **Unresolved Issues** prior to the commencement of the tests, unless NGET agrees to a later resolution. The **Generator, HVDC System Owner, Network Operator or Non-Embedded Customer Generator or HVDC System Owner** must liaise with NGET in respect of such resolution. The tests that may be witnessed by NGET are specified in ECP.7.2.2.

Formatted: Font: Not Bold

Formatted: Font: Not Bold

Formatted: Font: Not Bold

Formatted: Font: Not Bold

ECP.8.8

Not less than 28 days, or such shorter period as may be acceptable in NGET's reasonable opinion, prior to the **Generator or HVDC System Owner** wishing to commence tests listed as **Unresolved Issues** to be witnessed by NGET, the **Generator or HVDC System Owner** will notify NGET that the **Synchronous Power Generating Module(s), CCGT Module(s), Power Park Module(s), OTSUA** if applicable or **HVDC Equipment** as applicable is ready to commence such tests.

ECP.8.9

The items referred to at ECP.7.3 or ECP.7.8 as applicable and listed as **Unresolved Issues** shall be submitted by the **Generator, HVDC System Owner, Network Operator or Non-Embedded Customer Generator or the HVDC System Owner** after successful completion of the tests.

Formatted: Font: Not Bold

Formatted: Font: Not Bold

ECP.8.10

Where the **Unresolved Issues** have been resolved a **Final Operational Notification** will be issued to the **EU Code-User**.

ECP.8.11

If a **Final Operational Notification** has not been issued by NGET as referred to at ECP.8.5.2 (or where agreed following a **Modification** by the expiry time of the **LON**) then the **Generator, HVDC System Owner, Network Operator or Non-Embedded Customer Generator or HVDC System Owner** (where licensed in respect of its activities) and NGET shall apply to the **Authority** for a derogation.

Formatted: Font: Not Bold

Formatted: Font: Not Bold

ECP.9 PROCESSES RELATING TO DEROGATIONS

ECP.9.1 Whilst the **Authority** is considering the application for a derogation, the **Interim Operational Notification** or **Limited Operational Notification** will be extended to remain in force until the **Authority** has notified **NGET** and the ~~**Generator, HVDC System Owner, Network Operator or Non-Embedded Customer Generator or HVDC System Owner**~~ of its decision. Where the **Generator** or **HVDC System Owner** is not licensed, **NGET** may propose any necessary changes to the **Bilateral Agreement** with such unlicensed **Generator** or **HVDC System Owner**.

Formatted: Font: Not Bold

Formatted: Font: Not Bold

ECP.9.2 If the **Authority**:

- (a) grants a derogation in respect of the **Plant** and/or **Apparatus**, then **NGET** shall issue **Final Operational Notification** once all other **Unresolved Issues** are resolved; or
- (b) decides a derogation is not required in respect of the **Plant** and/or **Apparatus** then **NGET** will reconsider the relevant **Unresolved Issues** and may issue a **Final Operational Notification** once all other **Unresolved Issues** are resolved; or
- (c) decides not to grant any derogation in respect of the **Plant** and/or **Apparatus**, then there will be no **Operational Notification** in place and **NGET** and the ~~**EU Code User**~~ shall consider its rights pursuant to the **CUSC**.

ECP.9.3 Where a **Interim Operational Notification** or **Limited Operational Notification** is so conditional upon a derogation and such derogation includes any conditions (including any time limit to such derogation) the ~~**Generator, HVDC System Owner, Network Operator or Non-Embedded Customer Generator or HVDC System Owner**~~ will progress the resolution of any **Unresolved Issues** and / or progress and / or comply with any conditions upon such derogation and the provisions of ECP.6.9 to ECP.7.11 shall apply and shall be followed.

Formatted: Font: Not Bold

Formatted: Font: Not Bold

ECP.10 MANUFACTURER'S DATA & PERFORMANCE REPORT

Formatted: Highlight

ECP.10.1.1 Data and performance characteristics in respect of certain **Grid Code** requirements may be registered with **NGET** by **Power Park Unit** manufacturers in respect of specific models of **Power Park Units** by submitting information in the form of a **Manufacturer's Data and Performance Report to NGET**.

ECP.10.1.2 A **Generator** planning to construct a new **Power Station** containing the appropriate version of **Power Park Units** in respect of which a **Manufacturer's Data & Performance Report** has been submitted to **NGET** may reference the **Manufacturer's Data & Performance Report** in its submissions to **NGET**. Any **Generator** considering referring to a **Manufacturer's Data & Performance Report** for any aspect of its **Plant** and **Apparatus** may contact **NGET** to discuss the suitability of the relevant **Manufacturer's Data & Performance Report** to its project to determine if, and to what extent, the data included in the **Manufacturer's Data & Performance Report**

contributes towards demonstrating compliance with those aspects of the **Grid Code** applicable to the **Generator**. **NGET** will inform the **Generator** if the reference to the **Manufacturer's Data & Performance Report** is not appropriate or not sufficient for its project.

ECP.10.1.3 The process to be followed by **Power Park Unit** manufacturers submitting a **Manufacturer's Data & Performance Report** is agreed by **NGET**. **ECP.10.2** indicates the specific **Grid Code** requirement areas in respect of which a **Manufacturer's Data & Performance Report** may be submitted.

ECP.10.1.4 **NGET** will maintain and publish a register of those **Manufacturer's Data & Performance Reports** which **NGET** has received and accepted as being an accurate representation of the performance of the relevant **Plant** and / or **Apparatus**. Such register will identify the manufacturer, the model(s) of **Power Park Unit(s)** to which the report applies and the provisions of the **Grid Code** in respect of which the report contributes towards the demonstration of compliance. The inclusion of any report in the register does not in any way confirm that any **Power Park Modules** which utilise any **Power Park Unit(s)** covered by a report is or will be compliant with the **Grid Code**.

ECP.10.2 A **Manufacturer's Data & Performance Report** in respect of **Power Park Units** may cover one (or part of one) or more of the following provisions of the **Grid Code**:

- (a) Fault Ride Through capability **ECC.6.3.15**, **ECC.6.3.16**.
- (b) Power Park Module mathematical model **PC.A.5.4.2**.

ECP.10.3 Reference to a **Manufacturer's Data & Performance Report** in a **EU Code User's** submissions does not by itself constitute compliance with the **Grid Code**.

ECP.10.4 A **Generator** referencing a **Manufacturer's Data & Performance Report** should insert the relevant **Manufacturer's Data & Performance Report** reference in the appropriate place in the **DRC** data submission, **Power Generating Module Document** and / or in the **User Data File Structure**. **NGET** will consider the suitability of a **Manufacturer's Data & Performance Report**:

- (a) in place of **DRC** data submissions a mathematical model suitable for representation of the entire **Power Park Module** as per **ECP.A.3.4.4**. For the avoidance of doubt only the relevant sections as specified in **PC.A.2.5.5.7** apply. Site specific parameters will still need to be submitted by the **Generator**.
- (b) in place of Fault simulation studies as follows:

NGET will not require Fault Ride Through simulation studies to be conducted as per **ECP.A.3.5.1** and qualified in **ECP.A.3.5.2** provided that;

(i) Adequate and relevant **Power Park Unit** data is included in respect of Fault Ride Through testing covered in ECP.A.6.7 in the relevant **Manufacturer's Data & Performance Report** , and

(ii) For each type and duration of fault as detailed in ECP.A.3.5.1, the expected minimum retained voltage is greater than the corresponding minimum voltage achieved and successfully ridden through in the fault ride through tests covered by the **Manufacturer's Data & Performance Report**.

(c) to reduce the scope of compliance site tests as follows:

(i) Where there is a **Manufacturer's Data & Performance Report** in respect of a **Power Park Unit** which covers Fault Ride Through, **NGET** may agree that no Fault Ride Through testing is required.

ECP.10.5 It is the responsibility of the **EU Code User** to ensure that the correct reference for the **Manufacturer's Data & Performance Report** is used and the **EU Code User** by using that reference accepts responsibility for the accuracy of the information. The **EU Code User** shall ensure that the manufacturer has kept **NGET** informed of any relevant variations in plant specification since the submission of the relevant **Manufacturer's Data & Performance Report** which could impact on the validity of the information.

ECP.10.6 **NGET** may contact the **Power Park Unit** manufacturer directly to verify the relevance of the use of such **Manufacturer's Data & Performance Report**. If **NGET** believe the use some or all of such **Manufacturer's Data & Performance Report** information is incorrect or the referenced data is inappropriate then the reference to the **Manufacturer's Data & Performance Report** may be declared invalid by **NGET**. Where, and to the extent possible, the data included in the **Manufacturer's Data & Performance Report** is appropriate, the compliance assessment process will be continued using the data included in the **Manufacturer's Data & Performance Report**.

APPENDIX 1
NOT USED

DRAFT

APPENDIX 2

USER SELF CERTIFICATION OF COMPLIANCE (Interim/Final)

Power Station/ HVDC Equipment Station	[Name of Connection Site/site of connection]	User:	[Full User name]	Maximum Capacity (MW) of Plant:	
--	---	--------------	------------------	--	--

This **User Self Certification of Compliance** records the compliance by the **EU Code User** in respect of [NAME] **Power Station/HVDC Equipment Station** with the **Grid Code** and the requirements of the **Bilateral Agreement** and **Construction Agreement** dated [] with reference number []. It is completed by the **Power Station/HVDC System Owner** in the case of **Plant** and/or **Apparatus** connected to the **National Electricity Transmission System** and for **Embedded Plant**.

We have recorded our compliance against each requirement of the **Grid Code** which applies to the **Power Station/HVDC Equipment Station**, together with references to supporting evidence and a commentary where this is appropriate, and have provided this to **NET**. A copy of the **Compliance Statement** is attached.

Supporting evidence, in the form of simulation results, test results, manufacturer's data and other documentation, is attached in the **User Data File Structure**.

The **EU Code User** hereby certifies that, to the best of its knowledge and acting in accordance with **Good Industry Practice**, the **Power Station** is compliant with the **Grid Code** and the **Bilateral Agreement** in all aspects [with the following **Unresolved Issues***] [with the following derogation(s)**]:

Connection Condition	Requirement	Ref:	Issue

Compliance certified by:	Name: [PERSON]	Title: [PERSON DESIGNATION]
	Signature: [PERSON]	Of
	Date:	[User details]

* Include for Interim User Self Certification of Compliance ahead of Interim Operational Notification.
 ** Include for final User Self Certification of Compliance ahead of Final Operational Notification where derogation(s) have been granted. If no derogation(s) required delete wording and Table.

APPENDIX 3

SIMULATION STUDIES

ECP.A.3.1 SCOPE

ECP.A.3.1.1 This Appendix sets out the simulation studies required to be submitted to **NGET** to demonstrate compliance with the Connection Conditions unless otherwise agreed with **NGET**. This Appendix should be read in conjunction with ECP.6 with regard to the submission of the reports to **NGET**. Where there is any inconsistency in the technical requirements in respect of which compliance is being demonstrated by simulation in this Appendix and ECC.6.3 and the **Bilateral Agreement**, the provisions of the **Bilateral Agreement** and ECC.6.3 prevail. The studies specified in this Appendix will normally be sufficient to demonstrate compliance. However **NGET** may agree an alternative set of studies proposed by the **Generator** or **HVDC System Owner** provided **NGET** deem the alternative set of studies sufficient to demonstrate compliance with the **Grid Code** and the **Bilateral Agreement**.

ECP.A.3.1.2 The **Generator** or **HVDC System Owner** shall submit simulation studies in the form of a report to demonstrate compliance. In all cases the simulation studies must utilise models applicable to the **Synchronous Power Generating Module, HVDC Equipment** or **Power Park Module** with proposed or actual parameter settings. Reports should be submitted in English with all diagrams and graphs plotted clearly with legible axes and scaling provided to ensure any variations in plotted values is clear. In all cases the simulation studies must be presented over a sufficient time period to demonstrate compliance with all applicable requirements.

ECP.A.3.1.3 In the case of an **Offshore Power Station** where **OTSDUW Arrangements** apply simulation studies by the **Generator** should include the action of any relevant **OTSUA** where applicable to demonstrate compliance with the **Grid Code** and the **Bilateral Agreement** at the **Interface Point**.

ECP.A.3.1.4 **NGET** will permit relaxation from the requirement ECP.A.3.2 to ECP.A.3.8 where an **Equipment Certificate** for the **Power Generating Module** or **HVDC Equipment** has been provided which details the characteristics from appropriate simulations on a representative installation with the same equipment and settings and the performance of the **Power Generating Module** or **HVDC Equipment** can, in **NGET**'s opinion, reasonably represent that of the installed **Power Generating Module** or **HVDC Equipment**.

ECP.A.3.1.5 For **Type B, Type C** and **Type D Power Generating Modules** the relevant **Equipment Certificate** must be supplied in the **Power Generating Module Document** or **Users Data File structure** as applicable. For **HVDC Equipment** the relevant **Equipment Certificates** must be supplied in the **Users Data File structure**.

ECP.A.3.2 Power System Stabiliser Tuning

ECP.A.3.2.1 In the case of a **Synchronous Power Generating Module** with an **Excitation System Power System Stabiliser** the **Power System Stabiliser** tuning simulation study report required by ECC.A.6.2.5.6 or required by the **Bilateral Agreement** shall contain:

- (i) the **Excitation System** model including the **Power System Stabiliser** with settings as required under the **Planning Code** (PC.A.5.3.2(c))
- (ii) open circuit time series simulation study of the response of the **Excitation System** to a +10% step change from 90% to 100% terminal voltage.
- (iii) on load time series dynamic simulation studies of the response of the **Excitation System** with and without the **Power System Stabiliser** to 2% and 10% steps in the reference voltage and a three phase short circuit fault applied to the higher voltage side of the **Synchronous Power Generating Module** transformer for 100ms. The simulation studies should be carried out with the **Synchronous Power Generating Module** operating at full **Active Power** and maximum leading **Reactive Power** import with the fault level at the **Supergrid** HV connection point at minimum or as otherwise agreed with **NGET**. The results should show the **Synchronous Power Generating Module** field voltage, terminal voltage, **Power System Stabiliser** output, **Active Power** and **Reactive Power** output.
- (iv) gain and phase Bode diagrams for the open loop frequency domain response of the **Synchronous Power Generating Module Excitation System** with and without the **Power System Stabiliser**. These should be in a suitable format to allow assessment of the phase contribution of the **Power System Stabiliser** and the gain and phase margin of the **Excitation System** with and without the **Power System Stabiliser** in service.
- (v) an eigenvalue plot to demonstrate that all modes remain stable when the **Power System Stabiliser** gain is increased by at least a factor of 3 from the designed operating value.
- (vi) gain Bode diagram for the closed loop on load frequency domain response of the **Synchronous Power Generating Module Excitation System** with and without the **Power System Stabiliser**. The **Synchronous Power Generating Module** operating at full load and at unity power factor. These diagrams should be in a suitable format to allow comparison of the **Active Power** damping across the frequency range specified in ECC.A.6.2.6.3 with and without the **Power System Stabiliser** in service.

ECP.A.3.2.2 In the case of **Onshore Non-Synchronous Power Generating Module, Onshore HVDC Equipment and Onshore Power Park Modules and OTSDUW Plant and Apparatus** at the **Interface Point** the **Power System**

Stabiliser tuning simulation study report required by ECC.A.7.2.4.1 or ECC.A.8.2.4 or required by the **Bilateral Agreement** shall contain:

- (i) the **Voltage Control System** model including the **Power System Stabiliser** with settings as required under the **Planning Code** (PC.A.5.4) and **Bilateral Agreement**.
- (ii) on load time series dynamic simulation studies of the response of the **Voltage Control System** with and without the **Power System Stabiliser** to 2% and 10% steps in the reference voltage and a three phase short circuit fault applied to the **Grid Entry Point** or the **Interface Point** in the case of **OTSDUW Plant** and **Apparatus** for 100ms. The simulation studies should be carried out operating at full **Active Power** and maximum leading **Reactive Power** import condition with the fault level at the **Supergrid** HV connection point at minimum or as otherwise agreed with **NGET**. The results should show appropriate signals to demonstrate the expected damping performance of the **Power System Stabiliser**.
- (iii) any other simulation as specified in the **Bilateral Agreement** or agreed between the **Generator** or **HVDC System Owner** or **Offshore Transmission Licensee** and **NGET**.

ECP.A.3.3 Reactive Capability across the Voltage Range

ECP.A.3.3.1 (a) The **Generator** shall supply simulation studies to demonstrate the capability to meet ECC.6.3.4.1 by submission of a report containing:

- (i) a load flow simulation study result to demonstrate the maximum lagging **Reactive Power** capability of the **Synchronous Power Generating Module, OTSUA** or **Power Park Module** at **Maximum Capacity** when the **Grid Entry Point** or **User System Entry Point** if **Embedded** or **Interface Point** (in the case of **OTSUA**) voltage is at 105% of nominal.
- (ii) a load flow simulation study result to demonstrate the maximum leading **Reactive Power** capability of the **Synchronous Power Generating Module, OTSUA** or **Power Park Module** at **Maximum Capacity** when the **Grid Entry Point** or **User System Entry Point** if **Embedded** or **Interface Point** (in the case of **OTSUA**) voltage is at 95% of nominal.
- (iii) a load flow simulation study result to demonstrate the maximum lagging **Reactive Power** capability of the **Synchronous Power Generating Module OTSUA** or **Power Park Module** at the **Minimum Regulating Level** when the **Grid Entry Point** or **User System Entry Point** if **Embedded** or **Interface Point** (in the case of **OTSUA**) voltage is at 105% of nominal.
- (iv) a load flow simulation study result to demonstrate the maximum leading **Reactive Power** capability of the

Synchronous Power Generating Module, OTSUA or Power Park Module at the **Minimum Regulating Level** when the **Grid Entry Point** or **User System Entry Point** if **Embedded** or **Interface Point** (in the case of **OTSUA**) voltage is at 95% of nominal.

ECP.A.3.3.1 (b) The **HVDC System Owner** shall supply simulation studies to demonstrate the capability to meet ECC.6.3.4.1 by submission of a report containing:

(i) a load flow simulation study result to demonstrate the maximum lagging **Reactive Power** capability of the **Synchronous Power Generating Module, HVDC Equipment, OTSUA or Power Park Module** at **Maximum HVDC Active Power Transmission Capacity** when the **Grid Entry Point** or **User System Entry Point** if **Embedded** or **Interface Point** (in case of **OTSUA**) voltage is at 105% of nominal.

(ii) a load flow simulation study result to demonstrate the maximum leading **Reactive Power** capability of the **Synchronous Power Generating Module, HVDC Equipment, OTSUA or Power Park Module** at **Maximum HVDC Active Power Transmission Capacity** when the **Grid Entry Point** or **User System Entry Point** if **Embedded** or **Interface Point** (in case of **OTSUA**) voltage is at 95% of nominal.

(iii) a load flow simulation study result to demonstrate the maximum lagging **Reactive Power** capability of the **Synchronous Power Generating Module, HVDC Equipment or Power Park Module** at the **Minimum HVDC Active Power Transmission Capacity** when the **Grid Entry Point** or **User System Entry Point** if **Embedded** or **Interface Point** (in case of **OTSUA**) voltage is at 105% of nominal.

(iv) a load flow simulation study result to demonstrate the maximum leading **Reactive Power** capability of the **Synchronous Power Generating Module, HVDC Equipment or Power Park Module** at the **Minimum HVDC Active Power Transmission Capacity** when the **Grid Entry Point** or **User System Entry Point** voltage if **Embedded** or **Interface Point** (in case of **OTSUA**) is at 95% of nominal.

ECP.A.3.3.2 In the case of a **Synchronous Power Generating Module** the terminal voltage in the simulation should be the nominal voltage for the machine.

ECP.A.3.3.3 In the case of a **Power Park Module** where the load flow simulation studies show that the individual **Power Park Units** deviate from nominal voltage to meet the **Reactive Power** requirements then evidence must be provided from factory (e.g. in a **Manufacturer's Data & Performance Report**) or site testing that the **Power Park Unit** is capable of operating continuously at the operating points determined in the load flow simulation studies.

ECP.A.3.4 Voltage Control and Reactive Power Stability

ECP.A.3.4.1 This section applies to **HVDC Equipment**; and **Type C & Type D Power Park Modules** to demonstrate the voltage control capability and **Type B Power Park Modules** to demonstrate the voltage control capability if specified by **NGET**.

In the case of a power station containing **Power Park Modules** and/or **OTSUA** the **Generator** shall provide a report to demonstrate the dynamic capability and control stability of the **Power Park Module**. The report shall contain:

- (i) a dynamic time series simulation study result of a sufficiently large negative step in **System** voltage to cause a change in **Reactive Power** from zero to the maximum lagging value at **Rated MW**.
- (ii) a dynamic time series simulation study result of a sufficiently large positive step in **System** voltage to cause a change in **Reactive Power** from zero to the maximum leading value at **Rated MW**.
- (iii) a dynamic time series simulation study result to demonstrate control stability at the lagging **Reactive Power** limit by application of a -2% voltage step while operating within 5% of the lagging **Reactive Power** limit.
- (iv) a dynamic time series simulation study result to demonstrate control stability at the leading **Reactive Power** limit by application of a +2% voltage step while operating within 5% of the leading **Reactive Power** limit.

ECP.A.3.4.2 All the above studies should be completed with a network operating at the voltage applicable for zero **Reactive Power** transfer at the **Grid Entry Point** or **User System Entry Point** if **Embedded** or, in the case of **OTSUA**, **Interface Point** unless stated otherwise. The fault level at the HV connection point should be set at the minimum level as agreed with **NGET**.

ECP.A.3.5 Fault Ride Through and Fast Fault Current Injection

ECP.A.3.5.1 This section applies to **Type B, Type C and Type D Power Generating Modules** and **HVDC Equipment** to demonstrate the modules fault ride through and **Fast Fault Current** injection capability.

The **Generator** or **HVDC System Owner** shall supply time series simulation study results to demonstrate the capability of **Synchronous Power Generating Module, HVDC Equipment, and Power Park Modules** and **OTSUA** to meet **ECC.6.3.15** and **ECC.6.3.16** by submission of a report containing:

- (i) a time series simulation study of a 140ms three phase short circuit fault with a retained voltage as detailed in table A.3.5.1 below applied at the **Grid Entry Point** or (**User System Entry**

Point if Embedded) of the Power Generating Module or HVDC Equipment or OTSUA.

(ii) a time series simulation study of 140ms unbalanced short circuit faults with a retained voltage as detailed in table 1 on the faulted phase(s) applied at the **Grid Entry Point** or (**User System Entry Point if Embedded**) of the **Power Generating Module** or **HVDC Equipment** or **OTSUA**. The unbalanced faults to be simulated are:

1. a phase to phase fault
2. a two phase to earth fault
3. a single phase to earth fault.

Power Generating Module	Retained Voltage
Synchronous Power Generating Module	
Type B	30%
Type C or Type D with Grid connection point voltage <110kV	10%
Type D with connection point voltage >110kV	0%
Power Park Module	
Type B or Type C or Type D with connection point voltage < 110kV	10%
Type D with connection point voltage >110kV	0%
HVDC Equipment	10%

Table A.3.5.1

For a **Power Generating Module** or **HVDC Equipment** or **OTSUA** the simulation study should be completed with the **Power Generating Module** or **HVDC Equipment** or **OTSUA** operating at full **Active Power** and maximum leading **Reactive Power** and the fault level at the **Supergrid** HV connection point at minimum or as otherwise agreed with **NGET** as detailed in ECC.6.3.15.8.

(iii) time series simulation studies of balanced **Supergrid** voltage dips applied on the nearest point of the **National Electricity Transmission System** operating at **Supergrid** voltage to the **Synchronous Power Generating Module** or **OTSUA**. The simulation studies should include:

1. 50% retained voltage lasting 0.45 seconds
2. 70% retained voltage lasting 0.81 seconds
3. 80% retained voltage lasting 1.00 seconds
4. 85% retained voltage lasting 180 seconds.

For a **Synchronous Power Generating Module** or **OTSUA**, the simulation study should be completed with the **Synchronous Power Generating Module** or **OTSUA** operating at full **Active Power** and zero **Reactive Power** output and the fault level at the **Supergrid** HV connection point at minimum or as otherwise agreed with **NGET**. Where the **Synchronous Power Generating Module** is **Embedded** the minimum **Network Operator's System** impedance to the

Supergrid HV connection point shall be used which may be calculated from the maximum fault level at the **User System Entry Point**.

(iii) time series simulation studies of balanced **Supergrid** voltage dips applied on the nearest point of the **National Electricity Transmission System** operating at **Supergrid** voltage to the **HVDC Equipment** or **Power Park Module**. The simulation studies should include:

1. 30% retained voltage lasting 0.384 seconds
2. 50% retained voltage lasting 0.71 seconds
3. 80% retained voltage lasting 2.5 seconds
4. 85% retained voltage lasting 180 seconds.

For **HVDC Equipment** or **Power Park Modules** the simulation study should be completed with the **HVDC Equipment** or **Power Park Module** operating at full **Active Power** and zero **Reactive Power** output and the fault level at the **Supergrid** HV connection point at minimum or as otherwise agreed with **NGET**. Where the **HVDC Equipment** or **Power Park Module** is **Embedded** the minimum **Network Operator's System** impedance to the **Supergrid** HV connection point shall be used which may be calculated from the maximum fault level at the **User System Entry Point**.

For **HVDC Equipment** the simulations should include the duration of each voltage dip 1 to 4 above for which the **HVDC Equipment** will remain connected.

ECP.A.3.5.2 In the case of **Power Park Modules** comprised of **Power Park Units** in respect of which the **User's** reference to a **Manufacturer's Data & Performance Report** has been accepted by **NGET** for Fault Ride Through, **ECP.A.3.5.1** will not apply provided:

(i) the **Generator** or **HVDC System Owner** demonstrates by load flow simulation study result that the faults and voltage dips at either side of the **Power Park Unit** transformer corresponding to the required faults and voltage dips in **ECP.A.3.5.1** applied at the nearest point of the **National Electricity Transmission System** operating at **Supergrid** voltage are less than those included in the **Manufacturer's Data & Performance Report**,

or;

(ii) the same or greater percentage faults and voltage dips in **ECP.A.3.5.1** have been applied at either side of the **Power Park Unit** transformer in the **Manufacturer's Data & Performance Report**.

ECP.A.3.6 Limited Frequency Sensitive Mode – Over Frequency (LFSM-O)

ECP.A.3.6.1 This section applies to **Type B, Type C and Type D Power Generating Modules, HVDC Equipment** to demonstrate the capability to modulate **Active Power** at high frequency as required by **ECC6.3.7.3.5(ii)**.

ECP.A.3.6.2 The simulation study should comprise of a **Power Generating Module** or **HVDC Equipment** connected to the total **System** with a local load shown as "X" in figure ECP.A.3.6.1. The load "X" is in addition to any auxiliary load of the **Power Station** connected directly to the **Power Generating Module** or **HVDC Equipment** and represents a small portion of the **System** to which the **Power Generating Module** or **HVDC Equipment** is attached. The value of "X" should be the minimum for which the **Power Generating Module** or **HVDC Equipment** can control the power island frequency to less than 52Hz consistent with ECC.6.3.7.3.5(ii). Where transient excursions above 52Hz occur the **Generator** or **HVDC Equipment Owner** should ensure that the duration above 52Hz is less than any high frequency protection system applied to the **Power Generating Module** or **HVDC Equipment**.

ECP.A.3.6.3 For **HVDC Equipment** and **Power Park Modules** consisting of units connected wholly by power electronic devices the simulation methodology may be modified by the addition of a **Synchronous Power Generating Module** (G2) connected as indicated in Figure ECP.A.3.6.2. This additional **Synchronous Power Generating Module** should have an inertia constant of 3.5MWs/MVA, be initially operating at rated power output and unity power factor. The mechanical power of the **Synchronous Power Generating Module** (G2) should remain constant throughout the simulation.

ECP.A.3.6.4 At the start of the simulation study the **Power Generating Module** or **HVDC Equipment** will be operating maximum **Active Power** output. The **Power Generating Module** or **HVDC Equipment** will then be islanded from the **Total System** but still supplying load "X" by the opening of a breaker, which is not the **Power Generating Module** or **HVDC Equipment** connection circuit breaker (the governor should therefore, not receive any signals that the breaker has opened other than the reduction in load and subsequent increase in speed). A schematic arrangement of the simulation study is illustrated by Figure ECP.A.3.6.1.

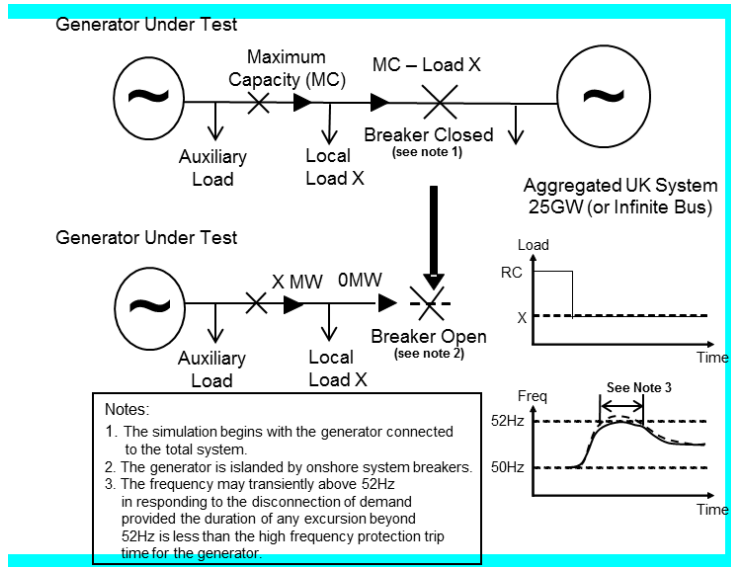

Figure ECP.A.3.6.1 – Diagram of Load Rejection Study

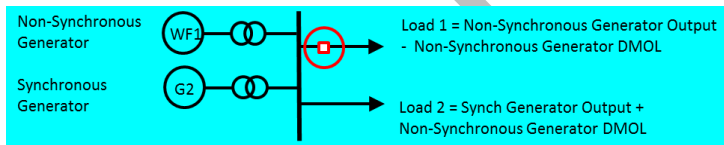

Figure ECP.A.3.6.2 – Addition of Generator G2 if applicable

ECP.A.3.6.5 Simulation study shall be performed for type B, C & D in **Limited Frequency Sensitive Mode (LFSM)** and **Frequency Sensitive Mode (FSM)** for type C & D. The simulation study results should indicate **Active Power** and **Frequency**.

ECP.A.3.6.6 To allow validation of the model used to simulate load rejection in accordance with ECC.6.3.7.3.5 as described a further simulation study is required to represent the largest positive **Frequency** injection step or fast ramp (BC1 and BC3 of Figure 2) that will be applied as a test as described in ECP.A.5.8 and ECP.A.6.6.

Limited Frequency Sensitive Mode – Under Frequency (LFSM-U)

ECP.A.3.6.7 This section applies to: **Synchronous Power Generating Modules, Type C & D; or, HVDC Equipment; or, Power Park Modules, Type C & D** to demonstrate the modules capability to modulate Active Power at low frequency.

ECP.A.3.6.8 To demonstrate the LFSM-U low **Frequency** control when operating in **Limited Frequency Sensitive Mode** the **Generator** or **HVDC System**

Owner shall submit a simulation study representing the response of the **Power Generating Module or HVDC Equipment** operating at 80% of **Maximum Capacity**. The simulation study event shall be equivalent to:

- (i) a sufficiently large reduction in the measured **System Frequency** ramped over 10 seconds to cause an increase in Active Power output to the **Maximum Capacity** followed by
- (ii) 60 seconds of steady state with the measured **System Frequency** depressed to the same level as in ECP.A.3.6.8.1 (i) as illustrated in Figure ECP.A.3.6.1 below.
- (iii) then increase of the measured **System Frequency** ramped over 10 seconds to cause a reduction in Active Power output back to the original Active Power level followed by at least 60 seconds of steady output.

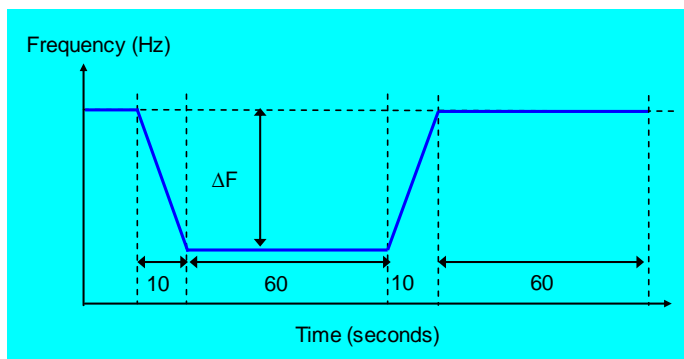

Figure ECP.A.3.6.1

ECP.A.3.7 Voltage and Frequency Controller Model Verification and Validation

ECP.A.3.7.1 For **Type C** and **Type D Synchronous Power Generating Modules, HVDC Equipment or Power Park Modules** the **Generator or HVDC System Owner** shall provide simulation studies to verify that the proposed controller models supplied to **NGET** under the **Planning Code** are fit for purpose. These simulation study results shall be provided in the timescales stated in the **Planning Code**.

ECP.A.3.7.2 To demonstrate the **Frequency** control or governor/load controller/plant model the **Generator or HVDC System Owner** shall submit a simulation study representing the response of the **Synchronous Power Generating Module, HVDC Equipment or Power Park Module** operating at 80% of **Maximum Capacity**. The simulation study event shall be equivalent to:

- (i) a ramped reduction in the measured **System Frequency** of 0.5Hz in 10 seconds followed by
- (ii) 20 seconds of steady state with the measured **System Frequency** depressed by 0.5Hz followed by
- (iii) a ramped increase in measured **System Frequency** of 0.3Hz over 30 seconds followed by

(iv) 60 seconds of steady state with the measured **System Frequency** depressed by 0.2Hz as illustrated in Figure ECP.A.3.7.2 below.

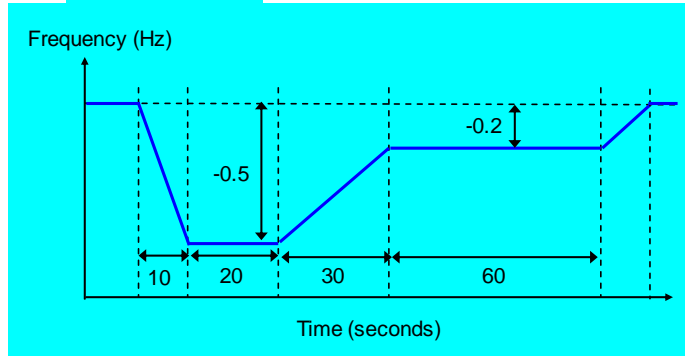

Figure ECP.A.3.7.2

The simulation study shall show **Active Power** output (MW) and the equivalent of **Frequency** injected.

ECP.A.3.7.3 To demonstrate the **Excitation System** model the **Generator** shall submit simulation studies representing the response of the **Synchronous Power Generating Module** as follows:

- (i) operating open circuit at rated terminal voltage and subjected to a 10% step increase in terminal voltage reference from 90% to 100%.
- (ii) operating at **Rated MW**, nominal terminal voltage and unity power factor subjected to a 2% step increase in the voltage reference. Where a **Power System Stabiliser** is included within the **Excitation System** this shall be in service.

The simulation study shall show the **Synchronous Power Generating Module** terminal voltage, field voltage, **Active Power**, **Reactive Power** and **Power System Stabiliser** output signal as appropriate.

ECP.A.3.7.4 To demonstrate the Voltage Controller model the **Generator** or **HVDC System Owner** shall submit a simulation study representing the response of the **HVDC Equipment** or **Power Park Module** operating at **Rated MW** and unity power factor at the connection point to a 2% step increase in the voltage reference. The simulation study shall show the terminal voltage, **Active Power**, **Reactive Power** and **Power System Stabiliser** output signal as appropriate.

ECP.A.3.7.5 To validate that the excitation and voltage control models submitted under the **Planning Code** are a reasonable representation of the dynamic behaviour of the **Synchronous Power Generating Module**, **HVDC Equipment** or **Power Park Module** as built, the **Generator** or **HVDC System Owner** shall repeat the simulation studies outlined above but using the operating conditions of the equivalent tests. The simulation study results shall be displayed overlaid on the actual test results.

ECP.A.3.7.6 For **Type C** and **Type D Synchronous Power Generating Modules** or **HVDC Equipment** to validate that the governor/load controller/plant or **Frequency** control models submitted under the **Planning Code** is a reasonable representation of the dynamic behaviour of the **Synchronous Power Generating Module** or **HVDC Equipment Station** as built, the **Generator** or **HVDC System Owner** shall repeat the simulation studies outlined above but using the operating conditions of the equivalent tests. The simulation study results shall be displayed overlaid on the actual test results.

ECP.A.3.8 Sub-synchronous Resonance control and Power Oscillation Damping control for **HVDC System**.

ECP.A.3.8.1 To demonstrate the compliance of the sub-synchronous control capability with ECC.6.3.17.1) and the terms of the **Bilateral Agreement** the **HVDC System Owner** shall submit a simulation study report

ECP.A.3.8.2 Where power oscillation damping control function is specified on a **HVDC Equipment** the **HVDC System Owner** shall submit a simulation study report to demonstrate the compliance with ECC.6.3.17.2 and the terms of the **Bilateral Agreement**.

ECP.A.3.8.3 The simulation studies should utilise the **HVDC Equipment** control system models including the settings as required under the **Planning Code** (PC.A.5.3.2). The network conditions for the above simulation studies should be discussed with **NGET** prior to commencing any simulation studies.

APPENDIX 4

ONSITE SIGNAL PROVISION FOR WITNESSING TESTS

ECP.A.4.1 During any tests witnessed on-site by **NGET**, the following signals shall be provided to **NGET** by the **Generator** undertaking **OTSDUW** or **HVDC System Owner** in accordance with ECC.6.6.3.

ECP.A.4.2 Synchronous Power Generating Modules

ECP.A.4.2(a) All Tests	<ul style="list-style-type: none"> • MW - Active Power at Synchronous Generating Unit terminals
ECP.A.4.2(b) Reactive & Excitation System	<ul style="list-style-type: none"> • MVA_r - Reactive Power at terminals • V_t - Synchronous Generating Unit terminal voltage • E_{fd} - Synchronous Generating Unit field voltage and/or main exciter field voltage • I_{fd} - Synchronous Generating Unit Field current (where possible) • Power System Stabiliser output, where applicable. • Noise - Injected noise signal (where applicable and possible)
ECP.A.4.2(c) Governor System & Frequency Response	<ul style="list-style-type: none"> • F_{sys} - System Frequency • Finj - Injected Speed Setpoint • Logic - Stop / Start Logic Signal <p>For Gas Turbines:</p> <ul style="list-style-type: none"> • GT Fuel Demand • GT Fuel Valve Position • GT Inlet Guide Vane Position • GT Exhaust Gas Temperature <p>For Steam Turbines at >= 1Hz:</p> <ul style="list-style-type: none"> • Pressure before Turbine Governor Valves • Turbine Governor Valve Positions • Governor Oil Pressure* • Boiler Pressure Set Point * • Superheater Outlet Pressure * • Pressure after Turbine Governor Valves* • Boiler Firing Demand* <p>*Where applicable (typically not in CCGT module)</p> <p>For Hydro Plant:</p> <ul style="list-style-type: none"> • Speed Governor Demand Signal • Actuator Output Signal • Guide Vane / Needle Valve Position
ECP.A.4.2(d) Compliance with ECC.6.3.3	<ul style="list-style-type: none"> • F_{sys} - System Frequency • Finj - Injected Speed Setpoint • Appropriate control system parameters as agreed with NGET (See ECP.A.5.9)
ECP.A.4.2(e) Real Time on site	<ul style="list-style-type: none"> • MW - Synchronous Power Generating Module Active Power at the Grid Entry

or Down-loadable	<p>Point or (User System Entry Point if Embedded).</p> <ul style="list-style-type: none"> • MVAR - Synchronous Power Generating Module Reactive Power at the Grid Entry Point or (User System Entry Point if Embedded). • Line-line Voltage (kV) at the Grid Entry Point or (User System Entry Point if Embedded).
------------------	--

ECP.A.4.3 Power Park Modules, OTSDUA and HVDC Equipment

	<p>Each Power Park Module and HVDC Equipment at Grid Entry Point or User System Entry Point</p>
ECP.A.4.3.1(a) Real Time on site.	<ul style="list-style-type: none"> • Total Active Active Power (MW) • Total Reactive Power (MVAR) • Line-line Voltage (kV) • System Frequency (Hz)
ECP.A.4.3.1(b) Real Time on site or Down-loadable	<ul style="list-style-type: none"> • Injected frequency signal (Hz) or test logic signal (Boolean) when appropriate • Injected voltage signal (per unit voltage) or test logic signal (Boolean) when appropriate • In the case of an Onshore Power Park Module the Onshore Power Park Module site voltage (MV) (kV) • Power System Stabiliser output, where appropriate • In the case of a Power Park Module or HVDC Equipment where the Reactive Power is provided by from more than one Reactive Power source, the individual Reactive Power contributions from each source, as agreed with NGET. • In the case of HVDC Equipment appropriate control system parameters as agreed with NGET (See ECP.A.7) • In the case of an Offshore Power Park Module the Total Active Power (MW) and the Total Reactive Power (MVAR) at the offshore Grid Entry Point
ECP.A.4.3.1(c) Real Time on site or Down-loadable	<ul style="list-style-type: none"> • Available power for Power Park Module (MW) • Power source speed for Power Park Module (e.g. wind speed) (m/s) when appropriate • Power source direction for Power Park Module (degrees) when appropriate <p>See ECP.A.4.3.2</p>

ECP.A.4.3.2 NGET accept that the signals specified in ECP.A.4.3.1(c) may have lower effective sample rates than those required in ECC.6.6.3 although any signals supplied for connection to **NGET's** recording equipment which do not meet at least the sample rates detailed in

ECC.6.6.3 should have the actual sample rates indicated to NGET before testing commences.

ECP.A.4.3.3 For all NGET witnessed testing either;

- (i) the Generator or HVDC System Owner shall provide to NGET all signals outlined in ECP.A.4.3.1 direct from the Power Park Module control system without any attenuation, delay or filtering which would result in the inability to fully demonstrate the objectives of the test, or identify any potential safety or plant instability issues, and with a signal update rate corresponding to ECC.6.6.3.2; or
- (ii) in the case of Onshore Power Park Modules the Generator HVDC System Owner shall provide signals ECP.A.4.3.1(a) direct from one or more transducer(s) connected to current and voltage transformers for monitoring in real time on site; or,
- (iii) In the case of Offshore Power Park Modules and OTSDUA signals ECP.A.4.3.1(a) will be provided at the Interface Point by the Offshore Transmission Licensee pursuant to the STC or by the Generator when Generator when OTSDUW Arrangements apply.

ECP.A.4.3.4 Options ECP.A.4.3.3 (ii) and (iii) will only be available on condition that;

- (a) all signals outlined in ECP.A.4.3.1 are recorded and made available to NGET by the Generator or HVDC System Owner from the Power Park Module or OTSDUA or HVDC Equipment control systems as a download once the testing has been completed; and
- (b) the full test results are provided by the Generator HVDC System Owner within 2 working days of the test date to NGET unless NGET agrees otherwise; and
- (c) all data is provided with a sample rate in accordance with ECC.6.6.3.3 unless NGET agrees otherwise; and
- (d) in NGET's reasonable opinion the solution does not unreasonably add a significant delay between tests or impede the volume of testing which can take place on the day.

ECP.A.4.3.5 In the case of where transducers connected to current and voltage transformers are installed (ECP.A.4. 3.3(ii) and (iii)), the transducers shall meet the following specification

- (a) The transducer(s) shall be permanently installed to easily allow safe testing at any point in the future, and to avoid a requirement for recalibration of the current transformers and voltage transformers.
- (b) The transducer(s) should be directly connected to the metering quality current transformers and voltage transformers or similar.

(c) The transducers shall either have a response time no greater than 50ms to reach 90% of output, or no greater than 300ms to reach 99.5%.

DRAFT

APPENDIX 5

COMPLIANCE TESTING OF SYNCHRONOUS POWER GENERATING MODULES

ECP.A.5.1 SCOPE

ECP.A.5.1.1 This Appendix sets out the tests contained therein to demonstrate compliance with the relevant clauses of the European Connection Conditions of the **Grid Code**. This Appendix shall be read in conjunction with the ECP with regard to the submission of the reports to **NGET**.

ECP.A.5.1.2 The tests specified in this Appendix will normally be sufficient to demonstrate compliance however **NGET** may:

- (i) agree an alternative set of tests provided **NGET** deem the alternative set of tests sufficient to demonstrate compliance with the **Grid Code** and **Bilateral Agreement**; and/or
- (ii) require additional or alternative tests if information supplied to **NGET** during the compliance process suggests that the tests in this Appendix will not fully demonstrate compliance with the relevant section of the **Grid Code** or **Bilateral Agreement**.
- (iii) Agree a reduced set of tests for subsequent **Synchronous Power Generating Module** following successful completion of the first **Synchronous Power Generating Module** tests in the case of a **Power Station** comprised of two or more **Synchronous Power Generating Module** which **NGET** reasonably considers to be identical.

If:

- (a) the tests performed pursuant to ECP.A.5.1.2(iii) in respect of subsequent **Synchronous Power Generating Modules** do not replicate the full tests for the first **Synchronous Power Generating Module**, or
- (b) any of the tests performed pursuant to ECP.A.5.1.2(iii) do not fully demonstrate compliance with the relevant aspects of the **Grid Code**, **Ancillary Services Agreement** and / or **Bilateral Agreement**.

then notwithstanding the provisions above, the full testing requirements set out in this Appendix will be applied.

ECP.A.5.1.3 The **Generator** is responsible for carrying out the tests set out in and in accordance with this Appendix and the **Generator** retains the responsibility for the safety of personnel and plant during the test. **NGET** will witness all of the tests outlined or agreed in relation to this Appendix unless **NGET** decides and notifies the **Generator** otherwise. Reactive Capability tests may be witnessed by **NGET** remotely from the **NGET** control centre. For all on site **NGET** witnessed tests the **Generator** should ensure suitable representatives from the **Generator** and manufacturer (if appropriate) are available on site for the entire

testing period. In all cases the **Generator** shall provide suitable monitoring equipment to record all relevant test signals as outlined below in ECP.A.6.1.5.

ECP.A.5.1.6 The **Generator** shall submit a schedule of tests to **NGET** in accordance with CP.4.3.1.

ECP.A.5.1.7 Prior to the testing of a **Synchronous Power Generating Module** the **Generator** shall complete the **Integral Equipment Test** procedure in accordance with OC.7.5.

ECP.A.5.1.8 Full **Synchronous Power Generating Module** testing as required by CP.7.2 is to be completed as defined in ECP.A.5.2 through to ECP.A.5.9.

ECP.A.5.1.9 **NGET** will permit relaxation from the requirement ECP.A.5.2 to ECP.A.5.9 where an **Equipment Certificate** for the **Synchronous Power Generating Module** has been provided which details the characteristics from tests on a representative machine with the same equipment and settings and the performance of the **Synchronous Power Generating Module** can, in **NGET's** opinion, reasonably represent that of the installed **Synchronous Power Generating Module** at that site. For **Type B, Type C** and **Type D Power Generating Modules** the relevant **Equipment Certificate** must be supplied in the **Power Generating Module Document** or **Users Data File structure** as applicable.

ECP.A.5.2 Excitation System Open Circuit Step Response Tests

ECP.A.5.2.1 The open circuit step response of the **Excitation System** will be tested by applying a voltage step change from 90% to 100% of the nominal **Synchronous Power Generating Module** terminal voltage, with the **Synchronous Power Generating Module** on open circuit and at rated speed.

ECP.A.5.2.1 The test shall be carried out prior to synchronisation in accordance with CP.6.4. This is not witnessed by **NGET** unless specifically requested by **NGET**. Where **NGET** is not witnessing the tests, the Generator shall supply the recordings of the following signals to **NGET** in an electronic spreadsheet format:

Vt - **Synchronous Generating Unit** terminal voltage

Efd - **Synchronous Generating Unit** field voltage or main exciter field voltage

Ifcd- **Synchronous Generating Unit** field current (where possible)
Step injection signal

ECP.A.5.2.3 Results shall be legible, identifiable by labelling, and shall have appropriate scaling.

ECP.A.5.3 Open & Short Circuit Saturation Characteristics

ECP.A.5.3.1 The test shall normally be carried out prior to synchronisation in accordance with ECP.6.2.4 or ECP.6.3.4 **Equipment Certificates** or **Manufacturer's Test Certificates** may be used where appropriate may

be used if agreed by NGET.

ECP.A.5.3.2 This is not witnessed by NGET. Graphical and tabular representations of the results in an electronic spreadsheet format showing per unit open circuit terminal voltage and short circuit current versus per unit field current shall be submitted to NGET.

ECP.A.5.3.3 Results shall be legible, identifiable by labelling, and shall have appropriate scaling.

ECP.A.5.4 **Excitation System On-Load Tests**

ECP.A.5.4.1 The time domain performance of the **Excitation System** shall be tested by application of voltage step changes corresponding to 1% and 2% of the nominal terminal voltage.

ECP.A.5.4.2 Where a **Power System Stabiliser** is present:

- (i) The **PSS** must only be commissioned in accordance with BC2.11.2. When a **PSS** is switched on for the first time as part of on-load commissioning or if parameters have been adjusted the **Generator** should consider reducing the **PSS** output gain by at least 50% and should consider reducing the limits on **PSS** output by at least a factor of 5 to prevent unexpected **PSS** action affecting the stability of the **Synchronous Generating Unit** or the **National Electricity Transmission System**.
- (ii) The time domain performance of the **Excitation System** shall be tested by application of voltage step changes corresponding to 1% and 2% of the nominal terminal voltage, repeating with and without the **PSS** in service.
- (iii) The frequency domain tuning of the **PSS** shall also be demonstrated by injecting a 0.2Hz-3Hz band limited random noise signal into the **Automatic Voltage Regulator** Setpoint with the **Synchronous Generating Unit** operating at points specified by NGET (up to rated MVA output).
- (iv) The **PSS** gain margin shall be tested by increasing the **PSS** gain gradually to threefold and observing the **Synchronous Generating Unit** steady state **Active Power** output.
- (v) The interaction of the **PSS** with changes in **Active Power** shall be tested by application of a +0.5Hz frequency injection to the governor while the **Synchronous Generating Unit** is selected to **Frequency Sensitive Mode**.
- (vi) If the **Synchronous Power Generating Module** is of the **Pumped Storage** type then the step tests shall be carried out, with and without the **PSS**, in the pumping mode in addition to the generating mode.
- (vii) Where the **Bilateral Agreement** requires that the **PSS** is in service at a specified loading level additional testing witnessed by NGET will be required during the commissioning process

before the **Synchronous Power Generating Module** may exceed this output level.

(viii) Where the **Excitation System** includes a **PSS**, the **Generator** shall provide a suitable noise source to facilitate noise injection testing.

ECP.A.5.4.3 The following typical procedure is provided to assist **Generators** in drawing up their own site specific procedures for the **NGET** witnessed **PSS** Tests.

Test	Injection	Notes
	Synchronous Generating Unit running at Maximum Capacity, unity pf, PSS Switched Off	
1	<ul style="list-style-type: none"> Record steady state for 10 seconds Inject +1% step to AVR Voltage Setpoint and hold for at least 10 seconds until stabilised Remove step returning AVR Voltage Setpoint to nominal and hold for at least 10 seconds 	
2	<ul style="list-style-type: none"> Record steady state for 10 seconds Inject +2% step to AVR Voltage Setpoint and hold for at least 10 seconds until stabilised Remove step returning AVR Voltage Setpoint to nominal and hold for at least 10 seconds 	
3	<ul style="list-style-type: none"> Inject band limited (0.2-3Hz) random noise signal into voltage Setpoint and measure frequency spectrum of Real Power. Remove noise injection. 	
	Switch On Power System Stabiliser	
4	<ul style="list-style-type: none"> Record steady state for 10 seconds Inject +1% step to AVR Voltage Setpoint and hold for at least 10 seconds until stabilised Remove step returning AVR Voltage Setpoint to nominal and hold for at least 10 seconds 	
5	<ul style="list-style-type: none"> Record steady state for 10 seconds Inject +2% step to AVR Voltage Setpoint and hold for at least 10 seconds until stabilised Remove step returning AVR Voltage Setpoint to nominal and hold for at least 10 seconds 	
6	<ul style="list-style-type: none"> Increase PSS gain at 30second intervals. i.e. x1 – x1.5 – x2 – x2.5 – x3 Return PSS gain to initial setting 	
7	<ul style="list-style-type: none"> Inject band limited (0.2-3Hz) random noise signal into voltage Setpoint and measure frequency spectrum of Real Power. Remove noise injection. 	
8	<ul style="list-style-type: none"> Select the governor to FSM Inject +0.5 Hz step into governor. Hold until generator MW output is stabilised Remove step 	

ECP.A.5.5 **Under-excitation Limiter Performance Test**

ECP.A.5.5.1 Initially the performance of the **Under-excitation Limiter** should be checked by moving the limit line close to the operating point of the **Synchronous Generating Unit** when operating close to unity power factor. The operating point of the **Synchronous Generating Unit** is then stepped into the limit by applying a 2% decrease in **Automatic Voltage Regulator Setpoint voltage**.

ECP.A.5.5.2 The final performance of the **Under-excitation Limiter** shall be demonstrated by testing its response to a step change corresponding to a 2% decrease in **Automatic Voltage Regulator Setpoint voltage** when the **Synchronous Generating Unit** is operating just off the limit line, at the designed setting as indicated on the **Performance Chart [P-Q Capability Diagram]** submitted to **NGET** under OC2.

ECP.A.5.5.3 Where possible the **Under-excitation Limiter** should also be tested by operating the tap- changer when the **Synchronous Generating Unit** is operating just off the limit line, as set up.

ECP.A.5.5.4 The **Under-excitation Limiter** will normally be tested at low active power output and at maximum **Active Power** output.

ECP.A.5.5.5 The following typical procedure is provided to assist **Generators** in drawing up their own site specific procedures for the **NGET** witnessed **Under-excitation Limiter Tests**.

Test	Injection	Notes
	Synchronous Generating Unit running at Maximum Capacity and unity power factor. Under-excitation limit temporarily moved close to the operating point of the Synchronous Generating Unit .	
1	<ul style="list-style-type: none"> • PSS on. • Inject -2% voltage step into AVR voltage Setpoint and hold at least for 10 seconds until stabilised • Remove step returning AVR Voltage Setpoint to nominal and hold for at least 10 seconds 	
	Under-excitation limit moved to normal position. Synchronous Generating Unit running at Maximum Capacity and at leading Reactive Power close to Under-excitation limit.	
2	<ul style="list-style-type: none"> • PSS on. • Inject -2% voltage step into AVR voltage Setpoint and hold at least for 10 seconds until stabilised • Remove step returning AVR Voltage Setpoint to nominal and hold for at least 10 seconds 	

ECP.A.5.6 Over-excitation Limiter Performance Test

ECP.A.5.6.1 The performance of the **Over-excitation Limiter**, where it exists, shall be demonstrated by testing its response to a step increase in the **Automatic Voltage Regulator Setpoint voltage** that results in operation of the **Over-excitation Limiter**. Prior to application of the step the **Synchronous Generating Unit** shall be generating **Maximum Capacity** and operating within its continuous **Reactive Power** capability. The size of the step will be determined by the minimum value necessary to operate the **Over-excitation Limiter** and will be

agreed by **NGET** and the **Generator**. The resulting operation beyond the **Over-excitation Limit** shall be controlled by the **Over-excitation Limiter** without the operation of any protection that could trip the **Synchronous Power Generating Module**. The step shall be removed immediately on completion of the test.

ECP.A.5.6.2 If the **Over-excitation Limiter** has multiple levels to account for heating effects, an explanation of this functionality will be necessary and if appropriate, a description of how this can be tested.

ECP.A.5.6.3 The following typical procedure is provided to assist **Generators** in drawing up their own site specific procedures for the **NGET** witnessed **Under-excitation Limiter Tests**.

Test	Injection	Notes
	Synchronous Generating Unit running at Maximum Capacity and maximum lagging Reactive Power .	
	Over-excitation Limit temporarily set close to this operating point. PSS on.	
1	<ul style="list-style-type: none"> • Inject positive voltage step into AVR voltage Setpoint and hold • Wait till Over-excitation Limiter operates after sufficient time delay to bring back the excitation back to the limit. • Remove step returning AVR Voltage Setpoint to nominal. 	
	Over-excitation Limit restored to its normal operating value. PSS on.	

ECP.A.5.7 Reactive Capability

ECP.A.5.7.1 The **Reactive Power** capability on each **Synchronous Power Generating Module** will normally be demonstrated by :

(a) operation of the **Synchronous Power Generating Module** at maximum lagging **Reactive Power** and Maximum Capacity for 1 hour

(b) operation of the **Synchronous Power Generating Module** at maximum leading **Reactive Power** and Maximum Capacity for 1 hour.

(c) operation of the **Synchronous Power Generating Module** at maximum lagging **Reactive Power** and **Minimum Stable Operating Level** for 1 hour

(d) operation of the **Synchronous Power Generating Module** at maximum leading **Reactive Power** and **Minimum Stable Operating Level** for 1 hour.

(e) operation of the **Synchronous Power Generating Module** at maximum lagging **Reactive Power** and a power output between **Maximum Capacity** and **Minimum Stable Operating Level**.

(f) operation of the **Synchronous Power Generating Module** at maximum leading **Reactive Power** and a power output between **Maximum Capacity** and **Minimum Stable Operating Level**.

ECP.A.5.7.2 In the case of an **Embedded Synchronous Power Generating Module** where distribution network considerations restrict the **Synchronous Power Generating Module Reactive Power Output** **NGET** will only require demonstration within the acceptable limits of the **Network Operator's System**.

ECP.A.5.7.3 The test procedure, time and date will be agreed with **NGET** and will be to the instruction of **NGET** control centre and shall be monitored and recorded at both the **NGET** control centre and by the **Generator**.

ECP.A.5.7.4 Where the **Generator** is recording the voltage, **Active Power** and **Reactive Power** at the HV connection point the voltage for these tests **Active Power** and **Reactive Power** at the **Synchronous Power Generating Module** terminals may also be included. The results shall be supplied in an electronic spreadsheet format. Where applicable the **Synchronous Power Generating Module** transformer tapchanger position should be noted throughout the test period.

ECP.A.5.8 Governor and Load Controller Response Performance

ECP.A.5.8.1 The governor and load controller response performance will be tested by injecting simulated frequency deviations into the governor and load controller systems. Such simulated frequency deviation signals must be injected simultaneously at both speed governor and load controller setpoints. For **CCGT modules**, simultaneous injection into all gas turbines, steam turbine governors and module controllers is required.

ECP.A.5.8.2 Prior to witnessing the governor tests set out in ECP.A.5.8.6, **NGET** requires the **Generator** to conduct the preliminary tests detailed in ECP.A.5.8.4 and send the results to **NGET** for assessment unless agreed otherwise by **NGET**. The results should be supplied in an electronic spreadsheet format. These tests shall be completed at least two weeks prior to the witnessed governor response tests.

ECP.A.5.8.3 Where a **CCGT module** or **Synchronous Power Generating Module** is capable of operating on alternative fuels, tests will be required to demonstrate performance when operating on each fuel. **NGET** may agree a reduction from the tests listed in ECP.A.5.8.6 for demonstrating performance on the alternative fuel. This includes the case where a main fuel is supplemented by bio-fuel.

Preliminary Governor Frequency Response Testing

ECP.A.5.8.4 Prior to conducting the full set of tests as per ECP.A.5.8.6, **Generators** are required to conduct a preliminary set of tests below to confirm the frequency injection method is correct and the plant control performance is within expectation. The test numbers refer to Figure 1 below. With the plant running at 80% of full load, the following frequency injections shall be applied.

Test No (Figure1)	Frequency Injection	Notes
8	<ul style="list-style-type: none"> • Inject -0.5Hz frequency fall over 10 sec • Hold for a further 20 sec • At 30 sec from the start of the test, Inject a +0.3Hz frequency 	

	<ul style="list-style-type: none"> rise over 30 sec. Hold until conditions stabilise Remove the injected signal as a ramp over 10 seconds 	
13	<ul style="list-style-type: none"> Inject - 0.5Hz frequency fall over 10 sec Hold until conditions stabilise Remove the injected signal as a ramp over 10 seconds 	
14	<ul style="list-style-type: none"> Inject +0.5Hz frequency rise over 10 sec Hold until conditions stabilise Remove the injected signal as a ramp over 10 seconds 	
H	<ul style="list-style-type: none"> Inject - 0.5Hz frequency fall as a stepchange Hold until conditions stabilise Remove the injected signal as a stepchange 	
I	<ul style="list-style-type: none"> Inject +0.5Hz frequency rise as a stepchange Hold until conditions stabilise Remove the injected signal as a stepchange 	

ECP.A.5.8.5 The recorded results (e.g. Finj, MW and control signals) should be sampled at a minimum rate of 1 Hz to allow NGET to assess the plant performance from the initial transients (seconds) to the final steady state conditions (5-15 minutes depending on the plant design). This is not witnessed by NGET. The Generator shall supply the recordings including data to NGET in an electronic spreadsheet format. Results shall be legible, identifiable by labelling, and shall have appropriate scaling.

Full Frequency Response Testing Schedule Witnessed by NGET

ECP.A.5.8.6 The tests are to be conducted at a number of different Module Load Points (MLP). The load points are conducted as shown below unless agreed otherwise by NGET.

Module Load Point 6 (Maximum Export Limit)	100% MEL
Module Load Point 5	95% MEL
Module Load Point 4 (Mid-point of Operating Range)	80% MEL
Module Load Point 3	70% MEL
Module Load Point 2 (Lower of MRL+10% or Minimum Stable Operating Level)	MRL+10% or MSOL
Module Load Point 1 (Minimum regulating level)	MRL

ECP.A.5.8.7 The tests are divided into the following three types;

- (i) Frequency response compliance and volume tests as per ECP.A.5.8. Figure 1. These tests consist of frequency profile and ramp tests and adjustments to the target frequency setpoint as per ECP.5.8 Figure 3.
- (ii) System islanding and step response tests as shown by ECP.A.5.8. Figure 2.
- (iii) Frequency response tests in Limited Frequency Sensitive Mode (LFSM) to demonstrate LFSM-O and LFSM-U capability as shown by ECP.A.5.8 Figure 2.

ECP.A.5.8.8 There should be sufficient time allowed between tests for control systems to reach steady state. Where the diagram states 'HOLD' the

current injection should be maintained until the **Active Power (MW)** output of the **Synchronous Power Generating Module** or **CCGT Module** has stabilised. The frequency response capability test (see Figure 1) injection signal shall be returned to zero at the same rate at which it was applied. **NGET** may require repeat tests should the tests give unexpected results.

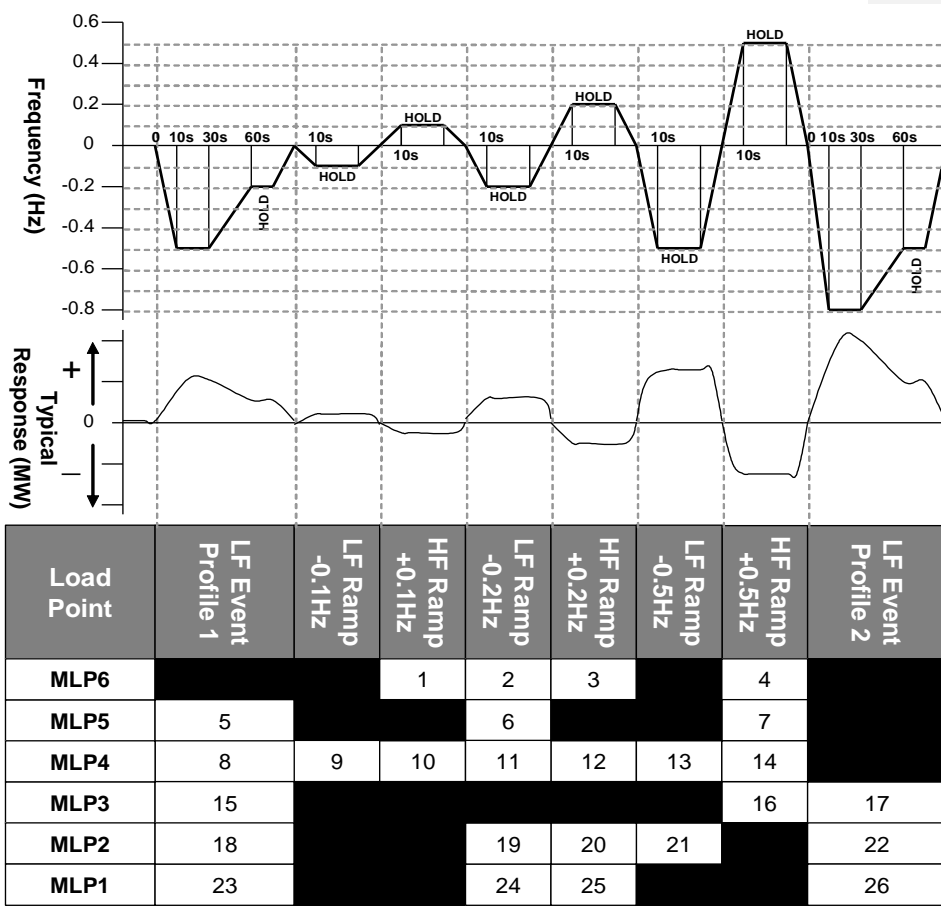

Figure 1: Frequency Response Capability FSM Ramp Response Tests

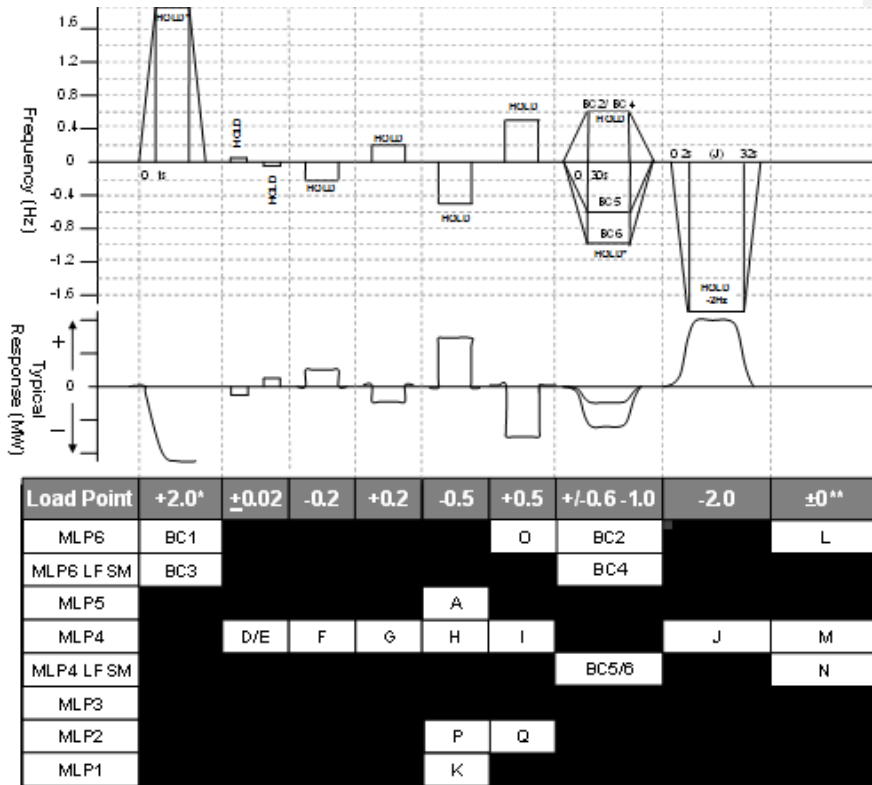

Figure 2: Frequency Response Capability LFSM-O, LFSM-U and FSM Step Response Tests

* This will generally be +2.0Hz unless an injection of this size causes a reduction in plant output that takes the operating point below **Minimum Stable Operating Level** in which case an appropriate injection should be calculated in accordance with the following:
 For example 0.9Hz is needed to take an initial output 65% to a final output of 20%. If the initial output was not 65% and the **Minimum Stable Operating Level** is not 20% then the injected step should be adjusted accordingly as shown in the example given below

Initial Output 65%
Minimum Stable Operating Level 20%
 Frequency Controller Droop 4%
 Frequency to be injected = $(0.65-0.20) \times 0.04 \times 50 = 0.9\text{Hz}$

** Tests L and M in Figure 2 shall be conducted if in this range of tests the system frequency feedback signal is replaced by the injection signal rather than the injection signal being added to the system frequency signal. The tests will consist of monitoring the **Synchronous Power Generating Module and CCGT Module in Frequency Sensitive Mode** during normal system frequency

variations without applying any injection. Test N in figure 2 shall be conducted in all cases. All three tests should be conducted for a period of at least 10 minutes.

ECP.A.5.8.9 The target frequency adjustment facility should be demonstrated from the normal control point within the range of 49.9Hz to 50.1Hz by step changes to the target frequency setpoint as indicated in ECP.A.5.8 Figure 3

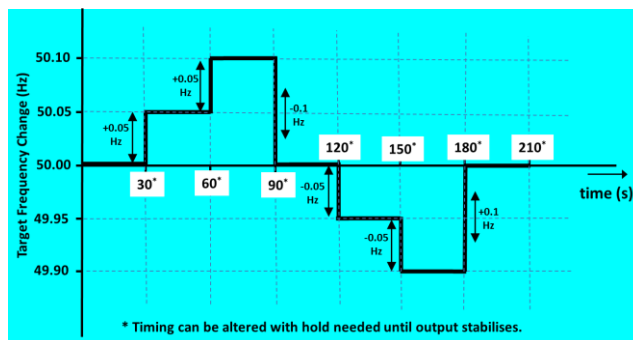

ECP.A.5.8 Figure 3 – Target Frequency setting changes

ECP.A.5.9 Compliance with ECC.6.3.3 Functionality Test

ECP.A.5.9.1 Where the plant design includes active control function or functions to deliver ECC.6.3.3 compliance, the **Generator** will propose and agree a test procedure with **NGET**, which will demonstrate how the **Synchronous Power Generating Module Active Power** output responds to changes in **System Frequency** and ambient conditions (e.g. by **Frequency** and temperature injection methods).

ECP.A.5.9.2 The **Generator** shall inform **NGET** if any load limiter control is additionally employed.

ECP.A.5.9.3 With Setpoint to the signals specified in ECP.A.4, **NGET** will agree with the **Generator** which additional control system parameters shall be monitored to demonstrate the functionality of ECC.6.3.3 compliance systems. Where **NGET** recording equipment is not used results shall be supplied to **NGET** in an electronic spreadsheet format

DRAFT

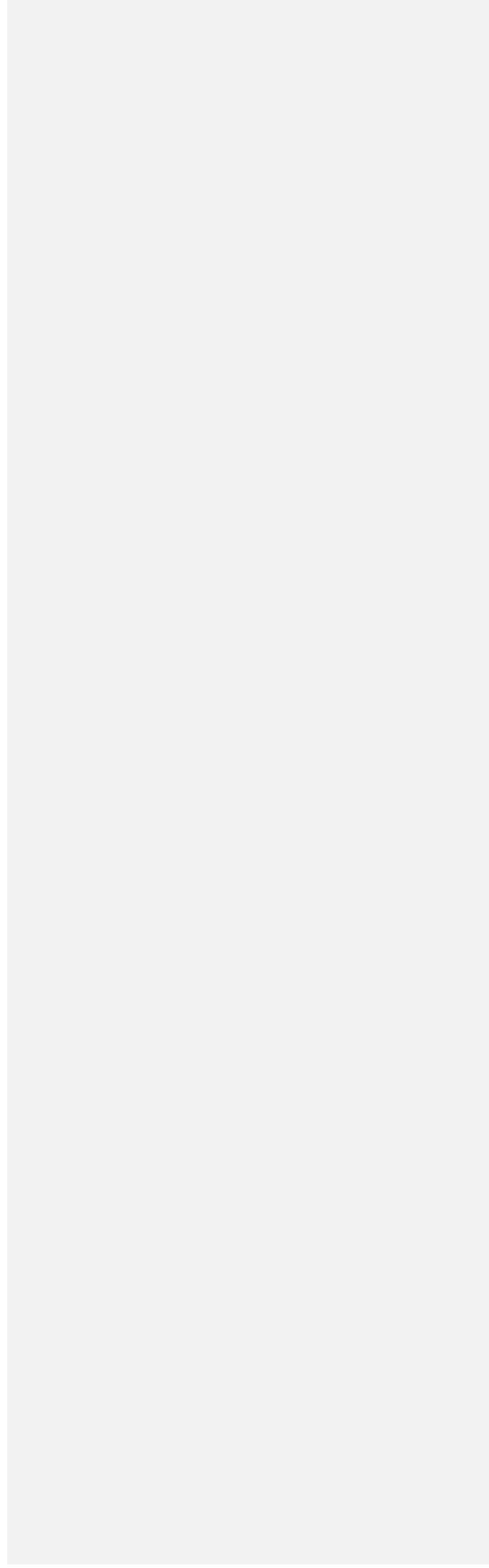

APPENDIX 6

COMPLIANCE TESTING OF POWER PARK MODULES

ECP.A.6.1 SCOPE

ECP.A.6.1.1 This Appendix outlines the general testing requirements for **Power Park Modules** and **OTSDUA** to demonstrate compliance with the relevant aspects of the **Grid Code, Ancillary Services Agreement** and **Bilateral Agreement**. The tests specified in this Appendix will normally be sufficient to demonstrate compliance however **NGET** may:

- i) agree an alternative set of tests provided **NGET** deem the alternative set of tests sufficient to demonstrate compliance with the **Grid Code, Ancillary Services Agreement** and **Bilateral Agreement**; and/or
- ii) require additional or alternative tests if information supplied to **NGET** during the compliance process suggests that the tests in this Appendix will not fully demonstrate compliance with the relevant section of the **Grid Code, Ancillary Services Agreement** or **Bilateral Agreement**; and/or
- iii) require additional tests if a **Power System Stabiliser** is fitted; and/or
- iv) agree a reduced set of tests if a relevant **Manufacturer's Data & Performance Report** has been submitted to and deemed to be appropriate by **NGET**; and/or
- v) agree a reduced set of tests for subsequent **Power Park Modules** or **OTSDUA** following successful completion of the first **Power Park Module** or **OTSDUA** tests in the case of a **Power Station** comprised of two or more **Power Park Modules** or **OTSDUA** which **NGET** reasonably considers to be identical.

If:

- (a) the tests performed pursuant to ECP.A.6.1.1(iv) do not replicate the results contained in the **Manufacturer's Data & Performance Report** or
- (b) the tests performed pursuant to ECP.A.6.1.1(v) in respect of subsequent **Power Park Modules** or **OTSDUA** do not replicate the full tests for the first **Power Park Module** or **OTSDUA**, or
- (c) any of the tests performed pursuant to ECP.A.6.1.1(iv) or ECP.A.6.1.1(v) do not fully demonstrate compliance with the relevant aspects of the **Grid Code, Ancillary Services Agreement** and / or **Bilateral Agreement**,

then notwithstanding the provisions above, the full testing requirements set out in this Appendix will be applied.

- ECP.A.6.1.2 The **Generator** is responsible for carrying out the tests set out in and in accordance with this Appendix and the **Generator** retains the responsibility for the safety of personnel and plant during the test. **NGET** will witness all of the tests outlined or agreed in relation to this Appendix unless **NGET** decides and notifies the **Generator** otherwise. Reactive Capability tests may be witnessed by **NGET** remotely from the **NGET** control centre. For all on site **NGET** witnessed tests the **Generator** must ensure suitable representatives from the **Generator** and / or **Power Park Module** manufacturer (if appropriate) and/or **OTSDUA** manufacturer (if appropriate) are available on site for the entire testing period. In all cases and in addition to any recording of signals conducted by **NGET** the **Generator** shall record all relevant test signals as outlined in ECP.A.4.
- ECP.A.6.1.3 In addition to the dynamic signals supplied in ECP.A.4 the **Generator** shall inform **NGET** of the following information prior to the commencement of the tests and any changes to the following, if any values change during the tests:
- (i) All relevant transformer tap numbers; and
 - (ii) Number of **Power Park Units** in operation
- ECP.A.6.1.4 The **Generator** shall submit a detailed schedule of tests to **NGET** in accordance with CP.6.3.1, and this Appendix.
- ECP.A.6.1.5 Prior to the testing of a **Power Park Module** or **OTSDUA** the **Generator** shall complete the **Integral Equipment Tests** procedure in accordance with OC.7.5
- ECP.A.6.1.6 Partial **Power Park Module** or **OTSDUA** testing as defined in ECP.A.6.2 and ECP.A.6.3 is to be completed at the appropriate stage in accordance with ECP.6, ECP6.4A, ECP6.4B.
- ECP.A.6.1.7 Full **Power Park Module** or **OTSDUA** testing as required by CP.7.2 is to be completed as defined in ECP.A.6.4 through to ECP.A.6.7
- ECP.A.6.1.8 Where **OTSDUW Arrangements** apply and prior to the **OTSUA Transfer Time** any relevant **OTSDUW Plant and Apparatus** shall be considered within the scope of testing described in this Appendix. Performance shall be assessed against the relevant Grid Code requirements for **OTSDUW Plant and Apparatus** at the **Interface Point** and other **Generator Plant and Apparatus** at the **Offshore Grid Entry Point**. This Appendix should be read accordingly.
- ECP.A.6.1.9 **NGET** will permit relaxation from the requirement ECP.A.6.2 to ECP.A.6.8 where an **Equipment Certificate** for the **Power Park Module** has been provided which details the characteristics from tests on a representative installation with the same equipment and settings and the performance of the **Power Park Module** can, in **NGET's** opinion, reasonably represent that of the installed **Power Park Module** at that site. For **Type B, Type C** and **Type D Power Park Modules** the relevant **Equipment Certificate** must be supplied in the **Power Generating Module Document** or **Users Data File structure** as applicable.

ECP.A.6.2 Pre 20% (or <50MW) Synchronised Power Park Module Basic Voltage Control Tests

ECP.A.6.2.1 Before 20% of the **Power Park Module** (or 50MW if less) has commissioned, either voltage control test ECP.A.6.5.6(i) or (ii) must be completed in accordance with ECP.6, ECP.6A or ECP.6B. In the case of an **Offshore Power Park Module** the test must be completed by the **Generator** undertaking **OTSDUW** or the **Offshore Transmission Licensee** under STCP19-5.

ECP.A.6.2.2 In the case of an **Offshore Power Park Module** which provides all or a portion of the **Reactive Power** capability as described in ECC.6.3.2.5.2 or ECP.6.3.2.6.3 and / or voltage control requirements as described in ECC.6.3.8.5 to enable an **Offshore Transmission Licensee** to meet the requirements of **STC** Section K, the **Generator** is required to cooperate with the **Offshore Transmission Licensee** to conduct the 20% voltage control test. The results in relation to the **Offshore Power Park Module** will be assessed against the requirements in the **Bilateral Agreement**.

ECP.A.6.3 Power Park Modules with Maximum Capacity \geq 100MW Pre 70% Power Park Module Tests

ECP.A.6.3.1 Before 70% but with at least 50% of the **Power Park Module** commissioned the following **Limited Frequency Sensitive** tests as detailed in ECP.A.6.6.2 must be completed.

- (a) BC3
- (b) BC4

ECP.A.6.4 Reactive Capability Test

ECP.A.6.4.1 This section details the procedure for demonstrating the reactive capability of an **Onshore Power Park Module** or an **Offshore Power Park Module** or **OTSDUA** which provides all or a portion of the **Reactive Power** capability as described in ECC.6.3.2.5.2 or ECP.6.3.2.6.3 as applicable (for the avoidance of doubt, an **Offshore Power Park Module** which does not provide part of the **Offshore Transmission Licensee Reactive Power** capability as described in ECC.6.3.2.5.1 and ECP.6.3.2.6.1 should complete the **Reactive Power** transfer / voltage control tests as per section ECP.A.6.8). These tests should be scheduled at a time where there are at least 95% of the **Power Park Units** within the **Power Park Module** in service. There should be sufficient MW resource forecasted in order to generate at least 85% of **Maximum Capacity** of the **Power Park Module**.

ECP.A.6.4.2 The tests shall be performed by modifying the voltage set-point of the voltage control scheme of the **Power Park Module** or **OTSDUA** by the amount necessary to demonstrate the required reactive range. This is to be conducted for the operating points and durations specified in ECP.A.6.4.5.

ECP.A.6.4.3 An **Embedded Generator** or **Embedded Generator** undertaking

OTSDUW should liaise with the relevant **Network Operator** to ensure the following tests will not have an adverse impact upon the **Network Operator's System** as per OC.7.5. In situations where the tests have an adverse impact upon the **Network Operator's System** **NGET** will only require demonstration within the acceptable limits of the **Network Operator**. For the avoidance of doubt, these tests do not negate the requirement to produce a complete **Power Park Module** or **OTSDUA** performance chart as specified in OC2.4.2.1

ECP.A.6.4.4 In the case where the **Reactive Power** metering point is not at the same location as the **Reactive Power** capability requirement, then an equivalent **Reactive Power** capability for the metering point shall be agreed between the **Generator** and **NGET**.

ECP.A.6.4.5 The following tests shall be completed:

- (i) Operation in excess of 60% **Maximum Capacity** and maximum continuous lagging **Reactive Power** for 30 minutes.
- (ii) Operation in excess of 60% **Maximum Capacity** and maximum continuous leading **Reactive Power** for 30 minutes.
- (iii) Operation at 50% **Maximum Capacity** and maximum continuous leading **Reactive Power** for 30 minutes.
- (iv) Operation at 20% **Maximum Capacity** and maximum continuous leading **Reactive Power** for 60 minutes.
- (v) Operation at 20% **Maximum Capacity** and maximum continuous lagging **Reactive Power** for 60 minutes.
- (vi) Operation at less than 20% **Maximum Capacity** and unity **Power Factor** for 5 minutes. This test only applies to systems which do not offer voltage control below 20% of **Maximum Capacity**.
- (vii) Operation at the lower of the **Minimum Stable Operating Level** or 0% **Maximum Capacity** and maximum continuous leading **Reactive Power** for 5 minutes. This test only applies to systems which offer voltage control below 20% and hence establishes actual capability rather than required capability.
- (viii) Operation at the lower of the **Minimum Stable Operating Level** or 0% **Maximum Capacity** and maximum continuous lagging **Reactive Power** for 5 minutes. This test only applies to systems which offer voltage control below 20% and hence establishes actual capability rather than required capability.

ECP.A.6.4.6 Within this ECP lagging **Reactive Power** is the export of **Reactive Power** from the **Power Park Module** to the **Total System** and leading **Reactive Power** is the import of **Reactive Power** from the **Total System** to the **Power Park Module** or **OTSDUA**.

ECP.A.6.5 Voltage Control Tests

- ECP.A.6.5.1** This section details the procedure for conducting voltage control tests on **Onshore Power Park Modules** or **OTSDUA** or an **Offshore Power Park Module** which provides all or a portion of the voltage control capability as described in ECC.6.3.8.5 (for the avoidance of doubt, **Offshore Power Park Modules** which do not provide part of the **Offshore Transmission Licensee** voltage control capability as described in CC6.3.8.5 should complete the **Reactive Power** transfer / voltage control tests as per section ECP.A.6.8). These tests should be scheduled at a time when there are at least 95% of the **Power Park Units** within the **Power Park Module** in service. There should be sufficient MW resource forecasted in order to generate at least 65% of **Maximum Capacity** of the **Onshore Power Park Module**. An **Embedded Generator** or **Embedded Generators** undertaking **OTSDUW** should also liaise with the relevant **Network Operator** to ensure all requirements covered in this section will not have a detrimental effect on the **Network Operator's System**.
- ECP.A.6.5.2** The voltage control system shall be perturbed with a series of step injections to the **Power Park Module** voltage Setpoint, and where possible, multiple up-stream transformer taps. In the case of an **Offshore Power Park Module** providing part of the **Offshore Transmission Licensee** voltage control capability this may require a series of step injections to the voltage Setpoint of the **Offshore Transmission Licensee** control system.
- ECP.A.6.5.3** For steps initiated using network tap changers the **Generator** will need to coordinate with **NGET** or the relevant **Network Operator** as appropriate. The time between transformer taps shall be at least 10 seconds as per ECP.A.6.5 Figure 1.
- ECP.A.6.5.4** For step injection into the **Power Park Module** or **OTSDUA** voltage Setpoint, steps of $\pm 1\%$ and $\pm 2\%$ (or larger if required by **NGET**) shall be applied to the voltage control system Setpoint summing junction. The injection shall be maintained for 10 seconds as per ECP.A.6.5 Figure 2.
- ECP.A.6.5.5** Where the voltage control system comprises of discretely switched plant and apparatus additional tests will be required to demonstrate that its performance is in accordance with **Grid Code** and **Bilateral Agreement** requirements.

ECP.A.6.5.6 Tests to be completed:

(i)

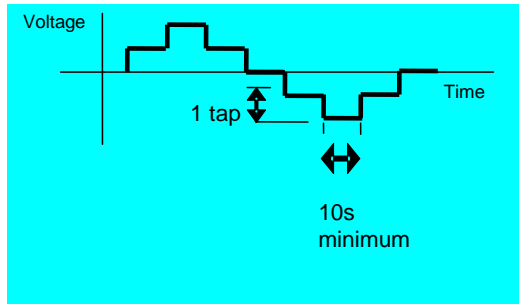

ECP.A.6.5 Figure 1 – Transformer tap sequence for voltage control tests

(ii)

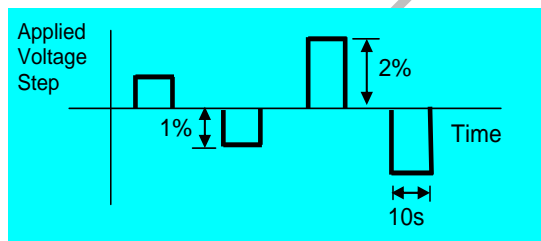

ECP.A.6.5 Figure 2 – Step injection sequence for voltage control tests

ECP.A.6.5.7 In the case of **OTSDUA** where the **Bilateral Agreement** specifies additional damping facilities additional testing to demonstrate these damping facilities may be required.

ECP.A.6.6 Frequency Response Tests

ECP.A.6.6.1 This section describes the procedure for performing frequency response testing on a **Power Park Module**. These tests should be scheduled at a time where there are at least 95% of the **Power Park Units** within the **Power Park Module** in service. There should be sufficient MW resource forecasted in order to generate at least 65% of **Maximum Capacity** of the **Power Park Module**.

ECP.A.6.6.2 The frequency controller shall be in **Frequency Sensitive Mode** or **Limited Frequency Sensitive Mode** as appropriate for each test. Simulated frequency deviation signals shall be injected into the frequency controller setpoint/feedback summing junction. If the injected frequency signal replaces rather than sums with the real system frequency signal then the additional tests outlined in ECP.A.6.6.6 shall be performed with the **Power Park Module** or **Power Park Unit** in normal **Frequency Sensitive Mode** monitoring actual system frequency, over a period of at least 10 minutes. The aim

of this additional test is to verify that the control system correctly measures the real system frequency for normal variations over a period of time.

ECP.A.6.6.3 In addition to the frequency response requirements it is necessary to demonstrate the **Power Park Module** ability to deliver a requested steady state power output which is not impacted by power source variation as per ECC.6.3.9. This test shall be conducted in **Limited Frequency Sensitive Mode** at a part-loaded output for a period of 10 minutes as per ECP.A.6.6.6.

Preliminary Frequency Response Testing

ECP.A.6.6.4 Prior to conducting the full set of tests as per ECP.A.6.6.6, **Generators** are required to conduct the preliminary set of tests below to confirm the frequency injection method is correct and the plant control performance is within expectation. The test numbers refer to Figure 1 below. The test should be conducted when sufficient MW resource is forecasted in order to generate at least 65% of **Maximum Capacity** of the **Power Park Module**. The following frequency injections shall be applied when operating at module load point 4.

Test No (Figure1)	Frequency Injection	Notes
8	<ul style="list-style-type: none"> Inject -0.5Hz frequency fall over 10 sec Hold for a further 20 sec At 30 sec from the start of the test, Inject a +0.3Hz frequency rise over 30 sec. Hold until conditions stabilise Remove the injected signal as a ramp over 10 seconds 	
13	<ul style="list-style-type: none"> Inject - 0.5Hz frequency fall over 10 sec Hold until conditions stabilise Remove the injected signal as a ramp over 10 seconds 	
14	<ul style="list-style-type: none"> Inject +0.5Hz frequency rise over 10 sec Hold until conditions stabilise Remove the injected signal as a ramp over 10 seconds 	
H	<ul style="list-style-type: none"> Inject - 0.5Hz frequency fall as a stepchange Hold until conditions stabilise Remove the injected signal as a stepchange 	
I	<ul style="list-style-type: none"> Inject +0.5Hz frequency rise as a stepchange Hold until conditions stabilise Remove the injected signal as a stepchange 	

ECP.A.6.6.5 The recorded results (e.g. Finj, MW and control signals) should be sampled at a minimum rate of 1 Hz to allow **NGET** to assess the plant performance from the initial transients (seconds) to the final steady state conditions (5-15 minutes depending on the plant design). This is not witnessed by **NGET**. The **Generator** shall supply the recordings including data to **NGET** in an electronic spreadsheet format. Results shall be legible, identifiable by labelling, and shall have appropriate scaling.

Full Frequency Response Testing Schedule Witnessed by NGET

ECP.A.6.6.6 The tests are to be conducted at a number of different Module Load Points (MLP). In the case of a **Power Park Module** the module load points are conducted as shown below unless agreed otherwise by **NGET**.

Module Load Point 6 (Maximum Export Limit)	100% MEL
Module Load Point 5	90% MEL
Module Load Point 4 (Mid point of Operating Range)	80% MEL
Module Load Point 3	MRL+20%
Module Load Point 2 Lower of MRL +10% or Minimum Stable Operating Level	MRL+10% or MSOL
Module Load Point 1 (Minimum regulating level)	MRL

ECP.A.6.6.7 The tests are divided into the following two types;

- (i) Frequency response compliance and volume tests as per ECP.A.6.6. Figure 1. These tests consist of frequency profile and ramp tests and adjustments to target frequency setpoint as per ECP.A.6.6 Figure 3.
- (ii) System islanding and step response tests as shown by ECP.A.6.6. Figure 2.
- (iii) Frequency response tests in **Limited Frequency Sensitive Mode (LFSM)** to demonstrate **LFSM-O** and **LFSM-U** capability as shown by ECP.A.6.6 Figure 2.

ECP.A.6.6.8 There should be sufficient time allowed between tests for control systems to reach steady state (depending on available power resource). Where the diagram states 'HOLD' the current injection should be maintained until the **Active Power** (MW) output of the **Power Park Module** has stabilised. All frequency response tests should be removed over the same timescale for which they were applied. **NGET** may require repeat tests should the response volume be affected by the available power, or if tests give unexpected results.

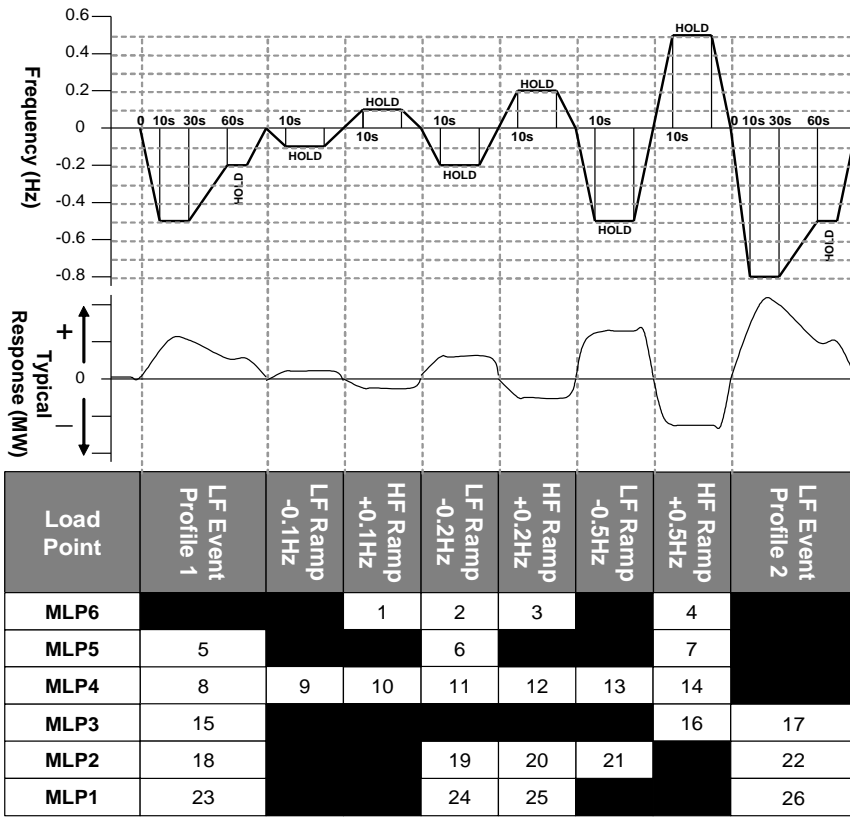

ECP.A.6.6. Figure 1 – Frequency Response Capability FSM Ramp Response tests

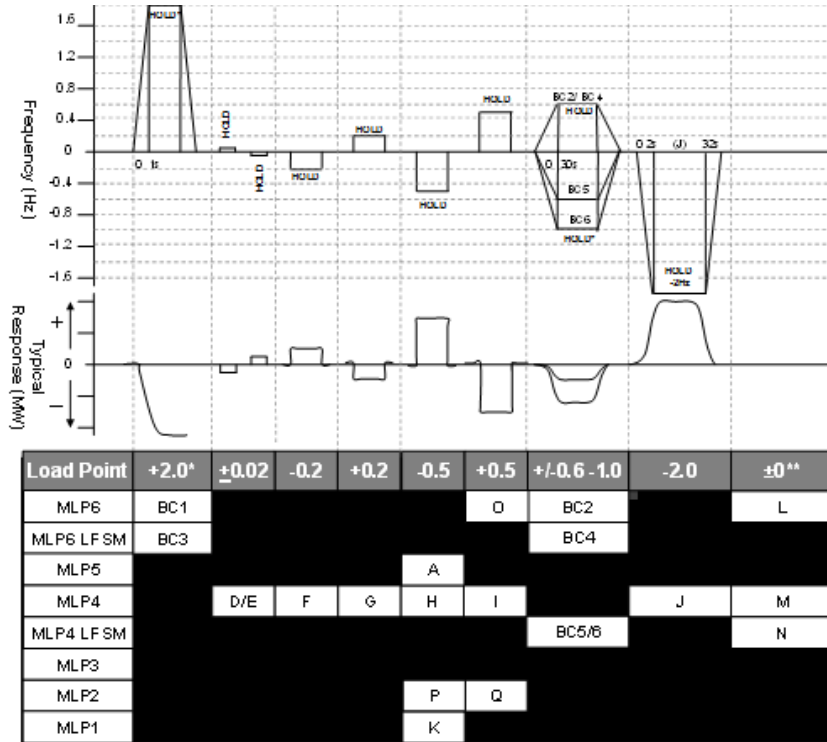

ECP.A.6.6. Figure 2 – Frequency Response Capability LFSM-O, LFSM-U, FSM Step Response tests

* This will generally be +2.0Hz unless an injection of this size causes a reduction in plant output that takes the operating point below **Minimum Stable Operating Level** in which case an appropriate injection should be calculated in accordance with the following:
 For example 0.9Hz is needed to take an initial output 65% to a final output of 20%. If the initial output was not 65% and the **Minimum Stable Operating Level** is not 20% then the injected step should be adjusted accordingly as shown in the example given below

Initial Output 65%
Minimum Stable Operating Level 20%
 Frequency Controller Droop 4%
 Frequency to be injected = $(0.65-0.20) \times 0.04 \times 50 = 0.9\text{Hz}$

** Tests L and M in Figure 2 shall be conducted if in this range of tests the system frequency feedback signal is replaced by the injection signal rather than the injection signal being added to the system frequency signal. The tests will consist of monitoring the **Power Park Module** in **Frequency Sensitive Mode** during normal system frequency variations without applying any injection. Test N in Figure 2 shall be conducted in all cases. All three tests should be conducted for a period of at least 10 minutes.

ECP.A.6.6.9 The target frequency adjustment facility should be demonstrated from the normal control point within the range of 49.9Hz to 50.1Hz by step changes to the target frequency setpoint as indicated in ECP.A.6.6 Figure 3.

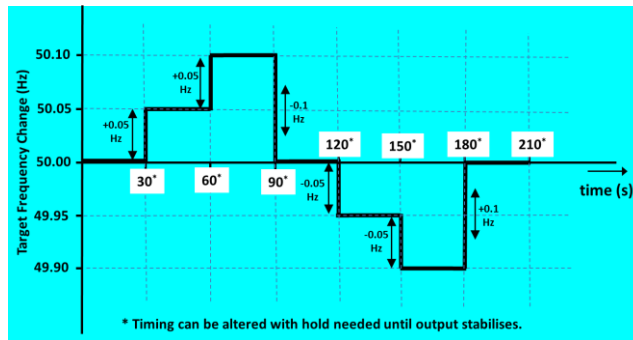

ECP.A.6.6. Figure 3 – Target Frequency setting changes

ECP.A.6.7 Fault Ride Through Testing

ECP.A.6.7.1 This section describes the procedure for conducting fault ride through tests on a single **Power Park Unit** as required by ECP.7.2.2(d).

ECP.A.6.7.2 The test circuit will utilise the full **Power Park Unit** with no exclusions (e.g. in the case of a wind turbine it would include the full wind turbine structure) and shall be conducted with sufficient resource available to produce at least 95% of the **Maximum Capacity** of the **Power Park Unit**. The test will comprise of a number of controlled short circuits applied to a test network to which the **Power Park Unit** is connected, typically comprising of the **Power Park Unit** transformer and a test impedance to shield the connected network from voltage dips at the **Power Park Unit** terminals.

ECP.A.6.7.3 In each case the tests should demonstrate the minimum voltage at the **Power Park Unit** terminals or **High Voltage** side of the **Power Park Unit** transformer which the **Power Park Unit** can withstand for the length of time specified in ECP.A.6.7.5. Any test results provided to **NGET** should contain sufficient data pre and post fault in order to determine steady state values of all signals, and the power recovery timescales.

ECP.A.6.7.4 In addition to the signals outlined in ECP.A.4.2. the following signals from either the **Power Park Unit** terminals or **High Voltage** side of the **Power Park Unit** transformer should be provided for this test only:

- (i) Phase voltages
- (ii) Positive phase sequence and negative phase sequence voltages
- (iii) Phase currents
- (iv) Positive phase sequence and negative phase sequence currents

- (v) Estimate of **Power Park Unit** negative phase sequence impedance
- (vi) MW – **Active Power** at the power generating module.
- (vii) MVar – **Reactive Power** at the power generating module.
- (viii) Mechanical Rotor Speed
- (ix) Real / reactive, current / power Setpoint as appropriate
- (x) Fault ride through protection operation (e.g. a crowbar in the case of a doubly fed induction generator)
- (xi) Any other signals relevant to the control action of the fault ride through control deemed applicable for model validation.

At a suitable frequency rate for fault ride through tests as agreed with **NGET**.

ECP.A.6.7.5 The tests should be conducted for the times and fault types indicated in ECC.6.3.15 as applicable.

ECP.A.6.8 **Reactive Power Transfer / Voltage Control Tests for Offshore Power Park Modules**

ECP.A.6.8.1 In the case of an **Offshore Power Park Module** which provides all or a portion of the **Reactive Power** capability as described in ECP.6.3.2.5.2 or ECP.6.3.6.3 and / or voltage control requirements as described in ECC.6.3.8.5 to enable an **Offshore Transmission Licensee** to meet the requirements of **STC** Section K, the testing, will comprise of the entire control system responding to changes at the onshore **Interface Point**. Therefore the tests in this section ECP.A.6.8 will not apply. The **Generator** shall cooperate with the relevant **Offshore Transmission Licensee** to facilitate these tests as required by **NGET**. The testing may be combined with testing of the corresponding **Offshore Transmission Licensee** requirements under the **STC**. The results in relation to the **Offshore Power Park Module** will be assessed against the requirements in the **Bilateral Agreement**.

ECP.A.6.8.2 In the case of an **Offshore Power Park Module** which does not provide part of the **Offshore Transmission Licensee Reactive Power** capability the following procedure for conducting **Reactive Power** transfer control tests on **Offshore Power Park Modules** and / or voltage control system as per CC6.3.2(e)(i) and CC6.3.2(e)(ii) apply. These tests should be carried out prior to 20% of the **Power Park Units** within the **Offshore Power Park Module** being synchronised, and again when at least 95% of the **Power Park Units** within the **Offshore Power Park Module** in service. There should be sufficient power resource forecast to generate at least 85% of the **Maximum Capacity** of the **Offshore Power Park Module**.

ECP.A.6.8.3 The **Reactive Power** control system shall be perturbed by a series of system voltage changes and changes to the **Active Power** output of the **Offshore Power Park Module**.

ECP.A.6.8.4 System voltage changes should be created by a series of multiple upstream transformer taps. The **Generator** should coordinate with **NGET** or the relevant **Network Operator** in order to conduct the

required tests. The time between transformer taps should be at least 10 seconds as per ECP.A.6.8 Figure 1.

ECP.A.6.8.5 The active power output of the **Offshore Power Park Module** should be varied by applying a sufficiently large step to the frequency controller Setpoint/feedback summing junction to cause a 10% change in output of the **Maximum Capacity** of the **Offshore Power Park Module** in a time not exceeding 10 seconds. This test does not need to be conducted provided that the frequency response tests as outlined in ECP.A.6.6 are completed.

ECP.A.6.8.6 The following diagrams illustrate the tests to be completed:

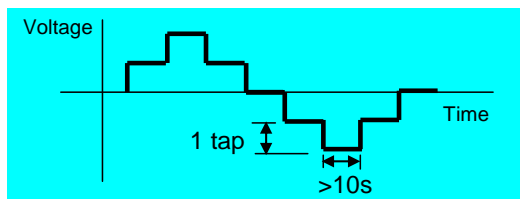

ECP.A.6.8 Figure 1 – Transformer tap sequence for reactive transfer tests

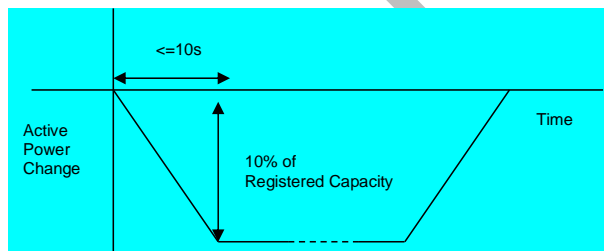

ECP.A.6.8 Figure 2 – Active Power ramp for reactive transfer tests

APPENDIX 7

COMPLIANCE TESTING FOR HVDC EQUIPMENT

ECP.A.7.1 SCOPE

ECP.A.7.1.1 This Appendix outlines the general testing requirements for **HVDC System Owners** to demonstrate compliance with the relevant aspects of the **Grid Code, Ancillary Services Agreement** and **Bilateral Agreement**. The tests specified in this Appendix will normally be sufficient to demonstrate compliance however **NGET** may:

- i) agree an alternative set of tests provided **NGET** deem the alternative set of tests sufficient to demonstrate compliance with the **Grid Code, Ancillary Services Agreement** and **Bilateral Agreement**; and/or
- ii) require additional or alternative tests if information supplied to **NGET** during the compliance process suggests that the tests in this Appendix will not fully demonstrate compliance with the relevant section of the **Grid Code, Ancillary Services Agreement** or **Bilateral Agreement**; and/or
- iii) require additional tests if control functions to improve damping of power system oscillations and/or subsynchronous resonance torsional oscillations required by the **Bilateral Agreement** or included in the control scheme and active; and/or
- iv) agree a reduced set of tests for subsequent **HVDC Equipment** following successful completion of the first **HVDC Equipment** tests in the case of **aan** installation comprising of two or more **HVDC Systems** or **DC Connected Power Park Modules** which **NGET** reasonably considers to be identical.

If:

- (a) the tests performed pursuant to ECP.A.7.1.1(iv) in respect of subsequent **HVDC Systems** or **DC Connected Power Park Modules** do not replicate the full tests for the first **HVDC Equipment** , or
- (b) any of the tests performed pursuant to ECP.A.7.1.1(iv) do not fully demonstrate compliance with the relevant aspects of the **Grid Code, Ancillary Services Agreement** and / or **Bilateral**

ECP.A.7.1.2 The **HVDC System Owner** is responsible for carrying out the tests set out in and in accordance with this Appendix and the **HVDC System Owner** retains the responsibility for the safety of personnel and plant during the test. The **HVDC System Owner** is responsible for ensuring that suitable arrangements are in place with the **Externally Interconnected System Operator** to facilitate testing. **NGET** will witness all of the tests outlined or agreed in relation to this Appendix unless **NGET** decides and notifies the **HVDC System Owner** otherwise. Reactive Capability tests if required, may be witnessed by **NGET** remotely from the **NGET** control centre. For all on site **NGET**

witnessed tests the **HVDC System Owner** must ensure suitable representatives from the **HVDC System Owner** and / or **HVDC Equipment** manufacturer (if appropriate) are available on site for the entire testing period. In all cases and in addition to any recording of signals conducted by **NGET** the **HVDC System Owner** shall record all relevant test signals as outlined in ECP.A.4.

ECP.A.7.1.3 In addition to the dynamic signals supplied in ECP.A.4 the **HVDC System Owner** shall inform **NGET** of the following information prior to the commencement of the tests and any changes to the following, if any values change during the tests:

(i) All relevant transformer tap numbers.

ECP.A.7.1.4 The **HVDC System Owner** shall submit a detailed schedule of tests to **NGET** in accordance with CP.6.3.1, and this Appendix.

ECP.A.7.1.5 Prior to the testing of **HVDC Equipment** the **HVDC System Owner** shall complete the **Integral Equipment Tests** procedure in accordance with OC.7.5

ECP.A.7.1.6 Full **HVDC Equipment** testing as required by ECP.7.2 is to be completed as defined in ECP.A.7.2 through to ECP.A.7.5

ECP.A.7.1.7 **NGET** will permit relaxation from the requirement ECP.A.7.2 to ECP.A.7.5 where an **Equipment Certificate** for **HVDC Equipment** has been provided which details the characteristics from tests on a representative installation with the same equipment and settings and the performance of the **HVDC Equipment** can, in **NGET's** opinion, reasonably represent that of the installed **HVDC Equipment** at that site. The relevant **Equipment Certificate** must be supplied in the **Users Data File structure**.

ECP.A.7.2 **Reactive Capability Test**

ECP.A.7.2.1 This section details the procedure for demonstrating the reactive capability of **HVDC Equipment**. These tests should be scheduled at a time where there are sufficient MW resource forecasted in order to import and export full **Maximum Capacity** of the **HVDC Equipment**.

ECP.A.7.2.2 The tests shall be performed by modifying the voltage set-point of the voltage control scheme of the **HVDC Equipment** by the amount necessary to demonstrate the required reactive range. This is to be conducted for the operating points and durations specified in ECP.A.7.2.5.

ECP.A.7.2.3 **Embedded HVDC System Owners** should liaise with the relevant **Network Operator** to ensure the following tests will not have an adverse impact upon the **Network Operator's System** as per OC.7.5. In situations where the tests have an adverse impact upon the **Network Operator's System** **NGET** will only require demonstration within the acceptable limits of the **Network Operator**. For the avoidance of doubt, these tests do not negate the requirement to produce a complete **HVDC Equipment** performance chart as specified in OC2.4.2.1

ECP.A.7.2.4 In the case where the **Reactive Power** metering point is not at the same location as the **Reactive Power** capability requirement, then an equivalent **Reactive Power** capability for the metering point shall be agreed between the **HVDC System Owner** and **NGET**.

ECP.A.7.2.5 The following tests shall be completed for both importing and exporting of Active Power for a **DC Converter**:

- (i) Operation at **Maximum Capacity** and maximum continuous lagging **Reactive Power** for 60 minutes.
- (ii) Operation at **Maximum Capacity** and maximum continuous leading **Reactive Power** for 60 minutes.
- (iii) Operation at 50% **Maximum Capacity** and maximum continuous leading **Reactive Power** for 60 minutes.
- (iv) Operation at 50% **Maximum Capacity** and maximum continuous lagging **Reactive Power** for 60 minutes.
- (v) Operation at **Minimum Capacity** and maximum continuous leading **Reactive Power** for 60 minutes.
- (vi) Operation at **Minimum Capacity** and maximum continuous lagging **Reactive Power** for 60 minutes.

ECP.A.7.2.6 For the avoidance of doubt, lagging **Reactive Power** is the export of **Reactive Power** from the **HVDC Equipment** to the **Total System** and leading **Reactive Power** is the import of **Reactive Power** from the **Total System** to the **HVDC Equipment**.

ECP.A.7.3 Not Used

ECP.A.7.4 Voltage Control Tests

ECP.A.7.4.1 This section details the procedure for conducting voltage control tests on **HVDC Equipment**. These tests should be scheduled at a time where there are sufficient MW resource in order to import and export **Maximum Capacity** of the **HVDC Equipment**. An **Embedded HVDC System Owner** should also liaise with the relevant **Network Operator** to ensure all requirements covered in this section will not have a detrimental effect on the **Network Operator's System**.

ECP.A.7.4.2 The voltage control system shall be perturbed with a series of step injections to the **HVDC Equipment** voltage Setpoint, and where possible, multiple up-stream transformer taps.

ECP.A.7.4.3 For steps initiated using network tap changers the **HVDC System Owner** will need to coordinate with **NGET** or the relevant **Network Operator** as appropriate. The time between transformer taps shall be at least 10 seconds as per ECP.A.7.4 Figure 1.

ECP.A.7.4.4 For step injection into the **HVDC Equipment** voltage Setpoint, steps of $\pm 1\%$ and $\pm 2\%$ shall be applied to the voltage control system Setpoint summing junction. The injection shall be maintained for 10 seconds as per ECP.A.7.4 Figure 2.

ECP.A.7.4.5 Where the voltage control system comprises of discretely switched plant and apparatus additional tests will be required to demonstrate that its performance is in accordance with **Grid Code** and **Bilateral Agreement** requirements.

ECP.A.7.4.6 Tests to be completed:

(i)

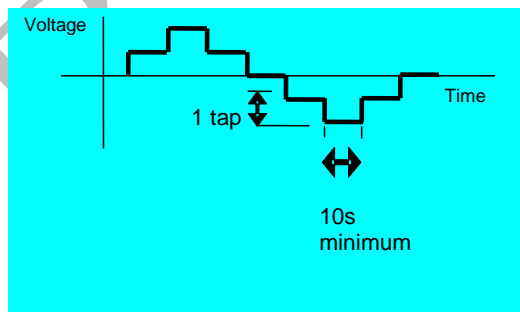

ECP.A.7.4 Figure 1 – Transformer tap sequence for voltage control tests

(ii)

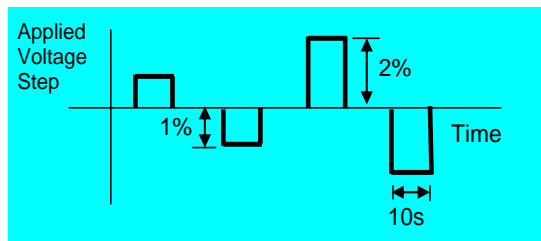

ECP.A.7.4 Figure 2 – Step injection sequence for voltage control tests

ECP.A.7.5 Frequency Response Tests

ECP.A.7.5.1 This section describes the procedure for performing frequency response testing on **HVDC Equipment**. These tests should be scheduled at a time where there are sufficient MW resource in order to import and export full **Maximum Capacity** of the **HVDC Equipment**. The **HVDC System Owner** is responsible for ensuring that suitable arrangements are in place with the **Externally Interconnected System Operator** to facilitate the active power changes required by these tests

ECP.A.7.5.2 The frequency controller shall be in **Frequency Sensitive Mode** or **Limited Frequency Sensitive Mode** as appropriate for each test. Simulated frequency deviation signals shall be injected into the frequency controller Setpoint/feedback summing junction. If the injected frequency signal replaces rather than sums with the real system frequency signal then the additional tests outlined in ECP.A.7.5.6 shall be performed with the **HVDC Equipment** in normal **Frequency Sensitive Mode** monitoring actual system frequency, over a period of at least 10 minutes. The aim of this additional test is to verify that the control system correctly measures the real system frequency for normal variations over a period of time.

ECP.A.7.5.3 In addition to the frequency response requirements it is necessary to demonstrate the **HVDC Equipment** ability to deliver a requested steady state power output which is not impacted by power source variation as per ECC.6.3.9. This test shall be conducted in **Limited Frequency Sensitive Mode** at a part-loaded output for a period of 10 minutes as per ECP.A.7.5.6.

Preliminary Frequency Response Testing

ECP.A.7.5.4 Prior to conducting the full set of tests as per ECP.A.7.5.6, **HVDC System Owners** are required to conduct a preliminary set of tests below to confirm the frequency injection method is correct and the plant control performance is within expectation. The test numbers refer to Figure 1 below. These tests should be scheduled at a time where there are sufficient MW resource in order to export full

Maximum Capacity from the HVDC Equipment . The following frequency injections shall be applied when operating at module load point 4.

DRAFT

Test No (Figure1)	Frequency Injection	Notes
8	<ul style="list-style-type: none"> Inject -0.5Hz frequency fall over 10 sec Hold for a further 20 sec At 30 sec from the start of the test, Inject a +0.3Hz frequency rise over 30 sec. Hold until conditions stabilise Remove the injected signal as a ramp over 10 seconds 	
13	<ul style="list-style-type: none"> Inject - 0.5Hz frequency fall over 10 sec Hold until conditions stabilise Remove the injected signal as a ramp over 10 seconds 	
14	<ul style="list-style-type: none"> Inject +0.5Hz frequency rise over 10 sec Hold until conditions stabilise Remove the injected signal as a ramp over 10 seconds 	
H	<ul style="list-style-type: none"> Inject - 0.5Hz frequency fall as a stepchange Hold until conditions stabilise Remove the injected signal as a stepchange 	
I	<ul style="list-style-type: none"> Inject +0.5Hz frequency rise as a stepchange Hold until conditions stabilise Remove the injected signal as a stepchange 	

ECP.A.7.5.5 The recorded results (e.g. Finj, MW and control signals) should be sampled at a minimum rate of 1 Hz to allow NGET to assess the plant performance from the initial transients (seconds) to the final steady state conditions (5-15 minutes depending on the plant design). This is not witnessed by NGET. The HVDC System Owner shall supply the recordings including data to NGET in an electronic spreadsheet format. Results shall be legible, identifiable by labelling, and shall have appropriate scaling.

Full Frequency Response Testing Schedule Witnessed by NGET

ECP.A.7.5.6 The tests are to be conducted at a number of different Module Load Points (MLP). In the case of HVDC Equipment the load points are conducted as shown below unless agreed otherwise by NGET.

Module Load Point 6 (Maximum Export Limit)	100% MEL
Module Load Point 5	90% MEL
Module Load Point 4 (Mid point of Operating Range)	80% MEL
Module Load Point 3	MRL+20%
Module Load Point 2	MRL+10%
Module Load Point 1 (Minimum regulating level)	MRL

ECP.A.7.5.7 The tests are divided into the following two types;

- (i) Frequency response compliance and volume tests as per ECP.A.7.5. Figure 1. These tests consist of frequency profile and ramp tests and adjustments to target frequency setpoint as per ECP.A.7.5 Figure 3
- (ii) System islanding and step response tests as shown by ECP.A.7.5 Figure 2

ECP.A.7.5. Fig 1 and 2 are shown for the Importing of Active Power, simulated frequency polarity should be reversed when exporting Active Power.

ECP.A.7.5.8 There should be sufficient time allowed between tests for control systems to reach steady state (depending on available power resource). Where the diagram states 'HOLD' the current injection should be maintained until the **Active Power** (MW) output of the **HVDC Equipment** has stabilised. All frequency response tests should be removed over the same timescale for which they were applied. **NGET** may require repeat tests should the response volume be affected by the available power, or if tests give unexpected results.

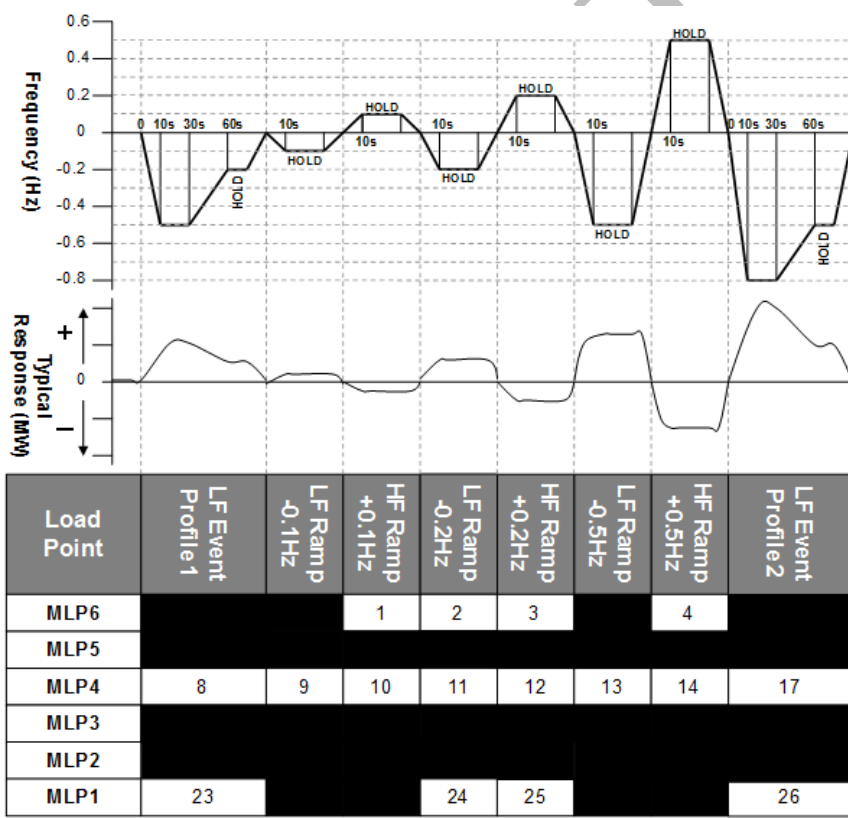

ECP.A.7.5. Figure 1 – Frequency Response Capability FSM Ramp Response tests

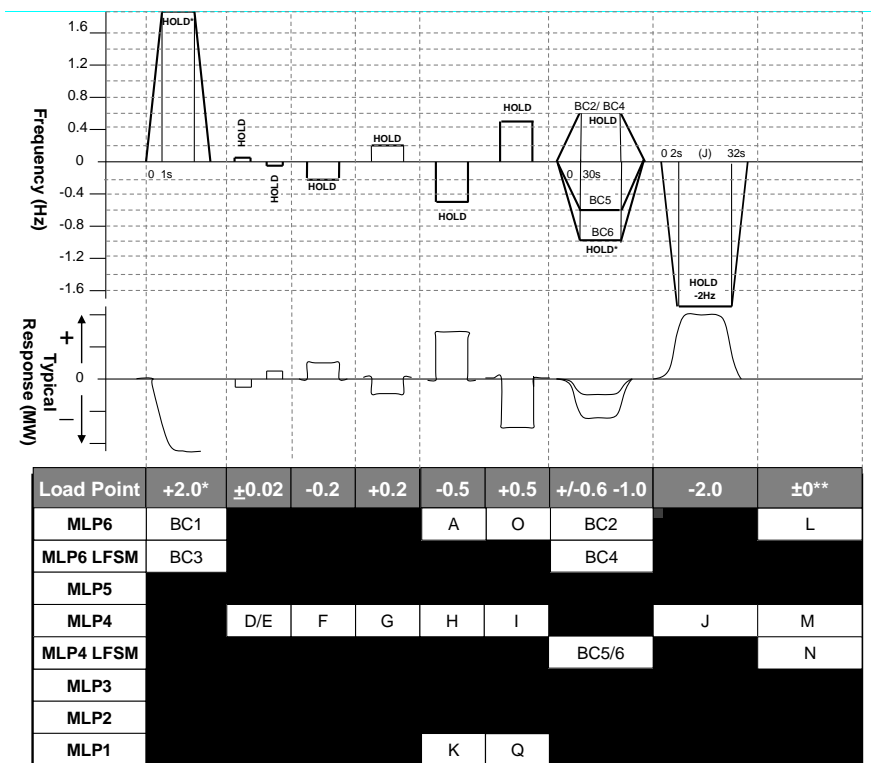

ECP.A.7.5. Figure 2 – Frequency Response Capability LFSM-O, LFSM-U, FSM Step Response tests

* This will generally be +2.0Hz unless an injection of this size causes a reduction in plant output that takes the operating point below **Minimum Capacity** in which case an appropriate injection should be calculated in accordance with the following:

For example 0.9Hz is needed to take an initial output 65% to a final output of 20%. If the initial output was not 65% and the **Minimum Capacity** is not 20% then the injected step should be adjusted accordingly as shown in the example given below

Initial Output	65%
Minimum Capacity	20%
Frequency Controller Droop	4%
Frequency to be injected =	$(0.65-0.20) \times 0.04 \times 50 = 0.9\text{Hz}$

** Tests L and M in Figure 2 shall be conducted if in this range of tests the system frequency feedback signal is replaced by the injection signal rather than the injection signal being added to the system frequency signal. The tests will consist of monitoring the **HVDC Equipment in Frequency Sensitive Mode** during normal system frequency variations without applying any injection. Test N in Figure 2 shall be conducted in all cases. All three tests should be conducted for

a period of at least 10 minutes.

ECP.A.7.5.9 The target frequency adjustment facility should be demonstrated from the normal control point within the range of 49.9Hz to 50.1Hz by step changes to the target frequency setpoint as indicated in ECP.A.7.5 Figure 3.

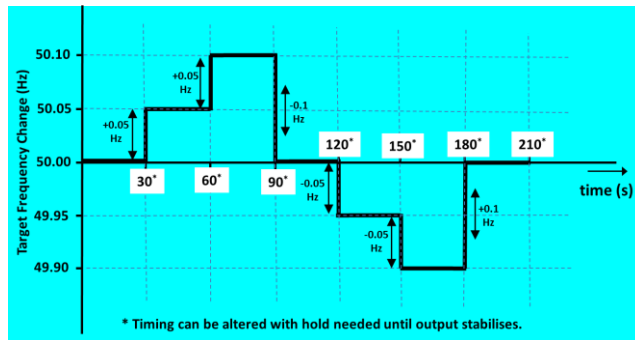

ECP.A.7.5. Figure 3 – Target Frequency setting changes

APPENDIX 8
SIMULATION STUDIES AND COMPLIANCE TESTING FOR NETWORK
OPERATORS AND NON-EMBEDDED CUSTOMERS PLANT AND APPARATUS

ECP.A.8.1 Compliance testing for disconnection and reconnection of Network Operator's Plant and Apparatus

ECP.A.8.1.1 **Network Operators** shall comply with the following applicable requirements in respect of **EU Grid Supply Points**:

- (i) Demand disconnection schemes;
- (ii) Synchronising; and/or
- (iii) low frequency demand disconnection;

Formatted: Font: Bold

Formatted: List Paragraph, Numbered + Level: 1 + Numbering Style: i, ii, iii, ... + Start at: 1 + Alignment: Left + Aligned at: 2.54 cm + Indent at: 3.81 cm

ECP.A.8.1.2 The requirements for demand disconnection, other than low frequency demand disconnection, are pursuant to the requirements of the **Bilateral Agreement**. Any requirements for testing shall be agreed with the **User** where such requirements are applicable.

Formatted: Font: Bold

Formatted: Font: Bold

Formatted: Font: Not Bold

ECP.A.8.1.3 The requirements for synchronising (where applicable) shall be pursuant to the requirements of the **Bilateral Agreement** and ECC.6.2.3.10. Any requirements for testing (as applicable) shall be agreed with the **User** and carried out during the commissioning process.

Formatted: Font: Not Bold

Formatted: Font: Not Bold

ECP.A.8.1.4 **Network Operators** who are **EU Code Users** must demonstrate compliance with the low frequency demand disconnection requirements of ECC.6.4.3, ECC.A.5 and OC.6.6 for their entire distribution **System**.

Formatted: Indent: Left: 0 cm, First line: 0 cm

Formatted: Font: Bold

Formatted: Font: Bold

ECP.A.8.1.5 An equipment certificate may be submitted to **NGET** instead of part of the tests provided for in ECP.A.8.1.1.

Formatted: Indent: Left: 0 cm, First line: 0 cm

ECP.A.8.2 Compliance testing for operational metering at EU Grid Supply Points

ECP.A.8.2.1 The requirements for operational metering (where required) shall be pursuant to the requirements of the **Bilateral Agreement** and ECC.6.5.6. Any applicable requirements for testing shall be agreed with the **User** and carried out during the commissioning process. An **Equipment Certificate** may be used for this purpose where agreed with **NGET**.

Formatted: Font: Bold

Formatted: Font: Bold

ECP.A.8.3 Compliance testing for disconnection and reconnection of Non-Embedded Customers Plant and Apparatus

ECP.A.8.3.1 **Non-Embedded Customers** shall comply with the following requirements where applicable:

- (i) Demand disconnection schemes;
- (ii) Synchronising; and/or
- (iii) low frequency demand disconnection;

Formatted: Numbered + Level: 1 + Numbering Style: i, ii, iii, ... + Start at: 1 + Alignment: Left + Aligned at: 2.54 cm + Indent at: 3.81 cm

ECP.A.8.3.2 The requirements for demand disconnection, other than low frequency demand disconnection, are pursuant to the requirements of the

Bilateral Agreement. Any requirements for testing shall be agreed with the **User**.

ECP.A.8.3.3 The requirements for synchronising (where applicable) shall be pursuant to the requirements of the **Bilateral Agreement** and ECC.6.2.3.10. Any requirements for testing (as applicable) shall be agreed with the **User** and carried out during the commissioning process.

ECP.A.8.3.4 **Non-Embedded Customers** who are **EU Code Users** must demonstrate compliance with the low frequency demand disconnection requirements of ECC.6.4.3, ECC.A.5 and OC.6.6 of their **System**.

ECP.A.8.3.5 An equipment certificate may be submitted to **NGET** instead of part of the tests provided for in ECP.A.8.3.1.

ECP.A.8.4 Compliance testing for operational metering on Non-Embedded Customers Plant and Apparatus

ECP.A.8.4.1 The requirements for operational metering (where required)) shall be pursuant to the requirements of the **Bilateral Agreement** and ECC.6.5.6. Any applicable requirements for testing shall be agreed with the **User** and carried out during the commissioning process. An **Equipment Certificate** may be used for this purpose where agreed with **NGET**.

ECP.A.8.5 Common Provisions on Compliance Simulations

ECP.A.8.5.1 **Users** are required to provide simulation studies or equivalent information to the satisfaction of **NGET** in the following circumstances.

- (i) a new connection to the **Transmission System** is required forming part of an **EU Grid Supply Point**;
- (ii) a **Substantial Modification** takes place at an **EU Grid Supply Point**
- (iii) **NGET** becomes aware of a potential non-compliance by the **Network Operator** or **Non-Embedded Customer** at an **EU Grid Supply Point**.

ECP.A.8.5.2 Notwithstanding the requirements of ECP.A.8.5.1, **NGET** shall be entitled to:-

- (a) Allow the **Network Operator** or **Non-Embedded Customer** to carry out an alternative set of simulations (or equivalent information) provided that they demonstrate that the **Network Operators** or **Non-Embedded Customers** **Plant and Apparatus** is capable of satisfying the applicable requirements of the **Data Registration Code**.
- (b) Require the **Network Operator** or **Non-Embedded Customer** to carry out additional or alternative simulations (or equivalent

Formatted: Font: Not Bold

Formatted: Font: Bold

Formatted: Indent: Left: 0 cm, First line: 0 cm

Formatted: Font: (Default) Arial

Formatted: Font: (Default) Arial

Formatted: Font: (Default) Arial

Formatted: Font: (Default) Arial

Formatted: Font: Not Bold

Formatted: List Paragraph, Numbered + Level: 1 + Numbering Style: i, ii, iii, ... + Start at: 1 + Alignment: Left + Aligned at: 2.29 cm + Indent at: 3.56 cm

Formatted: Font: Bold

Formatted: Font: Not Bold

Formatted: Font: Bold, Not Highlight

Formatted: List Paragraph, Numbered + Level: 1 + Numbering Style: i, ii, iii, ... + Start at: 1 + Alignment: Left + Aligned at: 2.29 cm + Indent at: 3.56 cm, Tab stops: Not at 2.29 cm + 3.56 cm + 4.83 cm

Formatted: Not Highlight

Formatted: Font: Not Bold

Formatted: Font: Not Bold

Formatted: Font: (Default) Arial

Formatted: Font: (Default) Arial

Formatted: Font: (Default) Arial

Formatted: Font: (Default) Arial

Formatted: Font: (Default) Arial

Formatted: Font: (Default) Arial

Formatted: Font: (Default) Arial

Formatted: Font: (Default) Arial

Formatted: Font: (Default) Arial

information) to those specified in ECP.A.8.5.1 where they would otherwise be insufficient to demonstrate compliance.

(c) NGET may check that the Network Operator or Non-Embedded Customer complies with the requirements of the Grid Code by carrying out its own compliance simulations based on the simulation reports, models and test measurements submitted under the Data Registration Code.

ECP.A.8.5.3 NGET will supply (under PC.A.8) upon request to the Network Operator or Non-Embedded Customer, data to enable the Network Operator or Non-Embedded Customer, to carry out the required simulations or supply the equivalent information required under the Data Registration Code.

ECP.A.8.6 Compliance simulations for EU Grid Supply Points

ECP.A.8.6.1 Networks Operators who are also EU Code Users, are required to provide simulation studies (or make available equivalent information) at each EU Grid Supply Point to demonstrate compliance with the Reactive Power capability requirements set out in ECC.6.4.5. The study or equivalent information provided shall include a steady state simulation model under both maximum and minimum demand conditions. In addition, the model or equivalent information provided shall include the conditions when the Reactive Power export is at an Active Power flow of less than 25% of the Maximum Import Capability as detailed under ECC.6.4.5.2. In all cases the models or equivalent information submitted shall be agreed and approved with NGET.

ECP.A.8.7 Compliance simulations for Non-Embedded Customers Plant and Apparatus

ECP.A.8.7.1 None Embedded Customers who are also EU Code Users are required at each EU Grid Supply Point to provide simulation studies (or equivalent information) to demonstrate compliance with the Reactive Power capability requirements set out in ECC.6.4.5. The study or equivalent information provided shall include a steady state simulation model under both maximum and minimum demand conditions and with and without on-site generation. In all cases the models or equivalent information submitted shall be agreed and approved with NGET.

ECP.A.8.8 Compliance monitoring at EU Grid Supply Points

ECP.A.8.8.1 To satisfy the requirements of ECC.6.4.5, EU Code Users who are either Network Operators or Non-Embedded Customers shall ensure their Plant and Apparatus is equipped (where applicable) with the necessary equipment to measure the Active Power and Reactive Power, at each EU Grid Supply Point. The requirement for and time frame for compliance monitoring shall be agreed between NGET and the EU Code User for each EU Grid Supply Point.

Formatted: Font: (Default) Arial

Formatted: Font: (Default) Arial

Formatted: Font: (Default) Arial

Formatted: Font: (Default) Arial

Formatted: Font: (Default) Arial

Formatted: Font: (Default) Arial

Formatted: Font: (Default) Arial

Formatted: Font: (Default) Arial

Formatted: Indent: Left: 0 cm, Hanging: 2.5 cm, Tab stops: 2.5 cm, Left + Not at 3 cm

Formatted: Font: (Default) Arial

Formatted: Font: (Default) Arial

Formatted: Font: (Default) Arial

Formatted: Indent: Left: 0 cm, First line: 0 cm

Formatted: Normal, Indent: Left: 0 cm, Hanging: 2.5 cm, No bullets or numbering, Tab stops: 0 cm, Left

Formatted: Font: Not Bold

Formatted: Font: Not Bold

Formatted: Font: Not Bold

Formatted: Font: Bold

Formatted: Font: Bold

Formatted: Font: Bold

Formatted: Font: Bold

Formatted: Font: Bold

Formatted: Font: Bold

Formatted: Font: (Default) Arial

Formatted: Font: Bold

Formatted: Indent: Left: 0 cm, Hanging: 2.54 cm

Formatted: Normal, Indent: Left: 0 cm, Hanging: 2.5 cm, No bullets or numbering, Tab stops: 0 cm, Left

Formatted: Normal, No bullets or numbering

Formatted: Normal, No bullets or numbering, Tab stops: 0 cm, Left

Formatted: Font: Not Bold

Formatted: Normal, No bullets or numbering

Formatted: Font: Not Bold

Formatted: Font: Not Bold

Formatted

Formatted: Font: Bold

Formatted: Font: Bold

Formatted: Font: Bold

Formatted: Font: Bold

Formatted: Font: Bold

Formatted: Font: Bold

Formatted: Font: Bold

Formatted: Font: Not Bold

Formatted: Font: Bold

Formatted: Font: Bold

Formatted: Font: Bold

< End of ECP >

DRAFT

GC0104 DRAFT GLOSSARY AND DEFINITIONS LEGAL TEXT

DATED 25/04/18

1) Blue Highlighted Text – Taken from GC0102 Code Administrator Consultation dated 12/01/2018 - Not relevant for DCC

2) Black – Relevant text for GC0104

3) Track change marked text – relevant changes for GC0104

**GLOSSARY & DEFINITIONS
(GD)**

GD.1 In the Grid Code the following words and expressions shall, unless the subject matter or context otherwise requires or is inconsistent therewith, bear the following meanings:

Access Group	<p>A group of Connection Points within which a User declares under the Planning Code</p> <p>(a) An interconnection and/or</p> <p>(b) A need to redistribute Demand between those Connection Points either pre-fault or post-fault</p> <p>Where a single Connection Point does not form part of an Access Group in accordance with the above, that single Connection Point shall be considered to be an Access Group in its own right.</p>
Access Period	<p>A period of time in respect of which each Transmission Interface Circuit is to be assessed as whether or not it is capable of being maintained as derived in accordance with PC.A.4.1.4. The period shall commence and end on specified calendar weeks.</p>
Act	<p>The Electricity Act 1989 (as amended by the Utilities Act 2000 and the Energy Act 2004).</p>
Active Energy	<p>The electrical energy produced, flowing or supplied by an electric circuit during a time interval, being the integral with respect to time of the instantaneous power, measured in units of watt-hours or standard multiples thereof, ie:</p> <p>1000 Wh = 1 kWh 1000 kWh = 1 MWh 1000 MWh = 1 GWh 1000 GWh = 1 TWh</p>
Active Power	<p>The product of voltage and the in-phase component of alternating current measured in units of watts and standard multiples thereof, ie:</p> <p>1000 Watts = 1 kW 1000 kW = 1 MW 1000 MW = 1 GW 1000 GW = 1 TW</p>

Affiliate	In relation to any person, any holding company or subsidiary of such person or any subsidiary of a holding company of such person, in each case within the meaning of Section 736, 736A and 736B of the Companies Act 1985 as substituted by section 144 of the Companies Act 1989 and, if that latter section is not in force at the Transfer Date , as if such section were in force at such date.
AF Rules	Has the meaning given to “allocation framework” in section 13(2) of the Energy Act 2013.
Agency	As defined in the Transmission Licence .
Alternate Member	Shall mean an alternate member for the Panel Members elected or appointed in accordance with this GR.7.2(a) or (b).
Ancillary Service	A System Ancillary Service and/or a Commercial Ancillary Service , as the case may be. An Ancillary Service may include one or more Demand Response Services.
Ancillary Services Agreement	An agreement between a User and NGET for the payment by NGET to that User in respect of the provision by such User of Ancillary Services .
Annual Average Cold Spell Conditions or ACS Conditions	A particular combination of weather elements which gives rise to a level of peak Demand within a Financial Year which has a 50% chance of being exceeded as a result of weather variation alone.
Apparent Power	The product of voltage and of alternating current measured in units of voltamperes and standard multiples thereof, ie: 1000 VA = 1 kVA 1000 kVA = 1 MVA
Apparatus	Other than in OC8 , means all equipment in which electrical conductors are used, supported or of which they may form a part. In OC8 it means High Voltage electrical circuits forming part of a System on which Safety Precautions may be applied to allow work and/or testing to be carried out on a System .
Approved Fast Track Proposal	Has the meaning given in GR.26.7, provided that no objection is received pursuant to GR.26.12.
Approved Grid Code Self-Governance Proposal	Has the meaning given in GR.24.10.
Approved Modification	Has the meaning given in GR.22.7
Authorised Certifier	An entity that issues Equipment Certificates and Power Generating Module Documents and whose accreditation is given by the national affiliate of the European cooperation for Accreditation ('EA'), established in accordance with Regulation (EC) No 765/2008 of the European Parliament and of the Council (1) ³ .

Formatted: Font: Bold

Formatted: Font: Bold

Formatted: Font: Not Bold

Authorised Electricity Operator	Any person (other than NGET in its capacity as operator of the National Electricity Transmission System) who is authorised under the Act to generate, participate in the transmission of, distribute or supply electricity which shall include any Interconnector Owner or Interconnector User .
Authority-Led Modification	A Grid Code Modification Proposal in respect of a Significant Code Review , raised by the Authority pursuant to GR.17
Authority-Led Modification Report	Has the meaning given in GR.17.4.
Automatic Voltage Regulator or AVR	The continuously acting automatic equipment controlling the terminal voltage of a Synchronous Generating Unit or Synchronous Power Generating Module by comparing the actual terminal voltage with a reference value and controlling by appropriate means the output of an Exciter , depending on the deviations.
Authority for Access	An authority which grants the holder the right to unaccompanied access to sites containing exposed HV conductors.
Authority, The	The Authority established by section 1 (1) of the Utilities Act 2000.
Auxiliaries	Any item of Plant and/or Apparatus not directly a part of the boiler plant or Power Generating Module or Generating Unit or DC Converter or HVDC Equipment or Power Park Module , but required for the boiler plant's or Power Generating Module's or Generating Unit's or DC Converter's or HVDC Equipment's or Power Park Module's functional operation.
Auxiliary Diesel Engine	A diesel engine driving a Power Generating Module or Generating Unit which can supply a Unit Board or Station Board , which can start without an electrical power supply from outside the Power Station within which it is situated.
Auxiliary Gas Turbine	A Gas Turbine Unit , which can supply a Unit Board or Station Board , which can start without an electrical power supply from outside the Power Station within which it is situated.
Average Conditions	That combination of weather elements within a period of time which is the average of the observed values of those weather elements during equivalent periods over many years (sometimes referred to as normal weather).
Back-Up Protection	A Protection system which will operate when a system fault is not cleared by other Protection .
Balancing and Settlement Code or BSC	The code of that title as from time to time amended.

Balancing Code or BC	That portion of the Grid Code which specifies the Balancing Mechanism process.
Balancing Mechanism	Has the meaning set out in NGET's Transmission Licence
Balancing Mechanism Reporting Agent or BMRA	Has the meaning set out in the BSC .
Balancing Mechanism Reporting Service or BMRS	Has the meaning set out in the BSC .
Balancing Principles Statement	A statement prepared by NGET in accordance with Condition C16 of NGET's Transmission Licence .
Baseline Forecast	Has the meaning given to the term 'baseline forecast' in Section G of the BSC .
Bid-Offer Acceptance	(a) A communication issued by NGET in accordance with BC2.7; or (b) an Emergency Instruction to the extent provided for in BC2.9.2.3.
Bid-Offer Data	Has the meaning set out in the BSC .
Bilateral Agreement	Has the meaning set out in the CUSC
Black Start	The procedure necessary for a recovery from a Total Shutdown or Partial Shutdown .
Black Start Capability	An ability in respect of a Black Start Station , for at least one of its Gensets to Start-Up from Shutdown and to energise a part of the System and be Synchronised to the System upon instruction from NGET , within two hours, without an external electrical power supply.
Black Start Contract	An agreement between a Generator and NGET under which the Generator provides Black Start Capability and other associated services.
Black Start Stations	Power Stations which are registered, pursuant to the Bilateral Agreement with a User , as having a Black Start Capability .
Black Start Test	A Black Start Test carried out by a Generator with a Black Start Station , on the instructions of NGET , in order to demonstrate that a Black Start Station has a Black Start Capability .
Block Loading	The maximum step Active Power loading of reconnecting demand during system restoration after a black out.
Block Load Capability	The incremental Active Power steps, from no load to Rated MW , which a generator can instantaneously supply without causing it to trip or go outside the Frequency range of 47.5 – 52Hz (or an otherwise agreed Frequency range). The time between each incremental step shall also be provided.

BM Participant	A person who is responsible for and controls one or more BM Units or where a Bilateral Agreement specifies that a User is required to be treated as a BM Participant for the purposes of the Grid Code. For the avoidance of doubt, it does not imply that they must be active in the Balancing Mechanism .
BM Unit	Has the meaning set out in the BSC , except that for the purposes of the Grid Code the reference to "Party" in the BSC shall be a reference to User .
BM Unit Data	The collection of parameters associated with each BM Unit , as described in Appendix 1 of BC1 .
Boiler Time Constant	Determined at Registered Capacity or Maximum Capacity (as applicable), the boiler time constant will be construed in accordance with the principles of the IEEE Committee Report "Dynamic Models for Steam and Hydro Turbines in Power System Studies" published in 1973 which apply to such phrase.
British Standards or BS	Those standards and specifications approved by the British Standards Institution.
BSCCo	Has the meaning set out in the BSC .
BSC Panel	Has meaning set out for "Panel" in the BSC .
BS Station Test	A Black Start Test carried out by a Generator with a Black Start Station while the Black Start Station is disconnected from all external alternating current electrical supplies.
BS Unit Test	A Black Start Test carried out on a Generating Unit or a CCGT Unit or a Power Generating Module , as the case may be, at a Black Start Station while the Black Start Station remains connected to an external alternating current electrical supply.
Business Day	Any week day (other than a Saturday) on which banks are open for domestic business in the City of London.
Cancellation of National Electricity Transmission System Warning	The notification given to Users when a National Electricity Transmission System Warning is cancelled.
Capacity Market Documents	The Capacity Market Rules , The Electricity Capacity Regulations 2014 and any other Regulations made under Chapter 3 of Part 2 of the Energy Act 2013 which are in force from time to time.
Capacity Market Rules	The rules made under section 34 of the Energy Act 2013 as modified from time to time in accordance with that section and The Electricity Capacity Regulations 2014.

Cascade Hydro Scheme	<p>Two or more hydro-electric Generating Units, owned or controlled by the same Generator, which are located in the same water catchment area and are at different ordnance datums and which depend upon a common source of water for their operation, known as:</p> <ul style="list-style-type: none"> (a) Moriston (b) Killin (c) Garry (d) Conon (e) Clunie (f) Beaully <p>which will comprise more than one Power Station.</p>
Cascade Hydro Scheme Matrix	The matrix described in Appendix 1 to BC1 under the heading Cascade Hydro Scheme Matrix .
Caution Notice	A notice conveying a warning against interference.
Category 1 Intertripping Scheme	A System to Generator Operational Intertripping Scheme arising from a Variation to Connection Design following a request from the relevant User which is consistent with the criteria specified in the Security and Quality of Supply Standard .
Category 2 Intertripping Scheme	<p>A System to Generator Operational Intertripping Scheme which is:-</p> <ul style="list-style-type: none"> (i) required to alleviate an overload on a circuit which connects the Group containing the User's Connection Site to the National Electricity Transmission System; and (ii) installed in accordance with the requirements of the planning criteria of the Security and Quality of Supply Standard in order that measures can be taken to permit maintenance access for each transmission circuit and for such measures to be economically justified, <p>and the operation of which results in a reduction in Active Power on the overloaded circuits which connect the User's Connection Site to the rest of the National Electricity Transmission System which is equal to the reduction in Active Power from the Connection Site (once any system losses or third party system effects are discounted).</p>
Category 3 Intertripping Scheme	A System to Generator Operational Intertripping Scheme which, where agreed by NGET and the User , is installed to alleviate an overload on, and as an alternative to, the reinforcement of a third party system, such as the Distribution System of a Public Distribution System Operator .

Category 4 Intertripping Scheme	A System to Generator Operational Intertripping Scheme installed to enable the disconnection of the Connection Site from the National Electricity Transmission System in a controlled and efficient manner in order to facilitate the timely restoration of the National Electricity Transmission System .
CENELEC	European Committee for Electrotechnical Standardisation.
Citizens Advice	Means the National Association of Citizens Advice Bureaux.
Citizens Advice Scotland	Means the Scottish Association of Citizens Advice Bureaux.
CfD Counterparty	A person designated as a “CfD counterparty” under section 7(1) of the Energy Act 2013.
CfD Documents	The AF Rules , The Contracts for Difference (Allocation) Regulations 2014, The Contracts for Difference (Definition of Eligible Generator) Regulations 2014 and The Contracts for Difference (Electricity Supplier Obligations) Regulations 2014 and any other regulations made under Chapter 2 of Part 2 of the Energy Act 2013 which are in force from time to time.
CfD Settlement Services Provider	means any person: <ul style="list-style-type: none"> (i) appointed for the time being and from time to time by a CfD Counterparty; or (ii) who is designated by virtue of Section C1.2.1B of the Balancing and Settlement Code, <p>in either case to carry out any of the CFD settlement activities (or any successor entity performing CFD settlement activities).</p>
CCGT Module Matrix	The matrix described in Appendix 1 to BC1 under the heading CCGT Module Matrix .
CCGT Module Planning Matrix	A matrix in the form set out in Appendix 3 of OC2 showing the combination of CCGT Units within a CCGT Module which would be running in relation to any given MW output.
Closed Distribution System or CDSO	A distribution system classified pursuant to Article 28 of Directive 2009/72/EC as a Closed Distribution System by the Authority which distributes electricity within a geographically confined industrial, commercial or shared services site and does not supply household Customers , without prejudice to incidental use by a small number of households located within the area served by the System and with employment or similar associations with the owner of the System .

- Formatted: Justified
- Formatted: Font: Bold
- Formatted: Font: Bold
- Formatted: Font: Bold
- Formatted: Font: Bold
- Formatted: Font: Bold

CM Administrative Parties	The Secretary of State , the CM Settlement Body , and any CM Settlement Services Provider .
CM Settlement Body	the Electricity Settlements Company Ltd or such other person as may from time to time be appointed as Settlement Body under regulation 80 of the Electricity Capacity Regulations 2014.
CM Settlement Services Provider	any person with whom the CM Settlement Body has entered into a contract to provide services to it in relation to the performance of its functions under the Capacity Market Documents .
Code Administration Code of Practice	Means the code of practice approved by the Authority and: (a) developed and maintained by the code administrators in existence from time to time; and (b) amended subject to the Authority's approval from time to time; and (c) re-published from time to time;
Code Administrator	Means NGET carrying out the role of Code Administrator in accordance with the General Conditions.
Combined Cycle Gas Turbine Module or CCGT Module	A collection of Generating Units (registered as a CCGT Module (which could be within a Power Generating Module) under the PC) comprising one or more Gas Turbine Units (or other gas based engine units) and one or more Steam Units where, in normal operation, the waste heat from the Gas Turbines is passed to the water/steam system of the associated Steam Unit or Steam Units and where the component units within the CCGT Module are directly connected by steam or hot gas lines which enable those units to contribute to the efficiency of the combined cycle operation of the CCGT Module .
Combined Cycle Gas Turbine Unit or CCGT Unit	A Generating Unit within a CCGT Module .
Commercial Ancillary Services	Ancillary Services , other than System Ancillary Services , utilised by NGET in operating the Total System if a User (or other person <u>such as a Demand Response Provider</u>) has agreed to provide them under an Ancillary Services Agreement or under a Bilateral Agreement with payment being dealt with under an Ancillary Services Agreement or in the case of Externally Interconnected System Operators or Interconnector Users , under any other agreement (and in the case of Externally Interconnected System Operators and Interconnector Users includes ancillary services equivalent to or similar to System Ancillary Services).
Commercial Boundary	Has the meaning set out in the CUSC

Formatted: Font color: Auto, Highlight

Formatted: Font color: Auto, Highlight

Formatted: Font color: Auto, Highlight

Formatted: Font color: Auto, Highlight

Formatted: Font color: Auto, Highlight

Formatted: Font color: Auto, Highlight

Formatted: Font color: Auto, Highlight

Formatted: Font color: Auto

Formatted: Font: Bold

Formatted: Font color: Auto

Formatted: Font color: Auto, Highlight

Committed Project Planning Data	Data relating to a User Development once the offer for a CUSC Contract is accepted.
Common Collection Busbar	A busbar within a Power Park Module to which the higher voltage side of two or more Power Park Unit generator transformers are connected.
Completion Date	Has the meaning set out in the Bilateral Agreement with each User to that term or in the absence of that term to such other term reflecting the date when a User is expected to connect to or start using the National Electricity Transmission System . In the case of an Embedded Medium Power Station or Embedded DC Converter Station or Embedded HVDC System having a similar meaning in relation to the Network Operator's System as set out in the Embedded Development Agreement .
Complex	A Connection Site together with the associated Power Station and/or Network Operator substation and/or associated Plant and/or Apparatus , as appropriate.
Compliance Processes or CP	That portion of the Grid Code which is identified as the Compliance Processes .
Compliance Statement	<p>A statement completed by the relevant User confirming compliance with each of the relevant Grid Code provisions, and the supporting evidence in respect of such compliance, of its:</p> <p>Generating Unit(s); or,</p> <p>Power Generating Modules (including DC Connected Power Park Modules); or,</p> <p>CCGT Module(s); or,</p> <p>Power Park Module(s); or,</p> <p>DC Converter(s); or</p> <p>HVDC Systems; or</p> <p><u>Plant and Apparatus at an EU Grid Supply Point owned or operated by a Network Operator; or</u></p> <p><u>Network Operator's entire distribution System where such Network Operator's distribution System comprises solely of Plant and Apparatus procured on or after 7 September 2018 and was connected to the National Electricity Transmission System on or after 18 August 2019. In this case, all connections to the National Electricity Transmission System would comprise only of EU Grid Supply Points; or</u></p> <p><u>Plant and Apparatus at an EU Grid Supply Point owned or operated by a Non-Embedded Customer where such Non-Embedded Customer is defined as an EU Code User;</u></p> <p>in the form provided by NGET to the relevant User or another format as agreed between the User and NGET.</p>

Formatted: Font color: Auto, Highlight

Formatted: Font color: Auto, Highlight

Formatted: Font color: Auto, Highlight

Formatted: Font color: Auto, Highlight

Formatted: Font color: Auto

Formatted: Font color: Auto

Formatted: Font: Not Bold, Font color: Auto

Formatted: Font color: Auto

Formatted: Font: Not Bold

Formatted: Font: Not Bold

Formatted: Font: Not Bold

Formatted: Font: Not Bold

Formatted: Font: Not Bold

Formatted: Font: Not Bold

Formatted: Font: Not Bold

Formatted: Font: Not Bold

Formatted: Font: Not Bold

Formatted: Font: Not Bold

Formatted: Font: Bold

Formatted: Font: Bold

Formatted: Font: Bold

Formatted: Font: Bold

Formatted: Font: Not Bold, Font color: Auto

Formatted: Font color: Auto

Configuration 1 AC Connected Offshore Power Park Module	One or more Offshore Power Park Modules that are connected to an AC Offshore Transmission System and that AC Offshore Transmission System is connected to only one Onshore substation and which has one or more Interface Points .
Configuration 2 AC Connected Offshore Power Park Module	One or more Offshore Power Park Modules that are connected to a meshed AC Offshore Transmission System and that AC Offshore Transmission System is connected to two or more Onshore substations at its Transmission Interface Points .
Configuration 1 DC Connected Power Park Module	One or more DC Connected Power Park Modules that are connected to an HVDC System or Transmission DC Converter and that HVDC System or Transmission DC Converter is connected to only one Onshore substation and which has one or more Interface Points .
Configuration 2 DC Connected Power Park Module	One or more DC Connected Power Park Modules that are connected to an HVDC System or Transmission DC Converter and that HVDC System or Transmission DC Converter is connected to only more than one Onshore substation at its Transmission Interface Points .
Connection Conditions or CC	That portion of the Grid Code which is identified as the Connection Conditions being applicable to GB Code Existing Users .
Connection Entry Capacity	Has the meaning set out in the CUSC
Connected Planning Data	Data which replaces data containing estimated values assumed for planning purposes by validated actual values and updated estimates for the future and by updated forecasts for Forecast Data items such as Demand .
Connection Point	A Grid Supply Point or Grid Entry Point , as the case may be.
Connection Site	A Transmission Site or User Site , as the case may be.
Construction Agreement	Has the meaning set out in the CUSC
Consumer Representative	Means the person appointed by the Citizens Advice or the Citizens Advice Scotland (or any successor body) representing all categories of customers, appointed in accordance with GR.4.2(b)
Contingency Reserve	The margin of generation over forecast Demand which is required in the period from 24 hours ahead down to real time to cover against uncertainties in Large Power Station availability and against both weather forecast and Demand forecast errors.
Control Calls	A telephone call whose destination and/or origin is a key on the control desk telephone keyboard at a Transmission Control Centre and which, for the purpose of Control Telephony , has the right to exercise priority over (ie. disconnect) a call of a lower status.

Formatted: Font color: Auto, Highlight

Formatted: Font color: Auto, Highlight

Formatted: Font color: Auto, Highlight

Formatted: Font color: Auto, Highlight

Formatted: Font color: Auto, Highlight

Formatted: Highlight

Formatted: Font color: Auto, Highlight

Formatted: Highlight

Formatted: Font color: Auto, Highlight

Formatted: Font color: Auto, Highlight

Formatted: Font color: Auto, Highlight

Formatted: Font color: Auto

Formatted: Font color: Auto

Formatted: Font color: Auto, Highlight

Formatted: Font color: Auto, Highlight

Formatted: Font color: Auto, Highlight

Formatted: Font color: Auto, Highlight

Control Centre	A location used for the purpose of control and operation of the National Electricity Transmission System or DC Converter Station owner's System or HVDC System Owner's System or a User System other than a Generator's System or an External System .
Control Engineer	A person nominated by the relevant party for the control of its Plant and Apparatus .
Control Person	The term used as an alternative to " Safety Co-ordinator " on the Site Responsibility Schedule only.
Control Phase	The Control Phase follows on from the Programming Phase and covers the period down to real time.
Control Point	<p>The point from which:-</p> <p>(a) A Non-Embedded Customer's Plant and Apparatus is controlled; or</p> <p>(b) A BM Unit at a Large Power Station or at a Medium Power Station or representing a Cascade Hydro Scheme or with a Demand Capacity with a magnitude of:</p> <ul style="list-style-type: none"> (i) 50MW or more in NGET's Transmission Area; or (ii) 30MW or more in SPT's Transmission Area; or (iii) 10MW or more in SHETL's Transmission Area, (iv) 10MW or more which is connected to an Offshore Transmission System <p>is physically controlled by a BM Participant; or</p> <p>(c) In the case of any other BM Unit or Generating Unit (which could be part of a Power Generating Module), data submission is co-ordinated for a BM Participant and instructions are received from NGET,</p> <p>as the case may be. For a Generator this will normally be at a Power Station but may be at an alternative location agreed with NGET. In the case of a DC Converter Station or HVDC System, the Control Point will be at a location agreed with NGET. In the case of a BM Unit of an Interconnector User, the Control Point will be the Control Centre of the relevant Externally Interconnected System Operator.</p>
Control Telephony	The principal method by which a User's Responsible Engineer/Operator and NGET Control Engineer(s) speak to one another for the purposes of control of the Total System in both normal and emergency operating conditions.
Core Industry Document	as defined in the Transmission Licence

Formatted: Font color: Auto, Highlight

Formatted: Font color: Auto, Highlight

Formatted: Font color: Auto, Highlight

Formatted: Font color: Auto, Highlight

Formatted: Font color: Auto

Formatted: Font color: Auto, Highlight

Formatted: Font color: Auto, Highlight

Core Industry Document Owner	In relation to a Core Industry Document , the body(ies) or entity(ies) responsible for the management and operation of procedures for making changes to such document
CUSC	Has the meaning set out in NGET's Transmission Licence
CUSC Contract	One or more of the following agreements as envisaged in Standard Condition C1 of NGET's Transmission Licence : (a) the CUSC Framework Agreement ; (b) a Bilateral Agreement ; (c) a Construction Agreement or a variation to an existing Bilateral Agreement and/or Construction Agreement ;
CUSC Framework Agreement	Has the meaning set out in NGET's Transmission Licence
CUSC Party	As defined in the Transmission Licence and "CUSC Parties" shall be construed accordingly.
Customer	A person to whom electrical power is provided (whether or not he is the same person as the person who provides the electrical power).
Customer Demand Management	Reducing the supply of electricity to a Customer or disconnecting a Customer in a manner agreed for commercial purposes between a Supplier and its Customer .
Customer Demand Management Notification Level	The level above which a Supplier has to notify NGET of its proposed or achieved use of Customer Demand Management which is 12 MW in England and Wales and 5 MW in Scotland.
Customer Generating Plant	A Power Station or Generating Unit or Power Generating Module of a Customer to the extent that it operates the same exclusively to supply all or part of its own electricity requirements, and does not export electrical power to any part of the Total System .
Data Registration Code or DRC	That portion of the Grid Code which is identified as the Data Registration Code .
Data Validation, Consistency and Defaulting Rules	The rules relating to validity and consistency of data, and default data to be applied, in relation to data submitted under the Balancing Codes , to be applied by NGET under the Grid Code as set out in the document "Data Validation, Consistency and Defaulting Rules" - Issue 8, dated 25 th January 2012. The document is available on the National Grid website or upon request from NGET .
DC Connected Power Park Module	A Power Park Module that is connected to one or more HVDC Interface Points .

Formatted: Font color: Auto, Highlight

Formatted: Font color: Auto, Highlight

Formatted: Font color: Auto, Highlight

Formatted: Font color: Auto, Highlight

Formatted: Font color: Auto, Highlight

Formatted: Font color: Auto, Highlight

Formatted: Font color: Auto, Highlight

Formatted: Font color: Auto, Highlight

Formatted: Font color: Auto, Highlight

Formatted: Font color: Auto, Highlight

Formatted: Font color: Auto, Highlight

Formatted: Font color: Auto, Highlight

DC Converter	Any Onshore DC Converter or Offshore DC Converter as applicable to GB Code Existing User's.
DC Converter Station	An installation comprising one or more Onshore DC Converters connecting a direct current interconnector: to the NGET Transmission System; or, (if the installation has a rating of 50MW or more) to a User System, and it shall form part of the External Interconnection to which it relates.
DC Network	All items of Plant and Apparatus connected together on the direct current side of a DC Converter or HVDC System.
DCUSA	The Distribution Connection and Use of System Agreement approved by the Authority and required to be maintained in force by each Electricity Distribution Licence holder.
De-Load	The condition in which a Genset has reduced or is not delivering electrical power to the System to which it is Synchronised.
DF	Deviation from Target Frequency
Demand	The demand of MW and Mvar of electricity (i.e. both Active and Reactive Power), unless otherwise stated.
Demand Aggregation	<u>A process where one or more Demand Facilities or Closed Distribution Systems can be controlled by a Demand Response Provider either as a single facility or Closed Distribution System for the purposes of offering one or more Demand Response Services.</u>
Demand Capacity	Has the meaning as set out in the BSC.
Demand Control	Any or all of the following methods of achieving a Demand reduction: (a) Customer voltage reduction initiated by Network Operators (other than following an instruction from NGET); (b) Customer Demand reduction by Disconnection initiated by Network Operators (other than following an instruction from NGET); (c) Demand reduction instructed by NGET; (d) automatic low Frequency Demand Disconnection; (e) emergency manual Demand Disconnection.
Demand Control Notification Level	The level above which a Network Operator has to notify NGET of its proposed or achieved use of Demand Control which is 12 MW in England and Wales and 5 MW in Scotland.

Formatted: Font color: Auto, Highlight

Formatted: Font color: Auto, Highlight

Formatted: Font color: Auto, Highlight

Formatted: Font color: Auto, Highlight

Formatted: Font color: Auto, Highlight

Formatted: Font color: Auto, Highlight

Formatted: Font color: Auto, Highlight

Formatted: Font color: Auto

Formatted: Font: Bold

Formatted: Font color: Auto

Formatted: Font color: Auto

Formatted: Font color: Auto

<u>Demand Facility</u>	<u>A facility which consumes electrical energy and is connected at one or more Grid Supply Points to the National Electricity Transmission System or connection points to a Network Operator's System. A Network Operator's System and/or auxiliary supplies of a Power Generating Module do not constitute a Demand Facility.</u>
<u>Demand Facility Owner</u>	<u>A person who owns or operates one or more Demand Units within a Demand Facility. A Demand Facility Owner who owns or operates a Demand Facility which is directly connected to the Transmission System shall be treated as a Non Embedded Customer.</u>
<u>Demand Response Active Power Control</u>	<u>Demand within a Demand Facility or Closed Distribution System that is available for modulation by NGET or Network Operator or Relevant Transmission Licensee, which results in an Active Power modification.</u>
<u>Demand Response Provider</u>	<u>A party (other than NGET) who owns, operates, controls or manages Main Plant and Apparatus (excluding storage equipment) which was first connected to the Total System on or after 18 August 2019 and who had placed Purchase Contracts for its Main Plant and Apparatus on or after 7 September 2018 or is the subject of a Substantial Modification on or after 18 August 2019 and has an agreement with NGET to provide a Demand Response Service(s). The party may be one or more Customers, a Network Operator or Non-Embedded Customer or EU Code User contracting bilaterally with NGET for the provision of services, or may be a third party providing Demand Aggregation from many individual Customers.</u>
<u>Demand Response Reactive Power Control</u>	<u>A Demand Response Service derived from Reactive Power or Reactive Power compensation devices in a Demand Facility or Closed Distribution System that are available for modulation by NGET or Network Operator or Relevant Transmission Licensee.</u>
<u>Demand Response Transmission Constraint Management</u>	<u>A Demand Response Service derived from Demand within a Demand Facility or Closed Distribution System that is available for modulation by NGET or Network Operator or Relevant Transmission Licensee to manage transmission constraints within the System.</u>
<u>Demand Response Service</u>	<u>A Demand Response Service includes one or more of the following services:</u> <ul style="list-style-type: none"> <u>(a) Demand Response Active Power Control;</u> <u>(b) Demand Response Reactive Power Control;</u> <u>(c) Demand Response Transmission Constraint Management;</u> <u>(d) Demand Response System Frequency Control;</u> <u>(e) Demand Response Very Fast Active Power Control.</u> <u>The above Demand Response Services are not exclusive and do not preclude Demand Response Providers from negotiating other services for demand response capability with NGET. Where such services are negotiated they would still be treated as a Demand Response Service.</u>
<u>Demand Response Services Code (DRSC)</u>	<u>That portion of the Grid Code which is identified as the Demand Response Services Code being applicable to Demand Response Providers.</u>

Formatted: Font: Bold

Formatted: Not Highlight

Formatted: Font: Calibri, 11 pt

Formatted: Font: Calibri, 11 pt, Bold

Formatted: Font: Calibri, 11 pt

Formatted: Font: Bold

Formatted: Font: Bold

Formatted: Font: Calibri, 11 pt

Formatted: Font: Calibri, 11 pt, Bold

Formatted: Font: Calibri, 11 pt

Formatted: Font: Calibri, 11 pt

Formatted: Font: Bold

Formatted: Font: Bold

Formatted: Font: Not Bold

Formatted: Font: Calibri, 11 pt

Formatted: Font: Calibri, 11 pt, Bold

Formatted: Font: Calibri, 11 pt

Formatted: Font: Bold

Formatted: Font: Calibri, 11 pt

Formatted: Font: Calibri, 11 pt, Bold

Formatted: Not Highlight

Formatted: Font: Not Bold

Formatted: Font: Not Bold

Formatted: Font: Not Bold

Formatted: Font: Not Bold

Formatted: Font: Not Bold

Formatted: Not Highlight

Formatted: Font: Not Bold

Formatted: Font: Not Bold

Formatted: Font: Not Bold

Formatted: Font: Not Bold

Formatted: Indent: Left: 0.06 cm, Hanging: 0.75 cm, Numbered + Level: 1 + Numbering Style: a, b, c, ... + Start at: 1 + Alignment: Left + Aligned at: 0.63 cm + Indent at: 1.27 cm

Formatted: Justified, Indent: Left: 0.06 cm

Formatted: Font: Bold

Formatted: Font: Bold

Formatted: Font: Bold

Formatted: Indent: First line: 0.06 cm

Formatted: Font: Bold

Demand Response System Frequency Control	A Demand Response Service derived from a Demand within one or more Demand Facilities or Closed Distribution Systems that is available for the reduction or increase in response to Frequency fluctuations, made by an autonomous response from those Demand Facilities or Closed Distribution Systems to diminish these fluctuations.
Demand Response Unit Document (DRUD)	A document, issued either by the Network Operator, Non Embedded Customer, Demand Facility Owner or the CDSO to NGET or the Network Operator (as the case may be) for Demand Units with demand response and providing a Demand Response Service which confirms the compliance of the Demand Unit with the technical requirements set out in the Grid Code and provides the necessary data and statements, including a statement of compliance.
Demand Response Very Fast Active Power Control	A Demand Response Service derived from a Demand within a Demand Facility or Closed Distribution System that can be modulated very fast in response to a Frequency deviation, which results in a very fast Active Power modification.
Demand Unit	An indivisible set of installations containing equipment which can or could actively control the Demand at one or more sites by a Demand Response Provider, Demand Facility Owner, CDSO or by a Non Embedded Customer, either individually or commonly as part of Demand Aggregation through a third party who has agreed to provide Demand Response Services.
Designed Minimum Operating Level	The output (in whole MW) below which a Genset or a DC Converter at a DC Converter Station (in any of its operating configurations) has no High Frequency Response capability.
De-Synchronise	(a) The act of taking a Power Generating Module (including a DC Connected Power Park Module), Generating Unit, Power Park Module, HVDC System or DC Converter off a System to which it has been Synchronised, by opening any connecting circuit breaker; or (b) The act of ceasing to consume electricity at an importing BM Unit; and the term "De-Synchronising" shall be construed accordingly.
De-synchronised Island(s)	Has the meaning set out in OC9.5.1(a)
Detailed Planning Data	Detailed additional data which NGET requires under the PC in support of Standard Planning Data, comprising DPD I and DPD II
Detailed Planning Data Category I or DPD I	The Detailed Planning Data categorised as such in the DRC and EDRG, and submitted in accordance with PC.4.4.2 or PC.4.4.4 as applicable.
Detailed Planning Data Category II or DPD II	The Detailed Planning Data categorised as such in the DRC and EDRG, and submitted in accordance with PC.4.4.2 or PC.4.4.4 as applicable.
Discrimination	The quality where a relay or protective system is enabled to pick out and cause to be disconnected only the faulty Apparatus.
Disconnection	The physical separation of Users (or Customers) from the National Electricity Transmission System or a User System as the case may be.

Formatted: Font: Not Bold

Formatted: Font: Not Bold

Formatted: Font: Bold

Formatted: Font: Not Bold

Formatted: Font: Not Bold

Formatted: Font: Bold

Formatted: Font: Bold

Formatted: Font: Bold

Formatted: Font color: Auto, Highlight

Formatted: Font color: Auto, Highlight

Formatted: Font color: Auto, Highlight

Formatted: Font color: Auto, Highlight

Formatted: Font color: Auto, Highlight

Formatted: Highlight

Formatted: Font color: Auto, Highlight

Formatted: Font color: Auto, Highlight

Formatted: Highlight

Formatted: Font color: Auto, Highlight

Formatted: Font color: Auto, Highlight

Formatted: Font color: Auto, Highlight

Disputes Resolution Procedure	The procedure described in the CUSC relating to disputes resolution.
Distribution Code	The distribution code required to be drawn up by each Electricity Distribution Licence holder and approved by the Authority , as from time to time revised with the approval of the Authority .
Droop	The ratio of the per unit steady state change in speed, or in Frequency to the per unit steady state change in power output. Whilst not mandatory, it is often common practice to express Droop in percentage terms.
Dynamic Parameters	Those parameters listed in Appendix 1 to BC1 under the heading BM Unit Data – Dynamic Parameters .
E&W Offshore Transmission System	An Offshore Transmission System with an Interface Point in England and Wales.
E&W Offshore Transmission Licensee	A person who owns or operates an E&W Offshore Transmission System pursuant to a Transmission Licence .
E&W Transmission System	Collectively NGET's Transmission System and any E&W Offshore Transmission Systems .
E&W User	A User in England and Wales or any Offshore User who owns or operates Plant and/or Apparatus connected (or which will at the OTSUA Transfer Time be connected) to an E&W Offshore Transmission System .
Earth Fault Factor	At a selected location of a three-phase System (generally the point of installation of equipment) and for a given System configuration, the ratio of the highest root mean square phase-to-earth power Frequency voltage on a sound phase during a fault to earth (affecting one or more phases at any point) to the root mean square phase-to-earth power Frequency voltage which would be obtained at the selected location without the fault.
Earthing	A way of providing a connection between conductors and earth by an Earthing Device which is either: <ul style="list-style-type: none"> (a) Immobilised and Locked in the earthing position. Where the Earthing Device is Locked with a Safety Key, the Safety Key must be secured in a Key Safe and the Key Safe Key must be, where reasonably practicable, given to the authorised site representative of the Requesting Safety Co-ordinator and is to be retained in safe custody. Where not reasonably practicable the Key Safe Key must be retained by the authorised site representative of the Implementing Safety Co-ordinator in safe custody; or (b) maintained and/or secured in position by such other method which must be in accordance with the Local Safety Instructions of NGET or the Safety Rules of the Relevant Transmission Licensee or that User, as the case may be.

Formatted: Font color: Auto, Highlight

Formatted: Font color: Auto, Highlight

Formatted: Font color: Auto, Highlight

Formatted: Font color: Auto, Highlight

Formatted: Font color: Auto, Highlight

Formatted: Font color: Auto, Highlight

Formatted: Font color: Auto, Highlight

Formatted: Font color: Auto, Highlight

Formatted: Font color: Auto, Highlight

Formatted: Font color: Auto, Highlight

Earthing Device	A means of providing a connection between a conductor and earth being of adequate strength and capability.
Elected Panel Members	Shall mean the following Panel Members elected in accordance with GR4.2(a): (a) the representative of the Suppliers ; (b) the representative of the Onshore Transmission Licensees ; (c) the representative of the Offshore Transmission Licensees ; and (d) the representatives of the Generators
Electrical Standard	A standard listed in the Annex to the General Conditions .
Electricity Council	That body set up under the Electricity Act, 1957.
Electricity Distribution Licence	The licence granted pursuant to Section 6(1) (c) of the Act .
Electricity Regulation	As defined in the Transmission Licence .
Electricity Supply Industry Arbitration Association	The unincorporated members' club of that name formed inter alia to promote the efficient and economic operation of the procedure for the resolution of disputes within the electricity supply industry by means of arbitration or otherwise in accordance with its arbitration rules.
Electricity Supply Licence	The licence granted pursuant to Section 6(1) (d) of the Act .
Electromagnetic Compatibility Level	Has the meaning set out in Engineering Recommendation G5/4 .
Embedded	Having a direct connection to a User System or the System of any other User to which Customers and/or Power Stations are connected, such connection being either a direct connection or a connection via a busbar of another User or of a Transmission Licensee (but with no other connection to the National Electricity Transmission System).
Embedded Development	Has the meaning set out in PC.4.4.3(a)
Embedded Development Agreement	An agreement entered into between a Network Operator and an Embedded Person , identifying the relevant site of connection to the Network Operator's System and setting out other site specific details in relation to that use of the Network Operator's System .
Embedded Person	The party responsible for a Medium Power Station not subject to a Bilateral Agreement or DC Converter Station not subject to a Bilateral Agreement or HVDC System not subject to a Bilateral Agreement connected to or proposed to be connected to a Network Operator's System .

Formatted: Font color: Auto, Highlight

Formatted: Font color: Auto, Highlight

Formatted: Font color: Auto, Highlight

Formatted: Font color: Auto, Highlight

Formatted: Font color: Auto, Highlight

Formatted: Font color: Auto, Highlight

Formatted: Font color: Auto, Highlight

Formatted: Font color: Auto, Highlight

Formatted: Font color: Auto, Highlight

Formatted: Font color: Auto, Highlight

Formatted: Font color: Auto, Highlight

Formatted: Font color: Auto, Highlight

Formatted: Font color: Auto, Highlight

Emergency Deenergisation Instruction	an Emergency Instruction issued by NGET to De-Synchronise a Power Generating Module (including a DC Connected Power Park Module), Generating Unit, Power Park Module, HVDC System or DC Converter in circumstances specified in the CUSC .
Emergency Instruction	An instruction issued by NGET in emergency circumstances, pursuant to BC2.9, to the Control Point of a User . In the case of such instructions applicable to a BM Unit , it may require an action or response which is outside the Dynamic Parameters, QPN or Other Relevant Data , and may include an instruction to trip a Genset .
EMR Administrative Parties	Has the meaning given to “administrative parties” in The Electricity Capacity Regulations 2014 and each CfD Counterparty and CfD Settlement Services Provider .
EMR Documents	The Energy Act 2013, The Electricity Capacity Regulations 2014, the Capacity Market Rules , The Contracts for Difference (Allocation) Regulations 2014, The Contracts for Difference (Definition of Eligible Generator) Regulations 2014, The Contracts for Difference (Electricity Supplier Obligations) Regulations 2014, The Electricity Market Reform (General) Regulations 2014, the AF Rules and any other regulations or instruments made under Chapter 2 (contracts for difference), Chapter 3 (capacity market) or Chapter 4 (investment contracts) of Part 2 of the Energy Act 2013 which are in force from time to time.
EMR Functions	Has the meaning given to “EMR functions” in Chapter 5 of Part 2 of the Energy Act 2013.
Engineering Recommendations	The documents referred to as such and issued by the Energy Networks Association or the former Electricity Council.
Energisation Operational Notification or EON	A notification (in respect of Plant and Apparatus (including OTSUA) which is directly connected to the National Electricity Transmission System) from NGET to a User confirming that the User can in accordance with the Bilateral Agreement and/or Construction Agreement , energise such User’s Plant and Apparatus (including OTSUA) specified in such notification.
Equipment Certificate	A document issued by an Authorised Certifier for equipment used by a Power Generating Module, Demand Unit, Network Operators System, Non Embedded Customers System, Demand Facility or HVDC System . The Equipment Certificate defines the scope of its validity at a national or other level at which a specific value is selected from the range allowed at a European level. For the purpose of replacing specific parts of the compliance process, the Equipment Certificate may include models <u>or equivalent information</u> that have been verified against actual test results.

Formatted: Font color: Auto, Highlight

Formatted: Font color: Auto, Highlight

Formatted: Font color: Auto, Highlight

Formatted: Font color: Auto, Highlight

Formatted: Font color: Auto, Highlight

Formatted: Font color: Auto, Highlight

Formatted: Font color: Auto

Formatted: Font color: Auto

Formatted: Font: Bold

Formatted: Font: Bold, Font color: Auto

Formatted: Font: Bold

Formatted: Font: Bold, Font color: Auto

Formatted: Font color: Auto

Formatted: Font color: Auto

Formatted: Font color: Auto

Estimated Registered Data	Those items of Standard Planning Data and Detailed Planning Data which either upon connection will become Registered Data , or which for the purposes of the Plant and/or Apparatus concerned as at the date of submission are Registered Data , but in each case which for the seven succeeding Financial Years will be an estimate of what is expected.
EU Code User	<p>A User who is any of the following:-</p> <p>(a) A Generator in respect of a Power Generating Module (excluding a DC Connected Power Park Module) or OTSDUA (in respect of an AC Offshore Transmission System) whose Main Plant and Apparatus is connected to the System after 17 May 2019 and who concluded Purchase Contracts for its Main Plant and Apparatus after 17 May 2018</p> <p>(b) -A Generator in respect of any Type C or Type D Power Generating Module which is the subject of a Substantial Modification which is effective on or after 17 May 2019.</p> <p>(c) A Generator in respect of any DC Connected Power Park Module whose Main Plant and Apparatus is connected to the System after 28 September 2019 and who had concluded Purchase Contracts for its Main Plant and Apparatus after 28 September 2018.</p> <p>(d) A Generator in respect of any DC Connected Power Park Module which is the subject of a Substantial Modification which is effective on or after 28 September 2019.</p> <p>(e) An HVDC System Owner or OTSDUA (in respect of a DC Offshore Transmission System including a TransmisionTransmission DC Converter) whose Main Plant and Apparatus is connected to the System after 28 September 2019 and who had concluded Purchase Contracts for its Main Plant and Apparatus after 28 September 2018.</p> <p>(f) An HVDC System Owner or OTSDUA (in respect of a DC Offshore Transmission System including a TransmisionTransmission DC Converter) whose HVDC System or DC Offshore Transmission System including a Transmission DC Converter) is the subject of a Substantial Modification on or after 28 September 2019.</p> <p>(g) A User which the Authority has determined should be considered as an EU Code User.</p>

Formatted: Font color: Auto, Highlight

Formatted: Font color: Auto

Formatted: Font color: Auto

Formatted: Font color: Auto

<p>EU Code User</p>	<p>(h) A Network Operator whose total System was first connected to the Transmission System after 7 September 2019 or who had placed Purchase Contracts for its Main Plant and Apparatus after 7 September 2018 or had substantially Substantially Modified their Network Operators System after 7 September 2019.</p> <p>(h) A Network Operator whose connects a new substation-entire distribution System was first connected to the National Electricity Transmission System on or after 187 AugustSeptember 2019 and/or who had placed Purchase Contracts for its Main Plant and Apparatus in respect of its entiretotal distribution System Main Plant and Apparatus on or after 7 September 2018. For the avoidance of doubt, a Network Operator will be an EU Code User if its entire distribution System is connected to the National Electricity Transmission System at EU Grid Supply Points only, in respect of a new Substation or had substantially Substantially Modified their Transmission-connected substation after 7 September 2019.</p> <p>(i) A Non Embedded Customer whose's Main Plant and Apparatus at each EU Grid Supply Point was first connected to the National Electricity Transmission System on or after 187 AugustSeptember 2019 and/or who had placed Purchase Contracts for its Main Plant and Apparatus at each EU Grid Supply Point on or after 7 September 2018 or is the subject of a had substantially Substantially Modified their Plant and Apparatus on or after 187 AugustSeptember 2019.</p>
<p>EU Generator</p>	<p>A Generator or OTSDUA who is also an EU Code User.</p>
<p>EU Grid Supply Point</p>	<p>A Grid Supply Point where either:-</p> <p>(i) (a) the Network Operator or Non Embedded Customer had placed Purchase Contracts for all of its Plant and Apparatus at that Grid Supply Point on or after 7 September 2018, and</p> <p>(b) All of the Network Operator's or Non Embedded Customer's Plant and Apparatus at that Grid Supply Point was first connected to the Transmission System on or after 18 August 2019; or</p> <p>(ii) the Network Operator's or Non Embedded Customer's Plant and Apparatus at a Grid Supply Point is the subject of a Substantial Modification which is effective on or after 18 August 2019.</p>

- Formatted: Font color: Auto
- Formatted: Font: Bold
- Formatted: Font: Bold
- Formatted: Font: Bold
- Formatted: Font: Bold
- Formatted: Font: Bold
- Formatted: Font: Bold
- Formatted: Font: Bold
- Formatted: Font: Bold
- Formatted: Font: Bold
- Formatted: Font: Bold
- Formatted: Font: Not Bold
- Formatted: Indent: Left: 0.06 cm, Hanging: 1.25 cm
- Formatted: Font: Bold
- Formatted: Font: Bold
- Formatted: Font: Not Bold
- Formatted: Font color: Auto, Highlight
- Formatted: Not Highlight
- Formatted: Font: Bold
- Formatted: Numbered + Level: 1 + Numbering Style: i, ii, iii, ... + Start at: 1 + Alignment: Left + Aligned at: 1 cm + Indent at: 1.63 cm
- Formatted: Font: Bold
- Formatted: Font: Bold
- Formatted: Font: Not Bold
- Formatted: Font: Bold
- Formatted: Numbered + Level: 1 + Numbering Style: a, b, c, ... + Start at: 2 + Alignment: Left + Aligned at: 1.63 cm + Indent at: 2.27 cm
- Formatted: Font: Not Bold
- Formatted: Font: Bold
- Formatted: Font: Bold
- Formatted: Numbered + Level: 1 + Numbering Style: i, ii, iii, ... + Start at: 1 + Alignment: Left + Aligned at: 1 cm + Indent at: 1.63 cm
- Formatted: Font: Bold
- Formatted: Font: Bold
- Formatted: Font: Bold
- Formatted: Not Highlight

EU Transparency Availability Data	Such data as Customers and Generators are required to provide under Articles 7.1(a) and 7.1(b) and Articles 15.1(a), 15.1(b), 15.1(c), 15.1(d) of European Commission Regulation (EU) No. 543/2013 respectively (known as the Transparency Regulation), and which also forms part of DRC Schedule 6 (Users' Outage Data).
European Compliance Processes or ECP	That portion of the Grid Code which is identified as the European Compliance Processes .
European Connection Conditions or ECC	That portion of the Grid Code which is identified as the European Connection Conditions being applicable to EU Code Users .
European Regulation (EU) 2016/631	Commission Regulation (EU) 2016/631 of 14 April 2016 establishing a Network Code on Requirements of Generators
European Regulation (EU) 2016/1388	Commission Regulation (EU) 2016/1388 of 17 August 2016 establishing a Network Code on Demand Connection
European Regulation (EU) 2016/1447	Commission Regulation (EU) 2016/1447 of 26 August 2016 establishing a network code on requirements for Grid Connection of High Voltage Direct Current Systems and Direct Current-connected Power Park Modules
European Specification	A common technical specification, a British Standard implementing a European standard or a European technical approval. The terms "common technical specification", "European standard" and "European technical approval" shall have the meanings respectively ascribed to them in the Regulations .
Event	An unscheduled or unplanned (although it may be anticipated) occurrence on, or relating to, a System (including Embedded Power Stations) including, without limiting that general description, faults, incidents and breakdowns and adverse weather conditions being experienced.
Exciter	The source of the electrical power providing the field current of a synchronous machine.
Excitation System	The equipment providing the field current of a machine, including all regulating and control elements, as well as field discharge or suppression equipment and protective devices.
Excitation System No-Load Negative Ceiling Voltage	The minimum value of direct voltage that the Excitation System is able to provide from its terminals when it is not loaded, which may be zero or a negative value.
Excitation System Nominal Response	Shall have the meaning ascribed to that term in IEC 34-16-1:1991 [equivalent to British Standard BS4999 Section 116.1 : 1992]. The time interval applicable is the first half-second of excitation system voltage response.

Formatted: Font color: Auto, Highlight

Formatted: Font color: Auto

Formatted: Font color: Auto

Formatted: Font color: Auto, Highlight

Formatted: Font color: Auto

Formatted: Font color: Auto, Highlight

Formatted: Font color: Auto, Highlight

Formatted: Font color: Auto, Highlight

Formatted: Font color: Auto, Highlight

Formatted: Font color: Auto, Highlight

Formatted: Font color: Auto, Highlight

Formatted: Font color: Auto, Highlight

Excitation System On-Load Positive Ceiling Voltage	Shall have the meaning ascribed to the term 'Excitation system on load ceiling voltage' in IEC 34-16-1:1991[equivalent to British Standard BS4999 Section 116.1 : 1992].
Excitation System No-Load Positive Ceiling Voltage	Shall have the meaning ascribed to the term 'Excitation system no load ceiling voltage' in IEC 34-16-1:1991[equivalent to British Standard BS4999 Section 116.1 : 1992].
Exemptable	Has the meaning set out in the CUSC.
Existing AGR Plant	The following nuclear advanced gas cooled reactor plant (which was commissioned and connected to the Total System at the Transfer Date):- (a) Dungeness B (b) Hinkley Point B (c) Heysham 1 (d) Heysham 2 (e) Hartlepool (f) Hunterston B (g) Torness
Existing AGR Plant Flexibility Limit	In respect of each Genset within each Existing AGR Plant which has a safety case enabling it to so operate, 8 (or such lower number which when added to the number of instances of reduction of output as instructed by NGET in relation to operation in Frequency Sensitive Mode totals 8) instances of flexibility in any calendar year (or such lower or greater number as may be agreed by the Nuclear Installations Inspectorate and notified to NGET) for the purpose of assisting in the period of low System NRAPM and/or low Localised NRAPM provided that in relation to each Generating Unit each change in output shall not be required to be to a level where the output of the reactor is less than 80% of the reactor thermal power limit (as notified to NGET and which corresponds to the limit of reactor thermal power as contained in the "Operating Rules" or "Identified Operating Instructions" forming part of the safety case agreed with the Nuclear Installations Inspectorate).
Existing Gas Cooled Reactor Plant	Both Existing Magnox Reactor Plant and Existing AGR Plant.

Formatted: Font color: Auto, Highlight

Formatted: Font color: Auto, Highlight

Formatted: Font color: Auto, Highlight

Formatted: Font color: Auto, Highlight

Formatted: Font color: Auto, Highlight

Formatted: Font color: Auto, Highlight

Existing Magnox Reactor Plant	The following nuclear gas cooled reactor plant (which was commissioned and connected to the Total System at the Transfer Date): <ul style="list-style-type: none"> (a) Calder Hall (b) Chapelcross (c) Dungeness A (d) Hinkley Point A (e) Oldbury-on-Severn (f) Bradwell (g) Sizewell A (h) Wylfa
Export and Import Limits	Those parameters listed in Appendix 1 to BC1 under the heading BM Unit Data – Export and Import Limits .
External Interconnection	Apparatus for the transmission of electricity to or from the National Electricity Transmission System or a User System into or out of an External System . For the avoidance of doubt, a single External Interconnection may comprise several circuits operating in parallel.
External Interconnection Circuit	Plant or Apparatus which comprises a circuit and which operates in parallel with another circuit and which forms part of the External Interconnection .
Externally Interconnected System Operator or EISO	A person who operates an External System which is connected to the National Electricity Transmission System or a User System by an External Interconnection .
External System	In relation to an Externally Interconnected System Operator means the transmission or distribution system which it owns or operates which is located outside the National Electricity Transmission System Operator Area any Apparatus or Plant which connects that system to the External Interconnection and which is owned or operated by such Externally Interconnected System Operator .
Fast Fault Current	A current delivered by a Power Park Module or HVDC System during and after a voltage deviation caused by an electrical fault within the System with the aim of identifying a fault by network Protection systems at the initial stage of the fault, supporting System voltage retention at a later stage of the fault and System voltage restoration after fault clearance.
Fault Current Interruption Time	The time interval from fault inception until the end of the break time of the circuit breaker (as declared by the manufacturers).

Formatted: Font color: Auto, Highlight

Formatted: Font color: Auto, Highlight

Formatted: Font color: Auto, Highlight

Formatted: Font color: Auto, Highlight

Formatted: Font color: Auto, Highlight

Formatted: Font color: Auto, Highlight

Formatted: Font color: Auto, Highlight

Formatted: Font color: Auto, Highlight

Fault Ride Through	The capability of Power Generating Modules (including DC Connected Power Park Modules) and HVDC Systems to be able to be able to remain connected to the System and operate through periods of low voltage at the Grid Entry Point or User System Entry Point caused by secured faults
Fast Start	A start by a Genset with a Fast Start Capability .
Fast Start Capability	The ability of a Genset to be Synchronised and Loaded up to full Load within 5 minutes.
Fast Track Criteria	A proposed Grid Code Modification Proposal that, if implemented, (a) would meet the Self-Governance Criteria ; and (b) is properly a housekeeping modification required as a result of some error or factual change, including but not limited to: (i) updating names or addresses listed in the Grid Code ; (ii) correcting any minor typographical errors; (iii) correcting formatting and consistency errors, such as paragraph numbering; or (iv) updating out of date references to other documents or paragraphs
Final Generation Outage Programme	An outage programme as agreed by NGET with each Generator and each Interconnector Owner at various stages through the Operational Planning Phase and Programming Phase which does not commit the parties to abide by it, but which at various stages will be used as the basis on which National Electricity Transmission System outages will be planned.
Final Operational Notification or FON	A notification from NGET to a Generator or DC Converter Station owner or HVDC System Owner or Network Operator or Non-Embedded Customer confirming that the User has demonstrated compliance: (a) with the Grid Code , (or where they apply, that relevant derogations have been granted), and (b) where applicable, with Appendices F1 to F5 of the Bilateral Agreement , in each case in respect of the Plant and Apparatus specified in such notification.
Final Physical Notification Data	Has the meaning set out in the BSC .
Final Report	A report prepared by the Test Proposer at the conclusion of a System Test for submission to NGET (if it did not propose the System Test) and other members of the Test Panel .

Formatted: Font color: Auto, Highlight

Formatted: Font color: Auto, Highlight

Formatted: Font color: Auto, Highlight

Formatted: Font color: Auto, Highlight

Formatted: Font color: Auto, Highlight

Formatted: Font color: Auto

Formatted: Font: Bold

Formatted: Font: Bold

Formatted: Font color: Auto

Formatted: Font color: Auto, Highlight

Formatted: Font color: Auto, Highlight

Financial Year	Bears the meaning given in Condition A1 (Definitions and Interpretation) of NGET's Transmission Licence.
Fixed Proposed Implementation Date	The proposed date(s) for the implementation of a Grid Code Modification Proposal or Workgroup Alternative Grid Code Modification such date to be a specific date by reference to an assumed date by which a direction from the Authority approving the Grid Code Modification Proposal or Workgroup Alternative Grid Code Modification is required in order for the Grid Code Modification Proposal or any Workgroup Alternative Grid Code Modification , if it were approved, to be implemented by the proposed date.
Flicker Severity (Long Term)	A value derived from 12 successive measurements of Flicker Severity (Short Term) (over a two hour period) and a calculation of the cube root of the mean sum of the cubes of 12 individual measurements, as further set out in Engineering Recommendation P28 as current at the Transfer Date .
Flicker Severity (Short Term)	A measure of the visual severity of flicker derived from the time series output of a flickermeter over a 10 minute period and as such provides an indication of the risk of Customer complaints.
Forecast Data	Those items of Standard Planning Data and Detailed Planning Data which will always be forecast.
Frequency	The number of alternating current cycles per second (expressed in Hertz) at which a System is running.
Governor Deadband	An interval used intentionally to make the frequency control unresponsive In the case of mechanical governor systems the Governor Deadband is the same as Frequency Response Insensitivity
Governor Insensitivity	The inherent feature of the control system specified as the minimum magnitude of change in the frequency or input signal that results in a change of output power or output signal
Frequency Sensitive AGR Unit	Each Generating Unit in an Existing AGR Plant for which the Generator has notified NGET that it has a safety case agreed with the Nuclear Installations Inspectorate enabling it to operate in Frequency Sensitive Mode , to the extent that such unit is within its Frequency Sensitive AGR Unit Limit . Each such Generating Unit shall be treated as if it were operating in accordance with BC3.5.1 provided that it is complying with its Frequency Sensitive AGR Unit Limit .

Formatted: Font color: Auto, Highlight

Formatted: Font color: Auto, Highlight

Formatted: Font color: Auto, Highlight

Formatted: Font color: Auto, Highlight

Formatted: Font color: Auto, Highlight

Formatted: Font color: Auto, Highlight

Formatted: Font color: Auto, Highlight

Frequency Sensitive AGR Unit Limit	In respect of each Frequency Sensitive AGR Unit , 8 (or such lower number which when added to the number of instances of flexibility for the purposes of assisting in a period of low System or Localised NRAPM totals 8) instances of reduction of output in any calendar year as instructed by NGET in relation to operation in Frequency Sensitive Mode (or such greater number as may be agreed between NGET and the Generator), for the purpose of assisting with Frequency control, provided the level of operation of each Frequency Sensitive AGR Unit in Frequency Sensitive Mode shall not be outside that agreed by the Nuclear Installations Inspectorate in the relevant safety case.
Frequency Sensitive Mode	A Genset , or Type C Power Generating Module or Type D Power Generating Module or DC Connected Power Park Module or HVDC System operating mode which will result in Active Power output changing, in response to a change in System Frequency , in a direction which assists in the recovery to Target Frequency , by operating so as to provide Primary Response and/or Secondary Response and/or High Frequency Response .
Fuel Security Code	The document of that title designated as such by the Secretary of State , as from time to time amended.
Gas Turbine Unit	A Generating Unit driven by a gas turbine (for instance by an aero-engine).
Gas Zone Diagram	A single line diagram showing boundaries of, and interfaces between, gas-insulated HV Apparatus modules which comprise part, or the whole, of a substation at a Connection Site (or in the case of OTSDUW Plant and Apparatus, Transmission Interface Site), together with the associated stop valves and gas monitors required for the safe operation of the National Electricity Transmission System or the User System , as the case may be.
Gate Closure	Has the meaning set out in the BSC .

Formatted: Font color: Auto, Highlight

Formatted: Font color: Auto, Highlight

Formatted: Font color: Auto, Highlight

Formatted: Font color: Auto, Highlight

Formatted: Font color: Auto, Highlight

Formatted: Font color: Auto, Highlight

GB Code User	<p>A User in respect of:-</p> <p>(a) A Generator or OTSDUA who se Main Plant and Apparatus is connected to the System before 17 May 2019, or who had concluded Purchase Contracts for its Main Plant and Apparatus before 17 May 2018, or whose Plant and Apparatus is not the subject of a Substantial Modification which is effective on or after 17 May 2019; or</p> <p>(b) A DC Converter Station owner whose Main Plant and Apparatus is connected to the System before 28 September 2019, or who had concluded Purchase Contracts for its Main Plant and Apparatus before 28 September 2018, or whose Plant and Apparatus is not the subject of a Substantial Modification which is effective on or after 28th September 2019; or</p> <p>(c) A Network Operator or Non Embedded Customer or who se Main Plant and Apparatus was connected to the National Electricity Transmission System at a GB Grid Supply Point before 18th August September 20198 or who had placed Purchase Contracts for its Main Plant and Apparatus before 7 September 2018 or that Non Embedded Customer is not the subject of a Substantial Modification which is effective on or after 18 August 2019; has not Substantially Modified their Plant and Apparatus after 7 September 2018; or</p> <p>(d) A Network Operator whose entire distribution System was connected to the National Electricity Transmission System at one or more GB Grid Supply Points before 18 August 2019 or who had placed Purchase Contracts for its Main Plant and Apparatus in respect of its entire distribution System before 7 September 2018 or its entire distribution System is not the subject of a Substantial Modification which is effective on or after 18 August 2019. For the avoidance of doubt, a Network Operator would still be classed as a GB Code User where its entire distribution System was connected to the National Electricity Transmission System at one or more GB Grid Supply Points, even where that entire distribution System may have one or more EU Grid Supply Points but still comprises of GB Grid Supply Points.</p>
GB Generator	A Generator , or OTSDUA , who is also a GB Code User .
GB Grid Supply Point	A Grid Supply Point which is not an EU Grid Supply Point .
GB Synchronous Area	The AC power System in Great Britain which connects User's , Transmission Licensee's and NGET whose AC Plant and Apparatus is considered to operate in synchronism with each other at each Connection Point or User System Entry Point and at the same System Frequency .

- Formatted: Font color: Auto
- Formatted: Font color: Auto
- Formatted: Font color: Auto
- Formatted: Font color: Auto, Not Highlight
- Formatted: Not Highlight
- Formatted: Not Highlight
- Formatted: Font: Bold
- Formatted: Not Highlight
- Formatted: Font: Bold
- Formatted: Font: Bold
- Formatted: Not Highlight
- Formatted: Not Highlight
- Formatted: Not Highlight
- Formatted: Not Highlight
- Formatted: Font: Bold
- Formatted: Not Highlight
- Formatted: Font color: Auto
- Formatted: Not Strikethrough
- Formatted: Font color: Auto
- Formatted: Font: Bold
- Formatted: Not Highlight
- Formatted: Not Highlight
- Formatted: Font: Bold
- Formatted: Font: Bold
- Formatted: Font: Bold
- Formatted: Not Highlight
- Formatted: Font: Bold
- Formatted: Not Highlight
- Formatted: Font: Bold
- Formatted: Font: Not Bold
- Formatted: Not Strikethrough
- Formatted: Font: Bold
- Formatted: Font: Bold
- Formatted: Font: Bold
- Formatted: Font: Bold
- Formatted: Font: Not Bold
- Formatted: Font color: Auto
- Formatted: Font color: Auto, Highlight
- Formatted: Not Highlight
- Formatted: Font: Bold
- Formatted: Font color: Auto, Highlight

GCDF	Means the Grid Code Development Forum.
General Conditions or GC	That portion of the Grid Code which is identified as the General Conditions .
Generating Plant Demand Margin	The difference between Output Usable and forecast Demand .
Generating Unit	An Onshore Generating Unit and/or an Offshore Generating Unit which could also be part of a Power Generating Module .
Generating Unit Data	The Physical Notification, Export and Import Limits and Other Relevant Data only in respect of each Generating Unit (which could be part of a Power Generating Module): (a) which forms part of the BM Unit which represents that Cascade Hydro Scheme ; (b) at an Embedded Exemptable Large Power Station , where the relevant Bilateral Agreement specifies that compliance with BC1 and/or BC2 is required: (i) to each Generating Unit , or (ii) to each Power Park Module where the Power Station comprises Power Park Modules
Generation Capacity	Has the meaning set out in the BSC .
Generation Planning Parameters	Those parameters listed in Appendix 2 of OC2 .
Generator	A person who generates electricity under licence or exemption under the Act acting in its capacity as a generator in Great Britain or Offshore . The term Generator includes a EU Generator and a GB Generator .
Generator Performance Chart	A diagram which shows the MW and Mvar capability limits within which a Generating Unit will be expected to operate under steady state conditions.
Genset	A Power Generating Module (including a DC Connected Power Park Module), Generating Unit , Power Park Module or CCGT Module at a Large Power Station or any Power Generating Module (including a DC Connected Power Park Module), Generating Unit , Power Park Module or CCGT Module which is directly connected to the National Electricity Transmission System .
Good Industry Practice	The exercise of that degree of skill, diligence, prudence and foresight which would reasonably and ordinarily be expected from a skilled and experienced operator engaged in the same type of undertaking under the same or similar circumstances.

Formatted: Font color: Auto, Highlight

Formatted: Font color: Auto, Highlight

Formatted: Font color: Auto, Highlight

Formatted: Font color: Auto, Highlight

Formatted: Font color: Auto, Highlight

Formatted: Font color: Auto, Highlight

Formatted: Font color: Auto, Highlight

Formatted: Font color: Auto, Highlight

Formatted: Font color: Auto, Highlight

Formatted: Font color: Auto, Highlight

Formatted: Font color: Auto, Highlight

Governor Deadband	An interval used intentionally to make the frequency control unresponsive In the case of mechanical governor systems the Governor Deadband is the same as Frequency Response Insensitivity
Governor Insensitivity	The inherent feature of the control system specified as the minimum magnitude of change in the frequency or input signal that results in a change of output power or output signal
Governance Rules or GR	That portion of the Grid Code which is identified as the Governance Rules .
Great Britain or GB	The landmass of England and Wales and Scotland, including internal waters.
Grid Code Fast Track Proposals	A proposal to modify the Grid Code which is raised pursuant to GR.26 and has not yet been approved or rejected by the Grid Code Review Panel .
Grid Code Modification Fast Track Report	A report prepared pursuant to GR.26
Grid Code Modification Register	Has the meaning given in GR.13.1.
Grid Code Modification Report	Has the meaning given in GR.22.1.
Grid Code Modification Procedures	The procedures for the modification of the Grid Code (including the implementation of Approved Modifications) as set out in the Governance Rules .
Grid Code Modification Proposal	A proposal to modify the Grid Code which is not yet rejected pursuant to GR.15.5 or GR.15.6 and has not yet been implemented.
Grid Code Modification Self- Governance Report	Has the meaning given in GR.24.5
Grid Code Objectives	Means the objectives referred to in Paragraph 1b of Standard Condition C14 of NGET's Transmission Licence .
Grid Code Review Panel or Panel	The panel with the functions set out in GR.1.2.
Grid Code Review Panel Recommendation Vote	The vote of Panel Members undertaken by the Panel Chairman in accordance with Paragraph GR.22.4 as to whether in their view they believe each proposed Grid Code Modification Proposal , or Workgroup Alternative Grid Code Modification would better facilitate achievement of the Grid Code Objective(s) and so should be made.

Formatted: Font color: Auto, Highlight

Formatted: Font color: Auto, Highlight

Formatted: Font color: Auto, Highlight

Formatted: Font color: Auto, Highlight

Formatted: Font color: Auto, Highlight

Formatted: Font color: Auto, Highlight

Formatted: Font color: Auto, Highlight

Formatted: Font color: Auto, Highlight

Formatted: Font color: Auto, Highlight

Formatted: Font color: Auto, Highlight

Formatted: Font color: Auto, Highlight

Formatted: Font color: Auto, Highlight

Grid Code Review Panel Self-Governance Vote	The vote of Panel Members undertaken by the Panel Chairman in accordance with GR.24.9 as to whether they believe each proposed Grid Code Modification Proposal, as compared with the then existing provisions of the Grid Code and any Workgroup Alternative Grid Code Modification set out in the Grid Code Modification Self-Governance Report , would better facilitate achievement of the Grid Code Objective(s) .
Grid Code Self-Governance Proposals	Grid Code Modification Proposals which satisfy the Self Governance Criteria .
Grid Entry Point	An Onshore Grid Entry Point or an Offshore Grid Entry Point .
Grid Supply Point	A point of supply from the National Electricity Transmission System to Network Operators or Non-Embedded Customers which could be a GB Grid Supply Point or an EU Grid Supply Point .
Group	Those National Electricity Transmission System sub-stations bounded solely by the faulted circuit(s) and the overloaded circuit(s) excluding any third party connections between the Group and the rest of the National Electricity Transmission System , the faulted circuit(s) being a Secured Event .
Headroom	The Power Available (in MW) less the actual Active Power exported from the Power Park Module (in MW).
High Frequency Response	An automatic reduction in Active Power output in response to an increase in System Frequency above the Target Frequency (or such other level of Frequency as may have been agreed in an Ancillary Services Agreement). This reduction in Active Power output must be in accordance with the provisions of the relevant Ancillary Services Agreement which will provide that it will be released increasingly with time over the period 0 to 10 seconds from the time of the Frequency increase on the basis set out in the Ancillary Services Agreement and fully achieved within 10 seconds of the time of the start of the Frequency increase and it must be sustained at no lesser reduction thereafter. The interpretation of the High Frequency Response to a + 0.5 Hz frequency change is shown diagrammatically in Figure CC.A.3.3.
High Voltage or HV	For E&W Transmission Systems , a voltage exceeding 650 volts. For Scottish Transmission Systems , a voltage exceeding 1000 volts.
Houseload Operation	Operation which ensures that a Power Station is able to continue to supply its in-house load in the event of System faults resulting in Power-Generating Modules being disconnected from the System and tripped onto their auxiliary supplies
HV Connections	Apparatus connected at the same voltage as that of the National Electricity Transmission System , including Users' circuits, the higher voltage windings of Users' transformers and associated connection Apparatus .

Formatted: Font color: Auto, Highlight

Formatted: Font color: Auto, Highlight

Formatted: Font color: Auto, Highlight

Formatted: Font color: Auto

Formatted: Font color: Auto

Formatted: Font color: Auto, Highlight

Formatted: Font color: Auto, Highlight

Formatted: Font color: Auto, Highlight

Formatted: Font color: Auto, Highlight

Formatted: Font color: Auto, Highlight

Formatted: Font color: Auto, Highlight

HVDC Converter	Any EU Code User Apparatus used to convert alternating current electricity to direct current electricity, or vice versa. An HVDC Converter is a standalone operative configuration at a single site comprising one or more converter bridges, together with one or more converter transformers, reactors, converter control equipment, essential protective and switching devices and auxiliaries, if any, used for conversion. In a bipolar arrangement, an HVDC Converter represents the bipolar configuration.
HVDC Converter Station	Part of an HVDC System which consists of one or more HVDC Converters installed in a single location together with buildings, reactors, filters reactive power devices, control, monitoring, protective, measuring and auxiliary equipment.
HVDC Equipment	Collectively means an HVDC System and a DC Connected Power Park Module and a Remote End HVDC Converter Station .
HVDC Interface Point	A point at which HVDC Plant and Apparatus is connected to an AC System at which technical specifications affecting the performance of the Plant and Apparatus can be prescribed.
HVDC System	An electrical power system which transfers energy in the form of high voltage direct current between two or more alternating current (AC) buses and comprises at least two HVDC Converter Stations with DC Transmission lines or cables between the HVDC Converter Stations .
HVDC System Owner	A party who owns and is responsible for an HVDC System . For the avoidance of doubt a DC Connected Power Park Module owner would be treated as a Generator .
HP Turbine Power Fraction	Ratio of steady state mechanical power delivered by the HP turbine to the total steady state mechanical power delivered by the total steam turbine at Registered Capacity or Maximum Capacity .
IEC	International Electrotechnical Commission.
IEC Standard	A standard approved by the International Electrotechnical Commission.
Implementation Date	Is the date and time for implementation of an Approved Modification as specified in accordance with Paragraph GR.25.3.
Implementing Safety Co-ordinator	The Safety Co-ordinator implementing Safety Precautions .
Import Usable	That portion of Registered Import Capacity which is expected to be available and which is not unavailable due to a Planned Outage .
Incident Centre	A centre established by NGET or a User as the focal point in NGET or in that User , as the case may be, for the communication and dissemination of information between the senior management representatives of NGET , or of that User , as the case may be, and the relevant other parties during a Joint System Incident in order to avoid overloading NGET's , or that User's , as the case may be, existing operational/control arrangements.

Formatted: Font color: Auto, Highlight

Formatted: Font color: Auto, Highlight

Formatted: Font color: Auto, Highlight

Formatted: Font color: Auto, Highlight

Formatted: Font color: Auto, Highlight

Formatted: Font color: Auto, Highlight

Formatted: Font color: Auto, Highlight

Formatted: Font color: Auto, Highlight

Formatted: Font color: Auto, Highlight

Formatted: Font color: Auto, Highlight

Formatted: Font color: Auto, Highlight

Formatted: Font color: Auto, Highlight

Formatted: Font color: Auto, Highlight

Independent Back-Up Protection	A Back-Up Protection system which utilises a discrete relay, different current transformers and an alternate operating principle to the Main Protection systems(s) such that it can operate autonomously in the event of a failure of the Main Protection .
Independent Main Protection	A Main Protection system which utilises a physically discrete relay and different current transformers to any other Main Protection .
Indicated Constraint Boundary Margin	The difference between a constraint boundary transfer limit and the difference between the sum of BM Unit Maximum Export Limits and the forecast of local Demand within the constraint boundary.
Indicated Imbalance	The difference between the sum of Physical Notifications for BM Units comprising Generating Units or CCGT Modules or Power Generating Modules and the forecast of Demand for the whole or any part of the System .
Indicated Margin	The difference between the sum of BM Unit Maximum Export Limits submitted and the forecast of Demand for the whole or any part of the System .
Installation Document	A simple structured document containing information about a Type A Power Generating Module or a Demand Unit , with demand response connected below 1000–V, and confirming its compliance with the relevant requirements;
Instructor Facilities	A device or system which gives certain Transmission Control Centre instructions with an audible or visible alarm, and incorporates the means to return message acknowledgements to the Transmission Control Centre .
Integral Equipment Test or IET	A test on equipment, associated with Plant and/or Apparatus , which takes place when that Plant and/or Apparatus forms part of a Synchronised System and which, in the reasonable judgement of the person wishing to perform the test, may cause an Operational Effect .
Intellectual Property" or "IPRs	Patents, trade marks, service marks, rights in designs, trade names, copyrights and topography rights (whether or not any of the same are registered and including applications for registration of any of the same) and rights under licences and consents in relation to any of the same and all rights or forms of protection of a similar nature or having equivalent or similar effect to any of the same which may subsist anywhere in the world.
Interconnection Agreement	An agreement made between NGET and an Externally Interconnected System Operator and/or an Interconnector User and/or other relevant persons for the External Interconnection relating to an External Interconnection and/or an agreement under which an Interconnector User can use an External Interconnection .

Formatted: Font color: Auto, Highlight

Formatted: Font color: Auto, Highlight

Formatted: Font color: Auto, Highlight

Formatted: Font color: Auto, Highlight

Formatted: Font color: Auto, Highlight

Formatted: Font color: Auto

Formatted: Font color: Auto, Highlight

Formatted: Font color: Auto, Highlight

Formatted: Font color: Auto, Highlight

Formatted: Font color: Auto, Highlight

Interconnector Export Capacity	In relation to an External Interconnection means the (daily or weekly) forecast value (in MW) at the time of the (daily or weekly) peak demand, of the maximum level at which the External Interconnection can export to the Grid Entry Point .
Interconnector Import Capacity	In relation to an External Interconnection means the (daily or weekly) forecast value (in MW) at the time of the (daily or weekly) peak demand of the maximum level at which the External Interconnection can import from the Grid Entry Point .
Interconnector Owner	Has the meaning given to the term in the Connection and Use of System Code .
Interconnector User	Has the meaning set out in the BSC .
Interface Agreement	Has the meaning set out in the CUSC .
Interface Point	As the context admits or requires either; (a) the electrical point of connection between an Offshore Transmission System and an Onshore Transmission System , or (b) the electrical point of connection between an Offshore Transmission System and a Network Operator's User System .
Interface Point Capacity	The maximum amount of Active Power transferable at the Interface Point as declared by a User under the OTSDUW Arrangements expressed in whole MW.
Interface Point Target Voltage/Power factor	The nominal target voltage/power factor at an Interface Point which a Network Operator requires NGET to achieve by operation of the relevant Offshore Transmission System .
Interim Operational Notification or ION	A notification from NGET to a Generator or DC Converter Station owner or HVDC System Operator or Network Operator , or Non Embedded Customer , acknowledging that the User has demonstrated compliance, except for the Unresolved Issues ; (a) with the Grid Code , and (b) where applicable, with Appendices F1 to F5 of the Bilateral Agreement , in each case in respect of the Plant and Apparatus (including OTSUA) specified in such notification and provided that in the case of the OTSDUW Arrangements such notification shall be provided to a Generator in two parts dealing with the OTSUA and Generator's Plant and Apparatus (called respectively " Interim Operational Notification Part A " or " ION A " and " Interim Operational Notification Part B " or " ION B ") as provided for in the CP .

Formatted: Font color: Auto, Highlight

Formatted: Font color: Auto, Highlight

Formatted: Font color: Auto, Highlight

Formatted: Font color: Auto, Highlight

Formatted: Font color: Auto, Highlight

Formatted: Font color: Auto, Highlight

Formatted: Font color: Auto, Highlight

Formatted: Font color: Auto, Highlight

Formatted: Font color: Auto

Formatted: Font: Bold, Font color: Auto

Formatted: Font color: Auto

Formatted: Font: Bold, Font color: Auto

Formatted: Font color: Auto

Intermittent Power Source	The primary source of power for a Generating Unit or Power Generating Module that can not be considered as controllable, e.g. wind, wave or solar.
Intertripping	(a) The tripping of circuit-breaker(s) by commands initiated from Protection at a remote location independent of the state of the local Protection ; or (b) Operational Intertripping .
Intertrip Apparatus	Apparatus which performs Intertripping .
IP Turbine Power Fraction	Ratio of steady state mechanical power delivered by the IP turbine to the total steady state mechanical power delivered by the total steam turbine at Registered Capacity or Maximum Capacity .
Isolating Device	A device for achieving Isolation .
Isolation	The disconnection of HV Apparatus (as defined in OC8A.1.6.2 and OC8B.1.7.2) from the remainder of the System in which that HV Apparatus is situated by either of the following: (a) an Isolating Device maintained in an isolating position. The isolating position must either be: (i) maintained by immobilising and Locking the Isolating Device in the isolating position and affixing a Caution Notice to it. Where the Isolating Device is Locked with a Safety Key , the Safety Key must be secured in a Key Safe and the Key Safe Key must be, where reasonably practicable, given to the authorised site representative of the Requesting Safety Co-Ordinator and is to be retained in safe custody. Where not reasonably practicable the Key Safe Key must be retained by the authorised site representative of the Implementing Safety Co-ordinator in safe custody; or (ii) maintained and/or secured by such other method which must be in accordance with the Local Safety Instructions of NGET or the Safety Rules of the Relevant Transmission Licensee or that User , as the case may be; or (b) an adequate physical separation which must be in accordance with and maintained by the method set out in the Local Safety Instructions of NGET or the Safety Rules of the Relevant Transmission Licensee or that User , as the case may be.
Joint BM Unit Data	Has the meaning set out in the BSC .

Formatted: Font color: Auto, Highlight

Formatted: Font color: Auto, Highlight

Formatted: Font color: Auto, Highlight

Formatted: Font color: Auto, Highlight

Formatted: Font color: Auto, Highlight

Formatted: Font color: Auto, Highlight

Formatted: Font color: Auto, Highlight

Joint System Incident	An Event wherever occurring (other than on an Embedded Medium Power Station or an Embedded Small Power Station) which, in the opinion of NGET or a User , has or may have a serious and/or widespread effect, in the case of an Event on a User(s) System(s) (other than on an Embedded Medium Power Station or Embedded Small Power Station), on the National Electricity Transmission System , and in the case of an Event on the National Electricity Transmission System , on a User(s) System(s) (other than on an Embedded Medium Power Station or Embedded Small Power Station).
Key Safe	A device for the secure retention of keys.
Key Safe Key	A key unique at a Location capable of operating a lock, other than a control lock, on a Key Safe .

Formatted: Font color: Auto, Highlight

Formatted: Font color: Auto, Highlight

Formatted: Font color: Auto, Highlight

<p>Large Power Station</p>	<p>A Power Station which is</p> <p>(a) directly connected to:</p> <ul style="list-style-type: none"> (i) NGET's Transmission System where such Power Station has a Registered Capacity of 100MW or more; or (ii) SPT's Transmission System where such Power Station has a Registered Capacity of 30MW or more; or (iii) SHETL's Transmission System where such Power Station has a Registered Capacity of 10MW or more; or (iv) an Offshore Transmission System where such Power Station has a Registered Capacity of 10MW or more; <p>or,</p> <p>(b) Embedded within a User System (or part thereof) where such User System (or part thereof) is connected under normal operating conditions to:</p> <ul style="list-style-type: none"> (i) NGET's Transmission System and such Power Station has a Registered Capacity of 100MW or more; or (ii) SPT's Transmission System and such Power Station has a Registered Capacity of 30MW or more; or (iii) SHETL's Transmission System and such Power Station has a Registered Capacity of 10MW or more; <p>or,</p> <p>(c) Embedded within a User System (or part thereof) where the User System (or part thereof) is not connected to the National Electricity Transmission System, although such Power Station is in:</p> <ul style="list-style-type: none"> (i) NGET's Transmission Area where such Power Station has a Registered Capacity of 100MW or more; or (ii) SPT's Transmission Area where such Power Station has a Registered Capacity of 30MW or more; or (iii) SHETL's Transmission Area where such Power Station has a Registered Capacity of 10MW or more; <p>For the avoidance of doubt a Large Power Station could comprise of Type A, Type B, Type C or Type D Power Generating Modules.</p>
<p>Legal Challenge</p>	<p>Where permitted by law a judicial review in respect of the Authority's decision to approve or not to approve a Grid Code Modification Proposal.</p>
<p>Licence</p>	<p>Any licence granted to NGET or a Relevant Transmission Licensee or a User, under Section 6 of the Act.</p>

Formatted: Font color: Auto, Highlight

Formatted: Font color: Auto, Highlight

Formatted: Font color: Auto, Highlight

Licence Standards	Those standards set out or referred to in Condition C17 of NGET's Transmission Licence and/or Condition D3 and/or Condition E16 of a Relevant Transmission Licensee's Transmission Licence.
Limited Frequency Sensitive Mode	A mode whereby the operation of the Genset or Power Generating Module (or DC Converter at a DC Converter Station or HVDC Systems exporting Active Power to the Total System) is Frequency insensitive except when the System Frequency exceeds 50.4Hz, from which point Limited High Frequency Response must be provided. For Power Generating Modules (including DC Connected Power Park Modules) and HVDC Systems, operation in Limited Frequency Sensitive Mode would require Limited Frequency Sensitive Mode – Overfrequency (LFSM-O) capability and Limited Frequency Sensitive Mode – Underfrequency (LFSM-U) capability.
Limited Frequency Sensitive Mode – Overfrequency or LFSM-O	A Power Generating Module (including a DC Connected Power Park Module) or HVDC System operating mode which will result in Active Power output reduction in response to a change in System Frequency above a certain value.
Limited Frequency Sensitive Mode – Underfrequency or LFSM-U	A Power Generating Module (including a DC Connected Power Park Module) or HVDC System operating mode which will result in Active Power output increase in response to a change in System Frequency below a certain value.
Limited High Frequency Response	A response of a Genset (or DC Converter at a DC Converter Station exporting Active Power to the Total System) to an increase in System Frequency above 50.4Hz leading to a reduction in Active Power in accordance with the provisions of BC3.7.2.1
Limited Operational Notification or LON	A notification from NGET to a Generator or DC Converter Station owner or HVDC System Owner, or Network Operator or Non-Embedded Customer, stating that the User's Plant and/or Apparatus specified in such notification may be, or is, unable to comply: (a) with the provisions of the Grid Code specified in the notice, and (b) where applicable, with Appendices F1 to F5 of the Bilateral Agreement, and specifying the Unresolved Issues.
Load	The Active, Reactive or Apparent Power, as the context requires, generated, transmitted or distributed.
Loaded	Supplying electrical power to the System.
Load Factor	The ratio of the actual output of a Generating Unit or Power Generating Module to the possible maximum output of that Generating Unit or Power Generating Module.
Load Management Block	A block of Demand controlled by a Supplier or other party through the means of radio teleswitching or by some other means.

Formatted: Font color: Auto, Highlight

Formatted: Font color: Auto, Highlight

Formatted: Font color: Auto, Highlight

Formatted: Font color: Auto, Highlight

Formatted: Font color: Auto, Highlight

Formatted: Font color: Auto, Highlight

Formatted: Font color: Auto, Highlight

Formatted: Font color: Auto

Formatted: Font color: Auto

Formatted: Font: Bold, Font color: Auto

Formatted: Font color: Auto

Formatted: Font: Bold, Font color: Auto

Formatted: Font color: Auto

Formatted: Font color: Auto

Formatted: Font color: Auto

Formatted: Font color: Auto, Highlight

Formatted: Font color: Auto, Highlight

Local Joint Restoration Plan	<p>A plan produced under OC9.4.7.12 detailing the agreed method and procedure by which a Genset at a Black Start Station (possibly with other Gensets at that Black Start Station) will energise part of the Total System and meet complementary blocks of local Demand so as to form a Power Island.</p> <p>In Scotland, the plan may also: cover more than one Black Start Station; include Gensets other than those at a Black Start Station and cover the creation of one or more Power Islands.</p>
Local Safety Instructions	<p>For safety co-ordination in England and Wales, instructions on each User Site and Transmission Site, approved by the relevant NGET or User's manager, setting down the methods of achieving the objectives of NGET's or the User's Safety Rules, as the case may be, to ensure the safety of personnel carrying out work or testing on Plant and/or Apparatus on which his Safety Rules apply and, in the case of a User, any other document(s) on a User Site which contains rules with regard to maintaining or securing the isolating position of an Isolating Device, or maintaining a physical separation or maintaining or securing the position of an Earthing Device.</p>
Local Switching Procedure	<p>A procedure produced under OC7.6 detailing the agreed arrangements in respect of carrying out of Operational Switching at Connection Sites and parts of the National Electricity Transmission System adjacent to those Connection Sites.</p>
Localised Negative Reserve Active Power Margin or Localised NRAPM	<p>That margin of Active Power sufficient to allow transfers to and from a System Constraint Group (as the case may be) to be contained within such reasonable limit as NGET may determine.</p>
Location	<p>Any place at which Safety Precautions are to be applied.</p>
Locked	<p>A condition of HV Apparatus that cannot be altered without the operation of a locking device.</p>
Locking	<p>The application of a locking device which enables HV Apparatus to be Locked.</p>
Low Frequency Relay	<p>Has the same meaning as Under Frequency Relay.</p>
Low Voltage or LV	<p>For E&W Transmission Systems a voltage not exceeding 250 volts. For Scottish Transmission Systems, a voltage exceeding 50 volts but not exceeding 1000 volts.</p>
LV Side of the Offshore Platform	<p>Unless otherwise specified in the Bilateral Agreement, the busbar on the Offshore Platform (typically 33kV) at which the relevant Offshore Grid Entry Point is located.</p>

Formatted: Font color: Auto, Highlight

Formatted: Font color: Auto, Highlight

Formatted: Font color: Auto, Highlight

Formatted: Font color: Auto, Highlight

Formatted: Font color: Auto, Highlight

Formatted: Font color: Auto, Highlight

Formatted: Font color: Auto, Highlight

Formatted: Font color: Auto

Formatted: Font color: Auto

Formatted: Font color: Auto, Highlight

Formatted: Font color: Auto

Main Plant and Apparatus	<p>In respect of a Power Station (including Power Stations comprising of DC Connected Power Park Modules) is one or more of the principleprincipal items of Plant or Apparatus required to convert the primary source of energy into electricity.</p> <p>In respect of HVDC Systems or DC Converters or Transmission DC Converters is one of the principleprincipal items of Plant or Apparatus used to convert high voltage direct current to high voltage alternating current or viceversa.</p> <p><u>In respect of a Network Operator's equipment or a Non-Embedded Customer's equipment, is one of the principal items of Plant or Apparatus required to facilitate the import or export of Active Power or Reactive Power to or from a Network Operator's or Non Embedded Customer's System.</u></p>
Main Protection	A Protection system which has priority above other Protection in initiating either a fault clearance or an action to terminate an abnormal condition in a power system.
Manufacturer's Data & Performance Report	A report submitted by a manufacturer to NGET relating to a specific version of a Power Park Unit demonstrating the performance characteristics of such Power Park Unit in respect of which NGET has evaluated its relevance for the purposes of the Compliance Processes .
Manufacturer's Test Certificates	A certificate prepared by a manufacturer which demonstrates that its Power Generating Module has undergone appropriate tests and conforms to the performance requirements expected by NGET in satisfying its compliance requirements and thereby satisfies the appropriate requirements requirements of the Grid Code and Bilateral Agreement .
Market Operation Data Interface System (MODIS)	A computer system operated by NGET and made available for use by Customers connected to or using the National Electricity Transmission System for the purpose of submitting EU Transparency Availability Data to NGET .
Market Suspension Threshold	Has the meaning given to the term 'Market Suspension Threshold' in Section G of the BSC .
Material Effect	An effect causing NGET or a Relevant Transmission Licensee to effect any works or to alter the manner of operation of Transmission Plant and/or Transmission Apparatus at the Connection Site (which term shall, in this definition and in the definition of " Modification " only, have the meaning ascribed thereto in the CUSC) or the site of connection or a User to effect any works or to alter the manner of operation of its Plant and/or Apparatus at the Connection Site or the site of connection which in either case involves that party in expenditure of more than £10,000.
Materially Affected Party	Any person or class of persons designated by the Authority as such.

Formatted: Font color: Auto

Formatted: Font color: Auto

Formatted: Font color: Auto

Formatted: Font color: Auto

Formatted: Not Highlight

Formatted: Not Highlight

Formatted: Not Highlight

Formatted: Not Highlight

Formatted: Not Highlight

Formatted: Not Highlight

Formatted: Not Highlight

Formatted: Not Highlight

Formatted: Not Highlight

Formatted: Font: Not Bold

Formatted: Font color: Auto

Formatted: Font color: Auto

Formatted: Font color: Auto

Formatted: Font color: Auto

Formatted: Font color: Auto, Highlight

Formatted: Font color: Auto, Highlight

Formatted: Highlight

Formatted: Font color: Auto, Highlight

Formatted: Font color: Auto, Highlight

Formatted: Font color: Auto, Highlight

Formatted: Font color: Auto

Formatted: Font color: Auto

Maximum Export Capability	The maximum continuous Active Power that a Network Operator or Non Embedded Customer can export to the Transmission System at the Grid Supply Point , as specified in the Bilateral Agreement .
Maximum Export Capacity	The maximum continuous Apparent Power expressed in MVA and maximum continuous Active Power expressed in MW which can flow from an Offshore Transmission System connected to a Network Operator's User System , to that User System .
Maximum Capacity or P_{max}	The maximum continuous Active Power which a Power Generating Module can produce, less any demand associated solely with facilitating the operation of that Power Generating Module and not fed into the System .
Maximum Generation Service or MGS	A service utilised by NGET in accordance with the CUSC and the Balancing Principles Statement in operating the Total System .
Maximum Generation Service Agreement	An agreement between a User and NGET for the payment by NGET to that User in respect of the provision by such User of a Maximum Generation Service .
Maximum HVDC Active Power Transmission Capacity (PHmax)	The maximum continuous Active Power which an HVDC System can exchange with the network at each Grid Entry Point or User System Entry Point as specified in the Bilateral Agreement or as agreed between NGET and the HVDC System Owner .
Maximum Import Capability	The maximum continuous Active Power that a Network Operator or Non Embedded Customer can import from the Transmission System at the Grid Supply Point , as specified in the Bilateral Agreement .
Maximum Import Capacity	The maximum continuous Apparent Power expressed in MVA and maximum continuous Active Power expressed in MW which can flow to an Offshore Transmission System connected to a Network Operator's User System , from that User System .

Formatted: Font: Calibri, 11 pt

Formatted: Font: Not Bold

Formatted: Font: Calibri, 11 pt

Formatted: Font color: Auto, Highlight

Formatted: Font color: Auto, Highlight

Formatted: Font color: Auto, Highlight

Formatted: Font color: Auto, Highlight

Formatted: Font: Calibri, 11 pt, Font color: Auto, Highlight

Formatted: Font: Calibri, 11 pt, Font color: Auto, Highlight

Formatted: Font color: Auto, Highlight

Formatted: Font color: Auto, Highlight

Formatted: Font: Calibri, 11 pt

Formatted: Font: Not Bold

Formatted: Font: Calibri, 11 pt

Formatted: Font color: Auto

Medium Power Station	<p>A Power Station which is</p> <p>(a) directly connected to NGET's Transmission System where such Power Station has a Registered Capacity of 50MW or more but less than 100MW;</p> <p>or,</p> <p>(b) Embedded within a User System (or part thereof) where such User System (or part thereof) is connected under normal operating conditions to NGET's Transmission System and such Power Station has a Registered Capacity of 50MW or more but less than 100MW;</p> <p>or,</p> <p>(c) Embedded within a User System (or part thereof) where the User System (or part thereof) is not connected to the National Electricity Transmission System, although such Power Station is in NGET's Transmission Area and such Power Station has a Registered Capacity of 50MW or more but less than 100MW.</p> <p>For the avoidance of doubt a Medium Power Station could comprise of Type A, Type B, Type C or Type D Power Generating Modules.</p>
Medium Voltage or MV	For E&W Transmission Systems a voltage exceeding 250 volts but not exceeding 650 volts.
Mills	Milling plant which supplies pulverised fuel to the boiler of a coal fired Power Station.
Minimum Generation	The minimum output (in whole MW) which a Genset can generate or DC Converter at a DC Converter Station can import or export to the Total System under stable operating conditions, as registered with NGET under the PC (and amended pursuant to the PC). For the avoidance of doubt, the output may go below this level as a result of operation in accordance with BC3.7.
Minimum Active Power Transmission Capacity (PHmin)	The minimum continuous Active Power which an HVDC System can exchange with the System at each Grid Entry Point or User System Entry Point as specified in the Bilateral Agreement or as agreed between NGET and the HVDC System Owner
Minimum Import Capacity	The minimum input (in whole MW) into a DC Converter at a DC Converter Station or HVDC System at an HVDC Converter (in any of its operating configurations) at the Onshore Grid Entry Point (or in the case of an Embedded DC Converter or an Embedded HVDC Converter at the User System Entry Point) at which a DC Converter or HVDC Converter can operate in a stable manner, as registered with NGET under the PC (and amended pursuant to the PC).

Formatted: Font color: Auto, Highlight

Formatted: Font color: Auto

Formatted: Font color: Auto, Highlight

Formatted: Font color: Auto, Highlight

Formatted: Font color: Auto, Highlight

Formatted: Font color: Auto, Highlight

Minimum Regulating Level	The minimum Active Power , as specified in the Bilateral Agreement or as agreed between NGET and the Generator , down to which the Power Generating Module can control Active Power ;
Minimum Stable Operating Level	The minimum Active Power , as specified in the Bilateral Agreement or as agreed between NGET and the Generator , at which the Power Generating Module can be operated stably for an unlimited time.
Modification	Any actual or proposed replacement, renovation, modification, alteration or construction by or on behalf of a User or NGET to either that User's Plant or Apparatus or Transmission Plant or Apparatus , as the case may be, or the manner of its operation which has or may have a Material Effect on NGET or a User , as the case may be, at a particular Connection Site .
Mothballed DC Connected Power Park Module	A DC Connected Power Park Module that has previously generated which the Generator plans not to use to generate for the remainder of the current Financial Year but which could be returned to service.
Mothballed DC Converter at a DC Converter Station	A DC Converter at a DC Converter Station that has previously imported or exported power which the DC Converter Station owner plans not to use to import or export power for the remainder of the current Financial Year but which could be returned to service.
Mothballed HVDC System	An HVDC System that has previously imported or exported power which the HVDC System Owner plans not to use to import or export power for the remainder of the current Financial Year but which could be returned to service.
Mothballed HVDC Converter	An HVDC Converter which is part of an HVDC System that has previously imported or exported power which the HVDC System Owner plans not to use to import or export power for the remainder of the current Financial Year but which could be returned to service.
Mothballed Generating Unit	A Generating Unit that has previously generated which the Generator plans not to use to generate for the remainder of the current Financial Year but which could be returned to service. For the avoidance of doubt a Mothballed Generating Unit could be part of a Power Generating Module .
Mothballed Power Generating Module	A Power Generating Module that has previously generated which the Generator plans not to use to generate for the remainder of the current Financial Year but which could be returned to service.
Mothballed Power Park Module	A Power Park Module that has previously generated which the Generator plans not to use to generate for the remainder of the current Financial Year but which could be returned to service.
Multiple Point of Connection	A double (or more) Point of Connection , being two (or more) Points of Connection interconnected to each other through the User's System .

Formatted: Font color: Auto, Highlight

Formatted: Font color: Auto, Highlight

Formatted: Font color: Auto

Formatted: Font color: Auto, Highlight

Formatted: Font color: Auto, Highlight

Formatted: Font color: Auto, Highlight

Formatted: Font color: Auto, Highlight

Formatted: Font color: Auto, Highlight

Formatted: Font color: Auto, Highlight

Formatted: Font color: Auto, Highlight

Formatted: Font color: Auto, Highlight

Formatted: Font color: Auto, Highlight

National Demand	<p>The amount of electricity supplied from the Grid Supply Points plus:-</p> <ul style="list-style-type: none"> that supplied by Embedded Large Power Stations, and National Electricity Transmission System Losses, <p>minus:-</p> <ul style="list-style-type: none"> the Demand taken by Station Transformers and Pumped Storage Units <p>and, for the purposes of this definition, does not include:-</p> <ul style="list-style-type: none"> any exports from the National Electricity Transmission System across External Interconnections.
National Electricity Transmission System	The Onshore Transmission System and, where owned by Offshore Transmission Licensees , Offshore Transmission Systems .
National Electricity Transmission System Demand	<p>The amount of electricity supplied from the Grid Supply Points plus:-</p> <ul style="list-style-type: none"> that supplied by Embedded Large Power Stations, and exports from the National Electricity Transmission System across External Interconnections, and National Electricity Transmission System Losses, <p>and, for the purposes of this definition, includes:-</p> <ul style="list-style-type: none"> the Demand taken by Station Transformers and Pumped Storage Units.
National Electricity Transmission System Losses	The losses of electricity incurred on the National Electricity Transmission System .
National Electricity Transmission System Operator Area	Has the meaning set out in Schedule 1 of NGET's Transmission Licence .
National Electricity Transmission System Study Network Data File	A computer file produced by NGET which in NGET's view provides an appropriate representation of the National Electricity Transmission System for a specific point in time. The computer file will contain information and data on Demand on the National Electricity Transmission System and on Large Power Stations including Genset power output consistent with Output Usable and NGET's view of prevailing system conditions.

Formatted: Font color: Auto

Formatted: Font color: Auto, Highlight

Formatted: Font color: Auto

Formatted: Font color: Auto, Highlight

Formatted: Font color: Auto, Highlight

Formatted: Font color: Auto, Highlight

National Electricity Transmission System Warning	A warning issued by NGET to Users (or to certain Users only) in accordance with OC7.4.8.2, which provides information relating to System conditions or Events and is intended to : (a) alert Users to possible or actual Plant shortage, System problems and/or Demand reductions; (b) inform of the applicable period; (c) indicate intended consequences for Users; and (d) enable specified Users to be in a state of readiness to receive instructions from NGET.
National Electricity Transmission System Warning - Demand Control Imminent	A warning issued by NGET, in accordance with OC7.4.8.7, which is intended to provide short term notice, where possible, to those Users who are likely to receive Demand reduction instructions from NGET within 30 minutes.
National Electricity Transmission System Warning - High Risk of Demand Reduction	A warning issued by NGET, in accordance with OC7.4.8.6, which is intended to alert recipients that there is a high risk of Demand reduction being implemented and which may normally result from an Electricity Margin Notice.
National Electricity Transmission System Warning - Electricity Margin Notice	A warning issued by NGET, in accordance with OC7.4.8.5, which is intended to invite a response from and to alert recipients to a decreased System Margin.
National Electricity Transmission System Warning - Risk of System Disturbance	A warning issued by NGET, in accordance with OC7.4.8.8, which is intended to alert Users of the risk of widespread and serious System disturbance which may affect Users.
Network Data	The data to be provided by NGET to Users in accordance with the PC, as listed in Part 3 of the Appendix to the PC.
Network Operator	A person with a User System directly connected to the National Electricity Transmission System to which Customers and/or Power Stations (not forming part of the User System) are connected, acting in its capacity as an operator of the User System, but shall not include a person acting in the capacity of an Externally Interconnected System Operator or a Generator in respect of OTSUA.
NGET	National Grid Electricity Transmission plc (NO: 2366977) whose registered office is at 1-3 Strand, London, WC2N 5EH.
NGET Control Engineer	The nominated person employed by NGET to direct the operation of the National Electricity Transmission System or such person as nominated by NGET.
NGET Operational Strategy	NGET's operational procedures which form the guidelines for operation of the National Electricity Transmission System.

Formatted: Font color: Auto, Highlight

Formatted: Font color: Auto, Highlight

Formatted: Font color: Auto, Highlight

Formatted: Font color: Auto, Highlight

Formatted: Font color: Auto, Highlight

Formatted: Font color: Auto

Formatted: Font color: Auto

Formatted: Font color: Auto

Formatted: Font color: Auto

Formatted: Font color: Auto, Highlight

No-Load Field Voltage	Shall have the meaning ascribed to that term in IEC 34-16-1:1991 [equivalent to British Standard BS4999 Section 116.1 : 1992].
No System Connection	As defined in OC8A.1.6.2 and OC8B.1.7.2
Notification of User's Intention to Operate	A notification from a Network Operator or Non-Embedded Customer to NGET informing NGET of the date upon which any Network Operator's or Non-Embedded Customer's Plant and Apparatus at an EU Grid Supply Point will be ready to be connected to the Transmission System.
Notification of User's Intention to Synchronise	A notification from a Generator or DC Converter Station owner or HVDC System Owner to NGET informing NGET of the date upon which any OTSUA, a Generating Unit(s), CCGT Module(s), Power Park Module(s), Power Generating Module(s) (including a DC Connected Power Park Module(s)), HVDC System or DC Converter(s) will be ready to be Synchronised to the Total System.
Non-Dynamic Frequency Response Service	A Demand Response Service in which the Demand is controlled through discrete switching rather than through continuous load changes in response to System Frequency changes.
Non-Embedded Customer	A Customer in Great Britain, except for a Network Operator acting in its capacity as such, receiving electricity direct from the Onshore Transmission System irrespective of from whom it is supplied.
Non-Synchronous Generating Unit	An Onshore Non-Synchronous Generating Unit or Offshore Non-Synchronous Generating Unit which could form part of a Power Generating Module.
Normal CCGT Module	A CCGT Module other than a Range CCGT Module.
Novel Unit	A tidal, wave, wind, geothermal, or any similar, Generating Unit.
OC9 De-synchronised Island Procedure	Has the meaning set out in OC9.5.4.
Offshore	Means wholly or partly in Offshore Waters, and when used in conjunction with another term and not defined means that the associated term is to be read accordingly.
Offshore DC Converter	Any User Apparatus located Offshore used to convert alternating current electricity to direct current electricity, or vice versa. An Offshore DC Converter is a standalone operative configuration at a single site comprising one or more converter bridges, together with one or more converter transformers, converter control equipment, essential protective and switching devices and auxiliaries, if any, used for conversion.

Formatted: Font color: Auto, Highlight

Formatted: Font color: Auto, Highlight

Formatted: Font: Bold

Formatted: Font: Bold

Formatted: Font: Bold

Formatted: Font: Bold

Formatted: Font: Bold

Formatted: Font: Bold

Formatted: Font: Bold

Formatted: Font: Bold

Formatted: Font: Not Bold

Formatted: Font color: Auto, Highlight

Formatted: Not Highlight

Formatted: Not Highlight

Formatted: Font: Bold

Formatted: Not Highlight

Formatted: Font: Not Bold

Formatted: Font: Bold

Formatted: Font color: Auto

Formatted: Font color: Auto, Highlight

Formatted: Font color: Auto, Highlight

Formatted: Font color: Auto, Highlight

Formatted: Font color: Auto, Highlight

Formatted: Font color: Auto, Highlight

Formatted: Font color: Auto, Highlight

Offshore HVDC Converter	Any User Apparatus located Offshore used to convert alternating current electricity to direct current electricity, or vice versa. An Offshore HVDC Converter is a standalone operative configuration at a single site comprising one or more converter bridges, together with one or more converter transformers, converter control equipment, essential protective and switching devices and auxiliaries, if any, used for conversion.
Offshore Development Information Statement	A statement prepared by NGET in accordance with Special Condition C4 of NGET's Transmission Licence .
Offshore Generating Unit	Unless otherwise provided in the Grid Code, any Apparatus located Offshore which produces electricity, including, an Offshore Synchronous Generating Unit and Offshore Non-Synchronous Generating Unit which could also be part of a Power Generating Module .
Offshore Grid Entry Point	In the case of:- <ul style="list-style-type: none"> (a) an Offshore Generating Unit or an Offshore Synchronous Power Generating Module or an Offshore DC Converter or an Offshore HVDC Converter, as the case may be, which is directly connected to an Offshore Transmission System, the point at which it connects to that Offshore Transmission System, or; (b) an Offshore Power Park Module which is directly connected to an Offshore Transmission System, the point where one Power Park String (registered by itself as a Power Park Module) or the collection of points where a number of Offshore Power Park Strings (registered as a single Power Park Module) connects to that Offshore Transmission System, or; (c) an External Interconnection which is directly connected to an Offshore Transmission System, the point at which it connects to that Offshore Transmission System.
Offshore Non-Synchronous Generating Unit	An Offshore Generating Unit that is not an Offshore Synchronous Generating Unit including for the avoidance of doubt a Power Park Unit located Offshore .
Offshore Platform	A single structure comprising of Plant and Apparatus located Offshore which includes one or more Offshore Grid Entry Points .

Formatted: Font color: Auto, Highlight

Formatted: Font color: Auto, Highlight

Formatted: Font color: Auto, Highlight

Formatted: Font color: Auto, Highlight

Formatted: Font color: Auto, Highlight

Formatted: Font color: Auto, Highlight

Offshore Power Park Module	A collection of one or more Offshore Power Park Strings (registered as a Power Park Module under the PC). There is no limit to the number of Power Park Strings within the Power Park Module , so long as they either: (a) connect to the same busbar which cannot be electrically split; or (b) connect to a collection of directly electrically connected busbars of the same nominal voltage and are configured in accordance with the operating arrangements set out in the relevant Bilateral Agreement .
Offshore Power Park String	A collection of Offshore Generating Units or Power Park Units that are powered by an Intermittent Power Source , joined together by cables forming part of a User System with a single point of connection to an Offshore Transmission System . The connection to an Offshore Transmission System may include a DC Converter or HVDC Converter .
Offshore Synchronous Generating Unit	An Offshore Generating Unit which could be part of an Offshore Synchronous Power Generating Module in which, under all steady state conditions, the rotor rotates at a mechanical speed equal to the electrical frequency of the National Electricity Transmission System divided by the number of pole pairs of the Generating Unit .
Offshore Synchronous Power Generating Module	A Synchronous Synchronous Power Generating Module located Offshore .
Offshore Tender Process	The process followed by the Authority to make, in prescribed cases, a determination on a competitive basis of the person to whom an offshore transmission licence is to be granted.
Offshore Transmission Distribution Connection Agreement	An agreement entered into by NGET and a Network Operator in respect of the connection to and use of a Network Operator's User System by an Offshore Transmission System .
Offshore Transmission Licensee	Such person in relation to whose Transmission Licence the standard conditions in Section E (offshore transmission owner standard conditions) of such Transmission Licence have been given effect, or any person in that prospective role who has acceded to the STC .
Offshore Transmission System	A system consisting (wholly or mainly) of high voltage electric lines and used for the transmission of electricity from one Power Station to a sub-station or to another Power Station or between sub-stations, and includes any Plant and Apparatus (including OTSUA) and meters in connection with the transmission of electricity but does not include any Remote Transmission Assets . An Offshore Transmission System extends from the Interface Point , or the Offshore Grid Entry Point(s) and may include Plant and Apparatus located Onshore and Offshore and, where the context permits, references to the Offshore Transmission System includes OTSUA .

Formatted: Font color: Auto, Highlight

Formatted: Font color: Auto, Highlight

Formatted: Font color: Auto, Highlight

Formatted: Font color: Auto, Highlight

Formatted: Font color: Auto, Highlight

Formatted: Font color: Auto, Highlight

Formatted: Font color: Auto, Highlight

Formatted: Font color: Auto, Highlight

Formatted: Font color: Auto, Highlight

Offshore Transmission System Development User Works or OTSDUW	In relation to a particular User where the OTSDUW Arrangements apply, means those activities and/or works for the design, planning, consenting and/or construction and installation of the Offshore Transmission System to be undertaken by the User as identified in Part 2 of Appendix I of the relevant Construction Agreement .
Offshore Transmission System User Assets or OTSUA	OTSDUW Plant and Apparatus constructed and/or installed by a User under the OTSDUW Arrangements which form an Offshore Transmission System that once transferred to a Relevant Transmission Licensee under an Offshore Tender Process will become part of the National Electricity Transmission System .
Offshore Waters	Has the meaning given to “offshore waters” in Section 90(9) of the Energy Act 2004 .
Offshore Works Assumptions	In relation to a particular User means those assumptions set out in Appendix P of the relevant Construction Agreement as amended from time to time.
Onshore	Means within Great Britain , and when used in conjunction with another term and not defined means that the associated term is to be read accordingly.
Onshore DC Converter	Any User Apparatus located Onshore with a Completion Date after 1 st April 2005 used to convert alternating current electricity to direct current electricity, or vice versa. An Onshore DC Converter is a standalone operative configuration at a single site comprising one or more converter bridges, together with one or more converter transformers, converter control equipment, essential protective and switching devices and auxiliaries, if any, used for conversion. In a bipolar arrangement, an Onshore DC Converter represents the bipolar configuration.
Onshore Generating Unit	Unless otherwise provided in the Grid Code, any Apparatus located Onshore which produces electricity, including, an Onshore Synchronous Generating Unit and Onshore Non-Synchronous Generating Unit which could also be part of a Power Generating Module .
Onshore Grid Entry Point	A point at which a Onshore Generating Unit or a CCGT Module or a CCGT Unit or an Onshore Power Generating Module or a Onshore DC Converter or an Onshore HVDC Converter or a Onshore Power Park Module or an External Interconnection , as the case may be, which is directly connected to the Onshore Transmission System connects to the Onshore Transmission System .

Formatted: Font color: Auto, Highlight

Formatted: Font color: Auto, Highlight

Formatted: Font color: Auto, Highlight

Formatted: Font color: Auto, Highlight

Formatted: Font color: Auto, Highlight

Formatted: Font color: Auto, Highlight

Formatted: Font color: Auto, Highlight

Formatted: Font color: Auto, Highlight

Onshore HVDC Converter	Any User Apparatus located Onshore used to convert alternating current electricity to direct current electricity, or vice versa. An Onshore HVDC Converter is a standalone operative configuration at a single site comprising one or more converter bridges, together with one or more converter transformers, converter control equipment, essential protective and switching devices and auxiliaries, if any, used for conversion. In a bipolar arrangement, an Onshore HVDC Converter represents the bipolar configuration.
Onshore Non-Synchronous Generating Unit	A Generating Unit located Onshore that is not a Synchronous Generating Unit including for the avoidance of doubt a Power Park Unit located Onshore .
Onshore Power Park Module	A collection of Non-SynchronousSynchronous Generating Units (registered as a Power Park Module under the PC) that are powered by an Intermittent Power Source or connected through power electronic conversion technology, joined together by a System with a single electrical point of connection directly to the Onshore Transmission System (or User System if Embedded) with no intermediate Offshore Transmission System connections. The connection to the Onshore Transmission System (or User System if Embedded) may include a DC Converter or HVDC Converter .
Onshore Synchronous Generating Unit	An Onshore Generating Unit (which could also be part of an Onshore Power Generating Module) including, for the avoidance of doubt, a CCGT Unit in which, under all steady state conditions, the rotor rotates at a mechanical speed equal to the electrical frequency of the National Electricity Transmission System divided by the number of pole pairs of the Generating Unit .
Onshore Synchronous Power Generating Module	A SynchronousSynchronous Power Generating Module located Onshore .
Onshore Transmission Licensee	NGET, SPT, or SHETL.
Onshore Transmission System	The system consisting (wholly or mainly) of high voltage electric lines owned or operated by Onshore Transmission Licensees and used for the transmission of electricity from one Power Station to a substation or to another Power Station or between substations or to or from Offshore Transmission Systems or to or from any External Interconnection , and includes any Plant and Apparatus and meters owned or operated by any Onshore Transmission Licensee in connection with the transmission of electricity but does not include any Remote Transmission Assets .
On-Site Generator Site	A site which is determined by the BSC Panel to be a Trading Unit under the BSC by reason of having fulfilled the Class 1 or Class 2 requirements as such terms are used in the BSC .

Formatted: Font color: Auto, Highlight

Formatted: Font color: Auto, Highlight

Formatted: Font color: Auto, Highlight

Formatted: Font color: Auto, Highlight

Formatted: Font color: Auto, Highlight

Formatted: Font color: Auto, Highlight

Formatted: Font color: Auto, Highlight

Formatted: Font color: Auto, Highlight

Formatted: Font color: Auto, Highlight

Formatted: Font color: Auto, Highlight

Operating Code or OC	That portion of the Grid Code which is identified as the Operating Code .
Operating Margin	Contingency Reserve plus Operating Reserve.
Operating Reserve	The additional output from Large Power Stations or the reduction in Demand , which must be realisable in real-time operation to respond in order to contribute to containing and correcting any System Frequency fall to an acceptable level in the event of a loss of generation or a loss of import from an External Interconnection or mismatch between generation and Demand .
Operation	A scheduled or planned action relating to the operation of a System (including an Embedded Power Station).
Operational Data	Data required under the Operating Codes and/or Balancing Codes .
Operational Day	The period from 0500 hours on one day to 0500 on the following day.
Operation Diagrams	Diagrams which are a schematic representation of the HV Apparatus and the connections to all external circuits at a Connection Site (and in the case of OTSDUW, Transmission Interface Site), incorporating its numbering, nomenclature and labelling.
Operational Effect	Any effect on the operation of the relevant other System which causes the National Electricity Transmission System or the System of the other User or Users , as the case may be, to operate (or be at a materially increased risk of operating) differently to the way in which they would or may have operated in the absence of that effect.
Operational Intertripping	The automatic tripping of circuit-breakers to prevent abnormal system conditions occurring, such as over voltage, overload, System instability, etc. after the tripping of other circuit-breakers following power System fault(s) which includes System to Generating Unit, System to CCGT Module, System to Power Park Module, System to DC Converter, System to Power Generating Module, System to HVDC Converter and System to Demand intertripping schemes.
Operational Notifications	Any Energisation Operational Notification, Preliminary Operational Notification, Interim Operational Notification, Final Operational Notification or Limited Operational Notification issued from NGET to a User.

Formatted: Font color: Auto, Highlight

Formatted: Font color: Auto, Highlight

Formatted: Font color: Auto, Highlight

Formatted: Font color: Auto, Highlight

Formatted: Font color: Auto, Highlight

Formatted: Font color: Auto, Highlight

Formatted: Font color: Auto, Highlight

Formatted: Font color: Auto, Highlight

Formatted: Font color: Auto, Highlight

Formatted: Font color: Auto

Operational Planning	Planning through various timescales the matching of generation output with forecast National Electricity Transmission System Demand together with a reserve of generation to provide a margin, taking into account outages of certain Generating Units or Power Generating Modules , of parts of the National Electricity Transmission System and of parts of User Systems to which Power Stations and/or Customers are connected, carried out to achieve, so far as possible, the standards of security set out in NGET's Transmission Licence , each Relevant Transmission Licensee's Transmission Licence or Electricity Distribution Licence , as the case may be.
Operational Planning Margin	An operational planning margin set by NGET .
Operational Planning Phase	The period from 8 weeks to the end of the 5 th year ahead of real time operation.
Operational Procedures	Management instructions and procedures, both in support of the Safety Rules and for the local and remote operation of Plant and Apparatus , issued in connection with the actual operation of Plant and/or Apparatus at or from a Connection Site .
Operational Switching	Operation of Plant and/or Apparatus to the instruction of the relevant Control Engineer . For the avoidance of doubt, the operation of Transmission Plant and/or Apparatus forming part of the National Electricity Transmission System in England and Wales, will be to the instruction of NGET and in Scotland and Offshore will be to the instruction of the Relevant Transmission Licensee .
Other Relevant Data	The data listed in BC1.4.2(f) under the heading Other Relevant Data .
OTSDUW Arrangements	The arrangements whereby certain aspects of the design, consenting, construction, installation and/or commissioning of transmission assets are capable of being undertaken by a User prior to the transfer of those assets to a Relevant Transmission Licensee under an Offshore Tender Process .
OTSDUW Data and Information	The data and information to be provided by Users undertaking OTSDUW , to NGET in accordance with Appendix F of the Planning Code .
OTSDUW DC Converter	A Transmission DC Converter designed and/or constructed and/or installed by a User under the OTSDUW Arrangements and/or operated by the User until the OTSUA Transfer Time .
OTSDUW Development and Data Timetable	The timetable for both the delivery of OTSDUW Data and Information and OTSDUW Network Data and Information as referred to in Appendix F of the Planning Code and the development of the scope of the OTSDUW .
OTSDUW Network Data and Information	The data and information to be provided by NGET to Users undertaking OTSDUW in accordance with Appendix F of the Planning Code .

Formatted: Font color: Auto, Highlight

Formatted: Font color: Auto, Highlight

Formatted: Font color: Auto, Highlight

Formatted: Font color: Auto, Highlight

Formatted: Font color: Auto, Highlight

Formatted: Font color: Auto, Highlight

Formatted: Font color: Auto, Highlight

Formatted: Font color: Auto, Highlight

Formatted: Font color: Auto, Highlight

Formatted: Font color: Auto, Highlight

Formatted: Font color: Auto, Highlight

OTSDUW Plant and Apparatus	Plant and Apparatus, including any OTSDUW DC Converter, designed by the User under the OTSDUW Arrangements.
OTSUA Transfer Time	The time and date at which the OTSUA are transferred to a Relevant Transmission Licensee.
Out of Synchronism	The condition where a System or Generating Unit or Power Generating Module cannot meet the requirements to enable it to be Synchronised.
Output Usable or OU	The (daily or weekly) forecast value (in MW), at the time of the (daily or weekly) peak demand, of the maximum level at which the Genset can export to the Grid Entry Point, or in the case of Embedded Power Stations, to the User System Entry Point. In addition, for a Genset powered by an Intermittent Power Source the forecast value is based upon the Intermittent Power Source being at a level which would enable the Genset to generate at Registered Capacity. For the purpose of OC2 only, the term Output Usable shall include the terms Interconnector Export Capacity and Interconnector Import Capacity where the term Output Usable is being applied to an External Interconnection.
Over-excitation Limiter	Shall have the meaning ascribed to that term in IEC 34-16-1:1991 [equivalent to British Standard BS4999 Section 116.1 : 1992].
Panel Chairman	A person appointed as such in accordance with GR.4.1.
Panel Member	Any of the persons identified as such in GR.4.
Panel Members' Recommendation	The recommendation in accordance with the "Grid Code Review Panel Recommendation Vote"
Panel Secretary	A person appointed as such in accordance with GR.3.1.2(d).
Part 1 System Ancillary Services	Ancillary Services which are required for System reasons and which must be provided by Users in accordance with the Connection Conditions. An exhaustive list of Part 1 System Ancillary Services is included in that part of CC.8.1 headed Part 1.
Part 2 System Ancillary Services	Ancillary Services which are required for System reasons and which must be provided by a User if the User has agreed to provide them under a Bilateral Agreement. A non-exhaustive list of Part 2 System Ancillary Services is included in that part of CC.8.1 headed Part 2.
Part Load	The condition of a Genset, or Cascade Hydro Scheme which is Loaded but is not running at its Maximum Export Limit.

Formatted: Font color: Auto, Highlight

Formatted: Font color: Auto, Highlight

Formatted: Font color: Auto, Highlight

Formatted: Font color: Auto, Highlight

Formatted: Font color: Auto, Highlight

Formatted: Font color: Auto, Highlight

Formatted: Font color: Auto, Highlight

Formatted: Font color: Auto, Highlight

Formatted: Font color: Auto, Highlight

Formatted: Font color: Auto

Formatted: Font color: Auto

Formatted: Font color: Auto, Highlight

Permit for Work for proximity work	<p>In respect of E&W Transmission Systems, a document issued by the Relevant E&W Transmission Licensee or an E&W User in accordance with its respective Safety Rules to enable work to be carried out in accordance with OC8A.8 and which provides for Safety Precautions to be applied and maintained. An example format of a Relevant E&W Transmission Licensee's permit for work is attached as Appendix E to OC8A.</p> <p>In respect of Scottish Transmission Systems, a document issued by a Relevant Scottish Transmission Licensee or a Scottish User in accordance with its respective Safety Rules to enable work to be carried out in accordance with OC8B.8 and which provides for Safety Precautions to be applied and maintained. Example formats of Relevant Scottish Transmission Licensees' permits for work are attached as Appendix E to OC8B.</p>
Partial Shutdown	The same as a Total Shutdown except that all generation has ceased in a separate part of the Total System and there is no electricity supply from External Interconnections or other parts of the Total System to that part of the Total System and, therefore, that part of the Total System is shutdown, with the result that it is not possible for that part of the Total System to begin to function again without NGET's directions relating to a Black Start .
Pending Grid Code Modification Proposal	A Grid Code Modification Proposal in respect of which, at the relevant time, the Authority has not yet made a decision as to whether to direct such Grid Code Modification Proposal to be made pursuant to the Transmission Licence (whether or not a Grid Code Modification Report has been submitted in respect of such Grid Code Modification Proposal) or, in the case of a Grid Code Self Governance Proposals , in respect of which the Grid Code Review Panel has not yet voted whether or not to approve.
Phase (Voltage) Unbalance	The ratio (in percent) between the rms values of the negative sequence component and the positive sequence component of the voltage.
Physical Notification	Data that describes the BM Participant's best estimate of the expected input or output of Active Power of a BM Unit and/or (where relevant) Generating Unit , the accuracy of the Physical Notification being commensurate with Good Industry Practice .
Planning Code or PC	That portion of the Grid Code which is identified as the Planning Code .

Formatted: Font color: Auto, Highlight

Formatted: Font color: Auto, Highlight

Formatted: Font color: Auto, Highlight

Formatted: Font color: Auto

Formatted: Font color: Auto, Highlight

Formatted: Font color: Auto

Planned Maintenance Outage	An outage of NGET electronic data communication facilities as provided for in CC.6.5.8 and NGET's associated computer facilities of which normally at least 5 days notice is given, but in any event of which at least twelve hours notice has been given by NGET to the User and which is anticipated to last no longer than 2 hours. The length of such an outage may in exceptional circumstances be extended where at least 24 hours notice has been given by NGET to the User. It is anticipated that normally any planned outage would only last around one hour.
Planned Outage	An outage of a Large Power Station or of part of the National Electricity Transmission System, or of part of a User System, co-ordinated by NGET under OC2.
Plant	Fixed and movable items used in the generation and/or supply and/or transmission of electricity, other than Apparatus.
Point of Common Coupling	That point on the National Electricity Transmission System electrically nearest to the User installation at which either Demands or Loads are, or may be, connected.
Point of Connection	An electrical point of connection between the National Electricity Transmission System and a User's System.
Point of Isolation	The point on Apparatus (as defined in OC8A.1.6.2 and OC8B.1.7.2) at which Isolation is achieved.
Post-Control Phase	The period following real time operation.
Power Available	A signal prepared in accordance with good industry practice, representing the instantaneous sum of the potential Active Power available from each individual Power Park Unit within the Power Park Module calculated using any applicable combination of meteorological (including wind speed), electrical or mechanical data measured at each Power Park Unit at a specified time. Power Available shall be a value between OMW and Registered Capacity or Maximum Capacity which is the sum of the potential Active Power available of each Power Park Unit within the Power Park Module. A turbine that is not generating will be considered as not available. For the avoidance of doubt, the Power Available signal would be the Active Power output that a Power Park Module could reasonably be expected to export at the Grid Entry Point or User System Entry Point taking all the above criteria into account including Power Park Unit constraints such as optimisation modes but would exclude a reduction in the Active Power export of the Power Park Module instructed by NGET (for example) for the purposes selecting a Power Park Module to operate in Frequency Sensitive Mode or when an Emergency Instruction has been issued.
Power Factor	The ratio of Active Power to Apparent Power.
Power-Generating Module	Either a Synchronous Power-Generating Module or a Power Park Module owned or operated by an EU Generator.

Formatted: Font color: Auto, Highlight

Formatted: Font color: Auto, Highlight

Formatted: Font color: Auto

Formatted: Font color: Auto

Formatted: Font color: Auto

Formatted: Font color: Auto, Highlight

Formatted: Font color: Auto, Highlight

Formatted: Font color: Auto, Highlight

Formatted: Font color: Auto

Formatted: Font color: Auto, Highlight

Power-Generating Module Document (PGMD)	A document provided by the Generator to NGET for a Type B or Type C Power Generating Module which confirms that the Power Generating Module's compliance with the technical criteria set out in the Grid Code has been demonstrated and provides the necessary data and statements, including a statement of compliance.
Power Generating Module Performance Chart	A diagram showing the Real Power (MW) and Reactive Power (MVar) capability limits within which a Synchronous Power Generating Module or Power Park Module at its Grid Entry Point or User System Entry Point will be expected to operate under steady state conditions.
Power Island	Gensets at an isolated Power Station , together with complementary local Demand . In Scotland a Power Island may include more than one Power Station .
Power Park Module	Any Onshore Power Park Module or Offshore Power Park Module .
Power Park Module Availability Matrix	The matrix described in Appendix 1 to BC1 under the heading Power Park Module Availability Matrix .
Power Park Module Planning Matrix	A matrix in the form set out in Appendix 4 of OC2 showing the combination of Power Park Units within a Power Park Module which would be expected to be running under normal conditions.
Power Park Unit	A Generating Unit within a Power Park Module .
Power Station	An installation comprising one or more Generating Units or Power Park Modules or Power Generating Modules (even where sited separately) owned and/or controlled by the same Generator , which may reasonably be considered as being managed as one Power Station .
Power System Stabiliser or PSS	Equipment controlling the Exciter output via the voltage regulator in such a way that power oscillations of the synchronous machines are dampened. Input variables may be speed, frequency or power (or a combination of these).
Preface	The preface to the Grid Code (which does not form part of the Grid Code and therefore is not binding).
Preliminary Notice	A notice in writing, sent by NGET both to all Users identified by it under OC12.4.2.1 and to the Test Proposer , notifying them of a proposed System Test .
Preliminary Project Planning Data	Data relating to a proposed User Development at the time the User applies for a CUSC Contract but before an offer is made and accepted.

Formatted: Font color: Auto, Highlight

Formatted: Font color: Auto, Highlight

Formatted: Font color: Auto, Highlight

Formatted: Font color: Auto, Highlight

Formatted: Font color: Auto, Highlight

Formatted: Font color: Auto, Highlight

Formatted: Font color: Auto, Highlight

Formatted: Font color: Auto, Highlight

Formatted: Font color: Auto, Highlight

Formatted: Font color: Auto, Highlight

Formatted: Font color: Auto, Highlight

Formatted: Font color: Auto, Highlight

Preliminary Operational Notification or PON	A notification from NGET to a Generator in respect of a Power Station comprising Type B or Type C Power Generating Modules acknowledging that the User has demonstrated compliance, except for the Unresolved Issues; (a) with the Grid Code, and (b) where applicable, with Appendices F1 to F5 of the Bilateral Agreement,
Primary Response	The automatic increase in Active Power output of a Genset or, as the case may be, the decrease in Active Power Demand in response to a System Frequency fall. This increase in Active Power output or, as the case may be, the decrease in Active Power Demand must be in accordance with the provisions of the relevant Ancillary Services Agreement which will provide that it will be released increasingly with time over the period 0 to 10 seconds from the time of the start of the Frequency fall on the basis set out in the Ancillary Services Agreement and fully available by the latter, and sustainable for at least a further 20 seconds. The interpretation of the Primary Response to a - 0.5 Hz frequency change is shown diagrammatically in Figure CC.A.3.2 and Figure ECC.A.3.2
Private Network	A network>User which connects to a Network Operator's System and that network belongs to a User who is not classified as a Generator, Network Operator or Non Embedded Customer.
Programming Phase	The period between the Operational Planning Phase and the Control Phase. It starts at the 8 weeks ahead stage and finishes at 17:00 on the day ahead of real time.
Proposal Notice	A notice submitted to NGET by a User which would like to undertake a System Test.
Proposal Report	A report submitted by the Test Panel which contains: (a) proposals for carrying out a System Test (including the manner in which the System Test is to be monitored); (b) an allocation of costs (including un-anticipated costs) between the affected parties (the general principle being that the Test Proposer will bear the costs); and (c) such other matters as the Test Panel considers appropriate. The report may include requirements for indemnities to be given in respect of claims and losses arising from a System Test.
Proposed Implementation Date	The proposed date(s) for the implementation of a Grid Code Modification Proposal or Workgroup Alternative Grid Code Modification such date(s) to be either (i) described by reference to a specified period after a direction from the Authority approving the Grid Code Modification Proposal or Workgroup Alternative Grid Code Modification or (ii) a Fixed Proposed Implementation Date.

Formatted: Font color: Auto

Formatted: Font color: Auto, Highlight

Formatted: Font color: Auto

Formatted: Font: Not Bold

Formatted: Font color: Auto

Formatted: Font color: Auto

Formatted: Font color: Auto

Formatted: Font color: Auto

Formatted: Font color: Auto, Highlight

Formatted: Highlight

Formatted: Font color: Auto, Highlight

Formatted: Font color: Auto, Highlight

Formatted: Font color: Auto, Highlight

Formatted: Font color: Auto, Highlight

Protection	The provisions for detecting abnormal conditions on a System and initiating fault clearance or actuating signals or indications.
Protection Apparatus	A group of one or more Protection relays and/or logic elements designated to perform a specified Protection function.
Pump Storage	A hydro unit in which water can be raised by means of pumps and stored to be used for the generation of electrical energy.
Pumped Storage Generator	A Generator which owns and/or operates any Pumped Storage Plant .
Pumped Storage Plant	The Dinorwig, Ffestiniog, Cruachan and Foyers Power Stations .
Pumped Storage Unit	A Generating Unit within a Pumped Storage Plant .
Purchase Contracts	A final and binding contract for the purchase of the Main Plant and Apparatus .
Q/Pmax	<p>The ratio of Reactive Power to the Maximum Capacity. The relationship between Power Factor and Q/Pmax is given by the formula:-</p> $\text{Power Factor} = \cos \left[\arctan \left[\frac{Q}{P_{\max}} \right] \right]$ <p>For example, a Power Park Module with a Q/P value of +0.33 would equate to a Power Factor of $\cos(\arctan 0.33) = 0.95$ Power Factor lag.</p>
Quiescent Physical Notification or QPN	Data that describes the MW levels to be deducted from the Physical Notification of a BM Unit to determine a resultant operating level to which the Dynamic Parameters associated with that BM Unit apply, and the associated times for such MW levels. The MW level of the QPN must always be set to zero.
Range CCGT Module	A CCGT Module where there is a physical connection by way of a steam or hot gas main between that CCGT Module and another CCGT Module or other CCGT Modules , which connection contributes (if open) to efficient modular operation, and which physical connection can be varied by the operator.
Rated Field Voltage	Shall have the meaning ascribed to that term in IEC 34-16-1:1991 [equivalent to British Standard BS4999 Section 116.1 : 1992].

Formatted: Font color: Auto

Formatted: Font color: Auto

Formatted: Font color: Auto, Highlight

Formatted: Font color: Auto, Highlight

Formatted: Font color: Auto, Highlight

Formatted: Font color: Auto, Highlight

Formatted: Font color: Auto, Highlight

Formatted: Font color: Auto, Highlight

Formatted: Font color: Auto, Highlight

Formatted: Font color: Auto, Highlight

Formatted: Font color: Auto, Highlight

Formatted: Font color: Auto, Highlight

Formatted: Font color: Auto, Highlight

Rated MW	The "rating-plate" MW output of a Power Generating Module, Generating Unit, Power Park Module, HVDC Converter or DC Converter , being: <ul style="list-style-type: none"> (a) that output up to which the Generating Unit was designed to operate (Calculated as specified in British Standard BS EN 60034 – 1: 1995); or (b) the nominal rating for the MW output of a Power Park Module or Power Generating Module being the maximum continuous electric output power which the Power Park Module or Power Generating Module was designed to achieve under normal operating conditions; or (c) the nominal rating for the MW import capacity and export capacity (if at a DC Converter Station or HVDC Converter Station) of a DC Converter or HVDC Converter.
Reactive Despatch Instruction	Has the meaning set out in the CUSC .
Reactive Despatch Network Restriction	A restriction placed upon an Embedded Power Generating Module, Embedded Generating Unit, Embedded Power Park Module or DC Converter at an Embedded DC Converter Station or HVDC Converter at an Embedded HVDC Converter Station by the Network Operator that prevents the Generator or DC Converter Station owner or HVDC System Owner in question (as applicable) from complying with any Reactive Despatch Instruction with respect to that Power Generating Module, Generating Unit, Power Park Module or DC Converter at a DC Converter Station or HVDC Converter at a HVDC Converter Station , whether to provide Mvars over the range referred to in CC 6.3.2, ECC.6.3.2 or otherwise.
Reactive Energy	The integral with respect to time of the Reactive Power .
Reactive Power	The product of voltage and current and the sine of the phase angle between them measured in units of voltamperes reactive and standard multiples thereof, ie: 1000 VAR = 1 kVAR 1000 kVAR = 1 Mvar
Record of Inter-System Safety Precautions or RISSP	A written record of inter-system Safety Precautions to be compiled in accordance with the provisions of OC8 .

Formatted: Font color: Auto, Highlight

Formatted: Font color: Auto, Highlight

Formatted: Font color: Auto, Highlight

Formatted: Font color: Auto

Formatted: Font color: Auto

Formatted: Font color: Auto, Highlight

<p>Registered Capacity</p>	<p>(a) In the case of a Generating Unit other than that forming part of a CCGT Module or Power Park Module or Power Generating Module, the normal full load capacity of a Generating Unit as declared by the Generator, less the MW consumed by the Generating Unit through the Generating Unit's Unit Transformer when producing the same (the resultant figure being expressed in whole MW, or in MW to one decimal place).</p> <p>(b) In the case of a CCGT Module or Power Park Module owned or operated by a GB Generator, the normal full load capacity of the CCGT Module or Power Park Module (as the case may be) as declared by the GB Generator, being the Active Power declared by the GB Generator as being deliverable by the CCGT Module or Power Park Module at the Grid Entry Point (or in the case of an Embedded CCGT Module or Power Park Module, at the User System Entry Point), expressed in whole MW, or in MW to one decimal place. For the avoidance of doubt Maximum Capacity would apply to Power Generating Modules which form part of a Large, Medium or Small Power Stations.</p> <p>(c) In the case of a Power Station, the maximum amount of Active Power deliverable by the Power Station at the Grid Entry Point (or in the case of an Embedded Power Station at the User System Entry Point), as declared by the Generator, expressed in whole MW, or in MW to one decimal place. The maximum Active Power deliverable is the maximum amount deliverable simultaneously by the Power Generating Modules and/or Generating Units and/or CCGT Modules and/or Power Park Modules less the MW consumed by the Power Generating Modules and/or Generating Units and/or CCGT Modules in producing that Active Power and forming part of a Power Station.</p> <p>(d) In the case of a DC Converter at a DC Converter Station or HVDC Converter at an HVDC Converter Station, the normal full load amount of Active Power transferable from a DC Converter or HVDC Converter at the Onshore Grid Entry Point (or in the case of an Embedded DC Converter Station or an Embedded HVDC Converter Station at the User System Entry Point), as declared by the DC Converter Station owner or HVDC System Owner, expressed in whole MW, or in MW to one decimal place.</p> <p>(e) In the case of a DC Converter Station or HVDC Converter Station, the maximum amount of Active Power transferable from a DC Converter Station or HVDC Converter Station at the Onshore Grid Entry Point (or in the case of an Embedded DC Converter Station or Embedded HVDC Converter Station at the User System Entry Point), as declared by the DC Converter Station owner or HVDC System Owner, expressed in whole MW, or in MW to one decimal place.</p>
-----------------------------------	---

Formatted: Font color: Auto, Highlight

Registered Data	Those items of Standard Planning Data and Detailed Planning Data which upon connection become fixed (subject to any subsequent changes).
Registered Import Capability	<p>In the case of a DC Converter Station or HVDC Converter Station containing DC Converters or HVDC Converters connected to an External System, the maximum amount of Active Power transferable into a DC Converter Station or HVDC Converter Station at the Onshore Grid Entry Point (or in the case of an Embedded DC Converter Station or Embedded HVDC Converter Station at the User System Entry Point), as declared by the DC Converter Station owner or HVDC System Owner, expressed in whole MW.</p> <p>In the case of a DC Converter or HVDC Converter connected to an External System and in a DC Converter Station or HVDC Converter Station, the normal full load amount of Active Power transferable into a DC Converter or HVDC Converter at the Onshore Grid Entry Point (or in the case of an Embedded DC Converter Station or Embedded HVDC Converter Station at the User System Entry Point), as declared by the DC Converter owner or HVDC System Owner, expressed in whole MW.</p>
Regulations	The Utilities Contracts Regulations 1996, as amended from time to time.
Reheater Time Constant	Determined at Registered Capacity , the reheater time constant will be construed in accordance with the principles of the IEEE Committee Report "Dynamic Models for Steam and Hydro Turbines in Power System Studies" published in 1973 which apply to such phrase.
Rejected Grid Code Modification Proposal	A Grid Code Modification Proposal in respect of which the Authority has decided not to direct The Company to modify the Grid Code pursuant to the Transmission Licence in the manner set out herein or, in the case of a Grid Code Self Governance Proposals , in respect of which the Grid Code Review Panel has voted not to approve.
Related Person	means, in relation to an individual, any member of his immediate family, his employer (and any former employer of his within the previous 12 months), any partner with whom he is in partnership, and any company or Affiliate of a company in which he or any member of his immediate family controls more than 20% of the voting rights in respect of the shares of the company;
Relevant E&W Transmission Licensee	As the context requires NGET and/or an E&W Offshore Transmission Licensee .
Relevant Party	Has the meaning given in GR15.10(a).
Relevant Scottish Transmission Licensee	As the context requires SPT and/or SHETL and/or a Scottish Offshore Transmission Licensee .

Formatted: Font color: Auto

Formatted: Font color: Auto, Highlight

Formatted: Highlight

Formatted: Font color: Auto, Highlight

Formatted: Highlight

Formatted: Font color: Auto, Highlight

Formatted: Highlight

Formatted: Font color: Auto, Highlight

Formatted: Highlight

Formatted: Font color: Auto, Highlight

Formatted: Highlight

Formatted: Font color: Auto, Highlight

Formatted: Highlight

Formatted: Font color: Auto, Highlight

Formatted: Highlight

Formatted: Font color: Auto, Highlight

Formatted: Highlight

Formatted: Font color: Auto, Highlight

Formatted: Highlight

Formatted: Font color: Auto, Highlight

Formatted: Highlight

Formatted: Font color: Auto, Highlight

Formatted: Highlight

Formatted: Font color: Auto, Highlight

Formatted: Highlight

Formatted: Font color: Auto, Highlight

Formatted: Highlight

Formatted: Font color: Auto, Highlight

Formatted: Highlight

Formatted: Font color: Auto, Highlight

Formatted: Highlight

Formatted: Font color: Auto, Highlight

Formatted: Highlight

Formatted: Font color: Auto, Highlight

Formatted: Highlight

Formatted: Font color: Auto, Highlight

Formatted: Highlight

Formatted: Font color: Auto, Highlight

Formatted: Highlight

Formatted: Font color: Auto, Highlight

Formatted: Highlight

Formatted: Font color: Auto, Highlight

Formatted: Highlight

Relevant Transmission Licensee	Means SP Transmission Ltd (SPT) in its Transmission Area or Scottish Hydro-Electric Transmission Ltd (SHELTL) in its Transmission Area or any Offshore Transmission Licensee in its Transmission Area .
Relevant Unit	As defined in the STC, Schedule 3 .
Remote End HVDC Converter Station	An HVDC Converter Station which forms part of an HVDC System and is not directly connected to the AC part of the GB Synchronous Area .
Remote Transmission Assets	Any Plant and Apparatus or meters owned by NGET which: <ul style="list-style-type: none"> (a) are Embedded in a User System and which are not directly connected by Plant and/or Apparatus owned by NGET to a sub-station owned by NGET; and (b) are by agreement between NGET and such User operated under the direction and control of such User.
Requesting Safety Co-ordinator	The Safety Co-ordinator requesting Safety Precautions .
Responsible Engineer/ Operator	A person nominated by a User to be responsible for System control.
Responsible Manager	A manager who has been duly authorised by a User or NGET to sign Site Responsibility Schedules on behalf of that User or NGET , as the case may be. For Connection Sites in Scotland and Offshore a manager who has been duly authorised by the Relevant Transmission Licensee to sign Site Responsibility Schedules on behalf of that Relevant Transmission Licensee .
Re-synchronisation	The bringing of parts of the System which have become Out of Synchronism with any other System back into Synchronism , and like terms shall be construed accordingly.
Safety Co-ordinator	A person or persons nominated by a Relevant E&W Transmission Licensee and each E&W User in relation to Connection Points (or in the case of OTSUA operational prior to the OTSUA Transfer Time, Transmission Interface Points) on an E&W Transmission System and/or by the Relevant Scottish Transmission Licensee and each Scottish User in relation to Connection Points (or in the case of OTSUA operational prior to the OTSUA Transfer Time, Transmission Interface Points) on a Scottish Transmission System to be responsible for the co-ordination of Safety Precautions at each Connection Point (or in the case of OTSUA operational prior to the OTSUA Transfer Time, Transmission Interface Points) when work (which includes testing) is to be carried out on a System which necessitates the provision of Safety Precautions on HV Apparatus (as defined in OC8A.1.6.2 and OC8B.1.7.2), pursuant to OC8 .
Safety From The System	That condition which safeguards persons when work is to be carried out on or near a System from the dangers which are inherent in the System .

Formatted: Font color: Auto, Highlight

Formatted: Font color: Auto, Highlight

Formatted: Font color: Auto, Highlight

Formatted: Font color: Auto, Highlight

Formatted: Font color: Auto, Highlight

Formatted: Font color: Auto, Highlight

Formatted: Font color: Auto

Formatted: Font color: Auto, Highlight

Formatted: Font color: Auto, Highlight

Formatted: Font color: Auto, Highlight

Safety Key	A key unique at the Location capable of operating a lock which will cause an Isolating Device and/or Earthing Device to be Locked .
Safety Log	A chronological record of messages relating to safety co-ordination sent and received by each Safety Co-ordinator under OC8 .
Safety Precautions	Isolation and/or Earthing .
Safety Rules	The rules of NET (in England and Wales) and the Relevant Transmission Licensee (in Scotland or Offshore) or a User that seek to ensure that persons working on Plant and/or Apparatus to which the rules apply are safeguarded from hazards arising from the System .
Scottish Offshore Transmission System	An Offshore Transmission System with an Interface Point in Scotland.
Scottish Offshore Transmission Licensee	A person who owns or operates a Scottish Offshore Transmission System pursuant to a Transmission Licence .
Scottish Transmission System	Collectively SPT's Transmission System and SHETL's Transmission System and any Scottish Offshore Transmission Systems .
Scottish User	A User in Scotland or any Offshore User who owns or operates Plant and/or Apparatus connected (or which will at the OTSUA Transfer Time be connected) to a Scottish Offshore Transmission System
Secondary Response	The automatic increase in Active Power output of a Genset or, as the case may be, the decrease in Active Power Demand in response to a System Frequency fall. This increase in Active Power output or, as the case may be, the decrease in Active Power Demand must be in accordance with the provisions of the relevant Ancillary Services Agreement which will provide that it will be fully available by 30 seconds from the time of the start of the Frequency fall and be sustainable for at least a further 30 minutes. The interpretation of the Secondary Response to a -0.5 Hz frequency change is shown diagrammatically in Figure CC.A.3.2 or Figure ECC.A.3.2.
Secretary of State	Has the same meaning as in the Act .
Secured Event	Has the meaning set out in the Security and Quality of Supply Standard .
Security and Quality of Supply Standard (SQSS)	The version of the document entitled 'Security and Quality of Supply Standard' established pursuant to the Transmission Licence in force at the time of entering into the relevant Bilateral Agreement .

Formatted: Font color: Auto, Highlight

Formatted: Font color: Auto, Highlight

Formatted: Font color: Auto, Highlight

Formatted: Font color: Auto, Highlight

Formatted: Font color: Auto, Highlight

Formatted: Font color: Auto, Highlight

Formatted: Font color: Auto

Formatted: Font color: Auto

Formatted: Font color: Auto, Highlight

Formatted: Font color: Auto, Highlight

Formatted: Font color: Auto, Highlight

Formatted: Font color: Auto, Highlight

Self-Governance Criteria	<p>A proposed Modification that, if implemented,</p> <p>(a) is unlikely to have a material effect on:</p> <ul style="list-style-type: none"> (i) existing or future electricity consumers; and (ii) competition in the generation, distribution, or supply of electricity or any commercial activities connected with the generation, distribution or supply of electricity; and (iii) the operation of the National Electricity Transmission System; and (iv) matters relating to sustainable development, safety or security of supply, or the management of market or network emergencies; and (v) the Grid Code's governance procedures or the Grid Code's modification procedures, and <p>(b) is unlikely to discriminate between different classes of Users.</p>
Self-Governance Modifications	<p>A Grid Code Modification Proposal that does not fall within the scope of a Significant Code Review and that meets the Self-Governance Criteria or which the Authority directs is to be treated as such any direction under GR.24.4.</p>
Self-Governance Statement	<p>The statement made by the Grid Code Review Panel and submitted to the Authority:</p> <p>(a) confirming that, in its opinion, the Self-Governance Criteria are met and the proposed Grid Code Modification Proposal is suitable for the Self-Governance route; and</p> <p>(b) providing a detailed explanation of the Grid Code Review Panel's reasons for that opinion</p>
Setpoint Voltage	<p>The value of voltage at the Grid Entry Point, or User System Entry Point if Embedded, on the automatic control system steady state operating characteristic, as a percentage of the nominal voltage, at which the transfer of Reactive Power between a Power Park Module, DC Converter, HVDC Converter or Non-Synchronous Generating Unit and the Transmission System, or Network Operator's system if Embedded, is zero.</p>
Settlement Period	<p>A period of 30 minutes ending on the hour and half-hour in each hour during a day.</p>
Seven Year Statement	<p>A statement, prepared by NGET in accordance with the terms of NGET's Transmission Licence, showing for each of the seven succeeding Financial Years, the opportunities available for connecting to and using the National Electricity Transmission System and indicating those parts of the National Electricity Transmission System most suited to new connections and transport of further quantities of electricity.</p>

Formatted: Font color: Auto, Highlight

Formatted: Font color: Auto, Highlight

Formatted: Font color: Auto, Highlight

Formatted: Font color: Auto, Highlight

Formatted: Font color: Auto, Highlight

Formatted: Font color: Auto, Highlight

SF₆ Gas Zone	A segregated zone surrounding electrical conductors within a casing containing SF ₆ gas.
SHETL	Scottish Hydro-Electric Transmission Limited
Shutdown	The condition of a Generating Unit where the generator rotor is at rest or on barring.
Significant Code Review	Means the period commencing on the start date of a Significant Code Review as stated in the notice issued by the Authority , and ending in the circumstances described in GR.16.6 or GR.16.7, as appropriate.
Significant Code Review Phase	Means the period commencing on the start date of a Significant Code Review as stated in the notice issued by the Authority , and ending in the circumstances described in GR.16.6 or GR.16.7, as appropriate.
Significant Incident	An Event which either: <ul style="list-style-type: none"> (a) was notified by a User to NGET under OC7, and which NGET considers has had or may have had a significant effect on the National Electricity Transmission System, and NGET requires the User to report that Event in writing in accordance with OC10 and notifies the User accordingly; or (b) was notified by NGET to a User under OC7, and which that User considers has had or may have had a significant effect on that User's System, and that User requires NGET to report that Event in writing in accordance with the provisions of OC10 and notifies NGET accordingly.
Simultaneous Tap Change	A tap change implemented on the generator step-up transformers of Synchronised Gensets , effected by Generators in response to an instruction from NGET issued simultaneously to the relevant Power Stations . The instruction, preceded by advance notice, must be effected as soon as possible, and in any event within one minute of receipt from NGET of the instruction.
Single Line Diagram	A schematic representation of a three-phase network in which the three phases are represented by single lines. The diagram shall include (but not necessarily be limited to) busbars, overhead lines, underground cables, power transformers and reactive compensation equipment. It shall also show where Large Power Stations are connected, and the points at which Demand is supplied.
Single Point of Connection	A single Point of Connection , with no interconnection through the User's System to another Point of Connection .
Site Common Drawings	Drawings prepared for each Connection Site (and in the case of OTSDUW, Transmission Interface Site) which incorporate Connection Site (and in the case of OTSDUW, Transmission Interface Site) layout drawings, electrical layout drawings, common protection/ control drawings and common services drawings.

Formatted: Font color: Auto, Highlight

Formatted: Font color: Auto, Highlight

Formatted: Font color: Auto, Highlight

Formatted: Font color: Auto, Highlight

Formatted: Font color: Auto, Highlight

Formatted: Font color: Auto, Highlight

Formatted: Font color: Auto, Highlight

Formatted: Font color: Auto, Highlight

Formatted: Font color: Auto, Highlight

Formatted: Font color: Auto, Highlight

Site Responsibility Schedule	A schedule containing the information and prepared on the basis of the provisions set out in Appendix 1 of the CC and Appendix E1 of the ECC.
Slope	The ratio of the steady state change in voltage, as a percentage of the nominal voltage, to the steady state change in Reactive Power output, in per unit of Reactive Power capability. For the avoidance of doubt, the value indicates the percentage voltage reduction that will result in a 1 per unit increase in Reactive Power generation.
Small Participant	Has the meaning given in the CUSC.

Formatted: Font color: Auto, Highlight

Formatted: Font color: Auto, Highlight

Formatted: Font color: Auto, Highlight

<p>Small Power Station</p>	<p>A Power Station which is</p> <p>(a) directly connected to:</p> <ul style="list-style-type: none"> (i) NGET's Transmission System where such Power Station has a Registered Capacity of less than 50MW; or (ii) SPT's Transmission System where such Power Station has a Registered Capacity of less than 30MW; or (iii) SHETL's Transmission System where such a Power Station has a Registered Capacity of less than 10 MW; or (iv) an Offshore Transmission System where such Power Station has a Registered Capacity of less than 10MW; <p>or,</p> <p>(b) Embedded within a User System (or part thereof) where such User System (or part thereof) is connected under normal operating conditions to:</p> <ul style="list-style-type: none"> (i) NGET's Transmission System and such Power Station has a Registered Capacity of less than 50MW; or (ii) SPT's Transmission System and such Power Station has a Registered Capacity of less than 30MW; or (iii) SHETL's Transmission System and such Power Station has a Registered Capacity of less than 10MW; <p>or,</p> <p>(c) Embedded within a User System (or part thereof) where the User System (or part thereof) is not connected to the National Electricity Transmission System, although such Power Station is in:</p> <ul style="list-style-type: none"> (i) NGET's Transmission Area and such Power Station has a Registered Capacity of less than 50MW; or (ii) SPT's Transmission Area and such Power Station has a Registered Capacity of less than 30MW; or (iii) SHETL's Transmission Area and such Power Station has a Registered Capacity of less than 10MW; <p>For the avoidance of doubt a Small Power Station could comprise of Type A, Type B, Type C or Type D Power Generating Modules.</p>
<p>Speeder Motor Setting Range</p>	<p>The minimum and maximum no-load speeds (expressed as a percentage of rated speed) to which the turbine is capable of being controlled, by the speeder motor or equivalent, when the Generating Unit terminals are on open circuit.</p>
<p>SPT</p>	<p>SP Transmission Limited</p>

Formatted: Font color: Auto, Highlight

Formatted: Font color: Auto, Highlight

Formatted: Font color: Auto, Highlight

Standard Contract Terms	The standard terms and conditions applicable to Ancillary Services provided by Demand Response Providers and published on the Website from time to time.
Standard Modifications	A Grid Code Modification Proposal that does not fall within the scope of a Significant Code Review subject to any direction by the Authority pursuant to GR.16.3 and GR.16.4, nor meets the Self-Governance Criteria subject to any direction by the Authority pursuant to GR.24.4 and in accordance with any direction under GR.24.2.
Standard Planning Data	The general data required by NGET under the PC. It is generally also the data which NGET requires from a new User in an application for a CUSC Contract, as reflected in the PC.
Start Time	The time named as such in an instruction issued by NGET pursuant to the BC.
Start-Up	The action of bringing a Generating Unit from Shutdown to Synchronous Speed.
Statement of Readiness	Has the meaning set out in the Bilateral Agreement and/or Construction Agreement.
Station Board	A switchboard through which electrical power is supplied to the Auxiliaries of a Power Station, and which is supplied by a Station Transformer. It may be interconnected with a Unit Board.
Station Transformer	A transformer supplying electrical power to the Auxiliaries of (a) a Power Station, which is not directly connected to the Generating Unit terminals (typical voltage ratios being 132/11kV or 275/11kV), or (b) a DC Converter Station or HVDC Converter Station.
STC Committee	The committee established under the STC.
Steam Unit	A Generating Unit whose prime mover converts the heat-energy in steam to mechanical energy.
Subtransmission System	The part of a User's System which operates at a single transformation below the voltage of the relevant Transmission System.
Substantial Modification	A Modification in relation to modernisation or replacement of the User's Main Plant and Apparatus which impacts its technical capabilities, which, following notification by the relevant User to NGET, results in substantial amendment to the Bilateral Agreement, and which need not have a Material Effect on NGET or a User.
Supergrid Voltage	Any voltage greater than 200kV.

Formatted: Not Highlight

Formatted: Font: Calibri, 11 pt

Formatted: Font: Bold

Formatted: Font: Bold

Formatted: Font: Bold

Formatted: Not Highlight

Formatted: Font color: Auto, Highlight

Formatted: Font color: Auto

Formatted: Font color: Auto, Highlight

Formatted: Font color: Auto, Highlight

Formatted: Font color: Auto, Highlight

Formatted: Font color: Auto, Highlight

Formatted: Font color: Auto, Highlight

Formatted: Font color: Auto, Highlight

Formatted: Font color: Auto, Highlight

Formatted: Font color: Auto, Highlight

Formatted: Font color: Auto

Formatted: Font: Not Bold

Formatted: Font: Not Bold

Formatted: Font color: Auto

Formatted: Font: Not Bold

Formatted: Font color: Auto

Formatted: Font color: Auto, Highlight

Supplier	<p>(a) A person supplying electricity under an Electricity Supply Licence; or</p> <p>(b) A person supplying electricity under exemption under the Act; in each case acting in its capacity as a supplier of electricity to Customers in Great Britain.</p>
Surplus	<p>A MW figure relating to a System Zone equal to the total Output Usable in the System Zone:</p> <p>(a) minus the forecast of Active Power Demand in the System Zone, and</p> <p>(b) minus the export limit in the case of an export limited System Zone, or</p> <p>plus the import limit in the case of an import limited System Zone, and</p> <p>(c) (only in the case of a System Zone comprising the National Electricity Transmission System) minus the Operational Planning Margin.</p> <p>For the avoidance of doubt, a Surplus of more than zero in an export limited System Zone indicates an excess of generation in that System Zone; and a Surplus of less than zero in an import limited System Zone indicates insufficient generation in that System Zone.</p>
Synchronised	<p>(a) The condition where an incoming Power Generating Module, Generating Unit or Power Park Module or DC Converter or HVDC Converter or System is connected to the busbars of another System so that the Frequencies and phase relationships of that Power Generating Module, Generating Unit, Power Park Module, DC Converter, HVDC Converter or System, as the case may be, and the System to which it is connected are identical, like terms shall be construed accordingly e.g. "Synchronism".</p> <p>(b) The condition where an importing BM Unit is consuming electricity.</p>
Synchronising Generation	The amount of MW (in whole MW) produced at the moment of synchronising.
Synchronising Group	A group of two or more Gensets) which require a minimum time interval between their Synchronising or De-Synchronising times.
Synchronous Area	An area covered by synchronously interconnected Transmission Licensees , such as the Synchronous Areas of Continental Europe, Great Britain, Ireland-Northern Ireland and Nordic and the power systems of Lithuania, Latvia and Estonia, together referred to as 'Baltic' which are part of a wider Synchronous Area ;

Formatted: Font color: Auto, Highlight

Formatted: Font color: Auto, Highlight

Formatted: Font color: Auto, Highlight

Formatted: Font color: Auto, Highlight

Formatted: Font color: Auto, Highlight

Formatted: Font color: Auto, Highlight

Synchronous Compensation	The operation of rotating synchronous Apparatus for the specific purpose of either the generation or absorption of Reactive Power.
Synchronous Generating Unit	Any Onshore Synchronous Generating Unit or Offshore Synchronous Generating Unit.
Synchronous Generating Unit Performance Chart	A diagram showing the Real Power (MW) and Reactive Power (MVAR) capability limits within which a Synchronous Generating Unit at its stator terminals (which is part of a Synchronous Power Generating Module) will be expected to operate under steady state conditions.
Synchronous Power-Generating Module	An indivisible set of installations which can generate electrical energy such that the frequency of the generated voltage, the generator speed and the frequency of network voltage are in a constant ratio and thus in synchronism. For the avoidance of doubt a Synchronous Power Generating Module could comprise of one or more Synchronous Generating Units
Synchronous Power Generating Module Matrix	The matrix described in Appendix 1 to BC1 under the heading Synchronous Power Generating Module Matrix.
Synchronous Power Generating Module Planning Matrix	A matrix in the form set out in Appendix 5 of OC2 showing the combination of Synchronous Generating Units within a Synchronous Power Generating Module which would be running in relation to any given MW output.
Synchronous Power Generating Unit	Has the same meaning as a Synchronous Generating Unit and would be considered to be part of a Power Generating Module.
Synchronous Speed	That speed required by a Generating Unit to enable it to be Synchronised to a System.
System	Any User System and/or the National Electricity Transmission System, as the case may be.
System Ancillary Services	Collectively Part 1 System Ancillary Services and Part 2 System Ancillary Services.
System Constraint	A limitation on the use of a System due to lack of transmission capacity or other System conditions.
System Constrained Capacity	That portion of Registered Capacity or Registered Import Capacity not available due to a System Constraint.
System Constraint Group	A part of the National Electricity Transmission System which, because of System Constraints, is subject to limits of Active Power which can flow into or out of (as the case may be) that part.

Formatted: Font color: Auto, Highlight

Formatted: Font color: Auto, Highlight

Formatted: Font color: Auto, Highlight

Formatted: Font color: Auto, Highlight

Formatted: Font color: Auto, Highlight

Formatted: Font color: Auto, Highlight

Formatted: Font color: Auto, Highlight

Formatted: Font color: Auto, Highlight

Formatted: Font color: Auto, Highlight

Formatted: Font color: Auto, Highlight

Formatted: Font color: Auto, Highlight

Formatted: Font color: Auto, Highlight

Formatted: Font color: Auto, Highlight

System Fault Dependability Index or Dp	<p>A measure of the ability of Protection to initiate successful tripping of circuit-breakers which are associated with a faulty item of Apparatus. It is calculated using the formula:</p> $Dp = 1 - F_1/A$ <p>Where:</p> <p>A = Total number of System faults</p> <p>F₁ = Number of System faults where there was a failure to trip a circuit-breaker.</p>
System Margin	<p>The margin in any period between</p> <p>(a) the sum of Maximum Export Limits and</p> <p>(b) forecast Demand and the Operating Margin, for that period.</p>
System Negative Reserve Active Power Margin or System NRAPM	<p>That margin of Active Power sufficient to allow the largest loss of Load at any time.</p>
System Operator - Transmission Owner Code or STC	<p>Has the meaning set out in NGET's Transmission Licence</p>
System Telephony	<p>An alternative method by which a User's Responsible Engineer/Operator and NGET Control Engineer(s) speak to one and another for the purposes of control of the Total System in both normal operating conditions and where practicable, emergency operating conditions.</p>
System Tests	<p>Tests which involve simulating conditions, or the controlled application of irregular, unusual or extreme conditions, on the Total System, or any part of the Total System, but which do not include commissioning or recommissioning tests or any other tests of a minor nature.</p>
System to Demand Intertrip Scheme	<p>An intertrip scheme which disconnects Demand when a System fault has arisen to prevent abnormal conditions occurring on the System.</p>
System to Generator Operational Intertripping	<p>A Balancing Service involving the initiation by a System to Generator Operational Intertripping Scheme of automatic tripping of the User's circuit breaker(s), or Relevant Transmission Licensee's circuit breaker(s) where agreed by NGET, the User and the Relevant Transmission Licensee, resulting in the tripping of BM Unit(s) or (where relevant) Generating Unit(s) comprised in a BM Unit to prevent abnormal system conditions occurring, such as over voltage, overload, System instability, etc, after the tripping of other circuit-breakers following power System fault(s).</p>

Formatted: Font color: Auto, Highlight

Formatted: Font color: Auto, Highlight

Formatted: Font color: Auto, Highlight

Formatted: Font color: Auto, Highlight

Formatted: Font color: Auto, Highlight

Formatted: Font color: Auto, Highlight

Formatted: Font color: Auto, Highlight

Formatted: Font color: Auto, Highlight

System to Generator Operational Intertripping Scheme	A System to Generating Unit or System to CCGT Module or System to Power Park Module or System to Power Generating Module Intertripping Scheme forming a condition of connection and specified in Appendix F3 of the relevant Bilateral Agreement , being either a Category 1 Intertripping Scheme , Category 2 Intertripping Scheme , Category 3 Intertripping Scheme or Category 4 Intertripping Scheme .
System Zone	A region of the National Electricity Transmission System within a described boundary or the whole of the National Electricity Transmission System , as further provided for in OC2.2.4, and the term "Zonal" will be construed accordingly.
Target Frequency	That Frequency determined by NGET , in its reasonable opinion, as the desired operating Frequency of the Total System . This will normally be 50.00Hz plus or minus 0.05Hz, except in exceptional circumstances as determined by NGET , in its reasonable opinion when this may be 49.90 or 50.10Hz. An example of exceptional circumstances may be difficulties caused in operating the System during disputes affecting fuel supplies.
Technical Specification	In relation to Plant and/or Apparatus , (a) the relevant European Specification ; or (b) if there is no relevant European Specification , other relevant standards which are in common use in the European Community.
Test Co-ordinator	A person who co-ordinates System Tests .
Test Panel	A panel, whose composition is detailed in OC12 , which is responsible, inter alia, for considering a proposed System Test , and submitting a Proposal Report and a Test Programme .
Test Programme	A programme submitted by the Test Panel to NGET , the Test Proposer , and each User identified by NGET under OC12.4.2.1, which states the switching sequence and proposed timings of the switching sequence, a list of those staff involved in carrying out the System Test (including those responsible for the site safety) and such other matters as the Test Panel deems appropriate.
Test Proposer	The person who submits a Proposal Notice .
Total Shutdown	The situation existing when all generation has ceased and there is no electricity supply from External Interconnections and, therefore, the Total System has shutdown with the result that it is not possible for the Total System to begin to function again without NGET's directions relating to a Black Start .
Total System	The National Electricity Transmission System and all User Systems in the National Electricity Transmission System Operator Area .
Trading Point	A commercial and, where so specified in the Grid Code, an operational interface between a User and NGET , which a User has notified to NGET .

Formatted: Font color: Auto, Highlight

Formatted: Font color: Auto, Highlight

Formatted: Font color: Auto, Highlight

Formatted: Font color: Auto, Highlight

Formatted: Font color: Auto, Highlight

Formatted: Font color: Auto, Highlight

Formatted: Font color: Auto, Highlight

Formatted: Font color: Auto, Highlight

Formatted: Font color: Auto, Highlight

Formatted: Font color: Auto

Formatted: Font color: Auto, Highlight

Transfer Date	Such date as may be appointed by the Secretary of State by order under section 65 of the Act .
Transmission	Means, when used in conjunction with another term relating to equipment or a site, whether defined or not, that the associated term is to be read as being part of or directly associated with the National Electricity Transmission System , and not of or with the User System .
Transmission Area	Has the meaning set out in the Transmission Licence of a Transmission Licensee .
Transmission DC Converter	Any Transmission Licensee Apparatus (or OTSUA that will become Transmission Licensee Apparatus at the OTSUA Transfer Time) used to convert alternating current electricity to direct current electricity, or vice versa. A Transmission Network DC Converter (which could include an HVDC System owned by an Offshore Transmission Licensee or Generator in respect of OTSUA) is a standalone operative configuration at a single site comprising one or more converter bridges, together with one or more converter transformers, converter control equipment, essential protective and switching devices and auxiliaries, if any, used for conversion.
Transmission Entry Capacity	Has the meaning set out in the CUSC .
Transmission Interface Circuit	In NGET's Transmission Area , a Transmission circuit which connects a System operating at a voltage above 132kV to a System operating at a voltage of 132kV or below In SHETL's Transmission Area and SPT's Transmission Area , a Transmission circuit which connects a System operating at a voltage of 132kV or above to a System operating at a voltage below 132kV.
Transmission Interface Point	means the electrical point of connection between the Offshore Transmission System and an Onshore Transmission System .
Transmission Interface Site	the site at which the Transmission Interface Point is located.
Transmission Licence	A licence granted under Section 6(1)(b) of the Act .
Transmission Licensee	Any Onshore Transmission Licensee or Offshore Transmission Licensee

Formatted: Font color: Auto, Highlight

Formatted: Font color: Auto

Formatted: Font color: Auto, Highlight

Formatted: Font color: Auto, Highlight

Formatted: Font color: Auto, Highlight

Formatted: Font color: Auto, Highlight

Formatted: Font color: Auto, Highlight

Formatted: Font color: Auto, Highlight

Formatted: Font color: Auto, Highlight

Formatted: Font color: Auto, Highlight

Transmission Site	In England and Wales, means a site owned (or occupied pursuant to a lease, licence or other agreement) by NGET in which there is a Connection Point . For the avoidance of doubt, a site owned by a User but occupied by NGET as aforesaid, is a Transmission Site . In Scotland and Offshore , means a site owned (or occupied pursuant to a lease, licence or other agreement) by a Relevant Transmission Licensee in which there is a Connection Point . For the avoidance of doubt, a site owned by a User but occupied by the Relevant Transmission Licensee as aforesaid, is a Transmission Site .
Transmission System	Has the same meaning as the term "licensee's transmission system" in the Transmission Licence of a Transmission Licensee .
Turbine Time Constant	Determined at Registered Capacity , the turbine time constant will be construed in accordance with the principles of the IEEE Committee Report "Dynamic Models for Steam and Hydro Turbines in Power System Studies" published in 1973 which apply to such phrase.
Type A Power Generating Module	A Power-Generating Module with a Grid Entry Point or User System Entry Point below 110 kV and a Maximum Capacity of 0.8 kW or greater but less than 1MW;
Type B Power Generating Module	A Power-Generating Module with a Grid Entry Point or User System Entry Point below 110 kV and a Maximum Capacity of 1MW or greater but less than 10MW;
Type C Power Generating Module	A Power-Generating Module with a Grid Entry Point or User System Entry Point below 110 kV and a Maximum Capacity of 10MW or greater but less than 50MW;
Type D Power Generating Module	A Power-generating Module : with a Grid Entry Point or User System Entry Point at, or greater than, 110 kV; or with a Grid Entry Point or User System Entry Point below 110 kV and with Maximum Capacity of 50MW or greater
Unbalanced Load	The situation where the Load on each phase is not equal.
Under-excitation Limiter	Shall have the meaning ascribed to that term in IEC 34-16-1:1991 [equivalent to British Standard BS4999 Section 116.1 : 1992].
Under Frequency Relay	An electrical measuring relay intended to operate when its characteristic quantity (Frequency) reaches the relay settings by decrease in Frequency .
Unit Board	A switchboard through which electrical power is supplied to the Auxiliaries of a Generating Unit and which is supplied by a Unit Transformer . It may be interconnected with a Station Board .
Unit Transformer	A transformer directly connected to a Generating Unit's terminals, and which supplies power to the Auxiliaries of a Generating Unit . Typical voltage ratios are 23/11kV and 15/6.6Kv.

Formatted: Font color: Auto, Highlight

Formatted: Font color: Auto

Formatted: Font color: Auto, Highlight

Formatted: Font color: Auto, Highlight

Formatted: Font color: Auto, Highlight

Formatted: Font color: Auto, Highlight

Formatted: Font color: Auto, Highlight

Formatted: Font color: Auto, Highlight

Formatted: Font color: Auto, Highlight

Formatted: Font color: Auto, Highlight

Formatted: Font color: Auto, Highlight

Formatted: Font color: Auto, Highlight

Unit Load Controller Response Time Constant	The time constant, expressed in units of seconds, of the power output increase which occurs in the Secondary Response timescale in response to a step change in System Frequency .
Unresolved Issues	Any relevant Grid Code provisions or Bilateral Agreement requirements identified by NGET with which the relevant User has not demonstrated compliance to NGET's reasonable satisfaction at the date of issue of the Preliminary Operational Notification and/or Interim Operational Notification and/or Limited Operational Notification and which are detailed in such Preliminary Operational Notification and/or Interim Operational Notification and/or Limited Operational Notification .
Urgent Modification	A Grid Code Modification Proposal treated or to be treated as an Urgent Modification in accordance with GR.23.
User	A term utilised in various sections of the Grid Code to refer to the persons using the National Electricity Transmission System , as more particularly identified in each section of the Grid Code concerned. In the Preface and the General Conditions the term means any person to whom the Grid Code applies. The term User includes an EU Code User and a GB Code User .
User Data File Structure	The file structure given at DRC 18 which will be specified by NGET which a Generator or DC Converter Station owner or HVDC System Owner must use for the purposes of CP to submit DRC data Schedules and information demonstrating compliance with the Grid Code and, where applicable, with the CUSC Contract(s) , unless otherwise agreed by NGET.
User Development	In the PC means either User's Plant and/or Apparatus to be connected to the National Electricity Transmission System , or a Modification relating to a User's Plant and/or Apparatus already connected to the National Electricity Transmission System , or a proposed new connection or Modification to the connection within the User System .
User Self Certification of Compliance	A certificate, in the form attached at CP.A.2.(1) or ECP.A.2.(1) completed by a Generator or DC Converter Station owner or HVDC System Owner to which the Compliance Statement is attached which confirms that such Plant and Apparatus complies with the relevant Grid Code provisions and where appropriate, with the CUSC Contract(s) , as identified in the Compliance Statement and, if appropriate, identifies any Unresolved Issues and/or any exceptions to such compliance and details the derogation(s) granted in respect of such exceptions.

Formatted: Font color: Auto, Highlight

Formatted: Font color: Auto, Highlight

Formatted: Font color: Auto, Highlight

Formatted: Font color: Auto

Formatted: Font color: Auto

Formatted: Font color: Auto

Formatted: Font color: Auto

Formatted: Font color: Auto

Formatted: Font color: Auto

User Site	<p>In England and Wales, a site owned (or occupied pursuant to a lease, licence or other agreement) by a User in which there is a Connection Point. For the avoidance of doubt, a site owned by NGET but occupied by a User as aforesaid, is a User Site.</p> <p>In Scotland and Offshore, a site owned (or occupied pursuant to a lease, licence or other agreement) by a User in which there is a Connection Point. For the avoidance of doubt, a site owned by a Relevant Transmission Licensee but occupied by a User as aforesaid, is a User Site.</p>
User System	<p>Any system owned or operated by a User comprising:-</p> <p>(a) Power Generating Modules or Generating Units; and/or</p> <p>(b) Systems consisting (wholly or mainly) of electric lines used for the distribution of electricity from Grid Supply Points or Generating Units or Power Generating Modules or other entry points to the point of delivery to Customers, or other Users;</p> <p>and Plant and/or Apparatus Apparatus (including prior to the OTSUA Transfer Time, any OTSUA) connecting:-</p> <p>(c) The system as described above; or</p> <p>(d) Non-Embedded Customers equipment;</p> <p>to the National Electricity Transmission System or to the relevant other User System, as the case may be.</p> <p>The User System includes any Remote Transmission Assets operated by such User or other person and any Plant and/or Apparatus and meters owned or operated by the User or other person in connection with the distribution of electricity but does not include any part of the National Electricity Transmission System.</p>
User System Entry Point	<p>A point at which a Power Generating Module, Generating Unit, a CCGT Module or a CCGT Unit or a Power Park Module or a DC Converter or an HVDC Converter, as the case may be, which is Embedded connects to the User System.</p>
Water Time Constant	<p>Bears the meaning ascribed to the term "Water inertia time" in IEC308.</p>
Website	<p>The site established by NGET on the World-Wide Web for the exchange of information among Users and other interested persons in accordance with such restrictions on access as may be determined from time to time by NGET.</p>

Formatted: Font color: Auto

Formatted: Font color: Auto

Formatted: Font color: Auto, Highlight

Formatted: Font color: Auto, Highlight

Formatted: Font color: Auto

Weekly ACS Conditions	Means that particular combination of weather elements that gives rise to a level of peak Demand within a week, taken to commence on a Monday and end on a Sunday, which has a particular chance of being exceeded as a result of weather variation alone. This particular chance is determined such that the combined probabilities of Demand in all weeks of the year exceeding the annual peak Demand under Annual ACS Conditions is 50%, and in the week of maximum risk the weekly peak Demand under Weekly ACS Conditions is equal to the annual peak Demand under Annual ACS Conditions .
WG Consultation Alternative Request	Any request from an Authorised Electricity Operator ; the Citizens Advice or the Citizens Advice Scotland , NGET or a Materially Affected Party for a Workgroup Alternative Grid Code Modification to be developed by the Workgroup expressed as such and which contains the information referred to at GR.20.13. For the avoidance of doubt any WG Consultation Alternative Request does not constitute either a Grid Code Modification Proposal or a Workgroup Alternative Grid Code Modification
Workgroup	a Workgroup established by the Grid Code Review Panel pursuant to GR.20.1;
Workgroup Consultation	as defined in GR.20.10, and any further consultation which may be directed by the Grid Code Review Panel pursuant to GR.20.17;
Workgroup Alternative Grid Code Modification	an alternative modification to the Grid Code Modification Proposal developed by the Workgroup under the Workgroup terms of reference (either as a result of a Workgroup Consultation or otherwise) and which is believed by a majority of the members of the Workgroup or by the chairman of the Workgroup to better facilitate the Grid Code Objectives than the Grid Code Modification Proposal or the current version of version of the Grid Code ;
Zonal System Security Requirements	That generation required, within the boundary circuits defining the System Zone , which when added to the secured transfer capability of the boundary circuits exactly matches the Demand within the System Zone .

Formatted: Font color: Auto, Highlight

Formatted: Font color: Auto, Highlight

Formatted: Font color: Auto, Highlight

Formatted: Font color: Auto, Highlight

Formatted: Font color: Auto, Highlight

Formatted: Font color: Auto, Highlight

Formatted: Font color: Auto, Highlight

A number of the terms listed above are defined in other documents, such as the **Balancing and Settlement Code** and the **Transmission Licence**. Appendix 1 sets out the current definitions from the other documents of those terms so used in the Grid Code and defined in other documents for ease of reference, but does not form part of the Grid Code.

Formatted: Font color: Auto, Highlight

GD.2 Construction of References

GD.2.1 In the Grid Code:

- (i) a table of contents, a Preface, a Revision section, headings, and the Appendix to this **Glossary and Definitions** are inserted for convenience only and shall be ignored in construing the Grid Code;
- (ii) unless the context otherwise requires, all references to a particular paragraph, subparagraph, Appendix or Schedule shall be a reference to that paragraph, subparagraph Appendix or Schedule in or to that part of the Grid Code in which the reference is made;
- (iii) unless the context otherwise requires, the singular shall include the plural and vice versa, references to any gender shall include all other genders and references to persons shall include any individual, body corporate, corporation, joint venture, trust, unincorporated association, organisation, firm or partnership and any other entity, in each case whether or not having a separate legal personality;
- (iv) references to the words "include" or "including" are to be construed without limitation to the generality of the preceding words;
- (v) unless there is something in the subject matter or the context which is inconsistent therewith, any reference to an Act of Parliament or any Section of or Schedule to, or other provision of an Act of Parliament shall be construed at the particular time, as including a reference to any modification, extension or re-enactment thereof then in force and to all instruments, orders and regulations then in force and made under or deriving validity from the relevant Act of Parliament;
- (vi) where the **Glossary and Definitions** refers to any word or term which is more particularly defined in a part of the Grid Code, the definition in that part of the Grid Code will prevail (unless otherwise stated) over the definition in the **Glossary & Definitions** in the event of any inconsistency;
- (vii) a cross-reference to another document or part of the Grid Code shall not of itself impose any additional or further or co-existent obligation or confer any additional or further or co-existent right in the part of the text where such cross-reference is contained;
- (viii) nothing in the Grid Code is intended to or shall derogate from **NGET's** statutory or licence obligations;
- (ix) a "holding company" means, in relation to any person, a holding company of such person within the meaning of section 736, 736A and 736B of the Companies Act 1985 as substituted by section 144 of the Companies Act 1989 and, if that latter section is not in force at the **Transfer Date**, as if such latter section were in force at such date;
- (x) a "subsidiary" means, in relation to any person, a subsidiary of such person within the meaning of section 736, 736A and 736B of the Companies Act 1985 as substituted by section 144 of the Companies Act 1989 and, if that latter section is not in force at the **Transfer Date**, as if such latter section were in force at such date;
- (xi) references to time are to London time; and
- (xii) (a) Save where (b) below applies, where there is a reference to an item of data being expressed in a whole number of MW, fractions of a MW below 0.5 shall be rounded down to the nearest whole MW and fractions of a MW of 0.5 and above shall be rounded up to the nearest whole MW;

(b) In the case of the definition of **Registered Capacity** or **Maximum Capacity**, fractions of a MW below 0.05 shall be rounded down to one decimal place and fractions of a MW of 0.05 and above shall be rounded up to one decimal place.

Formatted: Font color: Auto

(xiii) For the purposes of the Grid Code, physical quantities such as current or voltage are not defined terms as their meaning will vary depending upon the context of the obligation. For example, voltage could mean positive phase sequence root mean square voltage, instantaneous voltage, phase to phase voltage, phase to earth voltage. The same issue equally applies to current, and it therefore the terms current and voltage should remain undefined with the meaning depending upon the context of the application. European Regulation (EU) 2016/631 defines requirements of current and voltage but they have not been adopted as part of EU implementation for the reasons outlined above.

< END OF GLOSSARY & DEFINITIONS >

Formatted: Font color: Auto

DCC Implementation in GB

Demand Response Services



Guidance Notes
April 2018

Summary

- Aims
- Background
- Application
- Scope
- DCC – Demand Response Services
- Current GB Practice
- Current GB Practice – Examples
- DCC Implementation in GB
- Linkage between National Grid’s Balancing Services (Ancillary Services) and DCC – Demand Response Services
- Additional Information – National Grid’s Balancing Services (Ancillary Services)
- Summary

Aims

- These slides are aimed at providing guidance in relation to the interpretation and implementation of the Demand Response elements of the EU Demand Connection Code
- National Grid want to make sure that in implementing these requirements, the process and principles are clear and unambiguous
- The general approach adopted is to maintain the current GB arrangements unless there is good reason not to do so (ie where the current GB requirements conflict with the proposed European requirements).
- This presentation will concentrate on Demand Response Services and will not cover the wider aspects of DCC

Background

- The Demand Connection Code (DCC) is one of three EU connection codes introduced under the European Third Energy Package
- The European Energy Third Energy Package aims to promote cross border trade in gas and electricity which consequently has driven a need for consistent requirements across European Member States
- The DCC which is one of the Codes under the European Energy Third Package, which was signed into European law (ie Entered Into Force (EIF)) on 7th September 2016 and will therefore supersede GB law
- Under the requirements of the Energy Third Package, DCC shall apply 3 years after the Entry Into Force Date (EIF) (ie 7 September 2019) and needs to be submitted to the Regulator for approval at least 2 years after EIF. (ie the DCC needs to be submitted to Ofgem for approval before 7 September 2018).

Application

- DCC applies to
 - New Transmission Connected Demand Facilities
 - *(ie a Non Embedded Customer)*
 - New Transmission Connected Distribution Facilities
 - *(ie a DNO with a new Grid Supply Point)*
 - New Distribution Systems including new closed distribution systems
 - *(ie a completely new Distribution System)*
 - New Demand Units used by a Demand Facility or a closed distribution system to provide demand response services to Relevant System Operators and relevant TSO's
 - *(ie new demand units (which could include an aggregator of new demand units) to provide a demand response service)*
- The requirements do not apply retrospectively unless one of the above parties makes a Substantial Modification

Scope

- DCC comprises of three parts
 - Requirements for Transmission Connected Demand (Articles 12 – 21)
 - Demand Response Requirements (Articles 27 – 30)
 - Compliance
 - Operational Notification Procedures (Articles 22 – 26 and Articles 31 - 35)
 - Compliance Testing (Articles 36 – 41)
 - Compliance Simulation (Articles 42 – 47)

DCC - Demand Response Services

Connection of demand units used by a demand facility, a closed distribution system or aggregator to provide demand response services to System Operators

Lists five categories that demand services should be grouped into:

Remotely Controlled (Art 28)	Autonomously controlled
Demand response active power control	Demand response system frequency control (Art 29)
Demand response reactive power control	Demand response very fast active power control (Art 30)
Demand response transmission constraint management	
Others	

DCC - Demand Response Services

- The Demand Response Services listed aren't exclusive and do not prevent other services existing/being developed or offered
- Article 27 – 30 lists the high level technical requirements associated with each service – it does not specify how these services should be commercially facilitated.
- Demand Response Services aren't mandatory – NGET will procure services that sit within these categories and demand providers can choose to offer them. If they do, they must meet the technical requirements specified in DCC for that particular category.

-
- Under the current GB arrangements (pre DCC) there are two routes for demand parties to interface to National Grid
 - *i) A party “Uses” the National Electricity Transmission System (ie the connectee becomes a CUSC party) and required to comply with the applicable requirements of the Grid Code. Demand User’s do not need to provide Mandatory Ancillary Services*
 - *ii) A party (who is embedded (eg connects to the Distribution System)) offers a commercial service (eg a Balancing Service) to National Grid with the contractual arrangements including the commercial and technical requirements being covered in the Ancillary Services agreement. The Ancillary Services agreements are governed through Transmission Licence Condition C16 and the Standard Contract Terms (STC)*
 - There is no reason why a CUSC Party cannot also offer commercial Ancillary Services (ie a Balancing Service) which would be governed under the auspices of Licence Condition C16 and the Standard Contract Terms

Current GB Practice

- *Balancing Services*

-
- Under NGET's Transmission License a Balancing Service is defined as:-
 - (a) **Ancillary Services**;
 - (b) Offers and Bids made in the **Balancing Mechanism**; and
 - (c) other services available to the licensee which serve to assist **NGET** in co-ordinating and directing the flow of electricity onto and over the **GB Transmission System** in accordance with the **Act** or the standard conditions and/or in doing so efficiently and economically, but shall not include anything provided by another **Transmission Licensee** pursuant to the **STC**.
 - Information on National Grid's Market, Operation and data is available from the following link
 - <https://www.nationalgrid.com/uk/electricity/market-operations-and-data>
 - National Grid publishes details of these Balancing Services (Ancillary Services) on its website. These are Commercial Services which NGET are interested in procuring and are available from the National Grid Website via the following link.
 - <https://www.nationalgrid.com/uk/electricity/balancing-services>
 - There is a significant volume of information on the National Grid website which provides links to the various Ancillary Services that National Grid is interested in procuring.

- *Balancing Services – Example (1)*

- Taking an example – if you were a Demand Response Provider looking to offer Firm Frequency Response services – you can click on the Firm Frequency Response requirements link as follows:-
- <https://www.nationalgrid.com/uk/electricity/balancing-services/frequency-response-services/firm-frequency-response>
- From the website that comes up, there is a panel which provides an interactive Guidance Note on Firm Frequency Response which can be accessed from the following link
- <https://www.nationalgrid.com/sites/default/files/documents/Firm%20Frequency%20Response%20%28FFR%29%20Interactive%20Guidance%20v1%200.pdf>
- This example provides a whole range of information on the Firm Frequency Response products available under this service including the connection and tender process

- *Balancing Services – Example - Continued (2)*

- Ultimately, if a provider (ie a Non CUSC Party) is interested in offering a Commercial Service they will ultimately have to sign an Ancillary Services agreement.
- This agreement is governed under Transmission Licence Condition C16 and the Standard Contract Terms (SCT's) which defines the form of the contract.
- If you click on the “Key Documents” link on Slide 9 – it will take you to the key documents such as the FFR Standard Contract Terms which is available from the following link
- https://www.nationalgrid.com/sites/default/files/documents/FFR%20SCTs%20-%20Issue%208%20Feb%201st%202017_0.pdf
- This will detail an example of the typical contract for the technical and commercial requirements dependent upon the type of firm frequency response service to be provided.

DCC Implementation in GB (1)

- DCC defines the very high level requirements for demand response services
- As part of the GC0104 workgroup, the majority view was for the DCC requirements to be included in the Grid Code rather than Licence Condition C16
- In addition, following the GC0104 consultation there was general support to keep the DCC requirements in the Grid Code as high level as possible
- In practice, the requirements for Demand Response Services in the DCC are so high level that it seems appropriate to retain the existing process in GB (ie C16 and the SCT) with the DCC requirements forming a wrapper around the already existing process

DCC Implementation in GB (2)

- As a consequence, the DCC requirements have been incorporated into a Standalone section of the Grid Code which applies only to Demand Response Providers. It would only apply to User's (ie a CUSC Party) if such a User wished to also provide a Demand Response Service.
- The Standard Contract Terms will need to be updated, such that as a condition of the contract, it will require Demand Response Providers to meet the DRSC (ie the Demand Response Requirements which is a standalone section of the Grid Code)
- The advantage of this approach is that it prevents significant duplication of requirements in the Grid Code and Standard Contract Terms
- Additionally, many of the technical requirements required for a Demand Response Provider will vary depending upon the type of service being offered, for example a Demand Response Provider offering a fully dynamic frequency response service will have very different requirements (eg instruction facilities, data requirements, control capability and data requirements) from say a Demand Response Provider who is providing a static service (ie one where its demand trips off when the System frequency falls below a defined setting (eg 49.5Hz))

Linkage between National Grid's Balancing Services (Ancillary Services) and DCC – Demand Response Services

DEMAND RESPONSE SERVICE	BALANCING SERVICE
Demand Response Active Power Control	All non-dynamic frequency response products All reserve products
Demand Response Reactive Power Control	Any reactive power service
Demand Response Transmission Constraint Management	Any constraint service on the Transmission network
Demand Response System Frequency Control	All dynamic frequency response products
Demand Response Very Fast Active Power Control	Any frequency response product faster than Demand Response Active Power Control and Frequency Control

Additional Information – National Grid’s Balancing Services (Ancillary Services)

nationalgrid

- Firm Frequency Response – Non Dynamic and Dynamic
 - <https://www.nationalgrid.com/uk/electricity/balancing-services/frequency-response-services/firm-frequency-response>
- Short Term Operating Reserve
 - <https://www.nationalgrid.com/uk/electricity/balancing-services/reserve-services/short-term-operating-reserve-stor>
- Demand Turn Up
 - <https://www.nationalgrid.com/uk/electricity/balancing-services/reserve-services/demand-turn>
- Demand Side Response
 - <https://www.nationalgrid.com/uk/electricity/balancing-services/demand-side-response-dsr>
- Enhanced Frequency Response
 - <https://www.nationalgrid.com/uk/electricity/balancing-services/frequency-response-services/enhanced-frequency-response-efr>
- Fast Reserve
 - <https://www.nationalgrid.com/uk/electricity/balancing-services/reserve-services/fast-reserve>

Summary (1)

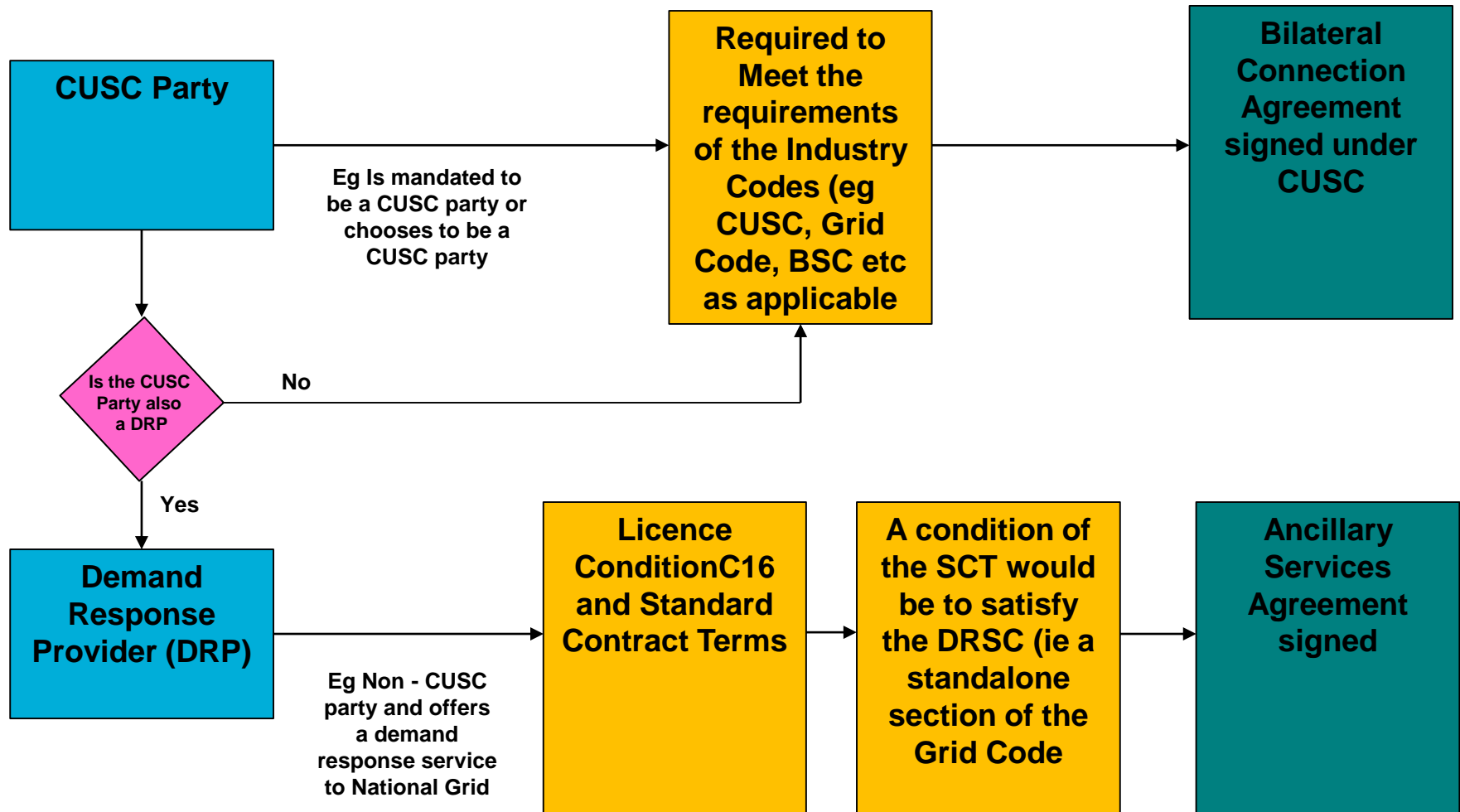

Summary (2)

- In summary, the Demand Response Services provisions in DCC is believed to complement the existing process for Ancillary Services in GB
- DCC has been implemented as a standalone section of the GG Grid Code. It would only apply to Demand Response Providers through a change to the Standard Contract Terms
- It is believed that the Demand Response Services in DCC already map to National Grid's existing Ancillary Services
- Further information on National Grid's Ancillary Services (Balancing Services) are available on the National Grid's Website
- Some further work is required on the Standard Contract Terms and general guidance relating to a number of other Ancillary Services other than Frequency Response. Work is in hand to implement this.
- It is believed this approach is the most efficient in creating maximum flexibility and minimising duplication