

**COMPLIANCE PROCESSES  
(CP)**

**CONTENTS**

(This contents page does not form part of the Grid Code)

<u>Paragraph No/Title</u>	<u>Page Number</u>
CP.1 INTRODUCTION.....	2
CP.2 OBJECTIVE.....	2
CP.3 SCOPE.....	2
CP.4 CONNECTION PROCESS.....	3
CP.5 ENERGISATION OPERATIONAL NOTIFICATION.....	3
CP.6 INTERIM OPERATIONAL NOTIFICATION.....	4
CP.7 FINAL OPERATIONAL NOTIFICATION.....	7
CP.8 LIMITED OPERATIONAL NOTIFICATION.....	9
CP.9 PROCESSES RELATING TO DEROGATIONS.....	12
CP.10 MANUFACTURER'S DATA & PERFORMANCE REPORT.....	12
APPENDIX 1 - ILLUSTRATIVE PROCESS DIAGRAMS.....	15
APPENDIX 2 - USER SELF CERTIFICATION OF COMPLIANCE.....	20
APPENDIX 3 - SIMULATION STUDIES.....	21

CP.1 INTRODUCTION

CP.1.1 The **Compliance Processes** ("CP") specifies:

the process (leading to an **Energisation Operational Notification**) which must be followed by **NGET** and any **GB Code User** to demonstrate its compliance with the Grid Code in relation to its **Plant** and **Apparatus** (including **OTSUA**) prior to the relevant **Plant** and **Apparatus** (including any **OTSUA**) being energised.

the process (leading to an **Interim Operational Notification** and **Final Operational Notification**) which must be followed by **NGET** and any **Generator** or **DC Converter Station** owner to demonstrate its compliance with the Grid Code in relation to its **Plant** and **Apparatus** (including any dynamically controlled **OTSUA**). This process shall be followed prior to and during the course of the relevant **Plant** and **Apparatus** (including **OTSUA**) being energised and **Synchronised**.

the process (leading to a **Limited Operational Notification**) which must be followed by **NGET** and each **Generator** and **DC Converter Station** owner where any of its **Plant** and/or **Apparatus** (including any **OTSUA**) becomes unable to comply with relevant provisions of the Grid Code, and where applicable with Appendices F1 to F5 (and in the case of **OTSUA**, Appendices OF1 to OF5 of the **Bilateral Agreement**). This process also includes when changes or **Modifications** are made to **Plant** and/or **Apparatus** (including **OTSUA**). This process applies to such **Plant** and/or **Apparatus** after the **Plant** and/or **Apparatus** has become **Operational** and until **Disconnected** from the **Total System**, (or until, in the case of **OTSUA**, the **OTSUA Transfer Time**), when changes or **Modifications** are made.

CP.1.2 As used in this **CP** references to **OTSUA** means **OTSUA** to be connected or connected to the **National Electricity Transmission System** prior to the **OTSUA Transfer Time**.

CP.1.3 Where the **Generator** or **DC Converter Station Owner** and/or **NGET** are required to apply for a derogation from the **Authority**, this is not in respect of the **OTSUA**

CP.2 OBJECTIVE

CP.2.1 The objective of the **CP** is to ensure that there is a clear and consistent process for demonstration of compliance by **GB Code Users** with the **Connection Conditions** and **Bilateral Agreement** which are similar for all **GB Code Users** of an equivalent category and will enable **NGET** to comply with its statutory and **Transmission Licence** obligations.

CP.2.2 Provisions of the **CP** which apply in relation to **OTSDUW** and **OTSUA** shall (in any particular case) apply up to the **OTSUA Transfer Time**, whereupon such provisions shall (without prejudice to any prior non-compliance) cease to apply.

CP.2.3 In relation to **OTSDUW**, provisions otherwise to be contained in a **Bilateral Agreement** may be contained in the **Construction Agreement**, and accordingly a reference in the **CP** to a relevant **Bilateral Agreement** includes the relevant **Construction Agreement**.

CP.3 SCOPE

CP.3.1 The **CP** applies to **NGET** and to **GB Code Users**, which in the **CP** means:

- (a) **GB Generators** (other than in relation to **Embedded Small Power Stations** or **Embedded Medium Power Stations** not subject to a **Bilateral Agreement**) including those undertaking **OTSDUW**.
- (b) **Network Operators**;
- (c) **Non-Embedded Customers**;
- (d) **DC Converter Station** owners (other than those which only have **Embedded DC Converter Stations** not subject to a **Bilateral Agreement**).

CP.3.2 The above categories of **GB Code User** will become bound by the **CP** prior to them generating, distributing, supplying or consuming, or in the case of **OTSUA**, transmitting, as the case may be, and references to the various categories should, therefore, be taken as referring to them in that prospective role as well as to **Users** actually connected.

CP3.3 This **CP** does not apply to **EU Code Users** for whom the requirements of the **ECP** applies.

#### CP.4 CONNECTION PROCESS

CP.4.1 The **CUSC Contract(s)** contain certain provisions relating to the procedure for connection to the **National Electricity Transmission System** or, in the case of **Embedded Power Stations** or **Embedded DC Converter Stations**, becoming operational and include provisions to be complied with by **GB Code Users** prior to and during the course of **NGET** notifying the **User** that it has the right to become operational. In addition to such provisions this **CP** sets out in further detail the processes to be followed to demonstrate compliance. Whilst this **CP** does not expressly address the processes to be followed in the case of **OTSUA** connecting to a **Network Operator's User System** prior to the **OTSUA Transfer Time**, the processes to be followed by **NGET** and the **Generator** in respect of **OTSUA** in such circumstances shall be consistent with those set out below by reference **OTSUA** directly connected to the **National Electricity Transmission System**.

CP.4.2 The provisions contained in CP.5 to CP.7 detail the process to be followed in order for the **GB Code User's Plant and Apparatus** (including **OTSUA**) to become operational. This process includes **EON** (energisation) **ION** (interim synchronising) and **FON** (final).

CP.4.2.1 The provisions contained in CP.5 relate to the connection and energisation of **User's Plant and Apparatus** (including **OTSUA**) to the **National Electricity Transmission System** or where **Embedded**, to a **User's System** and is shown diagrammatically at CP.A.1.1.

CP.4.2.2 The provisions contained in CP.6 and CP.7 provide the process for **Generators** and **DC Converter Station** owners to demonstrate compliance with the Grid Code and with, where applicable, the **CUSC Contract(s)** prior to and during the course of such **Generator's** or **DC Converter Station** owner's **Plant and Apparatus** (including **OTSUA** up to the **OTSUA Transfer Time**) becoming operational and is shown diagrammatically at CP.A.1.2 and CP.A.1.3.

CP.4.2.3 The provisions contained in CP.8 detail the process to be followed when:

- (a) a **Generator** or **DC Converter Station** owner's **Plant** and/or **Apparatus** (including the **OTSUA**) is unable to comply with any provisions of the Grid Code and **Bilateral Agreement**; or,
- (b) following any notification by a **Generator** or a **DC Converter Station** owner under the **PC** of any change to its **Plant and Apparatus** (including any **OTSUA**); or,
- (c) a **Modification** to a **Generator** or a **DC Converter Station** owner's **Plant** and/or **Apparatus**.

The process is shown diagrammatically at Appendix CP.A.1.4 for condition (a) and Appendix CP.A.1.5 for conditions (b) and (c)

#### CP.4.3 Embedded Medium Power Stations not subject to a Bilateral Agreement and Embedded DC Converter Stations not subject to a Bilateral Agreement

CP.4.3.1 For the avoidance of doubt the process in this **CP** does not apply to **Embedded Medium Power Stations** not subject to a **Bilateral Agreement** and **Embedded DC Converter Stations** not subject to a **Bilateral Agreement**.

#### CP.5 ENERGISATION OPERATIONAL NOTIFICATION

CP.5.1 The following provisions apply in relation to the issue of an **Energisation Operational Notification**.

- CP.5.1.1 Certain provisions relating to the connection and energisation of the **GB Code User's Plant and Apparatus** at the **Connection Site** and **OTSUA** at the **Transmission Interface Point** and in certain cases of **Embedded Plant and Apparatus** are specified in the **CUSC** and/or **CUSC Contract(s)**. For other **Embedded Plant and Apparatus** the **Distribution Code**, the **DCUSA** and the **Embedded Development Agreement** for the connection specify equivalent provisions. Further detail on this is set out in CP.5 below.
- CP.5.2 The items for submission prior to the issue of an **Energisation Operational Notification** are set out in CC.5.2
- CP.5.3 In the case of a **Generator** or **DC Converter Station** owner the items referred to in CC.5.2 shall be submitted using the **User Data File Structure**.
- CP.5.4 Not less than 28 days, or such shorter period as may be acceptable in **NGET's** reasonable opinion, prior to the **GB Code User** wishing to energise its **Plant and Apparatus** (including passive **OTSUA**) for the first time the **GB Code User** will submit to **NGET** a Certificate of Readiness to Energise **High Voltage** Equipment which specifies the items of **Plant and Apparatus** (including **OTSUA**) ready to be energised in a form acceptable to **NGET**.
- CP.5.5 If the relevant obligations under the provisions of the **CUSC** and/or **CUSC Contract(s)** and the conditions of CP.5 have been completed to **NGET's** reasonable satisfaction then **NGET** shall issue an **Energisation Operational Notification**. Any dynamically controlled reactive compensation **OTSUA** (including Statcoms or Static Var Compensators) shall not be **Energised** until the appropriate **Interim Operational Notification** has been issued in accordance with CP.6.
- CP.6 INTERIM OPERATIONAL NOTIFICATION
- CP.6.1 The following provisions apply in relation to the issue of an **Interim Operational Notification**.
- CP.6.2 Not less than 28 days, or such shorter period as may be acceptable in **NGET's** reasonable opinion, prior to the **Generator** or **DC Converter Station** owner wishing to **Synchronise** its **Plant and Apparatus** or dynamically controlled **OTSUA** for the first time the **Generator** or **DC Converter Station** owner will:
- (i) submit to **NGET** a **Notification of User's Intention to Synchronise**; and
  - (ii) submit to **NGET** the items referred to at CP.6.3.
- CP.6.3 Items for submission prior to issue of the **Interim Operational Notification**.
- CP.6.3.1 Prior to the issue of an **Interim Operational Notification** in respect of the **GB Code User's Plant and Apparatus** or dynamically controlled **OTSUA**.
- the **Generator** or **DC Converter Station** owner must submit to **NGET** to **NGET's** satisfaction:
- (a) updated **Planning Code** data (both **Standard Planning Data** and **Detailed Planning Data**), with any estimated values assumed for planning purposes confirmed or, where practical, replaced by validated actual values and by updated estimates for the future and by updated forecasts for **Forecast Data** items such as **Demand**;
  - (b) details of any special **Power Station, Generating Unit(s), Power Park Module(s)** or **DC Converter Station(s)** protection as applicable. This may include Pole Slipping protection and islanding protection schemes;
  - (c) any items required by CP.5.2, updated by the **GB Code User** as necessary;
  - (d) simulation study provisions of Appendix CP.A.3 and the results demonstrating compliance with Grid Code requirements of:
    - PC.A.5.4.2
    - PC.A.5.4.3.2,

CC.6.3.4,  
CC.6.3.7(c)(i),  
CC.6.3.15,  
CC.A.6.2.5.6,  
CC.A.7.2.3.1,

as applicable to the **Power Station, Generating Unit(s), Power Park Module(s) or DC Converter(s)** or dynamically controlled **OTSUA** unless agreed otherwise by **NGET**;

- (e) a detailed schedule of the tests and the procedures for the tests required to be carried out by the **Generator or DC Converter Station** owner under CP.7.2 to demonstrate compliance with relevant Grid Code requirements. Such schedule to be consistent with Appendix OC5.A.2 (in the case of **Generating Units** other than **Power Park Modules**) or Appendix OC5.A.3 (in the case of **Generating Units** comprising **Power Park Modules**) and **OTSUA** as applicable); and
- (f) an interim **Compliance Statement** and a **User Self Certification of Compliance** completed by the **GB Code User** (including any **Unresolved Issues**) against the relevant Grid Code requirements including details of any requirements that the **Generator or DC Converter Station** owner has identified that will not or may not be met or demonstrated.

CP.6.3.2 The items referred to in CP.6.3 shall be submitted by the **Generator or DC Converter Station** owner using the **User Data File Structure**.

CP.6.4 No **Generating Unit, CCGT Module, Power Park Module or DC Converter** or dynamically controlled **OTSUA** shall be **Synchronised** to the **Total System** (and for the avoidance of doubt, dynamically controlled **OTSUA** will not be able to transmit), until the later of:

- (a) the date specified by **NGET** in the **Interim Operational Notification** issued in respect of the **Generating Unit(s), CCGT Module(s), Power Park Module(s) or DC Converter(s)** or dynamically controlled **OTSUA**; and,
- (b) if **Embedded**, the date of receipt of a confirmation from the **Network Operator** in whose **System** the **Plant and Apparatus** is connected that it is acceptable to the **Network Operator** that the **Plant and Apparatus** be connected and **Synchronised**; and,
- (c) in the case of **Synchronous Generating Unit(s)** only after the date of receipt by **Generator** of written confirmation from **NGET** that the **Generating Unit or CCGT Module** as applicable has completed the following tests to demonstrate compliance with the relevant provisions of the **Connection Conditions** to **NGET's** satisfaction:
  - (i) those tests required to establish the open and short circuit saturation characteristics of the **Generating Unit** (as detailed in Appendix OC5.A.2.3) to enable assessment of the short circuit ratio in accordance with CC.6.3.2. Such tests may be carried out at a location other than the **Power Station** site; and
  - (ii) open circuit step response tests (as detailed in Appendix OC5.A.2.2) to demonstrate compliance with CC.A.6.2.4.1.

CP.6.5 **NGET** shall assess the schedule of tests submitted by the **Generator or DC Converter Station** owner with the **Notification of User's Intention to Synchronise** under CP.6.1 and shall determine whether such schedule has been completed to **NGET's** satisfaction.

CP.6.6 When the requirements of CP.6.2 to CP.6.5 have been met, **NGET** will notify the **Generator or DC Converter Station** owner that the:

**Generating Unit,**  
**CCGT Module,**  
**Power Park Module,**

Dynamically controlled **OTSUA** or

**DC Converter**,

as applicable may (subject to the **Generator** or **DC Converter Station** owner having fulfilled the requirements of CP.6.3 where that applies) be **Synchronised** to the **Total System** through the issue of an **Interim Operational Notification**. Where the **Generator** is undertaking **OTSDUW** then the **Interim Operational Notification** will be in two parts, with the “**Interim Operational Notification Part A**” applicable to the **OTSUA** and the “**Interim Operational Notification Part B**” applicable to the **GB Code Users Plant and Apparatus**. For the avoidance of doubt, the **Interim Operational Notification Part A** and the **Interim Operational Notification Part B** can be issued together or at different times. In respect of an **Embedded Power Station** or **Embedded DC Converter Station** (other than a **Embedded Medium Power Stations** not subject to a **Bilateral Agreement** and **Embedded DC Converter Stations** not subject to a **Bilateral Agreement**), **NGET** will notify the **Network Operator** that an **Interim Operational Notification** has been issued.

CP.6.6.1 The **Interim Operational Notification** will be time limited, the expiration date being specified at the time of issue. The **Interim Operational Notification** may be renewed by **NGET**.

CP.6.6.2 The **Generator** or **DC Converter Station** owner must operate the **Generating Unit**, **CCGT Module**, **Power Park Module**, **OTSUA** or **DC Converter** in accordance with the terms, arising from the **Unresolved Issues**, of the **Interim Operational Notification**. Where practicable, **NGET** will discuss such terms with the **Generator** or **DC Converter Station** owner prior to including them in the **Interim Operational Notification**.

CP.6.6.3 The **Interim Operational Notification** will include the following limitations:

- (a) In the case of **OTSUA**, the **Interim Operational Notification Part A** permits **Synchronisation** of the dynamically controlled **OTSUA** to the **Total System** only for the purposes of active control of voltage and reactive power and not for the purpose of exporting **Active Power**.
- (b) In the case of a **Power Park Module** the **Interim Operational Notification** (and where **OTSDUW Arrangements** apply, this reference will be to the **Interim Operational Notification Part B**) will limit the proportion of the **Power Park Module** which can be simultaneously **Synchronised** to the **Total System** such that neither of the following figures is exceeded:
  - (i) 20% of the **Registered Capacity** of the **Power Park Module** (or the output of a single **Power Park Unit** where this exceeds 20% of the **Power Station's Registered Capacity**); nor
  - (ii) 50MW

until the **Generator** has completed the voltage control tests (detailed in OC5.A.3.2) (including in respect of any dynamically controlled **OTSUA**) to **NGET's** reasonable satisfaction. Following successful completion of this test each additional **Power Park Unit** should be included in the voltage control scheme as soon as is technically possible (unless **NGET** agrees otherwise).

- (b) In the case of a **Power Park Module** with a **Registered Capacity** greater or equal to 100MW, the **Interim Operational Notification** (and where **OTSDUW Arrangements** apply, this reference will be to the **Interim Operational Notification Part B**) will limit the proportion of the **Power Park Module** which can be simultaneously **Synchronised** to the **Total System** to 70% of **Registered Capacity** until the **Generator** has completed the **Limited Frequency Sensitive Mode** control tests with at least 50% of the **Registered Capacity** of the **Power Park Module** in service (detailed in OC5.A.3.3) to **NGET's** reasonable satisfaction.

- (c) In the case of a **Synchronous Generating Unit** employing a static **Excitation System** the **Interim Operational Notification** (and where **OTSDUW Arrangements** apply, this reference will be to the **Interim Operational Notification Part B**) may if applicable limit the maximum **Active Power** output and reactive power output of the **Synchronous Generating Unit** or **CCGT module** prior to the successful commissioning of the **Power System Stabiliser** to **NGET's** satisfaction.

CP.6.6.4 When a **GB Code User** and **NGET** are acting/operating in accordance with the provisions of a **Interim Operational Notification**, whilst it is in force, the relevant provisions of the Grid Code to which that **Interim Operational Notification** relates will not apply to the **GB Code User** or **NGET** to the extent and for the period set out in the **Interim Operational Notification**.

CP.6.7 Other than **Unresolved Issues** that are subject to tests required under CP.7.2 to be witnessed by **NGET**, the **Generator** or **DC Converter Station** owner must resolve any **Unresolved Issues** prior to the commencement of the tests, unless **NGET** agrees to a later resolution. The **Generator** or **DC Converter Station** owner must liaise with **NGET** in respect of such resolution. The tests that may be witnessed by **NGET** are specified in CP.7.2.

CP.6.8 Not less than 28 days, or such shorter period as may be acceptable in **NGET's** reasonable opinion, prior to the **Generator** or **DC Converter Station** owner wishing to commence tests required under CP.7 to be witnessed by **NGET**, the **Generator** or **DC Converter Station** owner will notify **NGET** that the **Generating Unit(s)**, **CCGT Module(s)**, **Power Park Module(s)** or **DC Converter(s)** as applicable is ready to commence such tests.

CP.6.9 The items referred to at CP.7.3 shall be submitted by the **Generator** or the **DC Converter Station** owner after successful completion of the tests required under CP.7.2.

## CP.7. FINAL OPERATIONAL NOTIFICATION

CP.7.1 The following provisions apply in relation to the issue of a **Final Operational Notification**.

CP.7.2 Tests to be carried out prior to issue of the **Final Operational Notification**

CP.7.2.1 Prior to the issue of a **Final Operational Notification** the **Generator** or **DC Converter Station** owner must have completed the tests specified in this CP.7.2.2 to **NGET's** satisfaction to demonstrate compliance with the relevant Grid Code provisions.

CP.7.2.2 In the case of any **Generating Unit**, **CCGT Module**, **Power Park Module**, **OTSUA** (if applicable) and **DC Converter** these tests will comprise one or more of the following:

- (a) reactive capability tests to demonstrate that the **Generating Unit**, **CCGT Module**, **Power Park Module**, **OTSUA** (if applicable) and **DC Converter** can meet the requirements of CC.6.3.2. These may be witnessed by **NGET** on site if there is no metering to the **NGET Control Centre**.
- (b) voltage control system tests to demonstrate that the **Generating Unit**, **CCGT Module**, **Power Park Module**, **OTSUA** (if applicable) and **DC Converter** can meet the requirements of CC.6.3.6, CC.6.3.8 and, in the case of **Power Park Module**, **OTSUA** (if applicable) and **DC Converter**, the requirements of CC.A.7 and, in the case of **Generating Unit** and **CCGT Module**, the requirements of CC.A.6, and any terms specified in the **Bilateral Agreement** as applicable. These tests may also be used to validate the **Excitation System** model (PC.A.5.3) or voltage control system model (PC.A.5.4) as applicable. These tests may be witnessed by **NGET**.
- (c) governor or frequency control system tests to demonstrate that the **Generating Unit**, **CCGT Module**, **OTSUA** (if applicable) and **Power Park Module** can meet the requirements of CC.6.3.6, CC.6.3.7, where applicable CC.A.3, and BC.3.7. The results will also validate the **Mandatory Service Agreement** required by CC.8.1. These tests may also be used to validate the Governor model (PC.A.5.3) or frequency control system model (PC.A.5.4) as applicable. These tests may be witnessed by **NGET**.

- (d) fault ride through tests in respect of a **Power Station** with a **Registered Capacity** of 100MW or greater, comprised of one or more **Power Park Modules**, to demonstrate compliance with CC.6.3.15 (a), (b) and (c), CC.A.4.1, CC.A.4.2 and CC.A.4.3. Where test results from a **Manufacturers Data & Performance Report** as defined in CP.10 have been accepted this test will not be required.
- (e) any further tests reasonably required by **NGET** and agreed with the **GB Code User** to demonstrate any aspects of compliance with the Grid Code and the **CUSC Contracts**.

CP.7.2.3 **NGET's** preferred range of tests to demonstrate compliance with the **CC** are specified in Appendix OC5.A.2 (in the case of **Generating Units** other than **Power Park Modules**) or Appendix OC5.A.3 (in the case of **Generating Units** comprising **Power Park Modules** or **OTSUA** if applicable) or Appendix OC5.A.4 (in the case of **DC Converters**) and are to be carried out by the **GB Code User** with the results of each test provided to **NGET**. The **GB Code User** may carry out an alternative range of tests if this is agreed with **NGET**. **NGET** may agree a reduced set of tests where there is a relevant **Manufacturers Data & Performance Report** as detailed in CP.10.

CP.7.2.4 In the case of **Offshore Power Park Modules** which do not contribute to **Offshore Transmission Licensee Reactive Power** capability as described in CC.6.3.2(e)(i) or CC.6.3.2(e)(ii) or Voltage Control as described in CC.6.3.8(b)(i) the tests outlined in CP.7.2.2 (a) and CP.7.2.2 (b) are not required. However, the offshore reactive power transfer tests outlined in OC5.A.2.8 shall be completed in their place.

CP.7.2.5 Following completion of each of the tests specified in this CP.7.2, **NGET** will notify the **Generator** or **DC Converter Station** owner whether, in the opinion of **NGET**, the results demonstrate compliance with the relevant Grid Code conditions.

CP.7.2.6 The **Generator** or **DC Converter Station** owner is responsible for carrying out the tests and retains the responsibility for safety and personnel during the test.

CP.7.3 Items for submission prior to issue of the **Final Operational Notification**

CP.7.3.1 Prior to the issue of a **Final Operational Notification** the **Generator** or **DC Converter Station** owner must submit to **NGET** to **NGET's** satisfaction:

- (a) updated **Planning Code** data (both **Standard Planning Data** and **Detailed Planning Data**), with validated actual values and updated estimates for the future including **Forecast Data** items such as **Demand**;
- (b) any items required by CP.5.2 and CP.6.3, updated by the **GB Code User** as necessary;
- (c) evidence to **NGET's** satisfaction that demonstrates that the controller models and/or parameters (as required under PC.A.5.3.2(c) option 2, PC.A.5.3.2(d) option 2, PC.A.5.4.2, and/or PC.A.5.4.3.2) supplied to **NGET** provide a reasonable representation of the behaviour of the **GB Code User's Plant** and **Apparatus** and **OTSUA** if applicable;
- (d) results from the tests required in accordance with CP.7.2 carried out by the **Generator** to demonstrate compliance with relevant Grid Code requirements including the tests witnessed by **NGET**; and
- (e) the final **Compliance Statement** and a **User Self Certification of Compliance** signed by the **GB Code User** and a statement of any requirements that the **Generator** or **DC Converter Station** owner has identified that have not been met together with a copy of the derogation in respect of the same from the **Authority**.

CP.7.3.2 The items in CP.7.3 should be submitted by the **Generator** (including in respect of any **OTSUA** if applicable) or **DC Converter Station** owner using the **User Data File Structure**.



CP.7.4 If the requirements of CP.7.2 and CP.7.3 have been successfully met, **NGET** will notify the **Generator** or **DC Converter Station** owner that compliance with the relevant Grid Code provisions has been demonstrated for the **Generating Unit(s)**, **CCGT Module(s)**, **Power Park Module(s)**, **OTSUA**, if applicable or **DC Converter(s)** as applicable through the issue of a **Final Operational Notification**. In respect of a **Embedded Power Station** or **Embedded DC Converter Station** other than a **Embedded Medium Power Stations** not subject to a **Bilateral Agreement** and **Embedded DC Converter Stations** not subject to a **Bilateral Agreement**, **NGET** will notify the **Network Operator** that a **Final Operational Notification** has been issued.

CP.7.5 If a **Final Operational Notification** can not be issued because the requirements of CP.7.2 and CP.7.3 have not been successfully met prior to the expiry of an **Interim Operational Notification** then the **Generator** or **DC Converter Station** owner (where licensed in respect of its activities) and/or **NGET** shall apply to the **Authority** for a derogation. The provisions of CP.9 shall then apply.

## CP.8 LIMITED OPERATIONAL NOTIFICATION

CP.8.1 Following the issue of a **Final Operational Notification** if:

- (i) the **Generator** or **DC Converter Station** owner becomes aware, that its **Plant** and/or **Apparatus**' (including **OTSUA** if applicable) capability to meet any provisions of the Grid Code, or where applicable the **Bilateral Agreement** is not fully available then the **Generator** or **DC Converter Station** owner shall follow the process in CP.8.2 to CP.8.11; or,
- (ii) a **Network Operator** becomes aware, that the capability of **Plant** and/or **Apparatus**' belonging to a **Embedded Power Station** or **Embedded DC Converter Station** (other than a **Embedded Medium Power Stations** not subject to a **Bilateral Agreement** and **Embedded DC Converter Stations** not subject to a **Bilateral Agreement**) is failing to meet any provisions of the Grid Code, or where applicable the **Bilateral Agreement** then the **Network Operator** shall inform **NGET** and **NGET** shall inform the **Generator** or **DC Converter Station** owner and then follow the process in CP.8.2 to CP.8.11; or,
- (iii) **NGET** becomes aware through monitoring as described in OC5.4, that a **Generator** or **DC Converter Station** owner **Plant** and/or **Apparatus**' (including **OTSUA** if applicable) capability to meet any provisions of the Grid Code, or where applicable the **Bilateral Agreement** is not fully available then **NGET** shall inform the other party. Where **NGET** and the **Generator** or **DC Converter Station** owner cannot agree from the monitoring as described in OC5.4 whether the **Plant and/or Apparatus** (including **OTSUA** if applicable) is fully available and/or is compliant with the requirements of the Grid Code and where applicable the **Bilateral Agreement**, the parties shall first apply the process in OC5.5.1, before applying the process defined in CP.8 (**LON**) if applicable. Where the testing instructed in accordance with OC.5.5.1 indicates that the **Plant** and/or **Apparatus** (including **OTSUA** if applicable) is not fully available and/or is not compliant with the requirements of the Grid Code and/or the **Bilateral Agreement**, or if the parties so agree, the process in CP.8.2 to CP.8.11 shall be followed.

CP.8.2 Immediately upon a **Generator** or **DC Converter Station** owner becoming aware that its **Generating Unit**, **CCGT Module**, **Power Park Module**, **OTSUA** (if applicable) or **DC Converter Station** as applicable may be unable to comply with certain provisions of the Grid Code or (where applicable) the **Bilateral Agreement**, the **Generator** or **DC Converter Station** owner shall notify **NGET** in writing. Additional details of any operating restrictions or changes in applicable data arising from the potential non-compliance and an indication of the date from when the restrictions will be removed and full compliance demonstrated shall be provided as soon as reasonably practical.

- CP.8.3 If the nature of any unavailability and/or potential non-compliance described in CP.8.1 causes or can reasonably be expected to cause a material adverse effect on the business or condition of **NGET** or other **Users** or the **National Electricity Transmission System** or any **User Systems** then **NGET** may, notwithstanding the provisions of this CP.8 follow the provisions of Paragraph 5.4 of the **CUSC**.
- CP.8.4 Except where the provisions of CP.8.3 apply, where the restriction notified in CP.8.2 is not resolved in 28 days then the **Generator** or **DC Converter Station** owner with input from and discussion of conclusions with **NGET**, and the **Network Operator** where the **Generating Unit, CCGT Module, Power Park Module** or **Power Station** as applicable is **Embedded**, shall undertake an investigation to attempt to determine the causes of and solution to the non-compliance. Such investigation shall continue for no longer than 56 days. During such investigation the **Generator** or **DC Converter Station** owner shall provide to **NGET** the relevant data which has changed due to the restriction in respect of CP.7.3.1 as notified to the **Generator** or **DC Converter Station** owner by **NGET** as being required to be provided.
- CP.8.5 Issue and Effect of LON
- CP.8.5.1 Following the issue of a **Final Operational Notification**, **NGET** will issue to the **Generator** or **DC Converter Station** owner a **Limited Operational Notification** if:
- (a) by the end of the 56 day period referred to at CP.8.4, the investigation has not resolved the non-compliance to **NGET's** satisfaction; or
  - (b) **NGET** is notified by a **Generator** or **DC Converter Station** owner of a **Modification** to its **Plant** and **Apparatus** (including **OTSUA** if applicable); or
  - (c) **NGET** receives a submission of data, or a statement from a **Generator** or **DC Converter Station** owner indicating a change in **Plant** or **Apparatus** (including **OTSUA** if applicable) or settings (including but not limited to governor and excitation control systems) that may in **NGET's** reasonable opinion, acting in accordance with **Good Industry Practice** be expected to result in a material change of performance.
- In the case of an **Embedded Generator** or **Embedded DC Converter Station** owner, **NGET** will issue a copy of the **Limited Operational Notification** to the **Network Operator**.
- CP.8.5.2 The **Limited Operational Notification** will be time limited to expire no later than 12 months from the start of the non-compliance or restriction or from reconnection following a change. **NGET** may agree a longer duration in the case of a **Limited Operational Notification** following a **Modification** or whilst the **Authority** is considering the application for a derogation in accordance with CP.9.1.
- CP.8.5.3 The **Limited Operational Notification** will notify the **Generator** or **DC Converter Station** owner of any restrictions on the operation of the **Generating Unit(s), CCGT Module(s), Power Park Module(s), OTSUA** (if applicable) or **DC Converter(s)** and will specify the **Unresolved Issues**. The **Generator** or **DC Converter Station** owner must operate in accordance with any notified restrictions and must resolve the **Unresolved Issues**.
- CP.8.5.4 When a **GB Code User** and **NGET** are acting/operating in accordance with the provisions of a **Limited Operational Notification**, whilst it is in force, the relevant provisions of the Grid Code to which that **Limited Operational Notification** relates will not apply to the **GB Code User** or **NGET** to the extent and for the period set out in the **Limited Operational Notification**.
- CP.8.5.5 The **Unresolved Issues** included in a **Limited Operational Notification** will show the extent that the provisions of CP.7.2 (testing) and CP.7.3 (final data submission) shall apply. In respect of selecting the extent of any tests which may in **NGET's** view reasonably be needed to demonstrate the restored capability and in agreeing the time period in which the tests will be scheduled, **NGET** shall, where reasonably practicable, take account of the **Generator** or **DC Converter Station** owner's input to contain its costs associated with the testing.

- CP.8.5.6 In the case of a change or **Modification** the **Limited Operational Notification** may specify that the affected **Plant** and/or **Apparatus** (including **OTSUA** if applicable) or associated **Generating Unit(s)** or **Power Park Unit(s)** must not be **Synchronised** until all of the following items, that in **NGET's** reasonable opinion are relevant, have been submitted to **NGET** to **NGET's** satisfaction:
- (a) updated **Planning Code** data (both **Standard Planning Data** and **Detailed Planning Data**);
  - (b) details of any relevant special **Power Station, Generating Unit(s), Power Park Module(s), OTSUA (if applicable)** or **DC Converter Station(s)** protection as applicable. This may include **Pole Slipping** protection and islanding protection schemes; and
  - (c) simulation study provisions of Appendix CP.A.3 and the results demonstrating compliance with Grid Code requirements relevant to the change or **Modification** as agreed by **NGET**; and
  - (d) a detailed schedule of the tests and the procedures for the tests required to be carried out by the **Generator** or **DC Converter Station** to demonstrate compliance with relevant Grid Code requirements as agreed by **NGET**. The schedule of tests shall be consistent with Appendix OC5.A.2 or Appendix OC5.A.3 as appropriate; and
  - (e) an interim **Compliance Statement** and a **User Self Certification of Compliance** completed by the **GB Code User** (including any **Unresolved Issues**) against the relevant Grid Code requirements including details of any requirements that the **Generator** or **DC Converter Station** owner has identified that will not or may not be met or demonstrated; and
  - (f) any other items specified in the **LON**.
- CP.8.5.7 The items referred to in CP.8.5.6 shall be submitted by the **Generator** (including in respect of any **OTSUA** if applicable) or **DC Converter Station** owner using the **User Data File Structure**.
- CP.8.5.8 In the case of **Synchronous Generating Unit(s)** only, the **Unresolved Issues** of the **LON** may require that the **Generator** must complete the following tests to **NGET's** satisfaction to demonstrate compliance with the relevant provisions of the **CCs** prior to the **Generating Unit** being **Synchronised** to the **Total System**:
- (a) those tests required to establish the open and short circuit saturation characteristics of the **Generating Unit** (as detailed in Appendix OC5.A.2.3) to enable assessment of the short circuit ratio in accordance with CC.6.3.2. Such tests may be carried out at a location other than the **Power Station** site; and
  - (b) open circuit step response tests (as detailed in Appendix OC5.A.2.2) to demonstrate compliance with CC.A.6.2.4.1.
- CP.8.6 In the case of a change or **Modification**, not less than 28 days, or such shorter period as may be acceptable in **NGET's** reasonable opinion, prior to the **Generator** or **DC Converter Station** owner wishing to **Synchronise** its **Plant** and **Apparatus** (including **OTSUA** if applicable) for the first time following the change or **Modification**, the **Generator** or **DC Converter Station** owner will:
- (i) submit a **Notification of User's Intention to Synchronise**; and
  - (ii) submit to **NGET** the items referred to at CP.8.5.6.
- CP.8.7 Other than **Unresolved Issues** that are subject to tests to be witnessed by **NGET**, the **Generator** or **DC Converter Station** owner must resolve any **Unresolved Issues** prior to the commencement of the tests, unless **NGET** agrees to a later resolution. The **Generator** or **DC Converter Station** owner must liaise with **NGET** in respect of such resolution. The tests that may be witnessed by **NGET** are specified in CP.7.2.2.

- CP.8.8 Not less than 28 days, or such shorter period as may be acceptable in **NGET's** reasonable opinion, prior to the **Generator** or **DC Converter Station** owner wishing to commence tests listed as **Unresolved Issues** to be witnessed by **NGET**, the **Generator** or **DC Converter Station** owner will notify **NGET** that the **Generating Unit(s)**, **CCGT Module(s)**, **Power Park Module(s)**, **OTSUA** (if applicable) or **DC Converter(s)** as applicable is ready to commence such tests.
- CP.8.9 The items referred to at CP.7.3 and listed as **Unresolved Issues** shall be submitted by the **Generator** or the **DC Converter Station** owner after successful completion of the tests.
- CP.8.10 Where the **Unresolved Issues** have been resolved a **Final Operational Notification** will be issued to the **GB Code User**.
- CP.8.11 If a **Final Operational Notification** has not been issued by **NGET** within the 12 month period referred to at CP.8.5.2 (or where agreed following a **Modification** by the expiry time of the **LON**) then the **Generator** or **DC Converter Station** owner (where licensed in respect of its activities) and **NGET** shall apply to the **Authority** for a derogation.
- CP.9 PROCESSES RELATING TO DEROGATIONS
- CP.9.1 Whilst the **Authority** is considering the application for a derogation, the **Interim Operational Notification** or **Limited Operational Notification** will be extended to remain in force until the **Authority** has notified **NGET** and the **Generator** or **DC Converter Station** owner of its decision. Where the **Generator** or **DC Converter Station** owner is not licensed **NGET** may propose any necessary changes to the **Bilateral Agreement** with such unlicensed **Generator** or **DC Converter Station** owner.
- CP.9.2 If the **Authority**:
- (a) grants a derogation in respect of the **Plant** and/or **Apparatus**, then **NGET** shall issue **Final Operational Notification** once all other **Unresolved Issues** are resolved; or
  - (b) decides a derogation is not required in respect of the **Plant** and/or **Apparatus** then **NGET** will reconsider the relevant **Unresolved Issues** and may issue a **Final Operational Notification** once all other **Unresolved Issues** are resolved; or
  - (c) decides not to grant any derogation in respect of the **Plant** and/or **Apparatus**, then there will be no **Operational Notification** in place and **NGET** and the **GB Code User** shall consider its rights pursuant to the **CUSC**.
- CP.9.3 Where an **Interim Operational Notification** or **Limited Operational Notification** is so conditional upon a derogation and such derogation includes any conditions (including any time limit to such derogation) the **Generator** or **DC Converter Station** owner will progress the resolution of any **Unresolved Issues** and / or progress and / or comply with any conditions upon such derogation and the provisions of CP.6.9 to CP.7.4 shall apply and shall be followed.
- CP.10 MANUFACTURER'S DATA & PERFORMANCE REPORT
- CP.10.1.1 Data and performance characteristics in respect of certain Grid Code requirements may be registered with **NGET** by **Power Park Unit** manufacturers in respect of specific models of **Power Park Units** by submitting information in the form of a **Manufacturer's Data and Performance Report** to **NGET**.

- CP.10.1.2 A **GB Generator** planning to construct a **Power Station** containing the appropriate version of **Power Park Units** in respect of which a **Manufacturer's Data & Performance Report** has been submitted to **NGET** may reference the **Manufacturer's Data & Performance Report** in its submissions to **NGET**. Any **Generator** considering referring to a **Manufacturer's Data & Performance Report** for any aspect of its **Plant** and **Apparatus** may contact **NGET** to discuss the suitability of the relevant **Manufacturer's Data & Performance Report** to its project to determine if, and to what extent, the data included in the **Manufacturer's Data & Performance Report** contributes towards demonstrating compliance with those aspects of the Grid Code applicable to the **Generator**. **NGET** will inform the **Generator** if the reference to the **Manufacturer's Data & Performance Report** is not appropriate or not sufficient for its project.
- CP.10.1.3 The process to be followed by **Power Park Unit** manufacturers submitting a **Manufacturer's Data & Performance Report** is agreed by **NGET**. CP.10.2 indicates the specific Grid Code requirement areas in respect of which a **Manufacturer's Data & Performance Report** may be submitted.
- CP.10.1.4 **NGET** will maintain and publish a register of those **Manufacturer's Data & Performance Reports** which **NGET** has received and accepted as being an accurate representation of the performance of the relevant **Plant** and / or **Apparatus**. Such register will identify the manufacturer, the model(s) of **Power Park Unit(s)** to which the report applies and the provisions of the Grid Code in respect of which the report contributes towards the demonstration of compliance. The inclusion of any report in the register does not in any way confirm that any **Power Park Modules** which utilise any **Power Park Unit(s)** covered by a report is or will be compliant with the Grid Code.
- CP.10.2 A **Manufacturer's Data & Performance Report** in respect of **Power Park Units** may cover one (or part of one) or more of the following provisions of the Grid Code:
- (a) Fault Ride Through capability CC.6.3.15
  - (b) **Power Park Module** mathematical model PC.A.5.4.2
- CP.10.3 Reference to a **Manufacturer's Data & Performance Report** in a **GB Code User's** submissions does not by itself constitute compliance with the Grid Code.
- CP.10.4 A **Generator** referencing a **Manufacturer's Data & Performance Report** should insert the relevant **Manufacturer's Data & Performance Report** reference in the appropriate place in the **DRC** data submission and / or in the **User Data File Structure**. **NGET** will consider the suitability of a **Manufacturer's Data & Performance Report**:
- (a) in place of **DRC** data submissions a mathematical model suitable for representation of the entire **Power Park Module** as per CP.A.3.4.4. For the avoidance of doubt only the relevant sections as specified in PC.A.2.5.5.7 apply. Site specific parameters will still need to be submitted by the **Generator**.
  - (b) in place of Fault simulation studies as follows;  
**NGET** will not require Fault Ride Through simulation studies to be conducted as per CP.A.3.5.1 and qualified in CP.A.3.5.2 provided that;
    - (i) Adequate and relevant **Power Park Unit** data is included in respect of Fault Ride Through testing covered in CP.A.14.7.1 in the relevant **Manufacturer's Data & Performance Report** , and
    - (ii) For each type and duration of fault as detailed in CP.A.3.5.1, the expected minimum retained voltage is greater than the corresponding minimum voltage achieved and successfully ridden through in the fault ride through tests covered by the **Manufacturer's Data & Performance Report**.
  - (c) to reduce the scope of compliance site tests as follows;
    - (i) Where there is a **Manufacturer's Data & Performance Report** in respect of a **Power Park Unit** which covers Fault Ride Through, **NGET** may agree that no Fault Ride Through testing is required.

- CP.10.5 It is the responsibility of the **GB Code User** to ensure that the correct reference for the **Manufacturer's Data & Performance Report** is used and the **GB Code User** by using that reference accepts responsibility for the accuracy of the information. The **GB Code User** shall ensure that the manufacturer has kept **NGET** informed of any relevant variations in plant specification since the submission of the relevant **Manufacturer's Data & Performance Report** which could impact on the validity of the information.
- CP.10.6 **NGET** may contact the **Power Park Unit** manufacturer directly to verify the relevance of the use of such **Manufacturer's Data & Performance Report**. If **NGET** believe the use some or all of such **Manufacturer's Data & Performance Report** information is incorrect or the referenced data is inappropriate then the reference to the **Manufacturer's Data & Performance Report** may be declared invalid by **NGET**. Where, and to the extent possible, the data included in the **Manufacturer's Data & Performance Report** is appropriate, the compliance assessment process will be continued using the data included in the **Manufacturer's Data & Performance Report**.

# APPENDIX 1 - ILLUSTRATIVE PROCESS DIAGRAMS

## CP.A.1.1 Illustrative Compliance Process for Energisation of a User

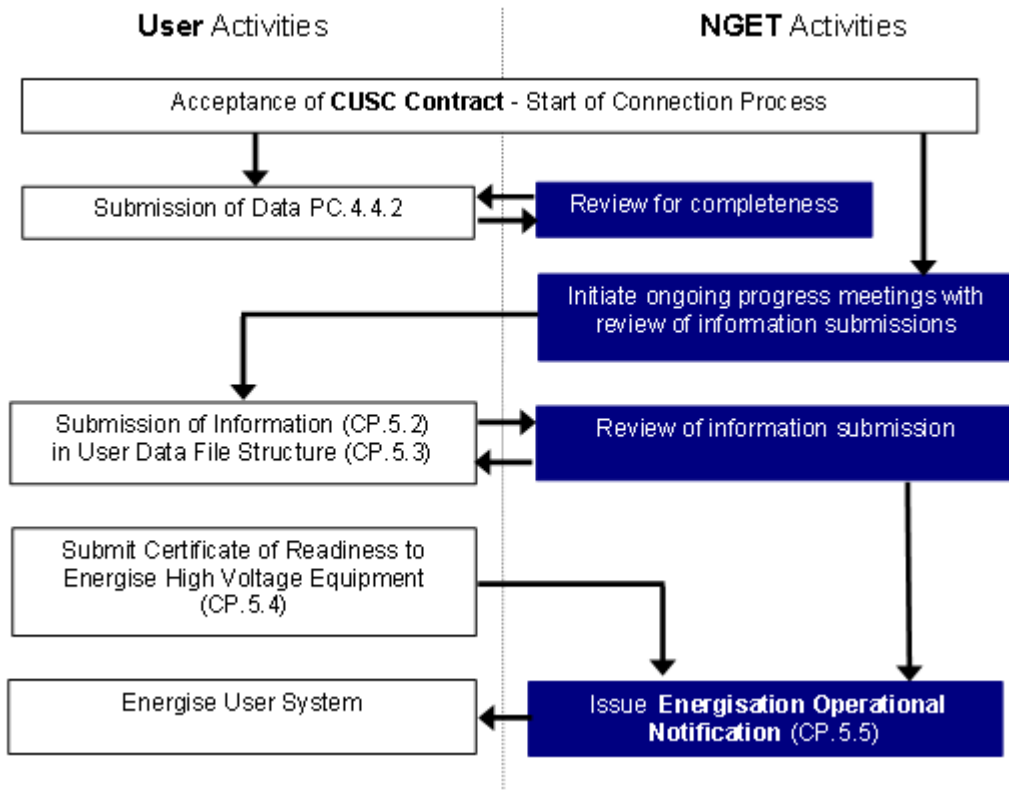

The process illustrated in CP.A.1.1 applies to all **GB Code Users** energising passive network **Plant** and **Apparatus** including **Distribution Network Operators, Non-embedded Customers, Generators** and **DC Converter Station** owners. This process is a subset of the full process for **Generators** and **DC Converter Station** owners shown in CP.A.1.2. This diagram illustrates the process in the **CP** and includes references in brackets to specific Grid Code clauses.

CP.A.1.2 Illustrative Compliance Process for Power Stations/DC Converter Stations

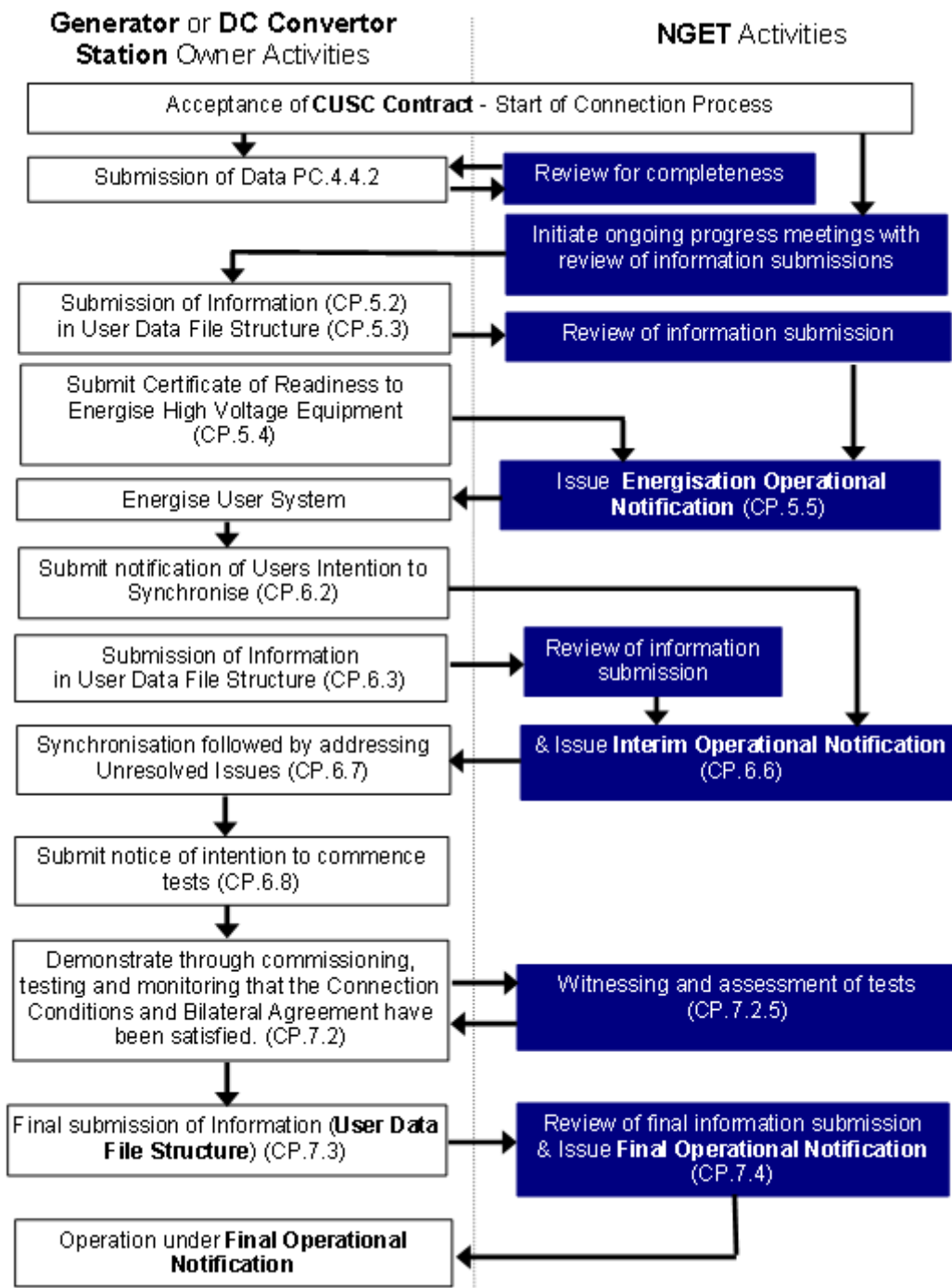

This diagram illustrates the process in the CP and includes references in brackets to specific Grid Code clauses. For the avoidance of doubt this process does not apply to **Embedded Medium Power Stations** not subject to a **Bilateral Agreement** and **Embedded DC Converter Stations** not subject to a **Bilateral Agreement**.



CP.A.1.3 Illustrative Compliance Process for Offshore Power Stations and OTSUA

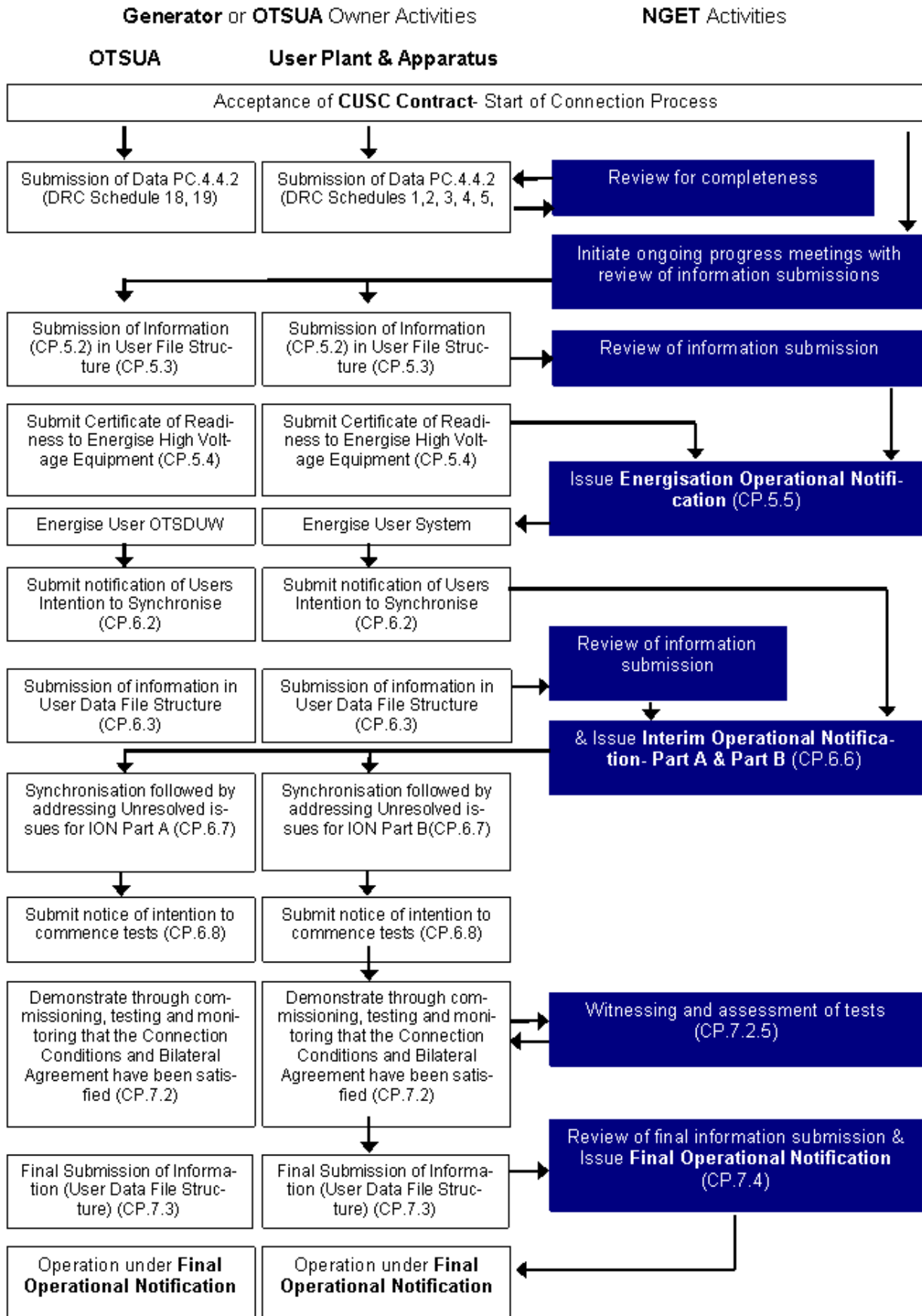

This diagram illustrates the process in the CP and includes references in brackets to specific Grid Code clauses.

CP.A.1.4 Illustrative Compliance Process for Ongoing Compliance

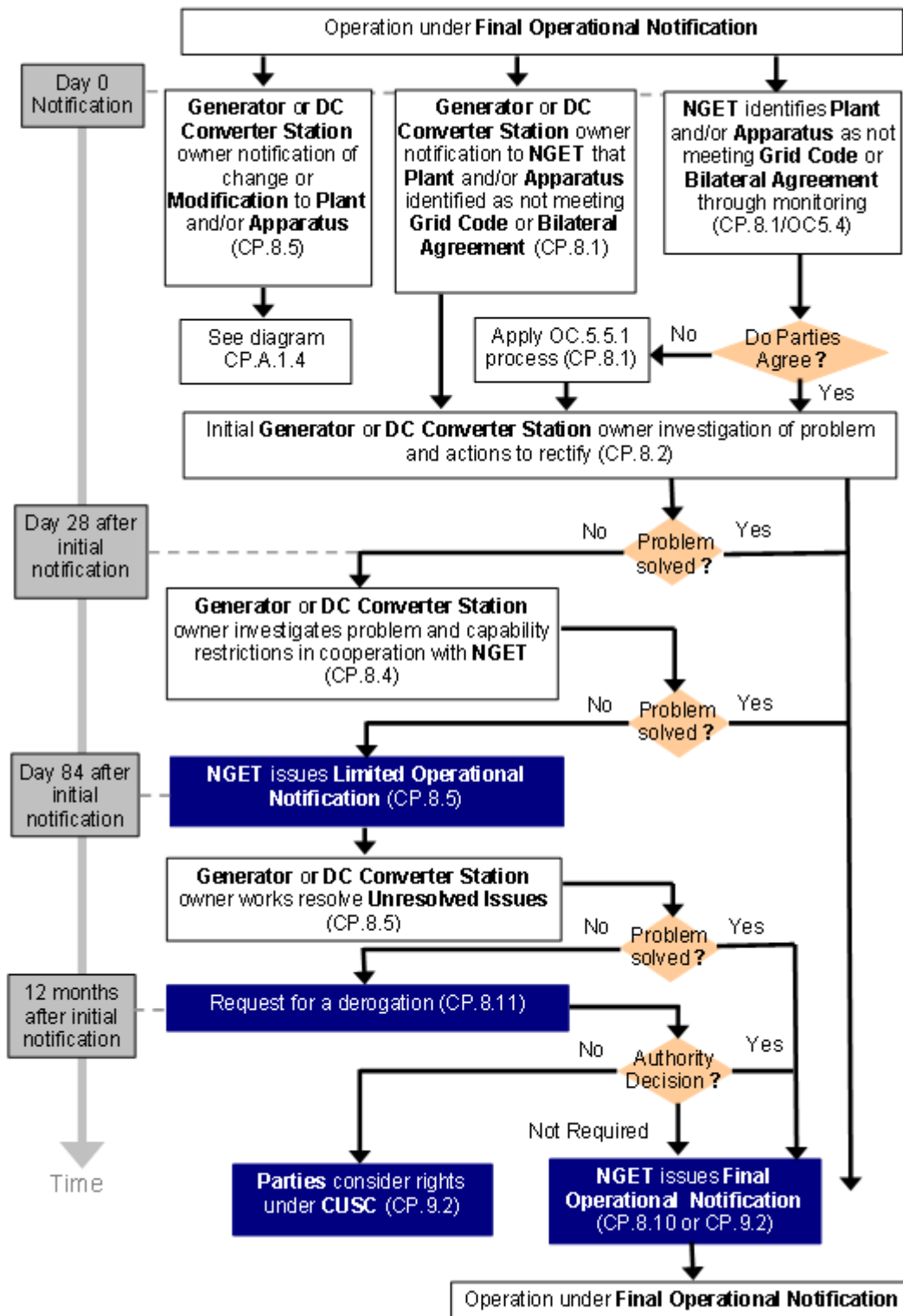

This diagram illustrates the process in the CP and includes references in brackets to specific Grid Code clauses. For the avoidance of doubt this process does not apply to **Embedded Medium Power Stations** not subject to a **Bilateral Agreement** and **Embedded DC Converter Stations** not subject to a **Bilateral Agreement**.

CP.A.1.5 Illustrative Compliance Process for Modification or change

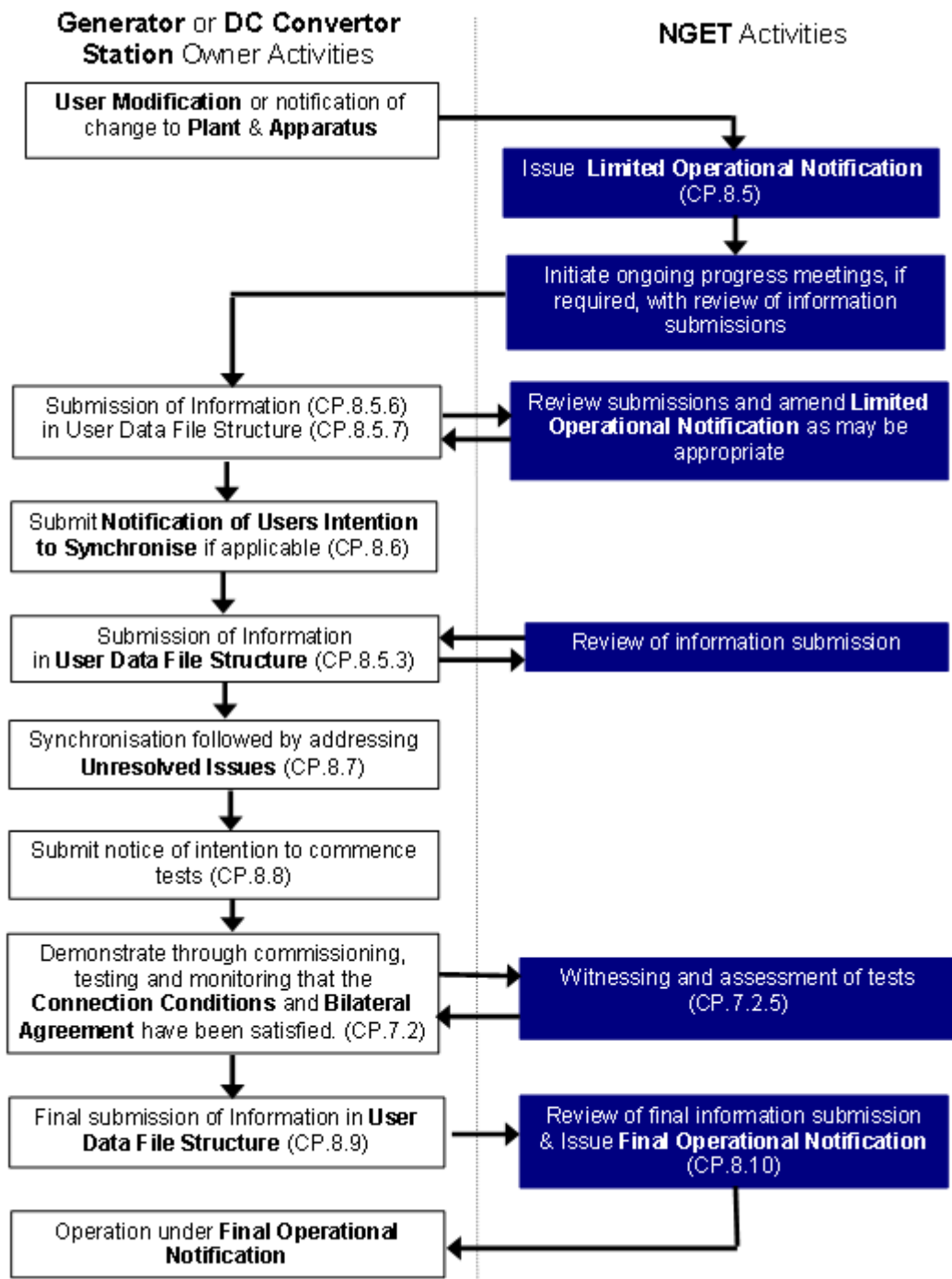

This diagram illustrates the process in the CP and includes references in brackets to specific Grid Code clauses. For the avoidance of doubt this process does not apply to **Embedded Medium Power Stations** not subject to a **Bilateral Agreement** and **Embedded DC Converter Stations** not subject to a **Bilateral Agreement**.

## APPENDIX 2 - USER SELF CERTIFICATION OF COMPLIANCE

### USER SELF CERTIFICATION OF COMPLIANCE (Interim/Final)

<b>Power Station/ DC Converter Station:</b>	[Name of Connection Site/site of connection]
<b>OTSUA</b>	[Name of Interface Site]
<b>GB Code User:</b>	[Full User name]
<b>Registered Capacity (MW) of Plant:</b>	

This **User Self Certification of Compliance** records the compliance by the **GB Code User** in respect of [NAME] **Power Station/DC Converter Station** [and, in the case of **OTSDUW Arrangements, OTSUA**] with the Grid Code and the requirements of the **Bilateral Agreement** and **Construction Agreement** dated [ ] with reference number [ ]. It is completed by the **Power Station/DC Converter Station** owner in the case of **Plant** and/or **Apparatus** (including **OTSUA**) connected to the **National Electricity Transmission System** and for **Embedded Plant**.

We have recorded our compliance against each requirement of the Grid Code which applies to the **Power Station/DC Converter Station/OTSUA**, together with references to supporting evidence and a commentary where this is appropriate, and have provided this to **NGET**. A copy of the **Compliance Statement** is attached.

Supporting evidence, in the form of simulation results, test results, manufacturer's data and other documentation, is attached in the **User Data File Structure**.

The **GB Code User** hereby certifies that, to the best of its knowledge and acting in accordance with **Good Industry Practice**, [the **Power Station** is compliant with the Grid Code and the **Bilateral Agreement**] [the **OTSUA** is compliant with the Grid Code and the **Construction Agreement**] in all aspects [with the following **Unresolved Issues\***] [with the following derogation(s)\*\*]:

Connection Condition	Requirement	Ref:	Issue

<b>Compliance certified by:</b>	Name: [PERSON] Signature: [PERSON] Date:	Title: [PERSON DESIGNATION] Of [GB CODE USER DETAILS]
---------------------------------	--	--

\* Include for Interim User Self Certification of Compliance ahead of Interim Operational Notification.

\*\* Include for final User Self Certification of Compliance ahead of Final Operational Notification where derogation(s) have been granted. If no derogation(s) required delete wording and Table.

## APPENDIX 3 - SIMULATION STUDIES

- CP.A.3.1.1 This Appendix sets out the simulation studies required to be submitted to **NGET** to demonstrate compliance with the Connection Conditions unless otherwise agreed with **NGET**. This Appendix should be read in conjunction with CP.6 with regard to the submission of the reports to **NGET**. Where there is any inconsistency in the technical requirements in respect of which compliance is being demonstrated by simulation in this Appendix and CC.6.3 and the **Bilateral Agreement**, the provisions of the **Bilateral Agreement** and CC.6.3 prevail. The studies specified in this Appendix will normally be sufficient to demonstrate compliance. However **NGET** may agree an alternative set of studies proposed by the **Generator** or **DC Converter Station** owner provided **NGET** deem the alternative set of studies sufficient to demonstrate compliance with the Grid Code and the **Bilateral Agreement**.
- CP.A.3.1.2 The **Generator** or **DC Converter Station** owner shall submit simulation studies in the form of a report to demonstrate compliance. In all cases the simulation studies must utilise models applicable to the **Generating Unit**, **DC Converter** or **Power Park Module** with proposed or actual parameter settings. Reports should be submitted in English with all diagrams and graphs plotted clearly with legible axes and scaling provided to ensure any variations in plotted values is clear.
- CP.A.3.1.3 In the case of an **Offshore Power Station** where **OTSDUW Arrangements** apply simulation studies by the **Generator** should include the action of any relevant **OTSUA** where applicable to demonstrate compliance with the Grid Code and the **Bilateral Agreement** at the **Interface Point**.
- CP.A.3.2 Power System Stabiliser Tuning
- CP.A.3.2.1 In the case of a **Synchronous Generating Unit** the **Power System Stabiliser** tuning simulation study report required by CC.A.6.2.5.6 or required by the **Bilateral Agreement** shall contain:
- (i) the **Excitation System** model including the **Power System Stabiliser** with settings as required under the **Planning Code** (PC.A.5.3.2(c))
  - (ii) on load time series dynamic simulation studies of the response of the **Excitation System** with and without the **Power System Stabiliser** to 2% and 10% steps in the reference voltage and a three phase short circuit fault applied to the higher voltage side of the **Generating Unit** transformer for 100ms. The simulation studies should be carried out with the **Generating Unit** operating at full **Active Power** and maximum leading **Reactive Power** import with the fault level at the **Supergrid HV** connection point at minimum or as otherwise agreed with **NGET**. The results should show **Generating Unit** field voltage, **Generating Unit** terminal voltage, **Power System Stabiliser** output, **Generating Unit Active Power** and **Generating Unit Reactive Power** output.
  - (iii) gain and phase Bode diagrams for the open loop frequency domain response of the **Generating Unit Excitation System** with and without the **Power System Stabiliser**. These should be in a suitable format to allow assessment of the phase contribution of the **Power System Stabiliser** and the gain and phase margin of the **Excitation System** with and without the **Power System Stabiliser** in service.
  - (iv) an eigenvalue plot to demonstrate that all modes remain stable when the **Power System Stabiliser** gain is increased by at least a factor of 3 from the designed operating value.
  - (v) gain Bode diagram for the closed loop on load frequency domain response of the **Generating Unit Excitation System** with and without the **Power System Stabiliser**. The **Generating Unit** operating at full load and at unity power factor. These diagrams should be in a suitable format to allow comparison of the **Active Power** damping across the frequency range specified in CC.A.6.2.6.3 with and without the **Power System Stabiliser** in service.

CP.A.3.2.2 In the case of **Onshore Non-Synchronous Generating Units, Onshore DC Converters and Onshore Power Park Modules and OTSDUW Plant and Apparatus** at the **Interface Point** the **Power System Stabiliser** tuning simulation study report required by CC.A.7.2.4.1 or required by the **Bilateral Agreement** shall contain:

- (i) the **Voltage Control System** model including the **Power System Stabiliser** with settings as required under the **Planning Code** (PC.A.5.4) and **Bilateral Agreement**.
- (ii) on load time series dynamic simulation studies of the response of the **Voltage Control System** with and without the **Power System Stabiliser** to 2% and 10% steps in the reference voltage and a three phase short circuit fault applied to the **Grid Entry Point** or the **Interface Point** in the case of **OTSDUW Plant and Apparatus** for 100ms. The simulation studies should be carried out operating at full **Active Power** and maximum leading **Reactive Power** import condition with the fault level at the **Supergrid HV** connection point at minimum or as otherwise agreed with **NGET**. The results should show appropriate signals to demonstrate the expected damping performance of the **Power System Stabiliser**.
- (iii) any other simulation as specified in the **Bilateral Agreement** or agreed between the **Generator** or **DC Converter Owner** or **Offshore Transmission Licensee** and **NGET**.

CP.A.3.3 Reactive Capability across the Voltage Range

CP.A.3.3.1 The **Generator** or **DC Converter station** owner shall supply simulation studies to demonstrate the capability to meet CC.6.3.4 by submission of a report containing:

- (i) a load flow simulation study result to demonstrate the maximum lagging **Reactive Power** capability of the **Synchronous Generating Unit, DC Converter, OTSUA or Power Park Module** at **Rated MW** when the **Grid Entry Point** or **User System Entry Point** if **Embedded** or **Interface Point** (in case of **OTSUA**) voltage is at 105% of nominal.
- (ii) a load flow simulation study result to demonstrate the maximum leading **Reactive Power** capability of the **Synchronous Generating Unit, DC Converter, OTSUA or Power Park Module** at **Rated MW** when the **Grid Entry Point** or **User System Entry Point** if **Embedded** or **Interface Point** (in case of **OTSUA**) voltage is at 95% of nominal.

CP.A.3.3.2 In the case of a **Synchronous Generating Unit** the terminal voltage in the simulation should be the nominal voltage for the machine. Where necessary to demonstrate compliance with CC.6.3.4 and subject to compliance with CC.6.3.8 (a) (v), the **Generator** shall repeat the two simulation studies with the terminal voltage being greater than the nominal voltage and less than or equal to the maximum terminal voltage. The two additional simulations do not need to have the same terminal voltage.

CP.A.3.3.3 In the case of a **Synchronous Generating Unit** the **Generator** shall supply two sets of simulation studies to demonstrate the capability to meet the operational requirements of BC2.A.2.6 and CC.6.1.7 at the minimum and maximum short circuit levels when changing tap position. Each set of simulation studies shall be at the same system conditions. None of the simulation studies shall include the **Synchronous Generating Unit** operating at the limits of its **Reactive Power** output.

The simulation results shall include the **Reactive Power** output of the **Synchronous Generating Unit** and the voltage at the **Grid Entry Point** or, if **Embedded**, the **User System Entry Point** with the **Generating Unit** transformer at two adjacent tap positions with the greatest interval between them and the terminal voltage of the **Synchronous Generating Unit** equal to

- its nominal value; and
- subject to compliance with CC.6.3.8 (a) (v), its maximum value.

- CP.A.3.3.4 In the case of a **Power Park Module** where the load flow simulation studies show that the individual **Power Park Units** deviate from nominal voltage to meet the **Reactive Power** requirements then evidence must be provided from factory (e.g. in a **Manufacturer's Data & Performance Report**) or site testing that the **Power Park Unit** is capable of operating continuously at the operating points determined in the load flow simulation studies.
- CP.A.3.4 Voltage Control and Reactive Power Stability
- CP.A.3.4.1 In the case of a power station containing **Power Park Modules** and/or **OTSUA** the **Generator** shall provide a report to demonstrate the dynamic capability and control stability of the **Power Park Module**. The report shall contain:
- (i) a dynamic time series simulation study result of a sufficiently large negative step in **System** voltage to cause a change in **Reactive Power** from zero to the maximum lagging value at **Rated MW**.
  - (ii) a dynamic time series simulation study result of a sufficiently large positive step in **System** voltage to cause a change in **Reactive Power** from zero to the maximum leading value at **Rated MW**.
  - (iii) a dynamic time series simulation study result to demonstrate control stability at the lagging **Reactive Power** limit by application of a -2% voltage step while operating within 5% of the lagging **Reactive Power** limit.
  - (iv) a dynamic time series simulation study result to demonstrate control stability at the leading **Reactive Power** limit by application of a +2% voltage step while operating within 5% of the leading **Reactive Power** limit.
- CP.A.3.4.2 All the above studies should be completed with a nominal network voltage for zero **Reactive Power** transfer at the **Grid Entry Point** or **User System Entry Point** if **Embedded** or, in the case of **OTSUA**, **Interface Point** unless stated otherwise and the fault level at the **HV** connection point at minimum as agreed with **NGET**.
- CP.A.3.4.3 **NGET** may permit relaxation from the requirements of CP.A.3.4.1(i) and (ii) for voltage control if the **Power Park Modules** are comprised of **Power Park Units** in respect of which the **GB Code User** has in its submissions to **NGET** referenced an appropriate **Manufacturer's Data & Performance Report** which is acceptable to **NGET** for voltage control.
- CP.A.3.4.4 In addition **NGET** may permit a further relaxation from the requirements of CP.A.3.4.1(iii) and (iv) if the **GB Code User** has in its submissions to **NGET** referenced an appropriate **Manufacturer's Data & Performance Report** for a **Power Park Module** mathematical model for voltage control acceptable to **NGET**.
- CP.A.3.5 Fault Ride Through
- CP.A.3.5.1 The **Generator**, (including where undertaking **OTSDUW**) or **DC Converter Station** owner shall supply time series simulation study results to demonstrate the capability of **Non-Synchronous Generating Units**, **DC Converters**, **Power Park Modules** and **OTSUA** to meet CC.6.3.15 by submission of a report containing:
- (i) a time series simulation study of a 140ms solid three phase short circuit fault applied on the nearest point of the **National Electricity Transmission System** operating at **Supergrid** voltage to the **Non-Synchronous Generating Unit**, **DC Converter**, **Power Park Module** or **OTSUA**.
  - (ii) time series simulation study of 140ms unbalanced short circuit faults applied on the nearest point of the **National Electricity Transmission System** operating at **Supergrid** voltage to the **Non-Synchronous Generating Unit**, **DC Converter**, **Power Park Module** or **OTSUA**. The unbalanced faults to be simulated are:
    1. a phase to phase fault
    2. a two phase to earth fault
    3. a single phase to earth fault.

For a **Non-Synchronous Generating Unit, DC Converter, Power Park Module** or **OTSUA** the simulation study should be completed with the **Non-Synchronous Generating Unit, DC Converter, Power Park Module** or **OTSUA** operating at full **Active Power** and maximum leading **Reactive Power** import and the fault level at the **Supergrid HV** connection point at minimum or as otherwise agreed with **NGET**.

(iii) time series simulation studies of balanced **Supergrid** voltage dips applied on the nearest point of the **National Electricity Transmission System** operating at **Supergrid** voltage to the **Non-Synchronous Generating Unit, DC Converter, Power Park Module** or **OTSUA**. The simulation studies should include:

1. 30% retained voltage lasting 0.384 seconds
2. 50% retained voltage lasting 0.71 seconds
3. 80% retained voltage lasting 2.5 seconds
4. 85% retained voltage lasting 180 seconds.

For a **Non-Synchronous Generating Unit, DC Converter, Power Park Module** or **OTSUA** the simulation study should be completed with the **Non-Synchronous Generating Unit, DC Converter, Power Park Module** or **OTSUA** operating at full **Active Power** and zero **Reactive Power** output and the fault level at the **Supergrid HV** connection point at minimum or as otherwise agreed with **NGET**. Where the **Non-Synchronous Generating Unit, DC Converter** or **Power Park Module** is **Embedded** the minimum **Network Operator's System** impedance to the **Supergrid HV** connection point shall be used which may be calculated from the maximum fault level at the **User System Entry Point**.

For **DC Converters** the simulations should include the duration of each voltage dip 1 to 4 above for which the **DC Converter** will remain connected.

CP.A.3.5.2 In the case of **Power Park Modules** comprised of **Power Park Units** in respect of which the **GB Code User's** reference to a **Manufacturer's Data & Performance Report** has been accepted by **NGET** for Fault Ride Through, CP.A.3.5.1 will not apply provided:

(i) the **Generator** or **DC Converter Station** owner demonstrates by load flow simulation study result that the faults and voltage dips at either side of the **Power Park Unit** transformer corresponding to the required faults and voltage dips in CP.A.3.5.1 applied at the nearest point of the **National Electricity Transmission System** operating at **Supergrid** voltage are less than those included in the **Manufacturer's Data & Performance Report**,

or;

(ii) the same or greater percentage faults and voltage dips in CP.A.3.5.1 have been applied at either side of the **Power Park Unit** transformer in the **Manufacturer's Data & Performance Report**.

CP.A.3.5.3 In the case of an **Offshore Power Park Module** or **Offshore DC Converter** the studies may instead be completed at the **LV Side of the Offshore Platform**. For fault simulation studies described in CCA.8.5.1(i) and CCA.8.5.1(ii) a retained voltage of 15% or lower may be applied at the **LV Side of the Offshore Platform** on the faulted phases. For voltage dip simulation studies described in CP.A.3.5.1(iii) the same voltage levels and durations as normally applied at the **National Electricity Transmission System** operating at **Supergrid Voltage** will be applied at the **LV Side of the Offshore Platform**.

CP.A.3.6 Load Rejection

CP.A.3.6.1 In respect of **Generating Units** or **DC Converters** or **Power Park Modules** with a **Completion Date** on or after 1 January 2012, the **Generator** or **DC Converter Station** owner shall demonstrate the speed control performance of the plant under a part load rejection condition as required by CC.6.3.7(c)(i), through simulation study. In respect of **Generating Units** or **DC Converters** or **Power Park Modules**, including those with a **Completion Date** before 1 January 2013, the load rejection capability while still supplying load must be stated in accordance with PC.A.5.3.2(f).



- CP.A.3.6.2 For **Power Park Modules** comprised of **Power Park Units** having a corresponding generically verified and validated model included in the **Manufacturer's Data & Performance Report** this study is not required if the correct **Manufacturer's Data & Performance Report** reference has been submitted in the appropriate location in the **Data Registration Code**.
- CP.A.3.6.3 The simulation study should comprise of a **Generating Unit, DC Converter or Power Park Module** connected to the total **System** with a local load shown as "X" in figure CP.A.3.6.1. The load "X" is in addition to any auxiliary load of the **Power Station** connected directly to the **Generating Unit, DC Converter or Power Park Module** and represents a small portion of the **System** to which the **Generating Unit, DC Converter or Power Park Module** is attached. The value of "X" should be the minimum for which the **Generating Unit, DC Converter or Power Park Module** can control the power island frequency to less than 52Hz. Where transient excursions above 52Hz occur the **Generator or DC Converter Owner** should ensure that the duration above 52Hz is less than any high frequency protection system applied to the **Generating Unit, DC Converter or Power Park Module**.
- CP.A.3.6.4 At the start of the simulation study the **Generating Unit, DC Converter or Power Park Module** will be operating maximum **Active Power** output. The **Generating Unit, DC Converter or Power Park Module** will then be islanded from the **Total System** but still supplying load "X" by the opening of a breaker, which is not the **Generating Unit, DC Converter or Power Park Module** connection circuit breaker (the governor should therefore, not receive any signals that the breaker has opened other than the reduction in load and subsequent increase in speed). A schematic arrangement of the simulation study is illustrated by Figure CP.A.3.6.1.

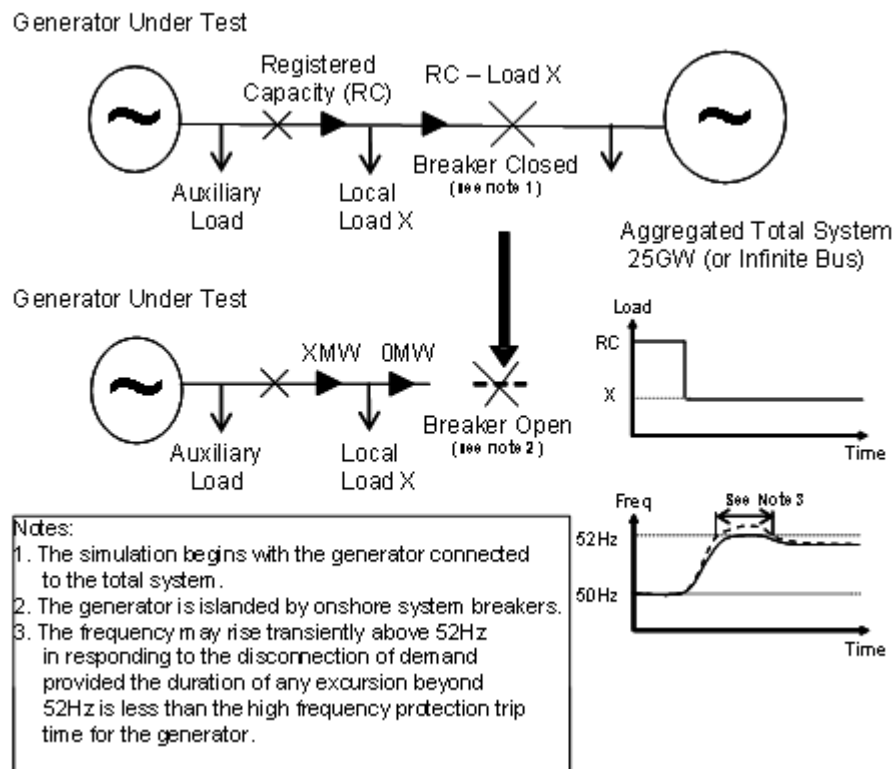

Figure CP.A.3.6.1 – Diagram of Load Rejection Study

- CP.A.3.6.5 Simulation study shall be performed for both control modes, **Frequency Sensitive Mode (FSM)** and **Limited Frequency Sensitive Mode (LFSM)**. The simulation study results should indicate **Active Power** and **Frequency** in the island system that includes the **Generating Unit, DC Converter or Power Park Module**.

CP.A.3.6.6 To allow validation of the model used to simulate load rejection in accordance with CC.6.3.7(c)(i) as described a further simulation study is required to represent the largest positive **Frequency** injection step or fast ramp (BC1 and BC3 of Figure 2) that will be applied as a test as described in OC5.A.2.8 and OC5.A.3.6.

CP.A.3.7 Voltage and Frequency Controller Model Verification and Validation

CP.A.3.7.1 For **Generating Units, DC Converters or Power Park Modules** with a **Completion Date** after 1 January 2012 or subject to a **Modification** to a **Excitation System**, voltage control system, governor control system or **Frequency** control system after 1 January 2012 the **Generator or DC Converter Station** owner shall provide simulation studies to verify that the proposed controller models supplied to **NGET** under the **Planning Code** are fit for purpose. These simulation study results shall be provided in the timescales stated in the **Planning Code**. For **Power Park Modules** comprised of **Power Park Units** having a corresponding generically verified and validated model in a **Manufacturer's Data & Performance Report** **NGET** may permit the simulation studies detailed in CP.A.3.7.2, CP.A.3.7.4 and CP.A.3.7.5 to be replaced by submission of the correct **Manufacturer's Data & Performance Report** reference in the appropriate location in the **Data Registration Code**.

CP.A.3.7.2 To demonstrate the **Frequency** control or governor/load controller/plant model the **Generator or DC Converter Station** owner shall submit a simulation study representing the response of the **Synchronous Generating Unit, DC Converter or Power Park Module** operating at 80% of **Registered Capacity**. The simulation study event shall be equivalent to:

- (i) a ramped reduction in the measured **System Frequency** of 0.5Hz in 10 seconds followed by
- (ii) 20 seconds of steady state with the measured **System Frequency** depressed by 0.5Hz followed by
- (iii) a ramped increase in measured **System Frequency** of 0.3Hz over 30 seconds followed by
- (iv) 60 seconds of steady state with the measured **System Frequency** depressed by 0.2Hz as illustrated in Figure CP.A.3.7.2 below.

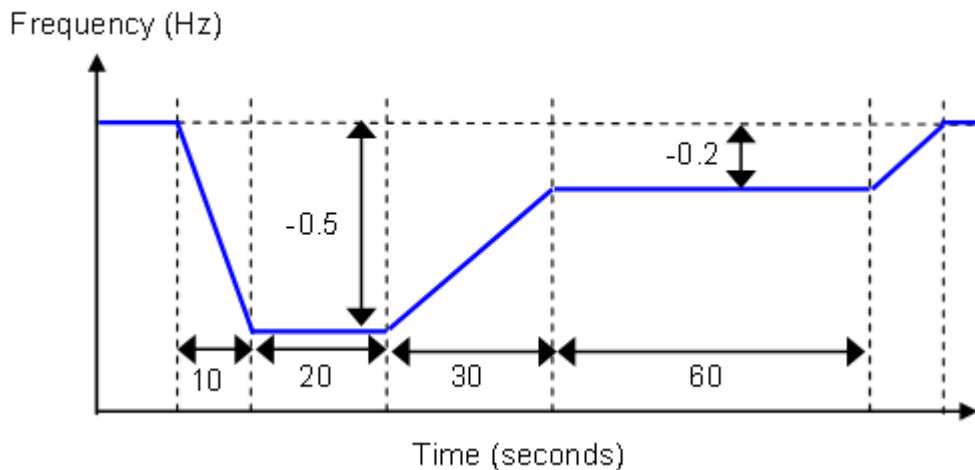

Figure CP.A.3.7.2

The simulation study shall show **Active Power** output (MW) and the equivalent of **Frequency** injected.

CP.A.3.7.3 To demonstrate the **Excitation System** model the **Generator** shall submit simulation studies representing the response of the **Synchronous Generating Unit** as follows:

- (i) operating open circuit at rated terminal voltage and subjected to a 2% step increase in terminal voltage reference.

- (ii) operating at **Rated MW**, nominal terminal voltage and unity power factor subjected to a 2% step increase in the voltage reference. Where a **Power System Stabiliser** is included within the **Excitation System** this shall be in service.

The simulation study shall show the terminal voltage, field voltage of the **Generating Unit**, **Active Power**, **Reactive Power** and **Power System Stabiliser** output signal as appropriate.

- CP.A.3.7.4 To demonstrate the Voltage Controller model the **Generator** or **DC Converter Station** owner shall submit a simulation study representing the response of the **Non-Synchronous Generating Unit**, **DC Converter** or **Power Park Module** operating at **Rated MW** and unity power factor at the connection point to a 2% step increase in the voltage reference. The simulation study shall show the terminal voltage, **Active Power**, **Reactive Power** and **Power System Stabiliser** output signal as appropriate.
- CP.A.3.7.5 To validate that the excitation and voltage control models submitted under the **Planning Code** are a reasonable representation of the dynamic behaviour of the **Synchronous Generating Unit**, **DC Converter Station** or **Power Park Module** as built, the **Generator** or **DC Converter Station** owner shall repeat the simulation studies outlined above but using the operating conditions of the equivalent tests. The simulation study results shall be displayed overlaid on the actual test results.
- CP.A.3.7.7 For **Generating Units** or **DC Converters** with a **Completion Date** after 1 January 2012 or subject to a **Modification** to the governor system or **Frequency** control system after 1 January 2013 to validate that the governor/load controller/plant or **Frequency** control models submitted under the **Planning Code** is a reasonable representation of the dynamic behaviour of the **Synchronous Generating Unit** or **DC Converter Station** as built, the **Generator** or **DC Converter Station** owner shall repeat the simulation studies outlined above but using the operating conditions of the equivalent tests. The simulation study results shall be displayed overlaid on the actual test results.

- CP.A.3.8 Sub-synchronous Resonance Control and Power Oscillation Damping Control for DC Converters
- CP.A.3.8.1 To demonstrate the compliance of the sub-synchronous control function with CC.6.3.16(a) and the terms of the **Bilateral Agreement**, the **DC Converter Station** owner or **Generator** undertaking **OTSDUW** shall submit a simulation study report.
- CP.A.3.8.2 Where power oscillation damping control function is specified on a **DC Converter** the **DC Converter Station** owner or **Generator** undertaking **OTSDUW** shall submit a simulation study report to demonstrate the compliance with CC.6.3.16(b) and the terms of the **Bilateral Agreement**.
- CP.A.3.8.3 The simulation studies should utilise the **DC Converter** control system models including the settings as required under the **Planning Code** (PC.A.5.3.2). The network conditions for the above simulation studies should be discussed with **NGET** prior to commencing any simulation studies.

< END OF COMPLIANCE PROCESSES >